

# STANISLAUS COUNTY PLANNING COMMISSION

November 15, 2018

## STAFF REPORT

### SPECIFIC PLAN, GENERAL PLAN AMENDMENT, AND REZONE APPLICATION NO. PLN2013-0091- CROWS LANDING INDUSTRIAL BUSINESS PARK

**REQUEST: REQUEST TO ADOPT A SPECIFIC PLAN, AMEND THE GENERAL PLAN DESIGNATION FROM AGRICULTURE TO SPECIFIC PLAN, AND REZONE FROM A-2 (GENERAL AGRICULTURE) TO S-P(2) (SPECIFIC PLAN) TO ALLOW FOR THE DEVELOPMENT OF A 1,528 ACRE SITE TO SUPPORT A MIX OF AVIATION-COMPATIBLE INDUSTRIAL AND BUSINESS PARK USES, GENERAL AVIATION, AVIATION-RELATED LAND USES, PUBLIC FACILITIES, A MULTIMODAL (BICYCLE/PEDESTRIAN) TRANSPORTATION CORRIDOR, AND SUPPORTIVE INFRASTRUCTURE.**

#### APPLICATION INFORMATION

Applicant:	Stanislaus County
Property owner:	Stanislaus County
Location:	Northwest corner of Fink and Bell Roads, east of Davis Road, south of W. Marshall Road, in the Crows Landing area
Section, Township, Range:	17/20-6-8 & 8-8-6
Supervisorial District:	Five (Supervisor DeMartini)
Assessor's Parcel:	027-001-057 to 059; and 027-003-074 to 080
Area of Parcel(s):	1,528 acres
Water Supply:	Public Water System
Sewage Disposal:	Interim Septic Systems and City of Patterson; or on-site Conveyance and Treatment System
Existing Zoning:	A-2-40 (General Agriculture)
General Plan Designation:	Agriculture
Sphere of Influence:	Not Applicable
Community Plan Designation:	Not Applicable
Williamson Act Contract No.:	Not Applicable
Environmental Review:	Environmental Impact Report (Certified October 30, 2018 – State Clearinghouse No. #2014102035)
Present Land Use:	Former Crows Landing Naval Air Facility and irrigated farmland.
Surrounding Land Use:	Agricultural land uses, with some rural residences in the vicinity, and the community of Crows Landing to the east.

## **RECOMMENDATION**

Staff recommends the Planning Commission recommend that the Board of Supervisors approve this request based on the discussion below and on the whole of the record provided to the County. If the Planning Commission decides to recommend approval of this project, Exhibit A provides an overview of all the findings required for project approval.

## **PROJECT AND SITE DESCRIPTION**

This is a request to adopt a Specific Plan allowing for the development of a 1,528 acre site to support a mix of aviation-compatible industrial and business park uses, general aviation, aviation-related land uses, public facilities, a multimodal (bicycle/pedestrian) transportation corridor, and supportive infrastructure. The project is anticipated to develop in three phases over 30 years with a 370 acre public-use airport and 14 million square feet of building space with the potential to generate approximately 14,000-15,000 jobs. The project includes a request to establish a Specific Plan for the project, amend the General Plan designation of Agriculture to Specific Plan and rezone from A-2-40 (General Agriculture) to S-P(2) (Specific Plan). Following adoption of the Specific Plan, subsequent development projects within the project site (Plan Area) will be reviewed for consistency and compliance with the Specific Plan and any other County regulations in effect at the time of development.

The proposed Specific Plan (October 2018), along with appendices, is provided as Exhibit C of this report and is available online at: <http://www.stancounty.com/planning/pl/act-projects.shtm>.

Since the initial public release of the draft Specific Plan on January 22, 2018, Chapter 4 – Infrastructure has been amended based on comments from the cities of Patterson and Newman, to reflect updated transportation information, and to provide for minor text clean-up. The October 2018 version of the proposed Specific Plan reflects these amendments.

The project site is located in an unincorporated portion of western Stanislaus County, approximately 1.5 miles east of Interstate 5 (I-5), and 2.5 miles west of the community of Crows Landing. The 1,528-acre property is bounded by W. Marshall Road to the north, State Route (SR) 33 to the northeast, Bell Road to the east, Fink Road to the south, and Davis Road and agricultural land to the west. (See Exhibit B – Maps.)

Nearly all structures associated with former military activities have been demolished. Remaining facilities include two decommissioned runways, an air traffic control tower (ATCT), and remnant roads. The Delta Mendota Canal (DMC) traverses the southern portion of the project site in a northwest-to-southeast direction. Since 2000, approximately 1,200 acres of the site have been leased for private agricultural uses. The property will remain in agricultural use until the land is needed for the construction of infrastructure and development in accordance with the Specific Plan.

## **PROJECT HISTORY AND OVERVIEW**

From the commissioning of the Crows Landing Air Facility (Air Facility) as an auxiliary airfield to Naval Air Station Alameda in 1942, until its decommissioning by the National Aeronautics and Space Administration (NASA) as the Crows Landing Flight Facility/NASA Ames Research Center in 1999, the military and civilian work force who lived and worked at the airfield proudly served our nation. The multiple missions and operations that occurred at the Air Facility brought new residents to Stanislaus County, contributed to the economic prosperity of the County, the Central Valley, the State of California, and to the security of our nation.

The end of the Cold War reduced military operations at Crows Landing, and the Department of Defense's Base Closure and Realignment Commission (BRAC) identified the airfield for closure during the 1990s. In 2004, the United States Congress passed Public Law 106-82, conveying the former military property to Stanislaus County. Since that time, the County has embraced the opportunity to reuse of the former airfield to benefit County residents and the region as a whole. For many years, the unemployment rate in Stanislaus County has been higher than the statewide average. Many jobs within the County do not provide wages that are sufficient to sustain a household, and residents seeking sustainable-wage jobs must commute to distant job centers outside of the County, frequently traveling to Sacramento and the San Francisco Bay Area (Bay Area). A 2014 analysis of commuting patterns in the North San Joaquin Valley, which includes San Joaquin, Stanislaus, and Merced Counties, indicated that approximately 23% of Stanislaus County's employed residents commuted outside of the County, of which, 9% commuted to Bay Area communities. The seven employment sectors with the highest proportion of residents traveling outside of the County to work were construction; transportation; warehousing; utilities; public administration; wholesale trade; and manufacturing.

The reuse of the former Crows Landing Air Facility through the development of the CLIBP is central to Stanislaus County's ongoing strategy to create sustainable-wage jobs for its residents and others living in nearby areas of the Northern San Joaquin Valley. The Specific Plan establishes the framework to implement that strategy. The objectives of the Specific Plan include:

1. Reuse the former Crows Landing Air Facility to develop a high quality, attractive industrial business park that makes a positive statement for the area and for Stanislaus County.
2. Create a regional employment center on the former Crows Landing Air Facility property, conveyed to Stanislaus County through Public Law 106-82, that will promote development and reduce greenhouse gas emissions by bringing jobs closer to County residents.
3. Create a center for light industrial, manufacturing, logistics, and aviation-related uses that will optimize the site's development potential based on its proximity to Interstate Highway 5 (I-5) and other potential regional, national, and international transportation facilities.
4. Provide for the development of on-site public administration and emergency service facilities to serve the site and Stanislaus County residents.
5. Provide for the phasing of on-site primary or "backbone" infrastructure, sufficient to enable "shovel-ready" on-site development opportunities within a logical progression on the site. Such infrastructure includes transportation/circulation, potable and non-potable water, wastewater, stormwater management, and dry utilities improvements.
6. Encourage development that incorporates sustainable site and infrastructure design and implements federal, state, and local energy and water conservation requirements.
7. Repurpose former military runway 12-30 to construct a general aviation airport to serve as an amenity for site users and the business and general aviation needs of Stanislaus County and the region.
8. Identify potential funding options to secure necessary site improvements.
9. Provide for an attractive business park that offers amenities for site workers such as on-site food service, automated banking opportunities, and outdoor pedestrian circulation/paths.
10. Honor the unique contributions of the former Crows Landing Air Facility and Stanislaus County to our nation's history, while looking ahead to improve the lives of the County's current and future residents.

Along with project objectives, the CLIBP Specific Plan identifies goals and policies for land use, design and development standards, and infrastructure/utilities such as, water system, wastewater, stormwater management, dry utilities, and solid waste facilities. The Specific Plan is organized into the following chapters:

**Chapter 1 - Introduction**, which provides an overview of the Specific Plan purpose, objectives, use, content, relationship to other local and regional plans, and other general information.

**Chapter 2 - Land Uses**, which describes the categories of permitted land uses and the character of development within the Plan Area, project phasing, and the goals and policies that inform the Specific Plan content.

**Chapter 3 - Built Environment and Design**, which includes site-specific objectives and policies for the baseline design features that will define the built environment for the CLIBP.

**Chapter 4 - Infrastructure**, which addresses the infrastructure required for development (i.e., facilities for potable and non-potable water, wastewater, stormwater management, transportation/circulation, and dry utilities).

**Chapter 5 - Specific Plan Implementation**, which addresses the administration of the Specific Plan and includes implementation procedures to ensure that on-site development projects will support the orderly development of the Plan Area in coordination with the provision of the necessary infrastructure and services.

The Specific Plan anticipates the project to develop in three consecutive 10 year phases over a 30 year timeframe to achieve project buildout. A phasing map, Figure 2-2 of the Specific Plan, is also available as Exhibit B of this report. (See Exhibit B – *Maps*.) The phases as proposed are:

**Phase 1:** The Fink and Bell Road Corridors which encompass the airport and the portion of the project site located south of the airport and north of Fink Road, and a portion of the Public Facilities Area. Phase 1 contains Phase 1A and Phase 1B. Phase 1A, the Fink Road Corridor, contains 103 acres and is expected to develop between 2019-2022. Phase 1B, the Bell Road Corridor, contains 661 acres which includes the airport, a portion of the Public Facilities Area, and the W Ike Crow/Bell Road entrance to the project site and is expected to develop between 2023 and 2028. The County will design, engineer, and oversee the construction of backbone infrastructure needed to support proposed development in Phase 1A.

**Phase 2:** The State Route (SR) 33 Corridor (South) is located mid-property, includes a portion of the Public Facilities Area as well as land designated for airport-related uses, the stormwater pond, and a strip of developable area adjacent to W. Marshall Road. Phase 2 includes 236 acres and is expected to develop between 2029-2038.

**Phase 3:** SR 33 Corridor (North) is flanked by Phase 2 to the north, east, and south and includes the remaining 11 acres of the Public Facilities Area currently in remediation due to the presence of contaminated water. Phase 3 encompasses 274 acres and is expected to develop between 2039-2048.

Since the initial public release of the Specific Plan on January 22, 2018, the phasing time frames reflected above have changed from the time frames listed on Page 2-1 of the Specific Plan. Staff is requesting that the Planning Commission recommend that the Board of Supervisors update the phasing to accurately reflect the corrected time frames, as detailed above. A recommendation to address this matter has been added to Exhibit A of this report.

The Specific Plan identifies a suite of general land use types. As shown in Table 2-1 (below) on page 2-4 of the Specific Plan, seven land use categories were identified for development on the

project site. Table 2-1 lists anticipated development and phasing by land use category and phase (acres):

<b>Table 2-1: Anticipated Development and Phasing by Land Use Category and Phase (acres)</b>						
<b>Land Use</b>	<b>Description</b>	<b>Phase 1</b>		<b>Phase 2</b>	<b>Phase 3</b>	<b>Total All Phases</b>
		<b>1A</b>	<b>1B</b>			
<b>Logistics/Distribution</b>	Packaging, warehouse, and distribution, etc.	52	138	57	102	<b>349</b>
<b>Light Industrial</b>	Light industrial manufacturing, machine shops, etc.	41	110	71	128	<b>350</b>
<b>Business Park</b>	Research and development, business support services, etc.	10	28	14	26	<b>78</b>
<b>Public Facilities</b>	Government offices, professional offices, emergency services, etc.	0	15	35	18	<b>68</b>
<b>General Aviation</b>	Airport runways, aprons, hangars, etc.	0	370	0	0	<b>370</b>
<b>Aviation Related</b>	Parcel distribution, aviation classroom training, etc.	0	0	46	0	<b>46</b>
<b>Multimodal Transportation Corridor/Green Space</b>	Bicycle and pedestrian trail, greenway, monument to military use.	0	0	13	0	<b>13</b>
<b>All Uses by Phase</b>		<b>103</b>	<b>661</b>	<b>236</b>	<b>274</b>	<b>1,274</b>
<b>Infrastructure</b>	Internal roadways, water and wastewater systems, stormwater drainage, etc.					<b>254</b>
<b>Plan Area Total</b>						<b>1,528</b>

**Appendix A** of the Specific Plan provides a land use and employment summary for the CLIBP project based on phases. The summary estimates 14 million square feet of building area development to support approximately 14,447 total employees based on available developable acreage and floor to area ratios for the various land uses.

**Appendix B** of the Specific Plan provides the permitted land uses and design and development standards for the CLIBP project. Table B-1 – CLIBP S-P(2) Zone Permitted Use Table of Appendix B identifies uses by land use category and land use area. The specific uses in Table B-1 correspond to the broader land use categories identified in the Specific Plan, subject to compliance with adopted design and development standards. A proposed land use that is not identified as permitted in Table B-1 may be allowed if it is determined by the Planning Director, or his/her designee, to be similar in nature to a permitted use and is consistent with the Stanislaus County Airport Land Use Compatibility Plan (ALUCP). Any use identified as a potential hazard to aircraft operations shall be prohibited.

The design and development standards of the CLIBP, as provided for in Appendix B of the Specific Plan, include: general performance standards, development standards by land use, site planning standards, streetscape/landscape standards, building and architectural standards, parking standards, signage standards, and property maintenance standards.

Together all chapters, as summarized on page 4 of this report, and appendices serve as a development blueprint for the Crows Landing Industrial Business Park. However, Specific Plan Chapters 3 and 5, as outlined below, and Appendix B of the Specific Plan will be core documents used by the County to: review development projects submitted for site plan and building permit review and articulate the development/entitlement process for individual leaseholder and/or projects in pre-development meetings.

**Chapter 3** – Built Environment and Design, of the Specific Plan, shall be referenced in coordination with the design and development standards to assist future applicants, County staff, the Planning Commission, and Board of Supervisors in evaluating development proposals. Exceptions from the design and development standards in Appendix B may be permitted if determined by the Planning Director or his/her designee to provide a substantially consistent design approach that is equal in quality and design and meets the intent of the original standard.

**Chapter 5** – Implementation of the Specific Plan outlines the procedures to be used to implement the CLIBP project during the anticipated 30 year build-out period. The purpose of the implementation procedures is to ensure that on-site development projects will support the orderly development of the CLIBP project in coordination with the provisions of the necessary infrastructure and services and provide sufficient flexibility to respond to fluctuations in economic and market demand.

The on-site and off-site public improvements and development of the project site includes the provision of public utilities. To address this requirement, all necessary studies and infrastructure master plans (water, sewer, stormwater, and traffic), which are incorporated as appendices to the Specific Plan, were prepared to facilitate development of the Specific Plan and will be approved with adoption of the Specific Plan. The following are the infrastructure options for the project:

- Wastewater Treatment – The County has planned a new sewer collection system that will connect to the City of Patterson Water Quality Control Facility (WQCF) to treat project wastewater, with limited interim use of septic systems during initial site development. If the County determines this option is not feasible, an on-site conveyance and treatment option will be developed.

The process for design, permitting, and construction for expansion of the City's WQCF could take up to 12 years. Depending on timing of development in Phases 1 and 2, the County may need to construct a temporary on-site septic system (temporary package treatment plant or other suitable option) to accommodate wastewater needs for part, or all, of Phase 1 and part of Phase 2 development. Once all necessary approvals are obtained and expansion is completed, the County could subsequently connect to the City of Patterson's system.

- Water Supply (Potable and Non-Potable) – The County will explore three alternatives and select a preferred alternative prior to initiation of Phase 1:
  - Option 1: Extend the Crows Landing Community Services District (CSD) service area to include the Project to enable the development of a shared water system under the CSD's existing drinking water supply permit;

- Option 2: Obtain a new water supply permit to enable the County to develop a standalone water supply for the Project; or,
  - Option 3: Extend the City of Patterson's water service area to include the Project under its existing drinking water supply permit.
- Stormwater Drainage – The project proposes to widen Little Salado Creek, which traverses the site from south to north, and widen and replace culverts crossing under Runway 12-30, construct a stormwater management pond along the northeastern boundary of the Project site, and other measures, such as Low Impact Development (LID) standards, are identified to manage stormwater runoff, while allowing for groundwater recharge.

The on-site and off-site public improvements necessary to serve the Project will be designed by the County to accommodate the envisioned development. Plans will include an infrastructure sequencing program that will coordinate with and allow for orderly development throughout Project buildout. Building permits will not be issued until the County's Public Works Director determines that improvement plans are complete (engineered and approved) and found to be consistent with the Project's Specific Plan and Financing Plan.

Public improvements, including off-site improvements, will either be installed by the County or by other public agencies with responsibility for those improvements. A fee will be developed to reimburse the upfront costs of each phase of development as it occurs. Should the County decide that a Master Developer would be desirable, a development agreement (DA) will be executed with the master developer. The DA would set out the requirements for the roles and responsibilities of each party.

## **ISSUES**

The Specific Plan was developed in coordination with the Airport Land Use Compatibility Plan (ALUCP) to ensure consistency and compatibility between both documents. An Environmental Impact Report (EIR) providing an environmental analysis of both the Specific Plan and the ALUCP was certified by the Board of Supervisors on October 30, 2018. An overview of the EIR and environmental issues raised regarding the project are provided in the Environmental Review section of this report. No issues of concern specific to this Planning Commission item have been raised.

## **GENERAL PLAN CONSISTENCY**

The Stanislaus County General Plan's Land Use Diagram designates the CLIBP Plan Area as Agricultural. This application requests re-designating the site from Agriculture to Specific Plan. The intent of the Specific Plan designation is to create a detailed plan for a specific area of the County. It is guided by and must conform to the General Plan, but its scale permits a relatively detailed level of examination and planning not normally possible in the General Plan. It is appropriate where major new development or redevelopment is envisioned and in locations that are: rapidly urbanizing areas with significant new demand for public facilities and services; unique physical conditions; complex mixture of uses proposed; multiple ownership in complex developing area; a marginal or deteriorated area that needs revitalization; large industrial and/or commercial complexes; very large single-ownership land developments where a significant new community is to be developed in a presently non-urban area; and in special study areas.

The proposed Specific Plan has been developed in accordance with the County's adopted Specific Plan guidelines and is consistent with the maps, goals, and policies of the General Plan.

Goal 3, Policy 18 of the Land Use Element of the General Plan directs the County to “promote diversification and growth of the local economy” and Implementation Measure 9 of the General Plan, which is associated with this policy, states “encourage reuse of the Air Facility as a regional jobs center.” The Specific Plan further supports Policy 18 and implements Measure 9 of the General Plan by describing development specifically for the CLIBP Plan Area including policies, zoning, permitted uses, and design and development standards. Likewise, the Specific Plan was designed to comply with the ALUCP and to avoid conflicts between adjacent land use designations and zoning districts (Goal 1, Policy 1, Implementation Measure 2 of the Land Use Element).

Similarly, due to the proximity of I-5 and Highway 33, the Specific Plan complies with Policy 22 and Implementation Measure 1 of the Land Use Element, “Support and facilitate efforts to develop and promote economic development and job creation centers throughout the County. While supporting efforts to direct economic development and job creation centers towards incorporated areas, the County shall also consider approval of centers in unincorporated areas of unique character and proximity to transportation infrastructure.”

To minimize conflicts between agriculture operations and non-agricultural operations, the Specific Plan incorporates Buffer and Setback Guidelines (Appendix VII-A of the Agricultural Element). The purpose of the Buffer and Setback Guidelines is to protect the long-term health of local agriculture by minimizing conflicts, usually through the implementation of setbacks, vegetative screening, and fencing, resulting from normal agricultural practices as a consequence of new or expanding uses approved in or adjacent to the A-2 (General Agriculture) zoning district. As such, Appendix B of the Specific Plan establishes mandatory site edges and agricultural buffers in areas adjacent to off-site agricultural uses in accordance with Appendix A, Buffer and the Setback Guidelines.

The Specific Plan was designed to ensure compatibility between industrial and agriculture land uses, (Goal 2, Policy 14, Implementation Measures 1 and 2). Implementation of the aforementioned Agricultural Buffer standards reduces the potential for conflicts and ensures consistency with the Agricultural Element’s conversion criteria. That criteria permits the conversion of agricultural land to urban uses if the Board of Supervisors determines the proposed project has incorporated all reasonable measures, as determined during the environmental review process, to mitigate identified impacts and make all findings necessary to approve the project. (See Exhibit A - *Findings and Actions Required for Project Approval*.)

### **ZONING ORDINANCE CONSISTENCY**

Zoning districts are required to be consistent with the General Plan. To ensure consistency the County must amend the site’s General Plan designation from Agriculture to Specific Plan, and rezone the property from A-2 (General Agriculture) to S-P(2) (Specific Plan) to reflect the proposed land uses associated with the CLIBP Specific Plan. The CLIBP is only the County’s second Specific Plan. The first Specific Plan is Diablo Grande. The intent of the Specific Plan designation is to create a detailed plan for a specific area of the County which in turn allows for the development of design standards and guidelines specific to the Plan Area and the uses proposed. In essence, the Specific Plan designation, zoning, and resulting design standards and guidelines serves as a site specific zoning ordinance chapter while maintaining consistency with and being subject to all applicable codes within the County Zoning Ordinance and General Plan.

The proposed S-P(2) designation does not identify specific parcels for development; instead, this designation is intended to facilitate the creation of variably sized parcels that can be developed to meet the needs of individual leaseholders in accordance with the Specific Plan.



The design and development standards of the Specific Plan supplement the Stanislaus County Zoning Code and will serve as the zoning regulations governing development, improvement, and construction within the Plan Area. Where a standard is not provided in the Specific Plan, the standards of the County's Zoning Code and/or Standards and Specifications shall apply. The standards of Appendix B of the Specific Plan shall supersede and take precedence over conflicting County Zoning Code standards and/or Standards and Specifications governing the Plan Area.

## **ENVIRONMENTAL REVIEW**

Pursuant to the California Environmental Quality Act (CEQA), an EIR was prepared for the CLIBP Project and associated update to the ALUCP. The Notice of Availability for the 45-day Public Review Period of Draft EIR (DEIR) was issued on January 22, 2018, and was scheduled to end on March 12, 2018; however, the City of Patterson submitted a request to extend the review period. The County granted the request and provided an additional 45-day public review period for the DEIR that ended on April 26, 2018, for a total public review period of 90 days. The Final EIR (FEIR), was issued on October 18, 2018. The FEIR includes: a full list of agencies, organizations, and individuals that provided comments on the DEIR; verbatim comments received on the DEIR; response to the comments received; and minor revisions to the DEIR detailed in Chapter 3 of the FEIR. The FEIR is included as Attachment 4 – Final Environmental Impact Report of the October 30, 2018 Stanislaus County Board of Supervisors item approving certification of the EIR. The October 30, 2018 report is available online: <http://www.stancounty.com/bos/agenda/2018/20181030/DIS01.pdf>.

As part of the EIR Certification, the Board of Supervisors adopted Findings and Statement of Overriding Considerations, and adopted a Mitigation Monitoring and Reporting Program (MMRP) for the CLIBP Specific Plan and associated update to the ALUCP for which all future development associated with the CLIBP Project shall comply.

The following paragraphs summarize the mitigation measures added and incorporated into the project to prevent and reduce potentially significant impacts to a level of less than significant:

- **Air Quality:** Comply with Indirect Source Rule (ISR); use current phase construction equipment; reduce the single occupant vehicle commute; and assess Toxic Air Contaminants (TAC) and health risks and take actions to reduce such risks, if necessary.
- **Biological Resources:** Conduct plant survey (Little Salado Creek and the willow scrub community); avoid direct loss to raptors (Swainson's Hawk, Burrowing Owl, Tricolored Blackbird, and Loggerhead Shrike); prepare Swainson's Hawk foraging habitat mitigation plan; avoid loss of Pallid Bat – roosts and wildlife nursery sites (located within the former air traffic control tower); and compensate for loss of federally protected waters of the U.S.
- **Cultural Resources:** Protect previously undiscovered archaeological resources.
- **Geology, Soils, Mineral, and Paleontological Resources:** Prepare geotechnical reports; monitor earthwork during earthmoving activities; conduct subsidence monitoring; prepare and implement grading and erosion control plans; and avoid paleontological resources impacts.
- **Hazards and Hazardous Materials:** Prepare and implement a worker health and safety plan and minimize potential exposures to hazardous materials; remove asbestos and lead-based paint according to regulations; avoid landfill material (I-5/Fink Road); perform environmental site assessment (off-site AL Castle Site – seed processor); construction traffic plan; and designate an official truck route.
- **Hydrology and Water Quality:** Prepare and implement: stormwater pollution and prevention plan and associated best management practices, drainage plan, stormwater quality management plan; provide agreement for maintenance, monitoring, and funding for long-term

operational stormwater quality control; provide shallow well setbacks; conduct and report groundwater level monitoring; prepare hydraulic studies for water crossings; and prepare site specific levee design report and implement (Davis Road Levee).

- **Noise and Vibration:** Implement noise and vibration measures from construction traffic: truck route plan, equipment setback, phased construction activities, limit construction hours; use rubberized asphalt material; placement and orientation of day care uses; and implement construction equipment noise reduction mitigation.
- **Traffic and Transportation:** Provide off-site traffic signal or roundabout installations and intersection improvements; and off-site widening to four lanes on Marshall Road (project entrance to State Route 33).
- **Utilities and Service Systems:** Demonstrate adequate wastewater treatment capacity and provide fair-share funding to support capacity expansion, as necessary (City agreement in writing for use of WQCF required).

Potentially significant impacts that cannot be mitigated or cannot be mitigated to a level of less than significant were identified as significant and unavoidable impacts. The following list summarizes the significant and unavoidable impacts:

- **Aesthetics:** Visual character of the project site and surroundings; increase in nighttime lighting and daytime glare and cumulative effects.
- **Air Quality:** Short-term construction and long-term operational emissions and consistency with air quality attainment planning.
- **Agricultural Resources:** Loss of important farmland and conversion of agricultural land and cumulative agricultural resources effects.
- **Greenhouse Gas Emissions:** Increases in greenhouse gas emissions (cumulatively considerable).
- **Land Use, Population, and Housing:** Induced population growth.
- **Noise and Vibration:** Short-term exposure of sensitive receptors to construction noise.
- **Traffic and Transportation:** Existing plus project – intersection operations (facilities outside of County control) and cumulative congestion impacts.
- **Utilities and Service Systems:** Environmental impacts associated with increased demand at City of Patterson WQCF and cumulative utilities impacts.

In response to comments made by the City of Newman at the October 30, 2018, meeting regarding four specific intersections within the City of Newman (State Route (SR) 33 and Stuhr Road, Jensen Road, Yolo Street, and Inyo Street) and the need for the County to pay their fair share for intersection improvements, the Board of Supervisors approved an amendment to Mitigation Measure – Cumulative with Project Transportation 1: Traffic Signal Installation. The amendment added the language “in coordination with the City of Newman,” to ensure that the City’s concerns were addressed. This amendment is reflected in Exhibit D – *Mitigation Monitoring and Reporting Program* of this report. The adopted MMRP will be incorporated as Appendix L of the proposed CLIBP Specific Plan.

In accordance with CEQA Guidelines (Section 15162(a)(1)-(3)), when an EIR has been certified or a negative declaration adopted for a project, no subsequent EIR shall be prepared for that project unless the lead agency determines, on the basis of substantial evidence in the light of the whole record, one or more of the following apply:

1. Substantial changes are proposed in the project which will require major revisions of the previous EIR or negative declaration due to the involvement of new significant environmental effects or a substantial increase in the severity of previously identified significant effects;

2. Substantial changes occur with respect to the circumstances under which the project is undertaken which will require major revisions of the previous EIR or negative declaration due to the involvement of new significant environmental effects or a substantial increase in the severity of previously identified significant effects; or
3. New information of substantial importance, which was not known and could not have been known with the exercise of reasonable diligence at the time the previous EIR was certified as complete or the negative declaration was adopted, shows any of the following:
  - A. The project will have one or more significant effects not discussed in the previous EIR or negative declaration;
  - B. Significant effects previously examined will be substantially more severe than shown in the previous EIR;
  - C. Mitigation measures or alternatives previously found not to be feasible would in fact be feasible and would substantially reduce one or more significant effects of the project, but the project proponents decline to adopt the mitigation measure or alternative; or,
  - D. Mitigation measures or alternatives which are considerably different from those analyzed in the previous EIR would substantially reduce one or more significant effects on the environment, but the project proponents decline to adopt the mitigation measures or alternative.

No substantial changes were made to the project, nor new information involving new or substantially more severe significant environmental effects than were previously identified in the EIR since the October 30, 2018, public meeting were identified. As such, the Board of Supervisors' certified EIR for the CLIBP Specific Plan and associated update to the ALUCP remains adequate.

\*\*\*\*\*

Contact Person: Rachel Wyse, Senior Planner, (209) 525-6330

Attachments:

Exhibit A - Findings and Actions Required for Project Approval  
Exhibit B - Maps  
Exhibit C - Draft Final Specific Plan with Appendices (October 2018)\*  
Exhibit D - Mitigation Monitoring and Reporting Program (as adopted by the Board of Supervisors on October 30, 2018)

\*Note: The Specific Plan is available for review online: [http://www.stancounty.com/planning/pl/act-proj/pln2013-0091\\_specific-plan.pdf](http://www.stancounty.com/planning/pl/act-proj/pln2013-0091_specific-plan.pdf) and a hard copy is also available for review at the County's Planning and Community Development Department located at 1010 10<sup>th</sup> Street, Suite 3400, Modesto, CA, 95354. Hard copies of the Specific Plan, in its entirety, have been provided to each member of the Planning Commission.

## Findings and Actions Required for Project Approval

The proposed project must obtain approval from the Stanislaus County Board of Supervisors. The Planning Commission may make a recommendation to the Board. Should the Commission support the project, the Commission may recommend the following to the Board of Supervisors:

1. Conduct a Public Hearing to consider Specific Plan, General Plan Amendment and Rezone Application No. PLN2013-0091, Crows Landing Industrial Business Park, to adopt a Specific Plan, amend the General Plan designation from Agriculture to Specific Plan, and rezone from A-2-40 (General Agriculture) to Specific Plan to allow for development of a 1,528 acre site to support a mix of aviation-compatible industrial and business park uses, general aviation, aviation-related land uses, public facilities, a multimodal (bicycle/pedestrian) transportation corridor, and supportive infrastructure and a 370 acre public-use airport, located at the northwest corner of Fink and Bell Roads, in the Crows Landing area.
2. Find that on October 30, 2018, the Board of Supervisors, acting as Lead Agency, certified the Environmental Impact Report (EIR) for the Crows Landing Industrial Business Park Specific Plan and associated updates to the Stanislaus County Airport Land Use Commission Plan (the "Project") in accordance with the California Environmental Quality Act (CEQA), adopting the Findings and Statement of Overriding Considerations and adopted the Mitigation Monitoring and Report Program (MMRP) for the Project, and find that all mitigation measures as reflected in the adopted MMRP have been incorporated into the CLIBP Specific Plan.
3. Find that on the basis of substantial evidence in light of the whole record, none of the conditions identified in CEQA Guidelines section 15162 or 15163 have occurred to necessitate preparation of a Subsequent EIR or Supplemental EIR.
4. Find that the Project is considered a Water Demand Project in accordance with CEQA Section 15155(a)(1) and the County conducted a water supply assessment in compliance with Senate Bill 610 and will explore three alternatives and select a preferred alternative prior to the initiation of Phase 1 of the Project.
5. Order the filing of a Notice of Determination with the Stanislaus County Clerk Recorder pursuant to Public Resources Code Section 21152 and CEQA Guidelines Section 15075.
6. Find that the CLIBP Specific Plan:
  - (a) Is consistent with the maps, goals, and policies of the adopted Stanislaus County General Plan.
  - (b) Helps to achieve a balanced community to promote health, safety, and general welfare.
  - (c) Results in development of character which will not be detrimental to existing and proposed development in the surrounding area.
  - (d) Contributes to a balance of land uses so that local residents may work and have available services and goods from the larger community in which they live.

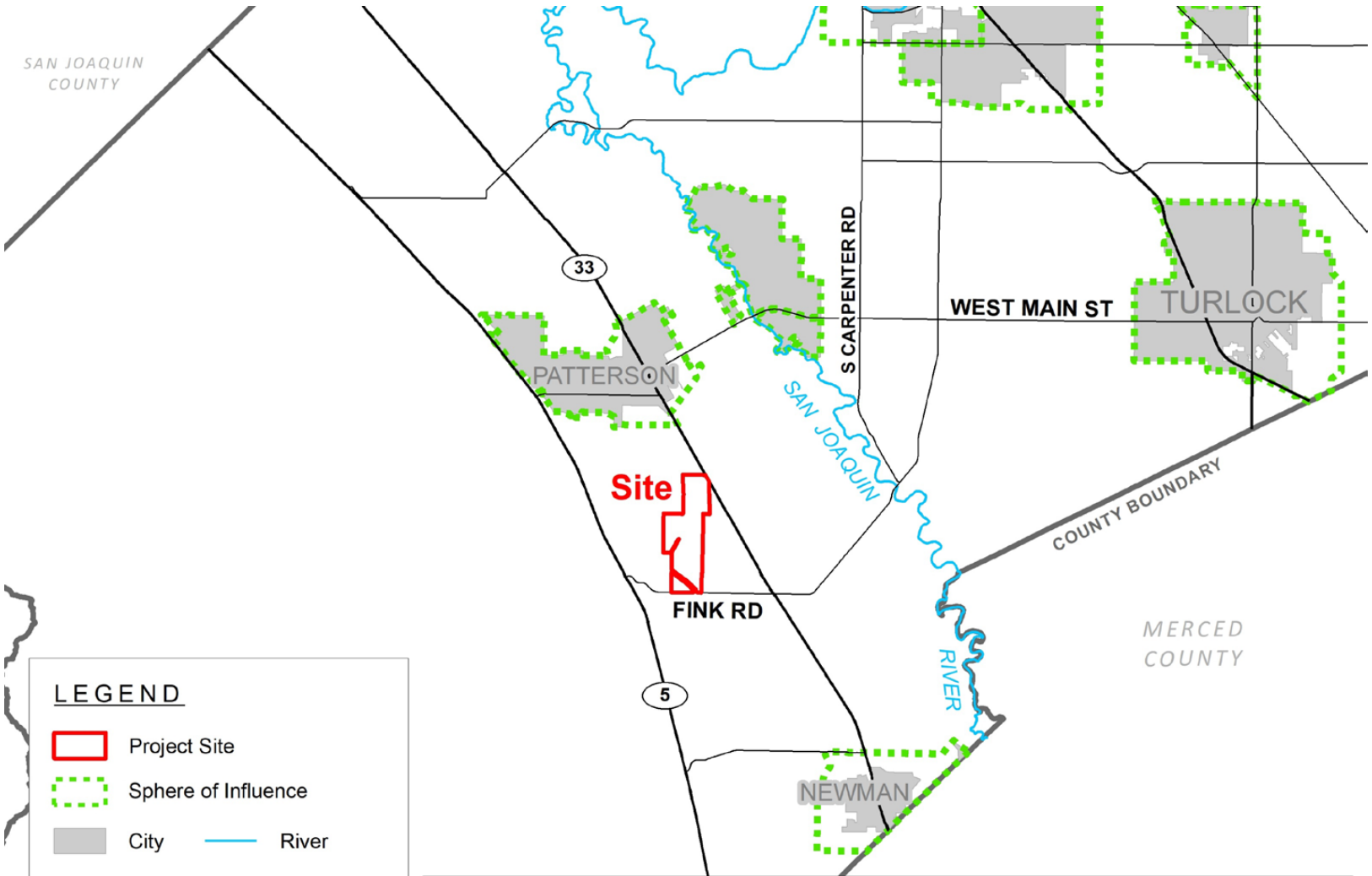
- (e) Addresses the environmental and aesthetic assets of the community.
- (f) Demonstrates long-term and short-term availability of those services necessary to serve the development and they will be provided at no net expense to public agencies.
- (g) Demonstrates a design superior to that which could be attained through traditional permit process by promoting the development of land uses, through the reuse of the Crows Landing Industrial Navel Facility, that will support job creation providing for local employment opportunities, including opportunities for residents of Stanislaus County, some of whom may be currently unemployed or commuting to job sites located outside of the County.

7. Find that:

- (a) The General Plan amendment will maintain a logical land use pattern without detriment to existing and planned land uses.
- (b) The County and other affected government agencies will be able to maintain levels of service consistent with the ability of the government agencies to provide a reasonable level of service.
- (c) The General Plan amendment is consistent with the General Plan goals and policies.
- (d) Overall, the CLIBP Specific Plan is consistent with the goals and policies of the General Plan.
- (e) There is evidence on the record to show a demonstrated need for the CLIBP Specific Plan based on population projections, past growth rates, and other pertinent data.
- (f) No feasible alternative site exists in areas already designated for the CLIBP Specific Plan uses.
- (g) Approval of the CLIBP Specific Plan will not constitute a part of, or encourage, piecemeal conversion of a larger agricultural area to non-agricultural uses.
- (h) The CLIBP Specific Plan is designed to minimize conflict and will not interfere with agricultural operations on surrounding agricultural lands or adversely affect agricultural water supplies.
- (i) Adequate and necessary public services and facilities are available or will be made available as a result of the development.
- (j) The design of the proposed project has incorporated all reasonable measures, as determined during the environmental review process, to mitigate impacts to agricultural lands, fish and wildlife resources, air quality, water quality and quantity, or other natural resources.

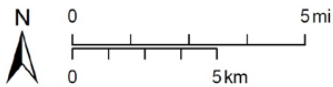
- (k) The proposed S-P(2) (Specific Plan) zoning is consistent with the Specific Plan General Plan designation.
  - (l) The Airport Layout Plan and Narrative Report, Appendix D of the CLIBP Specific Plan, is consistent with the CLIBP Specific Plan.
  - (m) Overall, the CLIBP Specific Plan will be consistent with the goals and policies of the Airport Land Use Compatibility Plan as amended.
  - (n) The CLIBP Specific Plan will increase activities in and around the project area, and increase demands for roads and services, thereby requiring dedication and improvement.
8. Approve Specific Plan, General Plan Amendment and Rezone Application No. PLN2013-0091, Crows Landing Industrial Business Park, as recommended by the Planning Commission, including an update the project phasing timelines as outlined in the November 15, 2018 Planning Commission Staff Report.
  9. Introduce, waive the reading, and adopt an ordinance for the approved Rezone Application No. PLN2013-0091, Crows Landing Industrial Business Park.

SAN JOAQUIN  
COUNTY



**LEGEND**

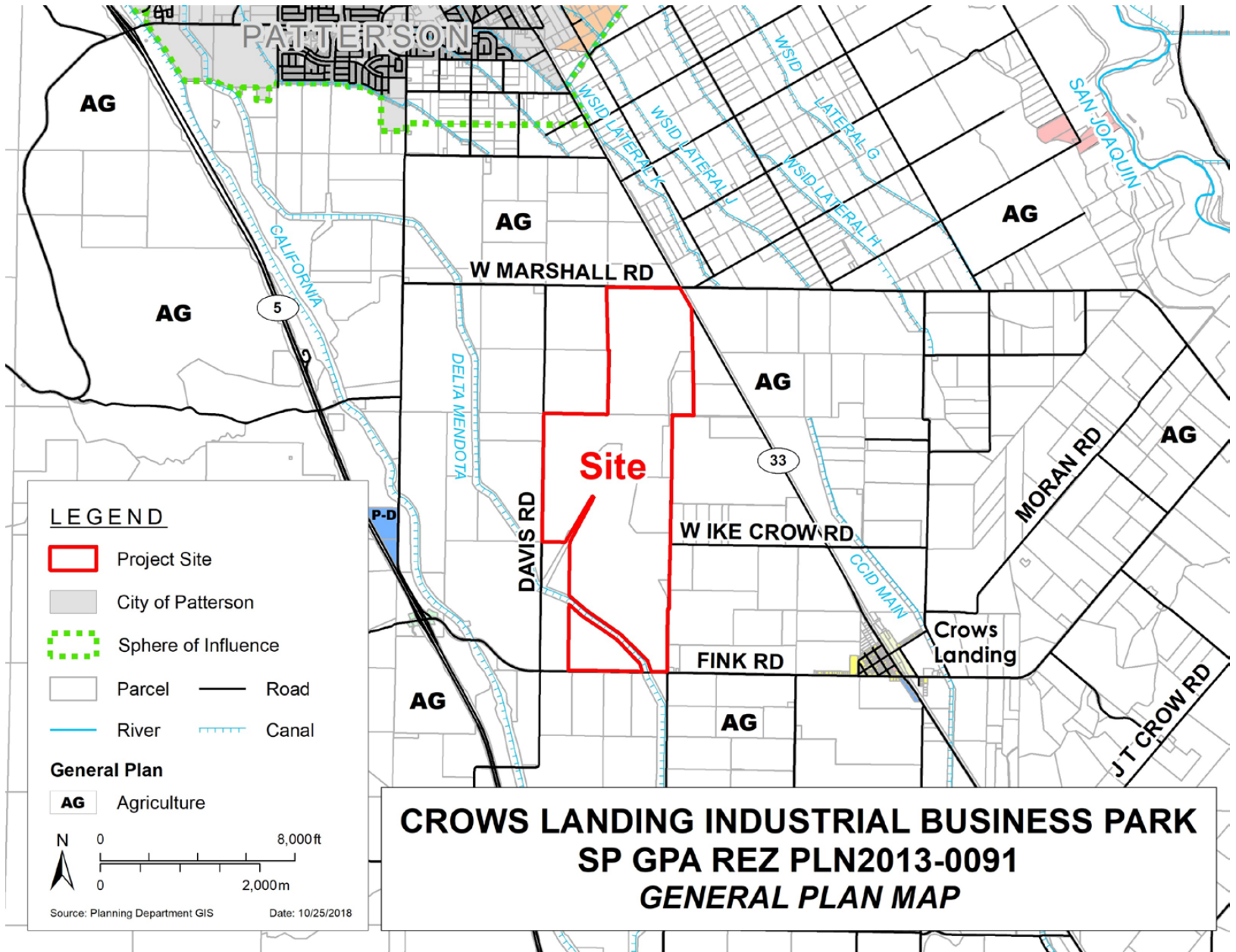
-  Project Site
-  Sphere of Influence
-  City
-  River
-  Road



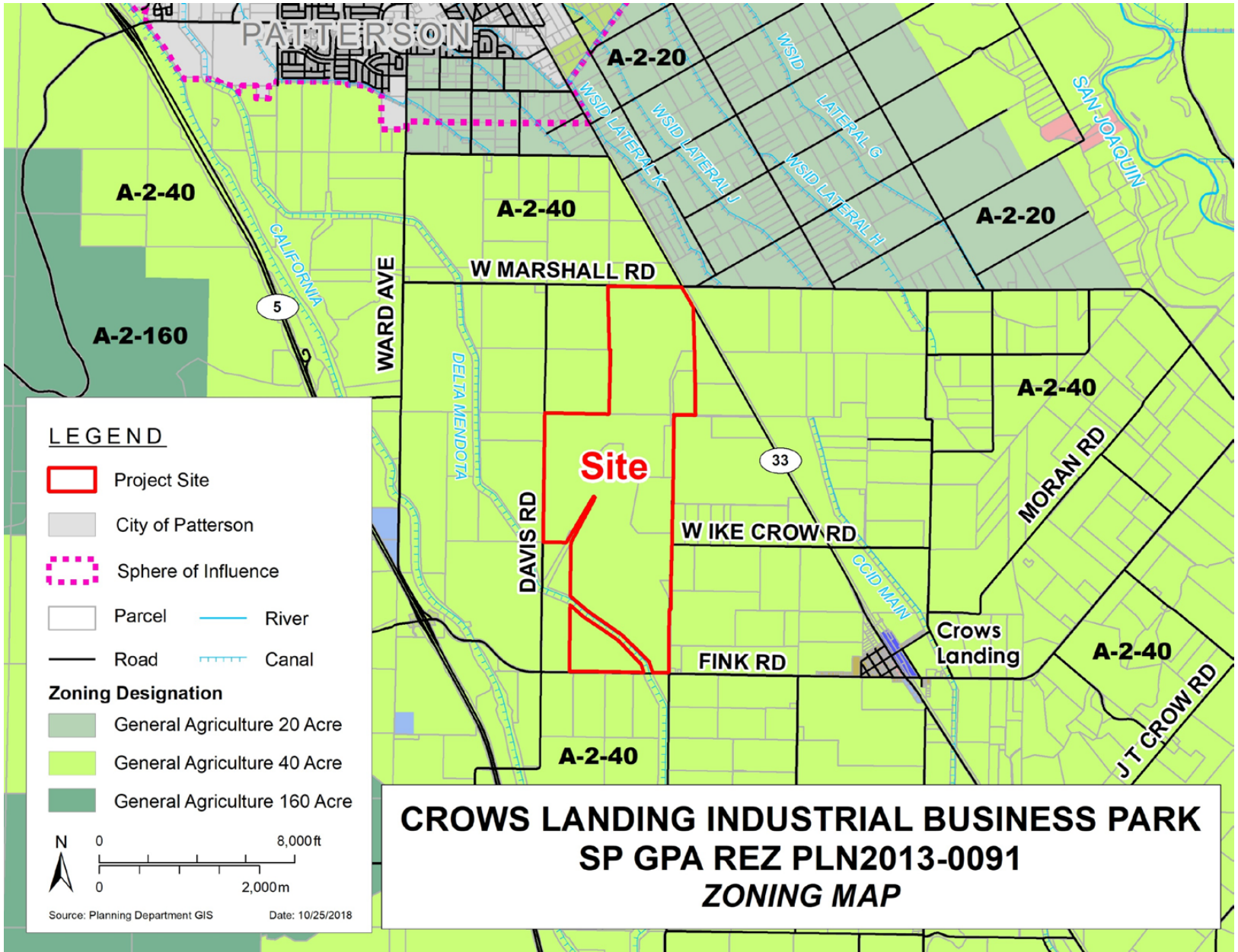
Source: Planning Department GIS

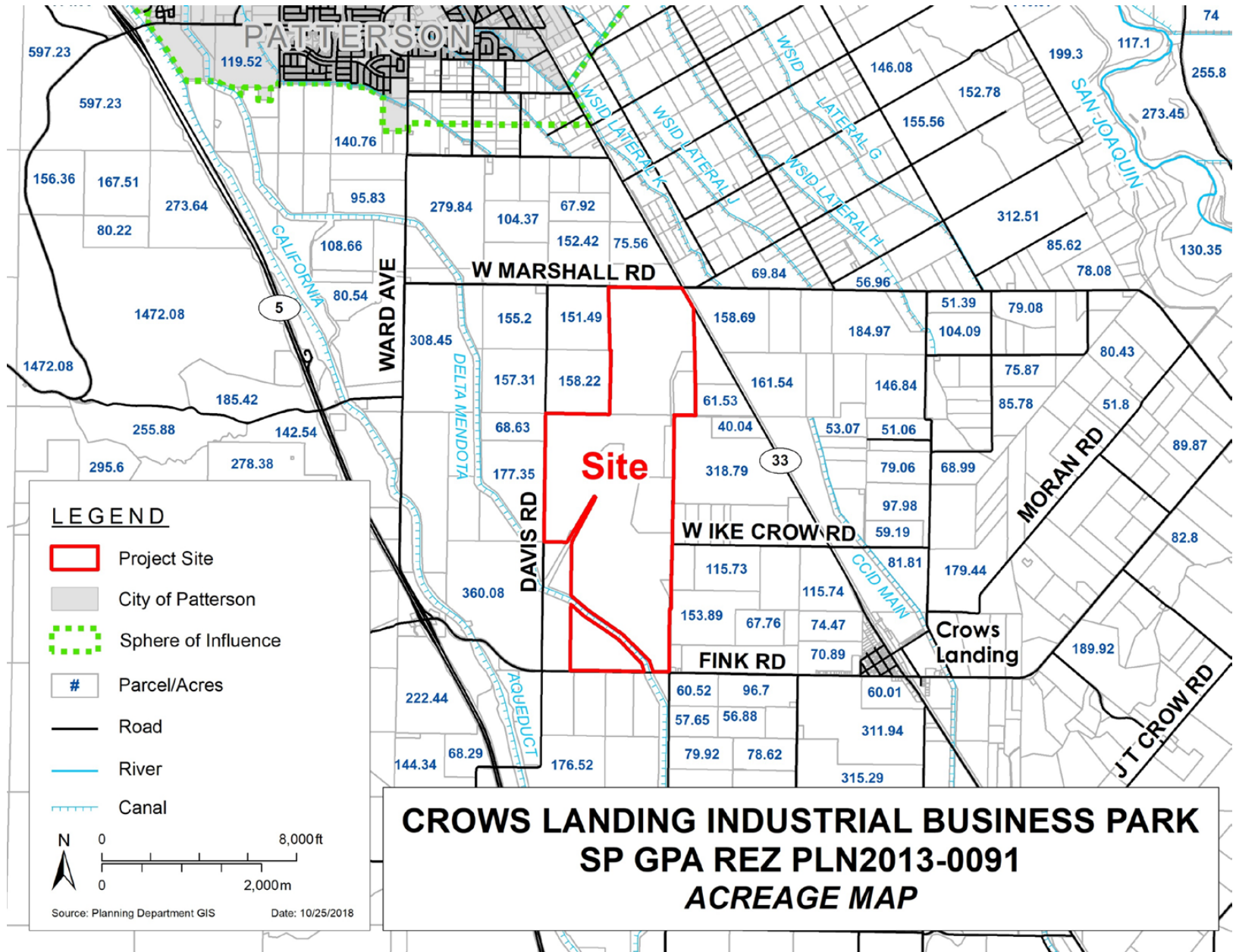
Date: 10/25/2018

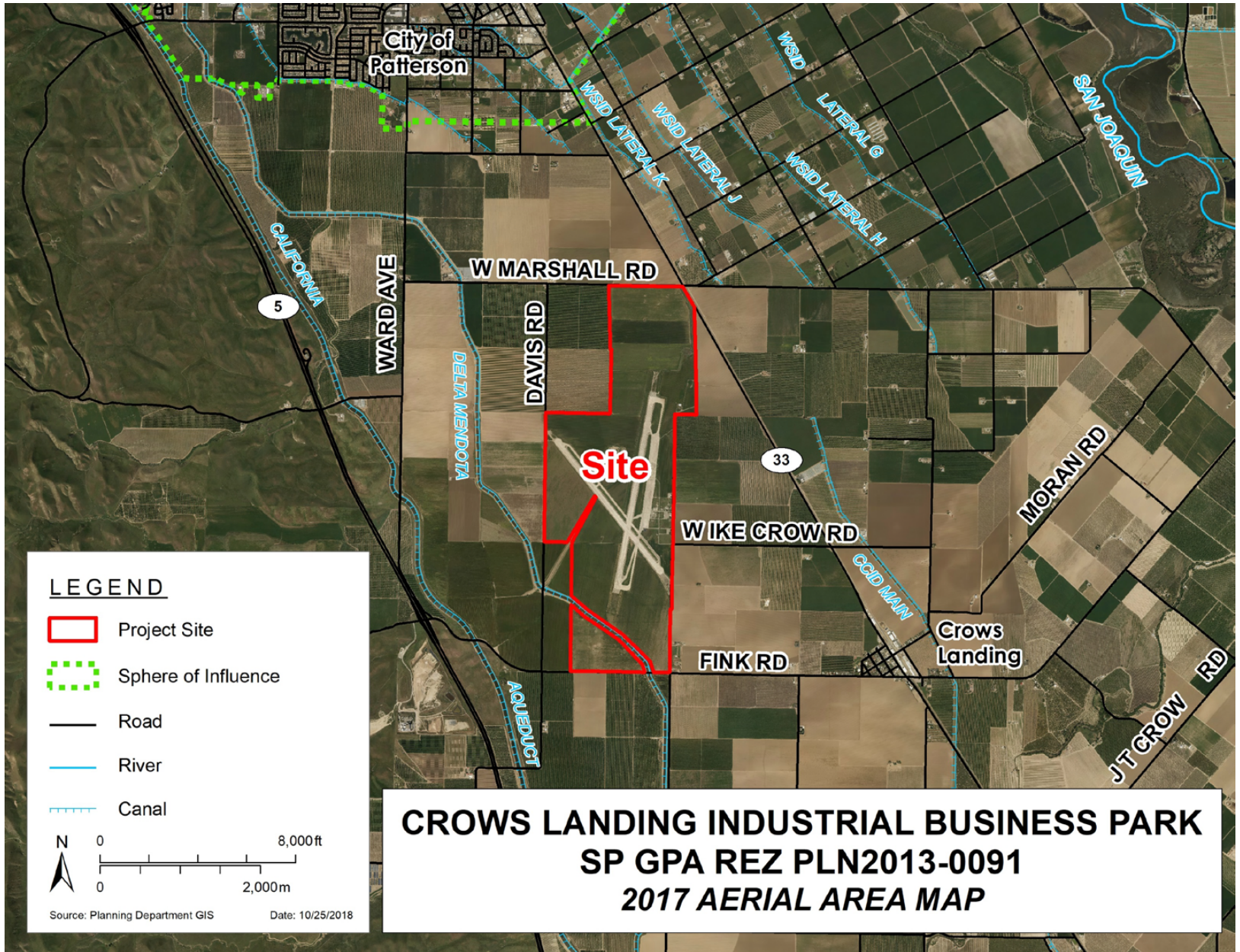
**CROWS LANDING INDUSTRIAL BUSINESS PARK  
SP GPA REZ PLN2013-0091  
AREA MAP**












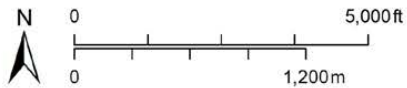


**CROWS LANDING INDUSTRIAL BUSINESS PARK  
SP GPA REZ PLN2013-0091  
2017 AERIAL SITE MAP**

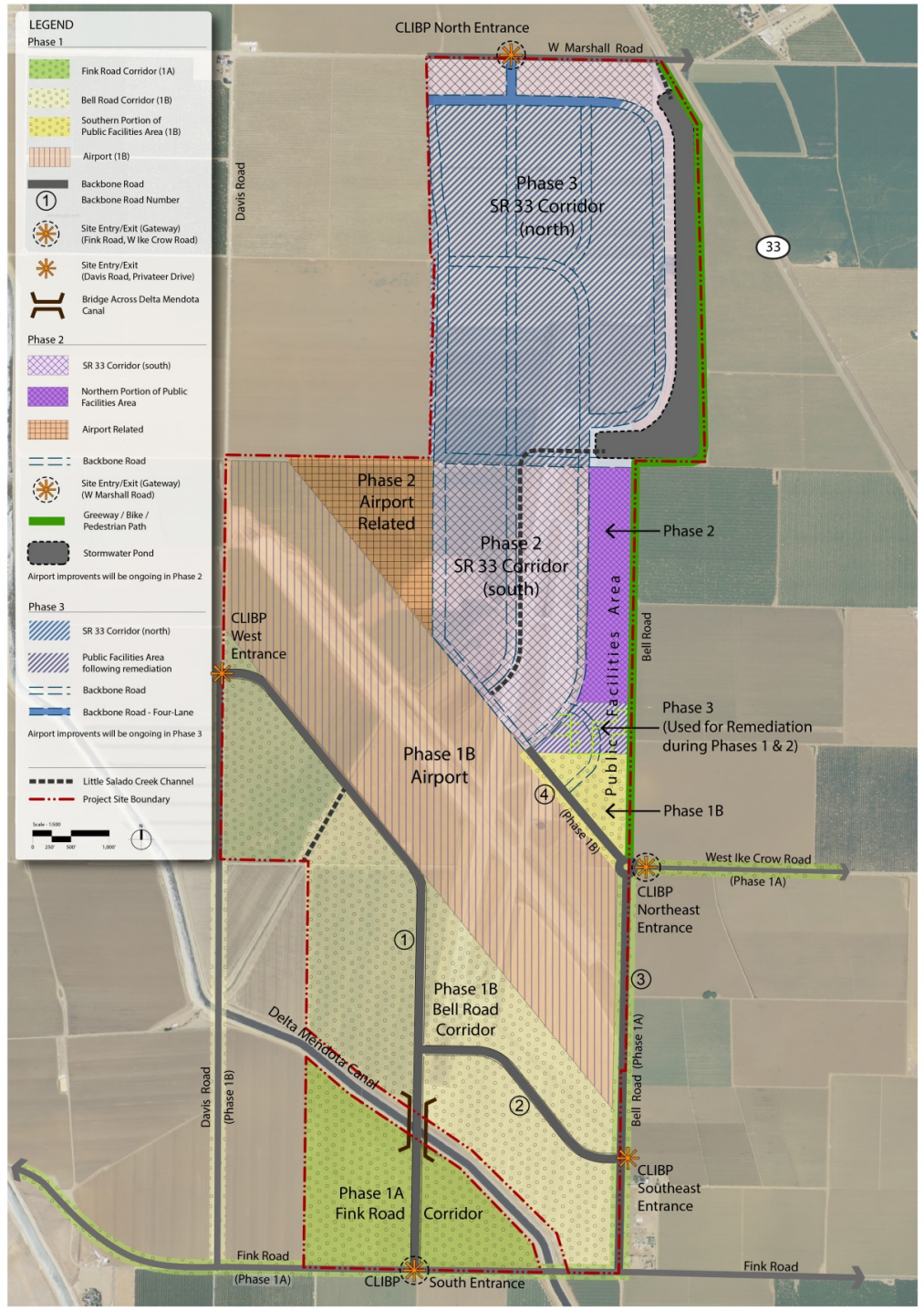


**LEGEND**

-  Project Site
-  Road
-  Canal



Source: Planning Department GIS      Date: 10/25/2018



Source: AECOM 2016  
Figure 2-2: Proposed Plan Phases

Final

# Crows Landing Industrial Business Park Specific Plan

October, 2018



Image: lostamerica.com





---

**1. INTRODUCTION**

1.1 Project Overview ..... 1-1

1.2 Planning Area Location ..... 1-2

1.3 Planning Area History and Description ..... 1-2

    1.3.1 On-Site Jurisdictional Features ..... 1-5

1.4 Plan Objectives ..... 1-7

1.5 Project Vision and Concept ..... 1-8

    1.5.1 Warehouse, Distribution, Logistics, and Light Industrial Uses ..... 1-10

    1.5.2 Business Park Uses ..... 1-10

    1.5.3 Public Facilities Uses ..... 1-10

    1.5.4 General Aviation (GA) Airport and Aviation-Related Uses ..... 1-10

    1.5.5 Multimodal (Bicycle/Pedestrian) Transportation Corridor/ Green Space ..... 1-11

    1.5.6 Agriculture Uses ..... 1-11

    1.5.7 Infrastructure / Utilities ..... 1-11

1.6 Specific Plan Organization ..... 1-12

1.7 Relationship to Other Plans ..... 1-13

    1.7.1 General Plan ..... 1-13

    1.7.2 Airport Land Use Compatibility Plan (ALUCP) ..... 1-13

    1.7.3 Regional Transportation Plan ..... 1-15

    1.7.4 County Code ..... 1-16

1.8 Projects That Must be Consistent with the CLIBP Specific Plan ..... 1-16

1.9 Relationship of the Specific Plan Environmental Document to Subsequent Discretionary Projects ..... 1-16

**2. LAND USE**

2.1 Overview ..... 2-1

2.2 General Land Use Concepts and Development Phasing ..... 2-1

    2.2.1 Zoning, Land Use, and Design and Development Standards ..... 2-1

    2.2.2 Infrastructure ..... 2-1

    2.2.3 Phasing ..... 2-1

    2.2.4 Industrial and Business Park Uses ..... 2-5

    2.2.5 Public Facilities Area Uses ..... 2-5

    2.2.6 General Aviation Use ..... 2-5

    2.2.7 Airport-Related Area Uses ..... 2-6

    2.2.8 Multimodal (Bicycle / Pedestrian) Transportation Corridor/Green Space ..... 2-6



2.2.9	Agriculture Use.....	2-7
2.3	Industrial and Business Park Development Timeframe and Phasing (30 years): .....	2-7
2.4	Land Use Goals .....	2-7
2.5	Land Use Policies .....	2-8
<b>3. BUILT ENVIRONMENT AND DESIGN</b>		
3.1	Overview.....	3-1
3.2	Design Goals.....	3-2
3.3	Public Realm, Plan Area Wide Design .....	3-3
3.3.1	Circulation Framework .....	3-3
3.3.2	Streetscape and Landscape Framework .....	3-8
3.3.3	Open Space Framework .....	3-12
3.3.4	Signage and Wayfinding.....	3-12
3.3.5	Sustainability .....	3-13
3.4	Private Realm Design.....	3-16
3.4.1	Building Siting and Orientation Policies .....	3-16
3.4.2	Building Façade and Articulation Concepts and Policies .....	3-18
3.4.3	Circulation and Parking.....	3-19
3.4.4	Loading and Service Areas .....	3-20
3.4.5	Aviation Considerations.....	3-20
3.4.6	Airport Development.....	3-20
<b>4. INFRASTRUCTURE</b>		
4.1	Overview.....	4-1
4.1.1	Infrastructure Goal .....	4-1
4.1.2	Infrastructure Policies .....	4-1
4.2	Transportation .....	4-2
4.2.1	Transportation Plan.....	4-2
4.2.2	Near Term Improvements Triggered by the CLIBP Project.....	4-5
4.2.3	2035 Regional Growth Plus CLIBP-Triggered Off-Site Improvements .....	4-8
4.2.4	Transportation Demand Management.....	4-11
4.2.5	Transportation Goal.....	4-12
4.2.6	Transportation Policies .....	4-12
4.3	Water Supply and Distribution.....	4-13
4.3.1	Water System Plan .....	4-15

4.3.2	Water Supply and Distribution System .....	4-15
4.3.3	Water System Goals.....	4-32
4.3.4	Water System Policies .....	4-32
4.4	Wastewater Collection and Treatment .....	4-33
4.4.1	Wastewater Collection System Plan.....	4-33
4.4.2	Wastewater Collection System.....	4-34
4.4.3	Wastewater Goal .....	4-36
4.4.4	Wastewater Policies .....	4-36
4.5	Stormwater Management .....	4-40
4.5.1	Stormwater Management Plan.....	4-40
4.5.2	Floodplain Mapping .....	4-43
4.5.3	Stormwater Management Goal.....	4-49
4.5.4	Stormwater Management Policies .....	4-49
4.6	Dry Utilities Plan .....	4-49
4.6.1	Dry Utilities Goal.....	4-50
4.6.2	Dry Utilities Policies .....	4-50
4.7	Solid Waste Collection Plan.....	4-51
4.7.1	Solid Waste Goal.....	4-51
4.7.2	Solid Waste Policies .....	4-51

**5. SPECIFIC PLAN IMPLEMENTATION**

5.1	Overview.....	5-1
5.2	Specific Plan Administration and Procedures .....	5-1
5.2.1	Specific Plan Area Zoning.....	5-1
5.2.2	Design and Development Standards .....	5-1
5.2.3	Public Improvement Plans .....	5-2
5.2.4	Development Review and Entitlement Process .....	5-2
5.2.5	Findings Required for Discretionary Action .....	5-4
5.2.6	Environmental Review.....	5-5
5.2.7	Specific Plan Interpretation.....	5-5
5.3	Infrastructure Costs and Financing .....	5-5
5.3.1	Crows Landing Airport and CLIBP Infrastructure Improvements and Cost.....	5-6
5.3.2	CLIBP Financing Plan .....	5-11

---

## APPENDICES

- Appendix A: Crows Landing Land Use and Employment Summary
- Appendix B: Crows Landing Permitted Land Uses and Design and Development Standards
- Appendix C: Aquatic Resource Delineation Report – Crows Landing Industrial Business Park
- Appendix D: Airport Layout Plan Narrative Report - Crows Landing Airport
- Appendix E: Stanislaus County Standard Plates
- Appendix F: Transportation Infrastructure Plan - Crows Landing Industrial Business Park
- Appendix G: Crows Landing Industrial Business Park Water Supply (Potable & Non-Potable) Infrastructure and Facilities Study
- Appendix H: Crows Landing Industrial Business Park Sanitary Sewer Infrastructure and Facilities Study
- Appendix I: Drainage Study for the Crows Landing Industrial Business Park
- Appendix J: Crows Landing Industrial Business Park Dry Utilities Infrastructure and Facilities Study
- Appendix K: Crows Landing Industrial Business Park Financing Plan
- Appendix L: Crows Landing Industrial Business Park Mitigation Monitoring Reporting Program

## FIGURES

- Figure 1-1: Plan Area Regional Location..... 1-3
- Figure 1-2: Remaining Military Air Facilities ..... 1-4
- Figure 1-3: Potential Waters of the United States, Habitat Types..... 1-6
- Figure 1-4: Airport and Industrial Business Park Areas..... 1-9
- Figure 1-5: Airport Influence Areas, Crows Landing Airport..... 1-14
- Figure 2-1: General Illustrative Concept..... 2-2
- Figure 2-2: Proposed Plan Phases ..... 2-3
- Figure 3-1: Roadway Classification Diagram ..... 3-4
- Figure 3-2: Fink Road (looking east) Near-Term Cross Section for Segment Adjacent to CLIBP... 3-5
- Figure 3-3: W. Marshall Road (looking east) Cross Section for Segment Adjacent to CLIBP ..... 3-5
- Figure 3-4: Davis Road (looking north) Cross Section Adjacent to CLIBP ..... 3-6
- Figure 3-5: Bell Road (looking north) Cross Section Between Fink Road and W. Ike Crow Road.. 3-6
- Figure 3-6: Typical Local Industrial Road, Two-Lane Cross Section ..... 3-7
- Figure 3-7: Typical Local Industrial Road, Four-Lane Cross Section..... 3-7
- Figure 3-8: Proposed Landscape Palette ..... 3-10

Figure 3-9: Examples of Gateway Features .....	3-11
Figure 3-10: Examples of Site Design and Layout.....	3-17
Figure 4-1: Project Vicinity.....	4-3
Figure 4-2: Northwest Newman Master Plan EIR Traffic .....	4-4
Figure 4-3: Off-Site Road Improvements, CLIBP Project Area .....	4-6
Figure 4-4: Alternative A – Crows Landing CSD Water Supply .....	4-18
Figure 4-5: Alternative A CLIBP Raw Water System.....	4-19
Figure 4-6: Alternative A CLIBP Potable Water System.....	4-20
Figure 4-7: Alternative A CLIBP Non-Potable Water System .....	4-21
Figure 4-8: Alternative B – Stand Alone Water Supply for CLIBP.....	4-23
Figure 4-9: Alternative B CLIBP Raw Water System.....	4-24
Figure 4-10: Alternative B CLIBP Potable Water Supply.....	4-25
Figure 4-11: Alternative B CLIBP Non-Potable Water System.....	4-26
Figure 4-12: Alternative C – Extension to CLIBP from the City of Patterson.....	4-28
Figure 4-13: Alternative C CLIBP Raw Water System.....	4-29
Figure 4-14: Alternative C CLIBP Potable Water Supply System .....	4-30
Figure 4-15: Alternative C CLIBP Non-Potable Water System.....	4-31
Figure 4-16: Wastewater System, Phase 1 .....	4-37
Figure 4-17: Wastewater System, Phases 1 and 2.....	4-38
Figure 4-18: Wastewater System, Phases 1, 2, and 3.....	4-39
Figure 4-19: Stormwater Drainage Improvements .....	4-42
Figure 4-20: FEMA Floodplain .....	4-44
Figure 4-21: Existing Floodplain .....	4-46
Figure 4-22: FEMA and Existing Floodplain Comparison .....	4-47
Figure 4-23: Proposed FEMA Floodplain .....	4-48
Figure 5-1: Proposed Plan Phasing Areas .....	5-3

**TABLES**

Table 2-1: Anticipated Development and Phasing By Land Use Category and Phase.....	2-4
Table 3-1: CLIBP Plan Area Roadway Classifications .....	3-3
Table 5-1: Infrastructure Improvement Category Costs by Phase.....	5-8

---

## ACRONYMS AND ABBREVIATIONS

AIA	Airport Influence Area
ALP	Airport Layout Plan
ALUCP	Airport Land Use Compatibility Plan
ATCT	air traffic control tower
Bay Area	Sacramento and the San Francisco Bay Area
BP	booster pump
BRAC	Department of Defense's Base Closure and Realignment
CalRecycle	California Department of Waste Management
CEQA	California Environmental Quality Act
CLIBP	Crows Landing Industrial Business Park
CLOMR	Conditional Letter of Map Revision
CWA	U.S. Clean Water Act
DA	development agreement
DMC	Delta Mendota Canal
EBS	Environmental Baseline Survey
EIR	environmental impact report
FAA	Federal Aviation Administration
FAR	floor area ratio
FBO	fixed-base operator
FEMA	Federal Emergency Management Agency
GA	General Aviation
GVN	Global Valley Networks
I-5	Interstate 5
kV	kilovolt
LEED	Leadership in Energy and Environmental Design
LGs	Land Use Goals
LOMR	Letter of Map Revision
LPs	Land Use Policies
MG	million gallons
MGD	million gallons per day
MMPR	Mitigation Monitoring and Reporting Program
MS4	Municipal Separate Storm Sewer System
MW	megawatts
NAAS	Naval Auxiliary Air Station
NALF	Naval Auxiliary Landing Field

---

NAS	Naval Air Station
NASA	National Aeronautics and Space Administration
NPDES	National Pollutant Discharge Elimination System
OLF	Outlying Land Field
PG&E	Pacific Gas and Electric Company
Plan Area	Crows Landing Industrial Business Park Specific Plan area
ROW	right of way
RTP	Regional Transportation Plan
RWQCB	Regional Water Quality Control Board
SCDPW	Stanislaus County Department of Public Works
SCP	Sustainable Communities Plan
SR	State Route
TID	Turlock Irrigation District
USACE	United States Army Corps of Engineers
WQCF	Water Quality Control Facility

# INTRODUCTION

---

1





## 1.1 PROJECT OVERVIEW

From the commissioning of the Crows Landing Air Facility (Air Facility) as an auxiliary airfield to Naval Air Station Alameda in 1942 until its decommissioning by the National Aeronautics and Space Administration (NASA) as the Crows Landing Flight Facility/NASA Ames Research Center in 1999, the military and civilian work force who lived and worked at the airfield proudly served our nation. The multiple missions and operations that occurred at Crows Landing brought new residents to Stanislaus County and contributed to the economic prosperity of the County, Central Valley, and the State of California and to the security of our nation.

The end of the Cold War reduced military operations at Crows Landing, and the Department of Defense's Base Closure and Realignment Commission (BRAC) identified the airfield for closure during the 1990s. In 1999, the United States Congress passed Public Law 106-82 to convey the former military property to Stanislaus County. Since that time, the County has embraced the opportunity to revitalize its economy through the reuse of the former airfield to benefit County residents and the region as a whole.

For many years, the unemployment rate in Stanislaus County has been higher than the statewide average. Many jobs within the County do not provide wages that are sufficient to sustain a household, and residents seeking sustainable-wage jobs must commute to distant job centers outside of the County, frequently traveling to Sacramento and the San Francisco Bay Area (Bay Area). A 2014 analysis of commuting patterns in the North San Joaquin Valley, which includes San Joaquin, Stanislaus, and Merced Counties, indicated that approximately 23% of Stanislaus County's employed residents commuted outside of the County and 9% commuted to Bay Area communities. The five employment sectors with the highest proportion of residents traveling outside of the County to work were construction; transportation; warehousing and utilities; public administration; wholesale trade; and manufacturing.<sup>1</sup>

For more than a decade, the County has pursued the development of a locally based, regional employment center on the 1,528-acre former military property to improve its jobs-to-housing balance and provide opportunities for sustainable-wage jobs that will not require commutes outside of the County. To that end, the County has designated the former Air Facility as the Crows Landing Industrial Business Park (CLIBP) to support new economic development to bring jobs closer to County residents.

To support economic development in Stanislaus County, the CLIBP Specific Plan promotes the development of land uses that will support job creation in several of the industries that cause its residents to commute. The CLIBP will primarily support light industrial uses, including manufacturing and assembly; transportation and warehousing (logistics); and public administration/facilities, including public administration offices, law enforcement, and public safety services. General office and business park, or other similar uses, are also envisioned. All facilities will be compatible with the presence of a general aviation airport, which will be constructed to reuse one of the former military runways (former Runway 12-30) and provide ongoing aviation access in accordance with Public Law 106-82.

The CLIBP will be zoned as Specific Plan [S-P(2)] in accordance with the Stanislaus County Specific Plan Guidelines. The Specific Plan designation promotes flexibility in the types of permitted land uses, as well as the size and location of those land uses. Build-out of the CLIBP is expected to occur in three phases over an estimated 30-year timeframe.

<sup>1</sup> Business Forecasting Center, September 29, 2014. *An Analysis of Commuting Patterns in the North San Joaquin Valley*. Eberhardt School of Business at the University of the Pacific. Stockton California.

## 1.2 PLANNING AREA LOCATION

The project site or CLIBP Specific Plan area (Plan Area) is located in an unincorporated portion of western Stanislaus County, approximately 1.5 miles east of Interstate Highway 5 (I-5). The 1,528-acre property is bounded by W. Marshall Road to the north, State Route (SR) 33 to the northeast, Bell Road to the east, Fink Road to the south, and Davis Road and agricultural land to the west (see Figure 1-1).

## 1.3 PLANNING AREA HISTORY AND DESCRIPTION

Crows Landing served the U.S. Department of Defense for more than 50 years. From 1942 to 1999, the site was developed and used by the federal government to support the missions of the United States Navy, Coast Guard, and the National Aeronautics and Space Administration (NASA).

The Naval Auxiliary Air Station (NAAS) Crows Landing was commissioned in 1942 as an auxiliary airfield to Naval Air Station (NAS) Alameda. The facility was constructed to train pilots for World War II and expanded to include barracks, hangars and other equipment. In June 1945, the station's complement stood at more than 1,400 officers and enlisted personnel. In 1946, the site became an Outlying Land Field (OLF) to NAS Alameda and later Moffett Field. For many years the Navy maintained a permanent detachment at the field that supplied crash equipment and refueling services for naval aircraft from other stations in the area. The site remained active through the 1980s and supported training activities performed by the Navy and Coast Guard.

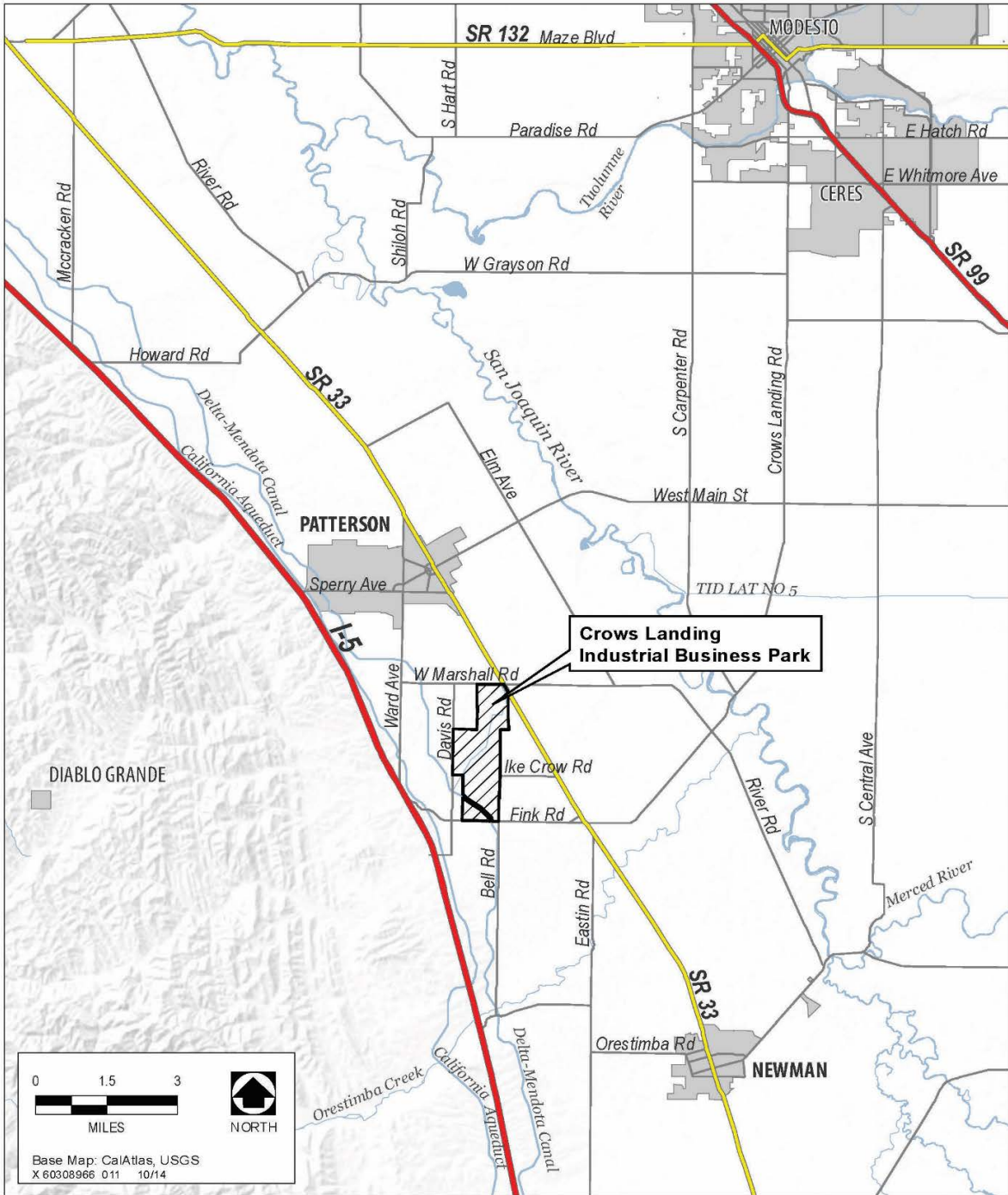
Based on a recommendation of the 1991 BRAC Commission, Congress decided that NAS Moffett Field would no longer be operated by the active-duty Navy. Custodial responsibility for NAS Moffett Field was transferred to the NASA Ames Research Center in July 1994, and NASA assumed custody of the Crows Landing Naval Auxiliary Landing Field (NALF) as it was known at that time. This transfer included all land, buildings, facilities, and infrastructure. Research operations at Crows Landing were terminated after NASA accepted the Crows Landing property.

On October 27, 1999, Congress passed Public Law 106-82, which directed NASA to convey to Stanislaus County all right, title, and interest of the United States in and to the NASA Ames Research Center Crows Landing Facility, formerly known as the Naval Auxiliary Field Crows Landing. To facilitate property conveyance, NASA completed an Environmental Baseline Survey (EBS), which proposed the transfer of the property in two or more phases following the completion of environmental remediation efforts. The Navy has performed soil and groundwater remediation at the former military site in accordance with the terms of the property transfer. Phase I of the property transfer occurred in 2004, when NASA conveyed 1,352 acres of the 1,528-acre property to Stanislaus County. Of the remaining 176 acres, 165 acres are ready for transfer and will be conveyed to the County in 2017.<sup>2</sup> Groundwater remediation infrastructure and facilities are present on the remaining 11-acre area adjacent to the eastern property boundary. The U.S. Navy will continue to operate groundwater remediation activities on the 11-acre area of the CLIBP property until 2024. The Specific Plan addresses all 1,528 acres of the former military site and addresses the ongoing remediation through its proposed phasing plan (see Chapter 2, "Land Use").

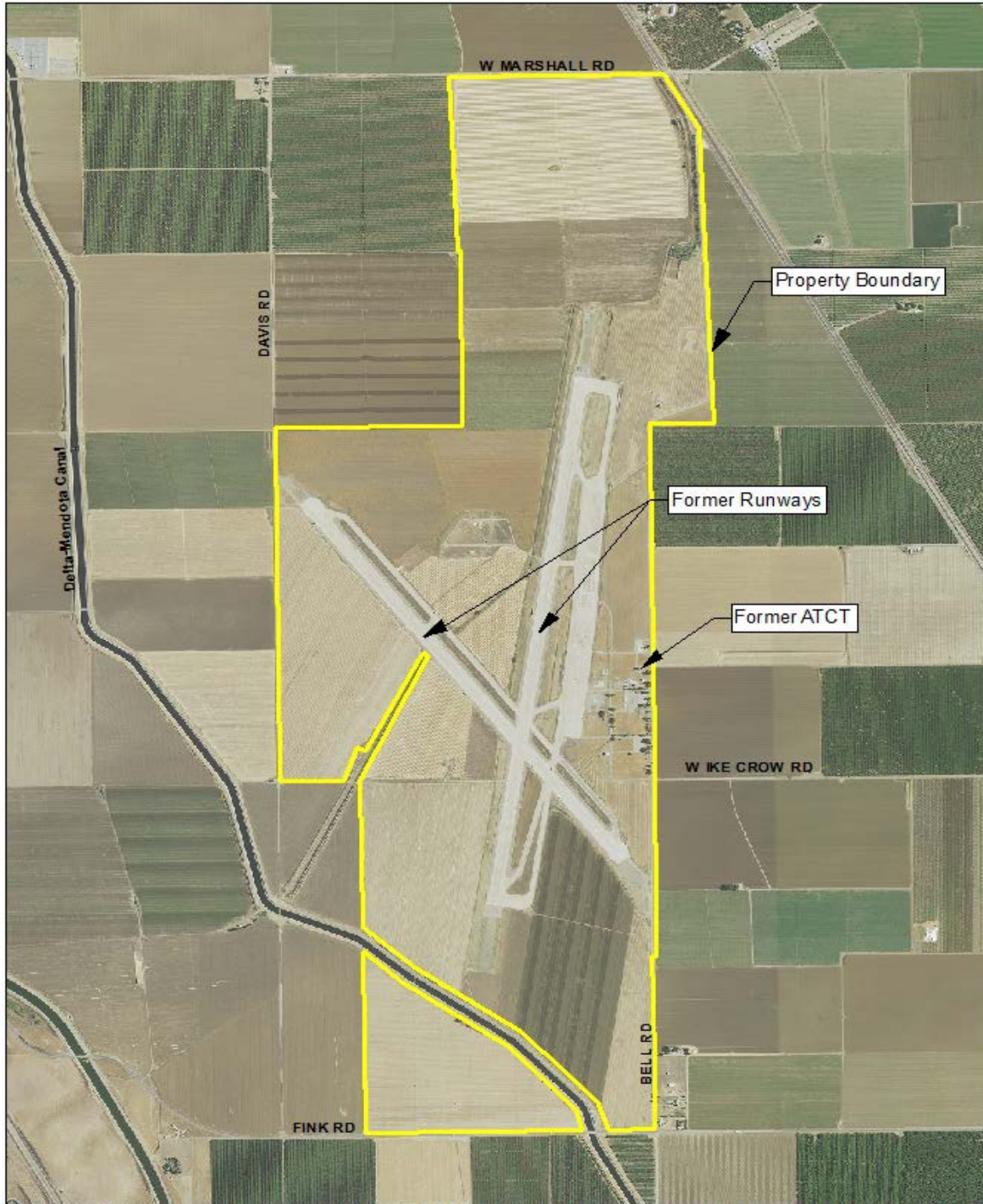
Figure 1-2 illustrates the former military property and the facilities that remained at the time of conveyance. Nearly all structures associated with former military activities were demolished. Remaining facilities include two decommissioned runways, an air traffic control tower (ATCT), and remnant roads. As of 2016,

<sup>2</sup> D.Chuck. 2017. Personal communication (email) to K. Boggs, Stanislaus County, Chief Executive Office, from NASA Ames Research Center dated December 6, 2017.

approximately 1,200 acres of the former Air Facility were being used for agricultural production in accordance with a short-term lease. The property will remain in cultivation until the land is needed for the construction of infrastructure and development in accordance with the Specific Plan.

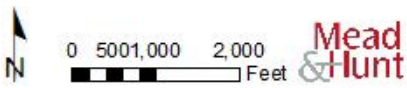


Source: Stanislaus County 2013  
Figure 1-1: Plan Area Regional Location



Source: 2014 Imagery, USDA\_FSA\_APFO Aerial Photography Field Office

Figure 1-2. Planning Area Crow's Landing



Source: Mead & Hunt 2016 (2014 Imagery, USDA\_FSA\_APFO Aerial Photography Field Office)  
Figure 1-2: Remaining Military Air Facilities

### 1.3.1 On-Site Jurisdictional Features

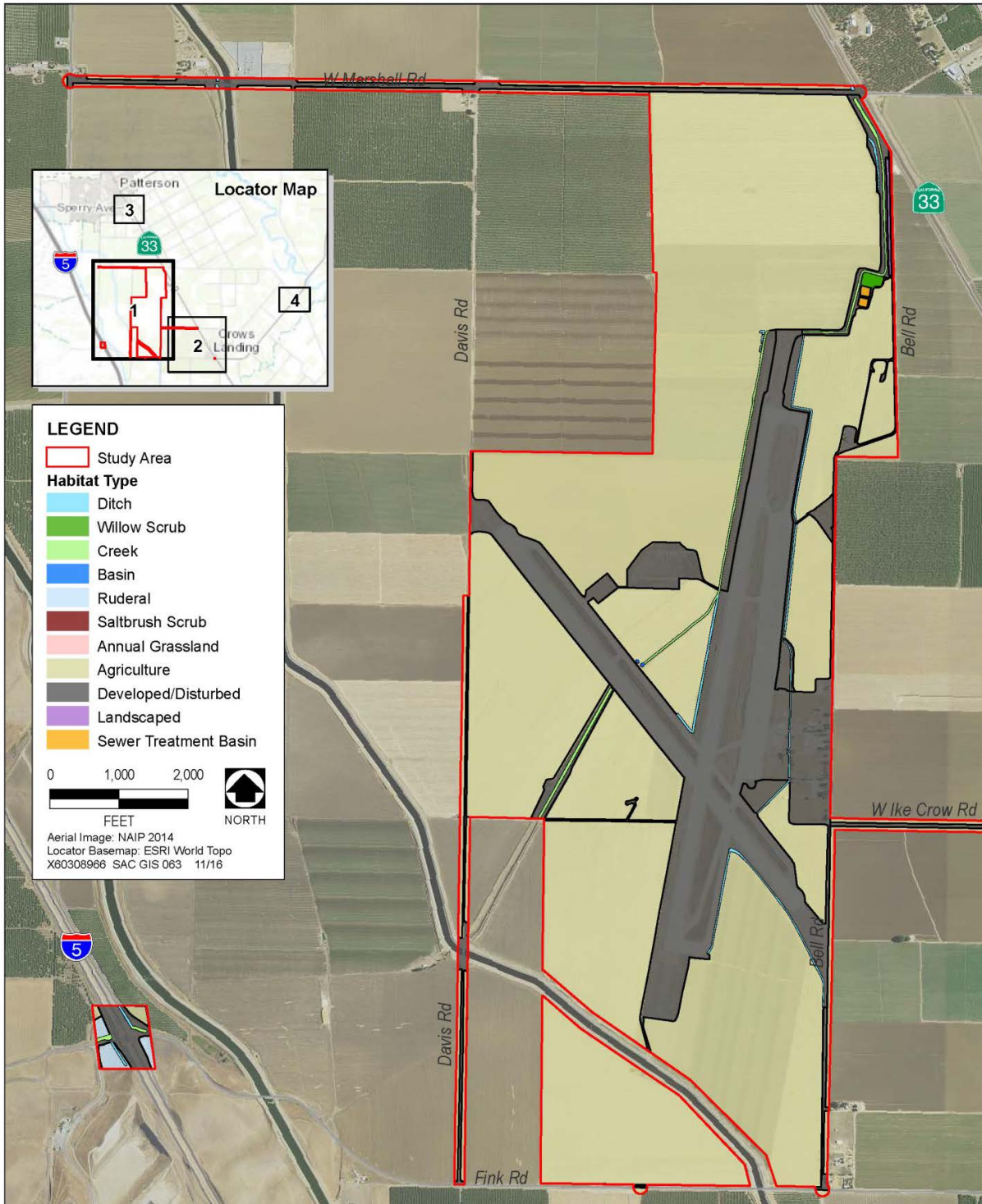
A delineation of waters of the United States study report, *Aquatic Resource Delineation Report – Crows Landing Industrial Business Park* (Appendix C), was prepared to identify jurisdictional features within the Plan Area and in off-site areas that could be affected by infrastructure development required to accommodate CLIBP development. The delineation report identifies and quantifies all potential waters of the United States within the Plan Area, including wetlands. Potential jurisdictional features, by habitat type, have been identified on the project site (see Figure 1-3). An estimated 4.66 acres of potentially jurisdictional features and waters of the United States are present on site, of which approximately 3.6 acres are associated with Little Salado Creek. Two basins were identified adjacent to Salado Creek near the intersection of the former military runways, and an approximately 1-acre wetland is located in the northeastern portion of the site. Habitat types on the project site include primarily agricultural land, formerly landscaped areas, and disturbed or developed areas, with small areas of willow scrub and saltbush scrub.

For project development within 50 feet of water, or projects that result in the discharge of fill or dredge material into any water of the United States (shown in Figure 1-3), the County will be required to obtain a United States Army Corps of Engineers (USACE) Section 404 Individual Permit and Central Regional Water Quality Control Board (RWQCB) Section 401 water quality certification prior to any groundbreaking. Under Section 401 of the U.S. Clean Water Act (CWA), an applicant for a Section 404 permit must obtain a certificate from the appropriate state agency stating that the intended dredging or filling activity is consistent with the state's water quality standards and criteria. In California, the authority to grant water quality certification is delegated by the State Water Resources Control Board to the nine RWQCBs. Wetland habitat will be restored or replaced at an off-site location at an acreage, location, and by methods agreeable to USACE and the Central Valley RWQCB, depending on agency jurisdiction, and as determined during the Section 401 and Section 404 permitting processes.<sup>3</sup>

The Delta Mendota Canal (DMC) is a portion of the Central Valley Project that spans the western San Joaquin Valley to provide essential irrigation water. The DMC is a historic resource pursuant to the National Register of Historic Places (NRHP) that is owned by the United States Bureau of Reclamation (USBR) and operated and maintained by the San Luis & Delta-Mendota Water Authority (Water Authority). In the event that encroachment of the right-of-way is required in order to make repairs to an existing facility, the Water Authority must issue an Access Permit prior to the start of construction.

The DMC traverses the southern portion of the project site. It crosses Fink Road at the project site's southern boundary and forms the boundary between the Fink Road and Bell Road Corridor development areas (see Figure 2-2 in Chapter 2). A new bridge over the canal will be necessary to accommodate internal circulation. Roadway construction and improvements will require coordination with the Water Authority, and subsequent project-related development will be required to respect DMC structures and right-of-way boundaries.

<sup>3</sup> The Federal Aviation Administration recommends that mitigation measures that have the potential to attract wildlife, such as wetlands and open water feature, be constructed 10,000 feet or more from aircraft movement areas (see FAA Advisory Circular 150/5200-33B, "Wildlife Hazard Attractants on and Near Airports").



Source: AECOM 2016  
Figure 1-3: Potential Waters of the United States, Habitat Types

## 1.4 PLAN OBJECTIVES

The reuse of the former Crows Landing Air Facility through the development of the CLIBP is central to Stanislaus County's ongoing strategy to create sustainable-wage jobs for its residents and others living in nearby areas of the Northern San Joaquin Valley. The Specific Plan establishes the framework to implement that strategy. The objectives of the Specific Plan include:

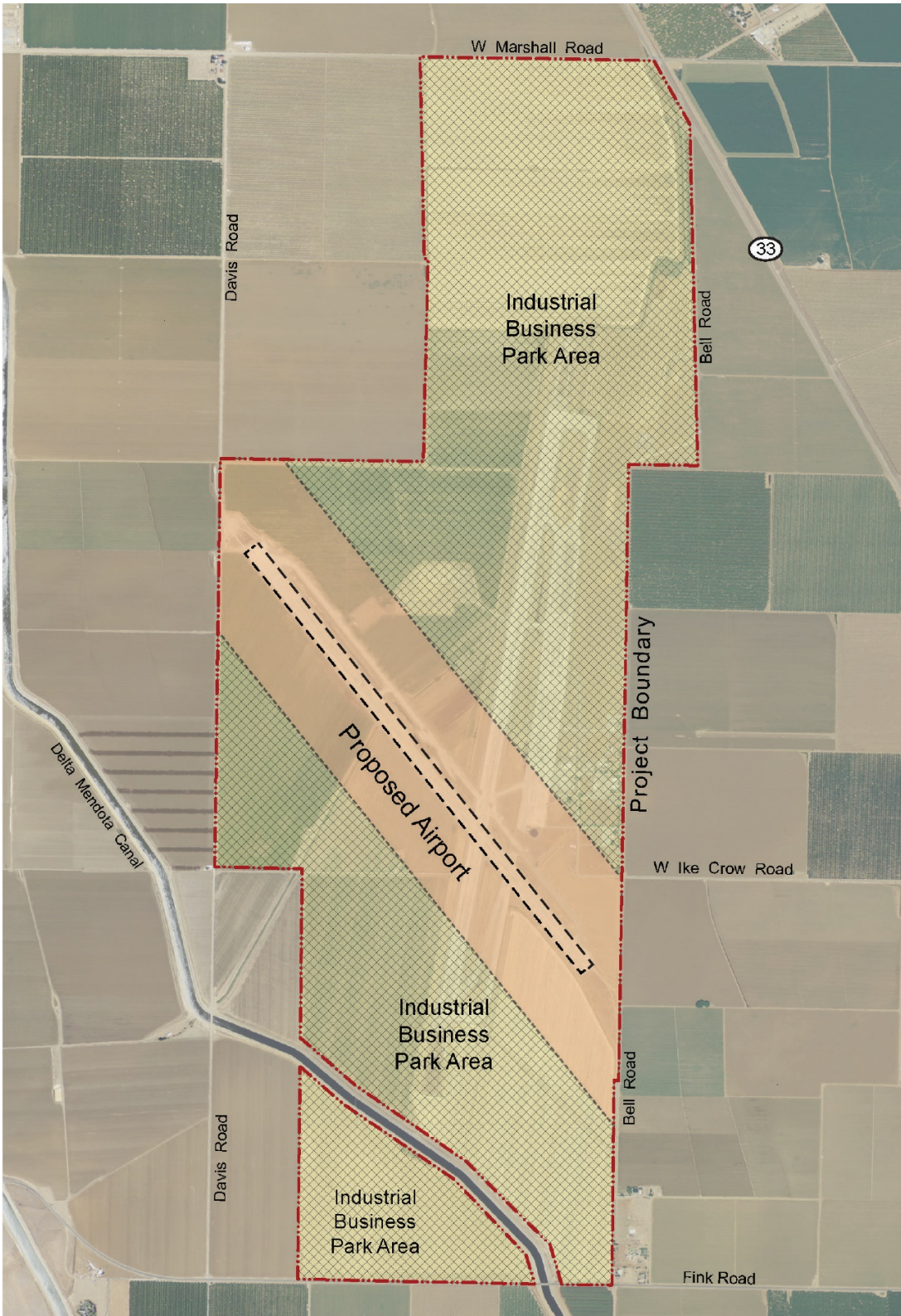
- Objective 1: Reuse the former Crows Landing Air Facility to develop a high quality, attractive industrial business park that makes a positive statement for the area and for Stanislaus County.
- Objective 2: Create a regional employment center on the former Crows Landing Air Facility property, conveyed to Stanislaus County through Public Law 106-82, that will promote development and reduce greenhouse gas emissions by bringing jobs closer to County residents.
  - 2.1 Provide locally based, sustainable-wage employment opportunities in Stanislaus County that will support households and improve the County's jobs-to-housing balance.
  - 2.2 Provide a locally based job center that will reduce commute distances for County and Northern San Joaquin Valley residents and promote air quality improvements through a reduced number of commuter-related vehicle miles traveled and reduced vehicle emissions.
  - 2.3 Provide a locally based job center that will address current market needs and remain flexible to address market changes as they occur.
  - 2.4 Provide local workforce development through opportunities such as on-the-job training, adult classrooms, and non-classroom opportunities.
  - 2.5 Provide a regional employment center that accommodates a broad range of light industrial and business users, including local businesses.
- Objective 3: Create a center for light industrial, manufacturing, logistics, and aviation-related uses that will optimize the site's development potential based on its proximity to Interstate Highway 5 (I-5) and other potential regional, national, and international transportation facilities.
  - 3.1 Accommodate an appropriate mix of light industrial, manufacturing, logistics, business park, public administration, aviation, and aviation-related uses and tenants.
  - 3.2 Provide land use and zoning policies that are flexible in terms of access, size, and configuration of available parcels, vertical development, and compatible with surrounding uses and infrastructure.
  - 3.3 Provide clear and concise development policies and design standards to expedite site development that will be consistent with the Specific Plan.
- Objective 4: Provide for the development of on-site public administration and emergency service facilities to serve the site and Stanislaus County residents.
  - 4.1 Promote the development of government offices, public administration offices, outpatient/medical offices, and other public services to serve County residents.
  - 4.2 Promote the development of emergency services that can benefit from the use and proximity of the general aviation airport including medivac, fire suppression, emergency response, and law enforcement.

- Objective 5: Provide for the phasing of on-site primary or “backbone” infrastructure, sufficient to enable “shovel-ready” on-site development opportunities within a logical progression on the site. Such infrastructure includes transportation/circulation, potable and non-potable water, wastewater, stormwater management, and dry utilities improvements.
- 5.1 Provide for the logical phasing of site development with the availability of infrastructure.
  - 5.2 Provide tenants with good value for the development of new facilities in terms of lease agreements, available infrastructure, etc.
  - 5.3 Support ongoing on-site agricultural activities until such time as on-site construction of infrastructure or development occurs.
- Objective 6: Encourage development that incorporates sustainable site and infrastructure design and implements federal, state, and local energy and water conservation requirements.
- 6.1 Encourage the use of sustainable site and infrastructure designs, including the incorporation of water conservation practices that respond to the ongoing water supply challenges in the Central Valley through use of state, federal, and County mandated water efficient landscape and other conservation practices.
  - 6.2 Provide on-site stormwater drainage and detention facilities that provide for groundwater recharge in a manner that is compatible with nearby aviation use.
- Objective 7: Repurpose former military runway 12-30 to construct a general aviation airport to serve as an amenity for site users and the business and general aviation needs of Stanislaus County and the region.
- Objective 8: Identify potential funding options to secure necessary site improvements.
- Objective 9: Provide for an attractive business park that offers amenities for site workers such as on-site food service, automated banking opportunities, and outdoor pedestrian circulation/paths.
- 9.1 Promote the development of multimodal transit opportunities for site workers that include bus, bicycle, and pedestrian access.
- Objective 10: Honor the unique contributions of the former Crows Landing Air Facility and Stanislaus County to our nation’s history, while looking ahead to improve the lives of the County’s current and future residents.

## 1.5 PROJECT VISION AND CONCEPT

The CLIBP is envisioned as a mixed-use industrial business park that will support a variety of business uses and formats. Mixed-use areas are envisioned throughout the Plan Area to support a variety of light manufacturing and assembly; distribution, warehousing, and logistics; public administration; business park; office; public facilities; and other similar uses. The project also includes the creation of a new public use general aviation airport that would reuse former Runway 12-30, the shorter of the two decommissioned runways that is orientated in a northwest-southeast direction. The airport will serve as an amenity to the CLIBP and the local general aviation community (see Figure 1-4).





Source: AECOM 2016  
Figure 1-4: Proposed Airport and Industrial Business Park Areas

The CLIBP will be a unique industrial business park designed to support flexibly-sized site and building formats and to accommodate a variety of users in a campus environment. Diverse uses from office and incubation spaces for small start-up firms, facilities for mid- to large-size offices and corporate headquarters, to large floor plan warehouse and light manufacturing facilities, including those with one million square feet or more, are desirable in the Central Valley and may be housed within the CLIBP. CLIBP development is intended to bring new jobs to the County and reduce the traffic congestion and resultant vehicle emissions that are produced by residents who must commute outside of the County for similar jobs.

Approximately 14.3 million square feet of development and 14,447 jobs are anticipated at CLIBP build-out.<sup>4</sup> The following sections summarize the proposed land uses and features of the CLIBP, which are described in more detail in subsequent chapters of the Specific Plan. Chapter 2 presents the phasing of development for each land use category and the CLIBP land use goals and policies that support this development, and provides an illustrative site plan concept. Appendix B provides a more detailed list of the permitted land uses and design and development standards.

### **1.5.1 Warehouse, Distribution, Logistics, and Light Industrial Uses**

A large portion of the Plan Area is envisioned to support the demand for large distribution sites because of the CLIBP's location near I-5, especially logistics and warehouse uses that desire easy and convenient transportation access, as well as light industrial uses. Examples include large sorting and distribution facilities, wholesale and warehouse facilities, agriculture/dry food processing and packaging, machine shops, assembly of pre-manufactured parts, and transportation facilities.

### **1.5.2 Business Park Uses**

The business park uses envisioned within the Plan Area include call centers, research and development, and business support services. Business park uses may be developed in association with proposed logistics and light industrial uses, as standalone facilities, or in building clusters centered on common open space and employee amenities.

### **1.5.3 Public Facilities Uses**

The main entrance or gateway to the CLIBP is envisioned at the intersection of Bell and W. Ike Crow Roads on the east side of the Plan Area. A small area northwest of this intersection is designated for development of public facilities and other uses that can benefit Stanislaus County residents. This area is also near the airport's northeastern boundary and entrance to provide opportunities for agencies that may require quick access to the airport or for aviation-related services, such as fire suppression, law enforcement, or medical evacuation. Other uses envisioned for the Public Facilities Area include local and district government offices, professional offices, and outpatient/medical offices.

### **1.5.4 General Aviation (GA) Airport and Aviation-Related Uses**

The 370-acre Crows Landing Airport will be developed to reuse infrastructure associated with former military runway 12-30 to the greatest extent possible. A helipad/heliport may also be constructed south of the runway. The mix of land uses proposed in the Specific Plan would be compatible with aviation and the

<sup>4</sup> Refer to the detailed Land Use and Employment Summary table, provided in Appendix A of the CLIBP Specific Plan, for additional information on estimated land use categories, extent of development associated with each phase, and employment projection at CLIBP build-out.

policies set forth in the Stanislaus County Airport Land Use Compatibility Plan (ALUCP). The CLIBP Specific Plan, an Airport Layout Plan (ALP) for the GA airport, and an amendment to the County's ALUCP to incorporate airport-specific policies for proposed land uses located in the vicinity of the Crows Landing Airport were developed concurrently to promote the development of compatible land uses throughout the CLIBP site. Potential airport users include business travelers, recreational aviators, flight schools, delivery services, and emergency services. The airport and aviation-related land uses are discussed further in Chapter 2 of the Specific Plan.

### **1.5.5 Multimodal (Bicycle/Pedestrian) Transportation Corridor/Green Space**

A multimodal (bicycle/pedestrian) transportation path is proposed along Bell Road, between Fink and W. Ike Crow Roads, and extending north to W. Marshall Road/SR 33. The multimodal path will provide bicycle and pedestrian access between the north and south end of the industrial business park. The portion of Bell Road north of W. Ike Crow Road will be abandoned as a public roadway to accommodate the construction of a bicycle/pedestrian transportation corridor and linear stormwater management pond, but the road will provide existing levels of access to private properties east of Bell Road. The approximately 13-acre transportation corridor north of W. Ike Crow Road is envisioned to be a landscaped bicycle/pedestrian path with a 1- to 2-acre green space area for CLIBP employees and visitors. The multimodal transportation corridor and stormwater pond will provide a physical and visual barrier and buffer between the industrial business park and adjacent agricultural land.

### **1.5.6 Agriculture Uses**

Since 2000, approximately 1,200 acres of the property have been leased for private agricultural use. Agricultural activities will be allowed to continue on-site until such time that the land is needed for imminent construction of infrastructure or development in accordance with the Specific Plan.

### **1.5.7 Infrastructure / Utilities**

The County will undertake on-site primary or backbone infrastructure improvements to render the CLIBP shovel-ready for development and to make the site more attractive to potential developers and tenants. Infrastructure planning studies have been prepared to assess the feasibility of available infrastructure and new demand for infrastructure and utility services associated with the proposed CLIBP land uses. As discussed in detail in Chapter 4, "Infrastructure," required infrastructure, including both site-specific and regional infrastructure demands, will include:

- on-site backbone road and off-site roadway improvements – roads that provide primary internal circulation and connections to the surrounding off-site street network;
- reliable water supply (potable and non-potable) – the County will explore three alternatives and select a preferred alternative prior to initiation of Phase 1:
  - Option 1: extending the Crows Landing Community Services District (CSD) service area to include the CLIBP to enable the development of a shared water system under the CSD's existing drinking water supply permit;
  - Option 2: Obtaining a new water supply permit to enable the County to develop a standalone water supply for the CLIBP, or

- Option 3: extending the City of Patterson’s water service area to include the CLIBP under its existing drinking water supply permit;
- connections for wastewater treatment – the County will explore the feasibility of a new sewer collection system that connects to the City of Patterson Water Quality Control Facility (WQCF) to treat project wastewater, with limited interim use of septic systems during initial site development. If the County determines this option is not feasible, an on-site conveyance and treatment option would be developed;
- stormwater drainage – the widening of Little Salado Creek and culverts, construction of a stormwater pond, and other measures as needed are identified to manage stormwater runoff; and;
- dry utilities – utility service would be provided by Pacific Gas & Electric Company (PG&E) (natural gas), Turlock Irrigation District (electricity), and AT&T, Global Valley Networks (GVN), and Comcast (communications). Dry utility infrastructure would be located in joint trenches along the western or southern sides of on-site roadways.

## 1.6 SPECIFIC PLAN ORGANIZATION

The CLIBP Specific Plan addresses the following:

- **Introduction**, which provides an overview of the Specific Plan purpose, objectives, use, content, relationship to other local and regional plans, and other general information.
- **Land Uses**, which describes the categories of permitted land uses and the character of development within the Plan Area, project phasing, and the goals and policies that inform the Specific Plan content.
- **Built Environment and Design**, which includes site-specific objectives and policies for the baseline design features that will define the built environment for the CLIBP.
- **Infrastructure**, which addresses the infrastructure required for development (i.e., facilities for potable and non-potable water, wastewater, stormwater management, transportation/circulation, and dry utilities).
- **Specific Plan Implementation**, which addresses the administration of the Specific Plan and construction costs associated with the infrastructure, airport, and multimodal transportation corridor for CLIBP development.
- **Appendix A, Crows Landing Land Use and Employment Summary**, using typical industry standards and metrics for floor area ratio (FAR), provides the assumptions and calculations for the developable area for the various land uses and associated employment projections for the Plan Area.
- **Appendix B, Land Use and Design and Development Standards**, identifies specific permitted land uses and the standards to guide the design and development of the CLIBP through both mandatory regulations and discretionary design guidance.
- **Appendix C, Aquatic Resource Delineation Report – Crows Landing Industrial Business Park**

- **Appendix D, Airport Layout Plan Narrative Report – Crows Landing Airport**
- **Appendix E, Stanislaus County Standard Plates**
- **Appendix F, Transportation Infrastructure Plan – Crows Landing Industrial Business Park**
- **Appendix G, Crows Landing Industrial Business Park Water Supply (Potable & Non-Potable) Infrastructure and Facilities Study**
- **Appendix H, Crows Landing Industrial Business Park Sanitary Sewer Infrastructure and Facilities Study**
- **Appendix I, Drainage Study for the Crows Landing Industrial Business Park**
- **Appendix J, Crows Landing Industrial Business Park Dry Utilities Infrastructure and Facilities Study**
- **Appendix K, Crows Landing Industrial Business Park Financing Plan**
- **Appendix L, Crows Landing Industrial Business Park Mitigation Monitoring Reporting Program**

## **1.7 RELATIONSHIP TO OTHER PLANS**

### **1.7.1 General Plan**

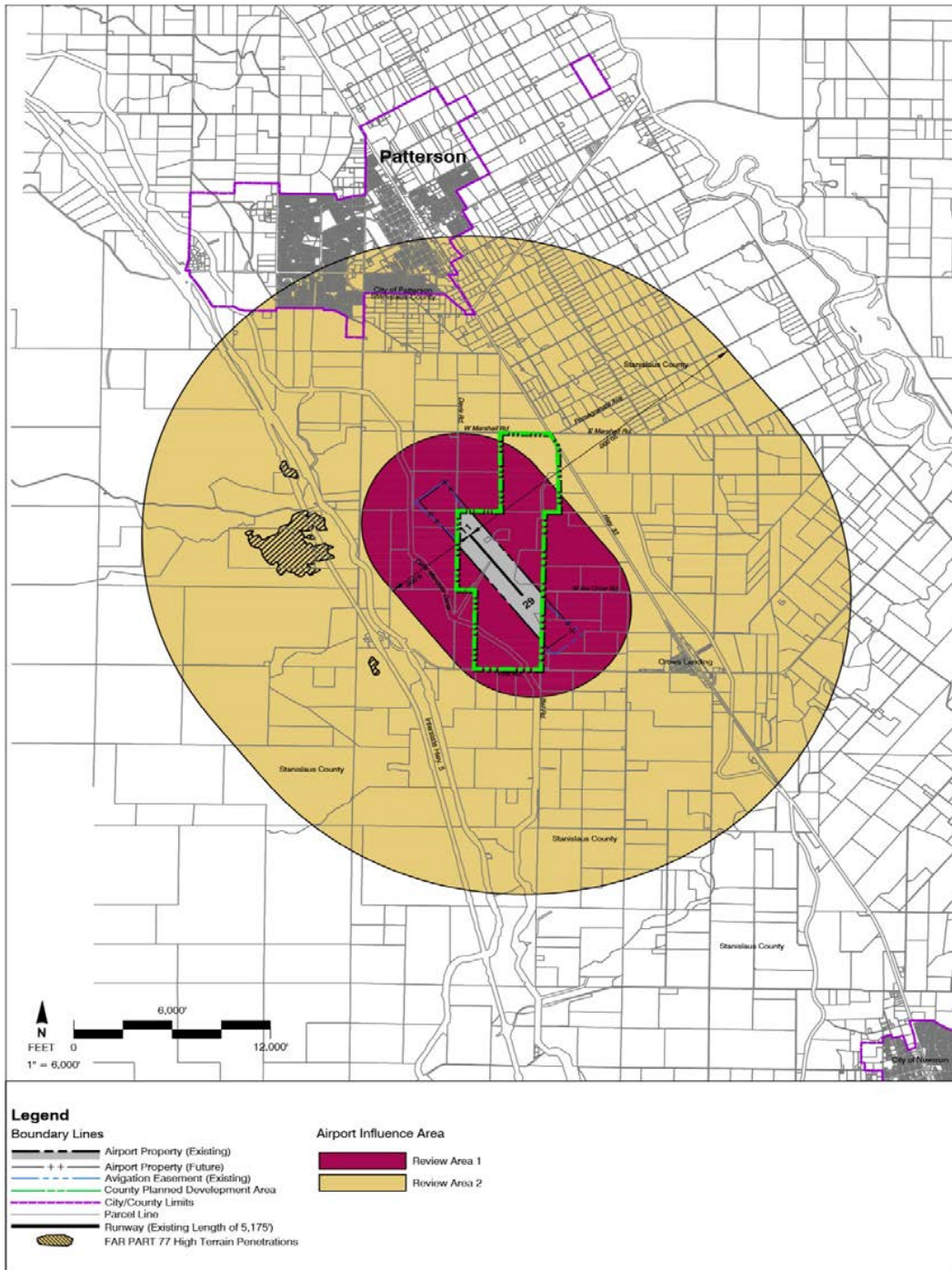
The Stanislaus County General Plan’s Land Use Diagram designates the CLIBP property as Agricultural, and the County’s Zoning Code identifies the CLIBP property as A-2, General Agriculture District. However, Policy 18 of the General Plan directs the County to “promote diversification and growth of the local economy” and Implementation Measure 9 of the General Plan, associated with this policy, states “encourage reuse of the Air Facility as a regional jobs center.” The Specific Plan further supports Policy 18 and implements Measure 9 of the General Plan by describing development specifically for the CLIBP Plan Area including policies, zoning, permitted uses, and design and development standards. Figure 1-1 identifies the location of the Plan Area within the County.

### **1.7.2 Airport Land Use Compatibility Plan (ALUCP)**

The Stanislaus County ALUCP includes procedural policies and airport-specific policies for identifying the consistency of proposed land uses located in the designated airport influence areas for the County’s three public-use airports: Modesto City-County Airport, Oakdale Municipal Airport, and the former Crows Landing Naval Air Facility. All development within the CLIBP must be consistent with the Countywide ALUCP. Airport-specific policies in the ALUCP address the following:

- **Aircraft noise exposure.** The ALUCP identifies locations that will be subject to aircraft noise exposure and seeks to avoid the creation of noise-sensitive land uses in areas that are exposed to significant levels of aircraft noise.
- **Safety.** Safety compatibility criteria seek to minimize the risks associated with an off-airport incident or emergency landing. The ALUCP provides policies pertaining to the land uses that are considered compatible with aviation and the densities and intensities of such uses.

- **Airspace.** The Federal Aviation Administration (FAA) identifies federally protected airspace that must remain free of obstructions. Effects or factors such as tall structures, construction equipment, glare, emissions, and wildlife can affect or pose risks to air operations. The ALUCP identifies navigable airspace and policies for development beneath protected airspace.
- **Overflight.** Areas that are not affected by noise exposure or are outside of safety zones may be subject to aircraft overflight. Although these areas are not subject to policy restrictions, landowners and tenants must be notified that they live in an Airport Influence Area (AIA) as defined by the ALUCP. Figure 1-5 presents the AIA associated with the Crows Landing Airport.



Source: Stanislaus County ALUCP  
 Figure 1-5: Airport Influence Area, Crows Landing Airport

The proposed project includes an amendment to the Countywide ALUCP that will include new policies for the proposed Crows Landing Airport. The new policies will replace the former ALUCP policies associated with the former military airfield. Figure 1-5 presents the Airport Influence Area associated with the proposed Crows Landing Airport. The AIA represents the geographic area to which the new ALUCP policies would apply following adoption.

### 1.7.3 Regional Transportation Plan

The adopted 2014 Stanislaus County Regional Transportation Plan/Sustainable Communities Strategy (RTP/SCS) focuses on maintaining the region's vitality and character by creating a more sustainable transportation system and land use development pattern. The RTP/SCS identifies seven goals and corresponding objectives that can be used to measure its success in linking transportation and land use planning strategies, as summarized below:

- **Goal 1. Mobility & Accessibility.** Improve the ability of people and goods to move between desired locations; and provide a variety of transportation choices.
- **Goal 2. Social Equity.** Promote and provide equitable opportunities to access transportation services for all populations and ensure that all populations share in the benefits of transportation improvements and provide a range of transportation and housing choices.
- **Goal 3. Economic and Community Vitality.** Foster job creation and business attraction, retention, and expansion by improving quality of life through new and revitalized communities.
- **Goal 4. Sustainable Development Pattern.** Provide a mix of land uses and compact development patterns; and direct development toward existing infrastructure, which will preserve agricultural land, open space, and natural resources.
- **Goal 5. Environmental Quality.** Consider the environmental impacts when making transportation investments and minimize direct and indirect impacts on clean air and the environment.
- **Goal 6. Health & Safety.** Operate and maintain the transportation system to ensure public safety and security and improve the health of residents by improving air quality and providing more transportation options.
- **Goal 7. System Preservation.** Maintain the transportation system in a state of good repair and protect the region's transportation investments by maximizing the use of existing facilities.

The CLIBP reflects the goals of the RTP/SCS by providing for the development of a regional employment center near existing transportation corridors, such as I-5 and SR 33, and providing multimodal transportation opportunities on site (Goal 1); fostering job creation (Goal 3); directing development toward and reusing/maximizing the use of existing facilities, while preserving agricultural land, open space, and natural resources (Goals 4 and 7); and producing a local job center to reduce commute times and distances, and vehicle emissions associated with commuter traffic to improve air quality.

The RTP/SCS acknowledges the County's proposal to redevelop the former Air Facility to create a job center and GA airport consistent with regional planning goals, which will help the project qualify for future transportation grant funding.



#### **1.7.4 County Code**

Development within the CLIBP must adhere to the standards of the Specific Plan and the Stanislaus County Code. Where the standards of the Specific Plan conflict with regulations in the County Code, the standards of the Specific Plan shall prevail. Where the Specific Plan is silent, the standards of the County Code shall apply. Chapter 21.38 in Title 21, “Zoning,” of the County Code permits the creation of a specific plan district to govern and apply to a specific zone of land with unique characteristics that may require standards of its own, in addition to complying with other existing County standards. The S-P zoning provides a mechanism to ensure the orderly and cohesive site development of special or unique development areas, while ensuring compliance with and implementation of the General Plan. S-P zoning also provides for development consistent with site characteristics, creation of optimum quantity and use of open space, encouragement of good design, and promotion of compatible land uses.

#### **1.8 PROJECTS THAT MUST BE CONSISTENT WITH THE CLIBP SPECIFIC PLAN**

All individual development projects, ministerial or discretionary, proposed within the CLIBP Plan Area are subject to the requirements of the Specific Plan.

#### **1.9 RELATIONSHIP OF THE SPECIFIC PLAN ENVIRONMENTAL DOCUMENT TO SUBSEQUENT DISCRETIONARY PROJECTS**

Proposed projects that are prepared in accordance with the Specific Plan and the certified environmental impact report (EIR), and ALUCP, may qualify for ministerial review. A proposed project that is determined to deviate from or be inconsistent with the intent and standards of the Specific Plan and its referenced documents, or with the occurrence of the events set forth in CEQA Guidelines, Section 15183, may require a Specific Plan amendment or additional environmental analysis.

Proposed airport development projects that are prepared in accordance with the ALP Narrative Report – Crows Landing Airport (Appendix D), Specific Plan, and certified EIR may qualify for ministerial review. A proposed project that is not shown on the ALP or inconsistent with the intent and standards of the ALP, the Specific Plan and its referenced documents, or with the events set forth in the CEQA Guidelines may require an ALP update, ALUCP update, Specific Plan amendment, or additional environmental analysis.

LAND USE

2



## 2.1 OVERVIEW

Of the 1,528-acre property conveyed by NASA to the County, approximately 1,274 acres will be developed for a mix of aviation-compatible industrial and business park uses, general aviation, aviation-related land uses, public facilities, and a multimodal (bicycle/pedestrian) transportation corridor. The remaining acreage will be associated with necessary infrastructure, including roads and right-of-ways for stormwater drainage, water supply, wastewater facilities, and dry utilities.

This chapter describes the Crows Landing Industrial Business Park (CLIBP) Specific Plan area (Plan Area) development program (i.e., phasing) including the types of land use categories and their envisioned characteristics, land use goals, and policies. The land use goals, policies, categories, and development program described in this chapter correspond to and implement the development objectives presented in Chapter 1, “Introduction.” The development standards associated with each land use category are addressed in the CLIBP Design and Development Standards, which are provided in Appendix B.

## 2.2 GENERAL LAND USE CONCEPTS AND DEVELOPMENT PHASING

The CLIBP is envisioned primarily as a mixed-use industrial business park designed to support a variety of light industrial, logistics, warehouse, distribution, office, and aviation-related land uses. Only the general aviation airport, which will be constructed to reuse a former military runway (Runway 12-30), is fixed by size and location. Figure 2-1 presents a general concept of the land use and development character envisioned within the Plan Area at build-out and suggests the potential distribution of the broad land use categories.

### 2.2.1 Zoning, Land Use, and Design and Development Standards

The entire CLIBP Plan Area shall be zoned S-P(2) and developed to include the land uses presented in Appendix B and summarized in this chapter. Appendix B provides a more detailed list of land uses permitted within each broader land use category and identifies the design and development standards proposed for each category.

### 2.2.2 Infrastructure

Infrastructure includes internal roadways and infrastructure rights-of-way including water supply, wastewater facilities, stormwater drainage, and dry utilities. Infrastructure encompasses approximately 254 acres (17%) of the CLIBP Plan Area.

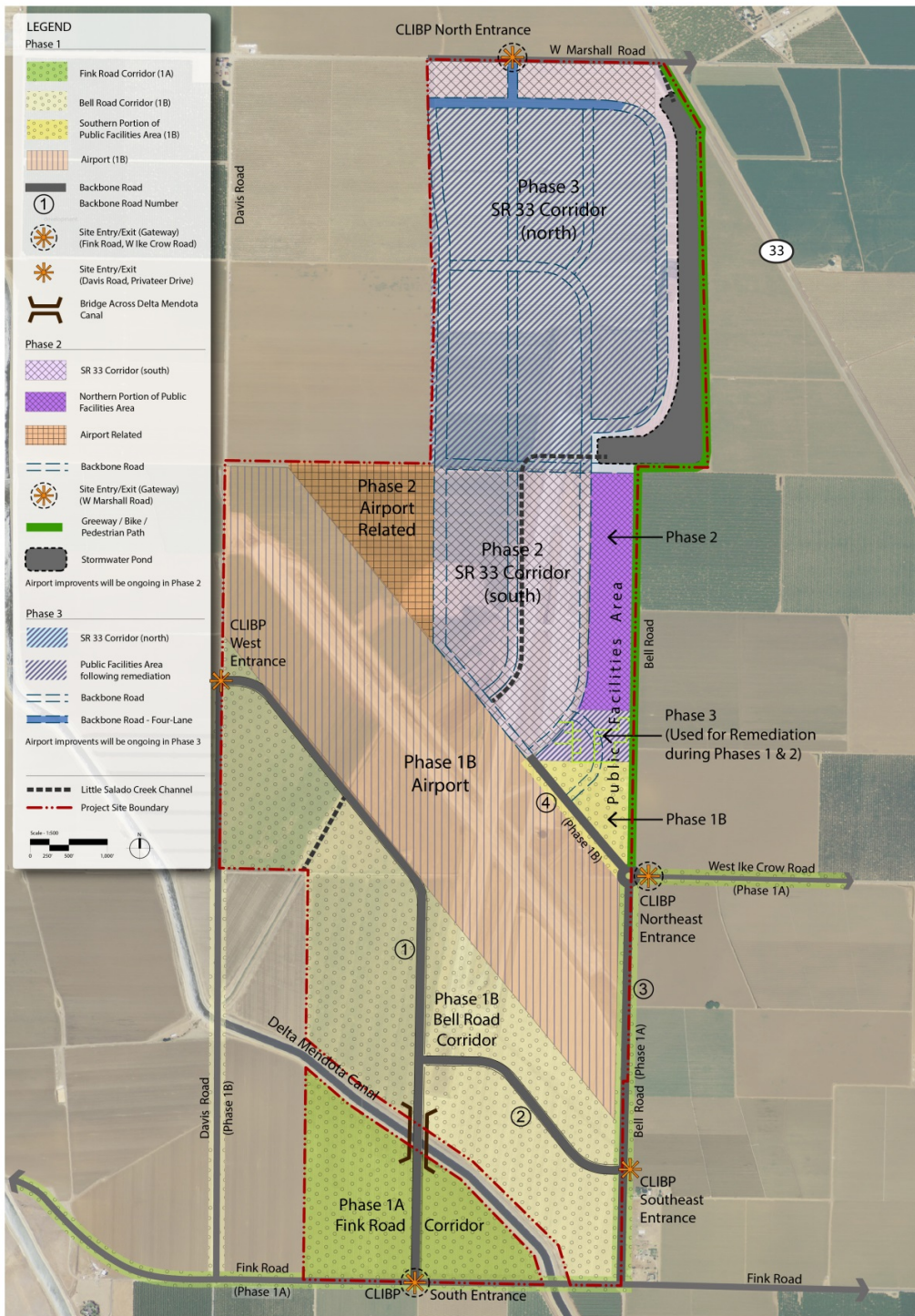
### 2.2.3 Phasing

As shown in Figure 2-2, CLIBP Plan Area infrastructure and land use development would occur over three ten-year phases. Phase 1A development would occur in the Fink Road Corridor and extend to the Bell Road Corridor, airport, and southern Public Facilities Area in Phase 1B:

- Phase 1: 2017 to 2026 (includes Phases 1A and 1B)
- Phase 2: 2027 to 2036
- Phase 3: 2037 to 2046



Source: AECOM 2016  
*Figure 2-1: General Illustrative Concept*



Source: AECOM 2016  
 Figure 2-2: Proposed Plan Phases

Table 2-1 and the following sections summarize the likely land use categories and extent of development associated with each phase over the 30-year build-out period. Appendix B provides a more detailed list of land uses permitted within each land use category. The proposed phasing of Plan Area development will allow the County to estimate the carrying costs of project-related impacts such as traffic, and utility infrastructure and services. As shown in Table 2-1, approximately 1,274 acres have been identified for development. The remaining acreage (approximately 254 acres) will accommodate necessary roadway and utility infrastructure. Actual development, including the mix, distribution, and acreages of specific land uses, may vary from the assumptions in Table 2-1 based on available infrastructure and market needs. Such variations may be permitted as long as they are consistent with the intent of the Specific Plan and do not create new or greater environmental impacts than those identified in the Specific Plan’s Environmental Impact Report (EIR). Additional environmental studies may be required if the mix of proposed land uses would yield a greater density/intensity of use than those considered in the Specific Plan or have the potential to create environmental impacts that exceed those identified in the Specific Plan’s EIR.

<b>Table 2-1: Anticipated Development and Phasing by Land Use Category and Phase (acres)</b>						
Land Use	Description	Phase 1		Phase 2	Phase 3	Total All Phases
		1A	1B			
<b>Logistics/Distribution</b>	Packaging, warehouse, and distribution, etc.	52	138	57	102	<b>349</b>
<b>Light Industrial</b>	Light industrial manufacturing, machine shops, etc.	41	110	71	128	<b>350</b>
<b>Business Park</b>	Research and development, business support services, etc.	10	28	14	26	<b>78</b>
<b>Public Facilities</b>	Government offices, professional offices, emergency services, etc.	0	15	35	18	<b>68</b>
<b>General Aviation</b>	Airport runways, aprons, hangars, etc.	0	370	0	0	<b>370</b>
<b>Aviation Related</b>	Parcel distribution, aviation classroom training, etc.	0	0	46	0	<b>46</b>
<b>Multimodal Transportation Corridor/Green Space</b>	Bicycle and pedestrian trail, greenway, monument to military use.	0	0	13	0	<b>13</b>
<b>All Uses by Phase</b>		<b>103</b>	<b>661</b>	<b>236</b>	<b>274</b>	<b>1,274</b>
<b>Infrastructure</b>	Internal roadways, water and wastewater systems, stormwater drainage, etc.					<b>254</b>
<b>Plan Area Total</b>						<b>1,528</b>

#### **2.2.4 Industrial and Business Park Uses**

The majority of the Plan Area is envisioned to consist of a broad range of industrial and business park uses such as logistics, warehouse, distribution, light industrial, and offices. Phasing of the industrial business park uses is described in Section 2.3.

##### ***Logistics, Warehouse, and Distribution***

The demand for distribution sites in the local area that are greater than one million square feet exceeds the available supply in the region. Although logistics, warehouse, and distribution uses are allowed throughout the Plan Area, with the exception of the airport and Public Facilities Area (in some cases), it is anticipated that these uses will be developed primarily in the southern portion of the Plan Area (Fink and Bell Road Corridors) based on their proximity to Interstate Highway 5 (I-5) via Fink Road and the presence of similar nearby uses.

##### ***Light Industrial***

In addition to logistics, warehouse, and distribution uses, the Specific Plan envisions light industrial uses such as assembly, furniture and consumer electronics manufacturing and machine shops.

##### ***Business Park***

Business park uses are envisioned within the Plan Area and would include uses such as call centers, research and development, and business support services. Business park uses may be developed in association with proposed logistics, warehouse, distribution, and light industrial uses, or as standalone facilities.

#### **2.2.5 Public Facilities Area Uses**

The main entrance or gateway to the CLIBP is envisioned at the intersection of Bell and W. Ike Crow Roads, where a roundabout, transit stop(s), and directional signs will be constructed. An area northwest of this intersection has been designated for the development of public facilities and other uses or services to benefit County residents. The Public Facilities Area's location near the airport entrance will allow those agencies that provide immediate response services with quick access to the airport. Such agencies may provide fire suppression, law enforcement, and other emergency services. Other specific uses envisioned for the Public Facilities Area include local and district government offices, professional offices, including outpatient/medical offices, and accessory retail uses, such as a small coffee or sandwich shop for CLIBP users and workers.

The County envisions public facility development will begin in the southern portion of the Public Facilities Area during Phase 1B, as this is the former Air Facility's administration area and contains remnant roadways and other infrastructure that may be refurbished to support initial Plan Area development. Additional infrastructure, including a portion of a proposed interior road, Backbone Road #4, will be constructed during Phase 1B (see Figure 2-2). As shown, the northern portion of the Public Facilities Area will be developed during Phase 2. The remaining central portion of the Public Facilities Area will be developed in Phase 3, following the completion of groundwater remediation.

#### **2.2.6 General Aviation Use**

The approximately 370-acre Crows Landing Airport will reuse pavement and infrastructure associated with former military runway 12-30 to the greatest extent practicable. The mix of land uses associated with CLIBP



development are compatible with the airport following the application of appropriate guidance and design and development standards set forth in the Specific Plan, the Stanislaus County Airport Land Use Compatibility Plan (ALUCP), and applicable state and federal regulations and guidance. Existing and proposed roads will serve as barriers between adjacent land uses and the airport, which will be enclosed by a security fence. Potential users include business travelers, recreational aviators, flight schools, and delivery services, as well as emergency services. A helipad will be constructed in the southeastern portion of the airport.

All improvements required by the California Department of Transportation, Division of Aeronautics, to obtain a permit to operate a GA airport will be carried out during Phase 1B. Subsequent airport improvements will be constructed based on user demand during later development phases.

### **2.2.7 Airport-Related Area Uses**

Approximately 46 acres adjacent to the northwestern airport boundary are designated for aviation-related uses. Although light industrial, logistics, distribution, warehouse, and business park uses allowed throughout the Plan Area will also be permitted in this area, the area will be preserved during initial development, as feasible, for prospective tenants who require close access to the airport to support their operations, such as airport-related cargo (parcel) distribution and medical evacuation services. As shown in Figure 2-2, this area is anticipated for development during Phase 2.

### **2.2.8 Multimodal (Bicycle/Pedestrian) Transportation Corridor/Green Space**

A multimodal (bicycle/pedestrian) transportation path is proposed along Bell Road, between Fink and W. Ike Crow Roads, and extending north to W. Marshall Road/SR 33. The portion of Bell Road north of W. Ike Crow Road will be abandoned as a public roadway to accommodate construction of a bicycle/pedestrian transportation corridor and linear stormwater management pond, but the road will provide existing levels of access to private properties east of Bell Road.

A paved Class 3 bicycle/pedestrian path will be constructed outside of the airport fence and along the west side of Bell Road. The path will be separated from the roadway by a wide drainage swale, and it will connect to a landscaped Class 3 bicycle/pedestrian path and greenway north of W. Ike Crow Road. The path will run along the Bell Road alignment, east of the stormwater management pond, to W. Marshall Road/SR 33. The multimodal transportation path and stormwater management pond will provide a physical and visual barrier and buffer between the industrial business park and adjacent agricultural lands.

The approximately 13-acre transportation corridor north of W. Ike Crow Road is envisioned to be a landscaped bicycle/pedestrian path with a 1- to 2- acre green space area for CLIBP user and employee use. Existing site features and attractive aviation-compatible landscaping will be installed to encourage recreational use by CLIBP users and workers during breaks. The green space will include the former air traffic control tower (ATCT) structure. Although the tower will no longer be used for aviation purposes, the structure will serve as a focal point and monument to commemorate the site's five decades of military use. The proposed multimodal transportation corridor and green space are anticipated to be developed during Phase 2.

### 2.2.9 Agriculture Use

The County has leased portions of the CLIBP site to a local agriculturalist as an interim site use. Agricultural activities will be allowed to continue on-site until such time that the land is needed for the imminent construction of infrastructure and development, in accordance with the Specific Plan.

## 2.3 INDUSTRIAL AND BUSINESS PARK DEVELOPMENT TIMEFRAME AND PHASING (30 YEARS):

- **Phase 1, Fink and Bell Road Corridors:** Development is anticipated to begin adjacent to Fink Road (Fink Road Corridor) during Phase 1A (opening through year 5) and extend into the Bell Road Corridor, which includes the area between the Delta Mendota Canal (DMC) and the airport, during Phase 1B (years 6 through 10). Based on their proximity to I-5, the Fink Road and Bell Road Corridor areas are envisioned to support primarily, but not exclusively, logistics, distribution, and warehouse uses. Infrastructure, including Backbone Roads 1 through 3, and improvements to Davis Road to accommodate the Fink Road and Bell Road Corridors and the southern portion of the Public Facilities Area will be constructed (see Figure 2-2). Specific infrastructure requirements for each phase of CLIBP development are discussed in Chapter 4, “Infrastructure.”
- **Phase 2, State Route (SR) 33 Corridor (South) and Airport-Related Area:** More logistics, business park, and light industrial uses are likely to extend northward into the southern portion of the SR 33 Corridor during Phase 2. Development of SR 33 Corridor (south) and development of the Airport-related Area will benefit Phase 1B airport development, continued Public Facilities Area development, and initial logistics, warehouse, and distribution development adjacent to Fink and Bell roads. Roadway improvements associated with the westward extension of W. Ike Crow Road and gateway improvements along Bell Road during construction of Phase 1 and Phase 2 infrastructure will support development in these areas.
- **Phase 3, State Route (SR) 33 Corridor (North):** Logistics, business park, and light industrial uses are anticipated to extend further into the northern portion of the SR 33 Corridor during Phase 3. Improvements to the W. Marshall Road entrance and infrastructure improvements identified for the northern portion of the Plan Area during Phase 2 and 3 would support ongoing development. The remaining central portion of the Public Facilities Area will be developed in Phase 3 following the completion of groundwater remediation.

## 2.4 LAND USE GOALS

The following Land Use Goals (LGs) correspond directly to the project objectives identified in Chapter 1 for the CLIBP Plan Area.

- LG 1: Identify and plan for logistics, warehouse, distribution, light industrial, business park, aviation, and aviation-related land uses, and public facilities, on the former Crows Landing Air Facility property to provide sustainable-wage employment opportunities for the residents of Stanislaus County and the Northern San Joaquin Valley.
- 1.1 Identify and plan for land uses that will support the long-term economic growth of the County.

- 1.2 Identify and plan for land uses that can reuse the former Air Facility infrastructure to the greatest extent practicable.
  - 1.3 Identify and plan for land uses that will support the development of public facilities and public administration (e.g., fire suppression, law enforcement, government offices) that will benefit County residents.
  - 1.4 Identify land uses and policies that foster flexibility in terms of leasehold (lot) size, tenant development, lease agreements, and the demand for industrial and business park property.
- LG 2: Allocate land uses and develop transportation infrastructure in a manner that encourages transit opportunities and other multimodal access and circulation (e.g., bicycle and pedestrian use).
- 2.1 Establish an on-site transit network that provides convenient access for workers commuting to and from the CLIBP and enhances the County’s transit network.
  - 2.2 Establish internal circulation infrastructure that supports and incorporates bicycle and pedestrian access, where practical.
- LG 3: Identify the need for infrastructure to support a variety of logistics, warehouse, distribution, light industrial, business park, aviation, and aviation-related land uses, and public facilities, for the estimated 30-year timeframe associated with the build-out of the Plan Area.
- 3.1 Provide primary or “backbone” infrastructure to ready the Plan Area for development in accordance with the proposed land uses and phasing plans presented in this document (see Chapter 4, “Infrastructure,” for infrastructure and infrastructure phasing information).
  - 3.2 Promote ongoing coordination with nearby communities, utilities, and service providers, prior to and during development.
- LG 4: Support on-site agricultural operations until the land is needed for imminent infrastructure or proposed development.

## 2.5 LAND USE POLICIES

The following Land Use Policies apply to the entire CLIBP Plan Area.

- LP 1: Designate the 1,528-acre former Crows Landing Air Facility property, which was conveyed to the County through Public Law 106-82, as the Crows Landing Industrial Business Park (CLIBP).
- LP 2: Designate areas for aviation-compatible light industrial, logistics, warehouse, distribution, and business park uses based on their proximity to on-site and off-site roadway infrastructure.
- 2.1 Designate an approximately 103-acre area of the Plan Area as the Fink Road Corridor, which shall occupy the area north of Fink Road and south of the Delta Mendota Canal.
    - 2.1.1 The Fink Road Corridor area is envisioned to support primarily logistics, warehouse, and distribution uses due to its proximity to I-5, but may accommodate other uses.
    - 2.1.2 Fink Road shall provide direct access to this area.

- 
- 2.2 Designate an approximately 276-acre area that occupies the Plan Area south of the Crows Landing Airport and north of the Delta Mendota Canal as the Bell Road Corridor.
    - 2.2.1 The Bell Road Corridor area is envisioned to support primarily logistics, warehouse, and distribution uses due to its proximity to I-5, but may accommodate other uses.
    - 2.2.2 Fink Road, Bell Road, a portion of Davis Road south of the airport, and new interior roads shall provide access to the Bell Road Corridor area.
  - 2.3 Designate a portion of the Plan Area as the State Route (SR) 33 Corridor, which shall occupy the area north of the airport, south of W. Marshall Road, and west of the Public Facilities Area and stormwater management pond.
    - 2.3.1 The SR 33 Corridor area is envisioned to support primarily, but not exclusively, light industrial, logistics, and business park uses.
    - 2.3.2 The SR 33 Corridor area shall be accessed primarily from W. Marshall Road and W. Ike Crow Road
  - LP 3: Designate the area adjacent to Bell Road and north of W. Ike Crow Road as a Public Facilities Area, supporting the development of public facilities and public administration uses.
    - 3.1 The Public Facilities Area shall accommodate emergency and other services that may require close proximity and easy access to airport facilities.
    - 3.2 The Public Facilities Area shall include the Plan Area's main gateway entrance and transit stop(s).
    - 3.3 An approximately 1- to 2- acre area of the Public Facilities Area adjacent to the air traffic control tower (ATCT) shall be developed as a green space and monument to honor those who served our nation during the site's five decades of military use and multiple missions.
  - LP 4: Designate the 370-acre area adjacent to former military runway 12-30 as a public-use, general aviation airport to be owned and operated by Stanislaus County.
    - 4.1 Airport development shall occur in a logical manner and in accordance with an adopted Airport Layout Plan (ALP) and an operating permit from the California Department of Transportation, Division of Aeronautics.
    - 4.2 Proposed land uses and infrastructure located within the boundaries of the Plan Area shall be consistent with the Stanislaus County Airport Land Use Compatibility Plan (ALUCP), as amended, and incorporated into the Specific Plan by reference. Any use that would pose risk to aircraft operation shall be prohibited.
    - 4.3 The Crows Landing Airport shall serve as an amenity to CLIBP users and aviators in nearby Central Valley and Bay Area Communities.
    - 4.4 Through-the-fence operations shall not be permitted.
  - LP 5: Preserve an approximately 46-acre area, adjacent to the northwestern boundary of the Crows Landing Airport and east of Davis Road, for aviation-related land uses, as feasible, during initial development.

- 
- 5.1 This area shall be preserved for tenants who require close access to the Crows Landing Airport as an integral part of their operation, but light industrial, logistics, warehouse, distribution, and business park land uses are permitted, as well as emergency services.
- LP 6: Designate an approximately 13-acre multimodal (bicycle/pedestrian) transportation corridor/greenway along the northeastern Plan Area boundary north of the intersection of W. Ike Crow and Bell Roads.
- 6.1 The multimodal transportation corridor shall serve as a transportation facility and support interior circulation. It shall also serve as a buffer between the CLIBP and adjacent land uses.
- LP 7: Promote development in three ten-year phases that are linked to the specific infrastructure improvements defined in Chapter 3, "Built Environment and Design," Chapter 4, "Infrastructure," and Chapter 5, "Specific Plan Implementation."
- LP 8: Provide visual separation and buffers from adjacent land uses through the use of setbacks, berms, and appropriate landscaping and provide designs that face inward to the CLIBP.
- LP 9: Residential uses, including temporary uses, such as worker dormitories and transient uses, shall be prohibited throughout the Plan Area.
- LP 10: Agricultural activity shall continue in the Plan Area until such time that the land is needed for imminent construction of infrastructure and development.
- LP 11: All development shall comply with design and development standards established in the Specific Plan and other plans incorporated by reference.





### 3.1 OVERVIEW

Chapter 3 addresses the built environment or physical site features that are anticipated within the Crows Landing Industrial Business Park (CLIBP) Specific Plan area (Plan Area). It will introduce the design and development framework for the CLIBP and establish the goals and policies for future development within the Plan Area. Design and development standards, which are intended to support the high-quality design and development of the CLIBP and apply to all development within the Plan Area, are provided in Appendix B.

This chapter is organized into two main sections:

1. **Public Realm:** Plan Area design features that address site planning and design elements for the overall CLIBP; and
2. **Private Realm:** Building siting and architectural design elements that apply to individual development leaseholds (lots) or future tenants and projects within the CLIBP.

This section is further organized by design topics.

#### *Public Realm, Plan Area Wide Design*

- Circulation Framework
- Streetscape and Landscape Framework
- Open Space Framework
- Signage and Wayfinding
- Sustainability

#### *Private Realm Design*

- Building Siting and Orientation Policies
- Building Facade and Articulation Concepts and Policies
- Circulation and Parking
- Loading and Service Areas
- Aviation Considerations
- Airport Development



### 3.2 DESIGN GOALS

The following design goals establish the overarching design themes and principles for the Plan Area and express the desired outcome of project implementation.

- D 1: Create a high-quality industrial business park that reuses the former Air Facility, to the extent practicable, and stimulates investment in Stanislaus County through attractive design, landscaping, building, and other design features.
- D 2: Provide an industrial business park that respects the rural nature of the surrounding areas by minimizing potential conflicts with adjacent land uses, to the extent feasible.
  - 2.1 Focus development internally within the Plan Area.
  - 2.2 Incorporate design features that provide visual separation and transition from adjacent land uses through use of vegetated berms and other landscaping, screening, building setbacks, and building articulation.
- D 3: Promote Plan Area design and development that draws inspiration from and takes advantage of local conditions.
  - 3.1 Incorporate water-sensitive principles and features into the landscape, building, and infrastructure design, including stormwater management, where feasible, that recognizes the importance of water conservation in the Plan Area.
- D 4: Integrate the history of the former Air Facility into the Plan Area through design features and landscape themes that commemorate the site's former military use, including the use of monuments, signs, and structures.
- D 5: Enhance the safety of aviators, workers, and those living near the Plan Area through implementation of design and development standards that prevent or reduce hazards to aircraft operations and comply with the Stanislaus County Airport Land Use Compatibility Plan (ALUCP).
- D 6: Provide flexibility for site development by providing variably sized leaseholds (lots), building types, and site configurations to accommodate a diversity of business types.
- D 7: Promote campus-style layouts within the Plan Area whenever possible. For example, allow suppliers to cluster around manufacturers to increase efficiency for businesses.
- D 8: Consider current and future business needs during planning for individual sites/leaseholder development.
- D 9: Design the circulation system to promote efficient and safe movement patterns. Specific goals include:
  - 9.1 Reduce conflicts between vehicular and pedestrian traffic,
  - 9.2 Combine driveways and access areas (when possible),
  - 9.3 Provide adequate maneuvering and stacking areas as guided by the standards in this section, and
  - 9.4 Support safe access for emergency vehicles.
- D 10: Support walkable connections between facilities by providing common areas for social interaction and worker recreation, as well as safe and convenient pedestrian circulation between buildings, parking facilities, and common spaces.

### 3.3 PUBLIC REALM, PLAN AREA WIDE DESIGN

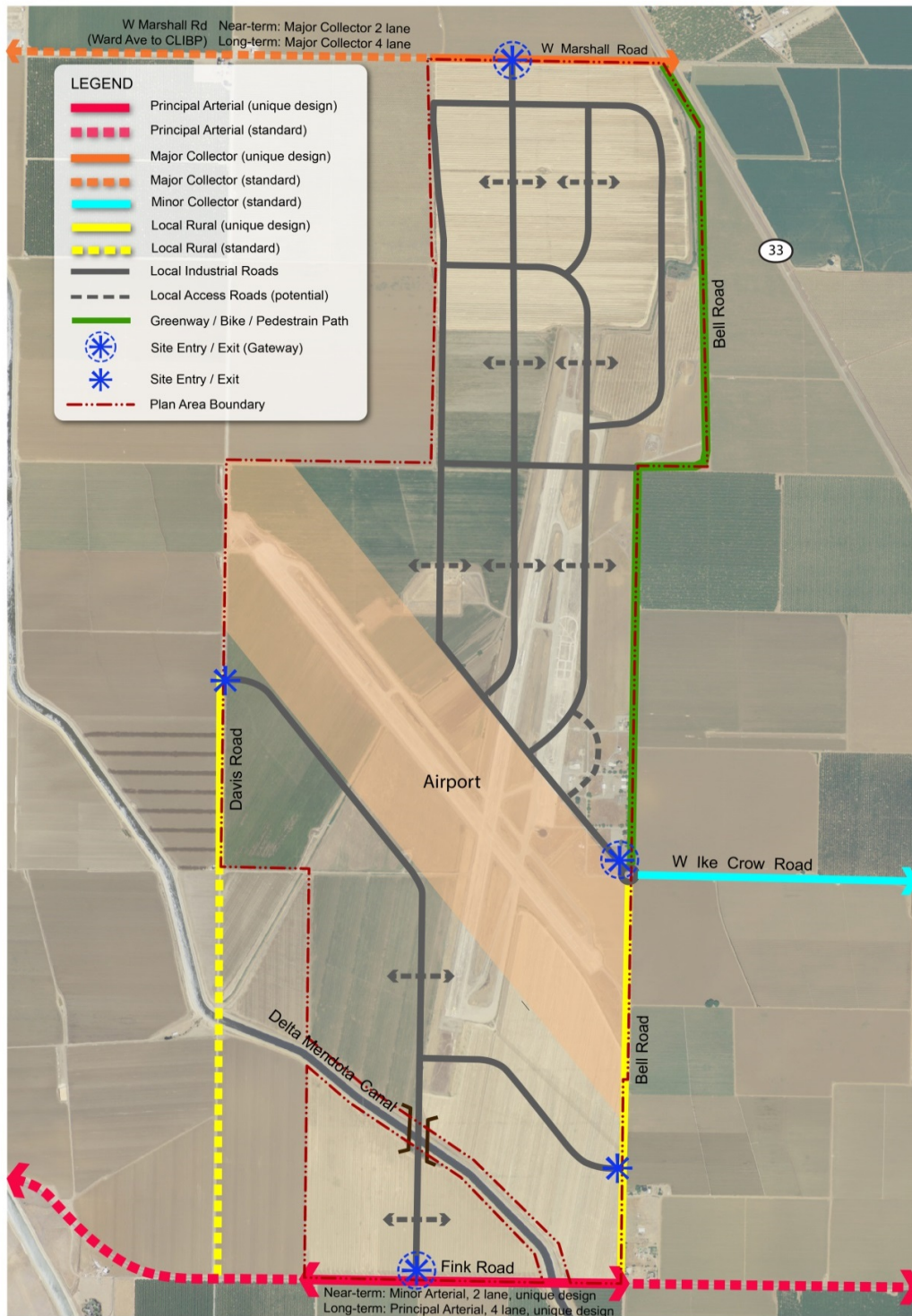
#### 3.3.1 Circulation Framework

The Plan Area roadway network will be designed to accommodate vehicular and pedestrian travel, as well as bicycle travel at strategic locations. The design and sizing of streetscape features will blend in with the rural quality of the project area by supporting a comfortable and safe environment for all users and by integrating low-impact development strategies to manage stormwater run-off on site.

The Plan Area will include a hierarchy of roadways including principal arterial, major collector, minor collector, local rural, local industrial, and local access roads as summarized in Table 3-1 and illustrated in Figure 3-1. In some cases segments of the same road will be designed according to Stanislaus County Public Works Department roadway standards (standard plates), while others will be designed to address site-specific needs. Figures 3-2 through 3-7 illustrate the site-specific roadway designs identified in Table 3-1.

<b>Roadway Classification</b>	<b>Purpose</b>	<b>Roadway Design</b>
Principal Arterial	Road providing primary access to and from the CLIBP (south) <ul style="list-style-type: none"> <li>• Fink Road (adjacent to CLIBP)</li> <li>• Fink Road (east and west of CLIBP)</li> </ul>	<ul style="list-style-type: none"> <li>• See Figure 3-2</li> <li>• County Standard Plate 3-A16*</li> </ul>
Major Collector	Road providing primary access to and from the CLIBP (north) <ul style="list-style-type: none"> <li>• W. Marshall Road (adjacent to CLIBP)</li> <li>• W. Marshall Road (CLIBP to Ward Avenue)</li> </ul>	<ul style="list-style-type: none"> <li>• See Figure 3-3</li> <li>• County Standard Plate 3-A13*</li> </ul>
Minor Collector	<ul style="list-style-type: none"> <li>• W. Ike Crow Road</li> </ul>	<ul style="list-style-type: none"> <li>• County Standard Plate 3-A12*</li> </ul>
Local Rural	<ul style="list-style-type: none"> <li>• Davis Road (adjacent to CLIBP)</li> <li>• Davis Road (CLIBP to Fink Road)</li> <li>• Bell Road (with multimodal path)</li> </ul>	<ul style="list-style-type: none"> <li>• See Figure 3-4</li> <li>• County Standard Plate 3-A11*</li> <li>• See Figure 3-5</li> </ul>
Local Industrial	Local roads providing internal circulation and access within the CLIBP and also carrying the backbone infrastructure for site development, including water, wastewater, and other utilities.	<ul style="list-style-type: none"> <li>• See Figures 3-6 and 3-7</li> </ul>
Local Access	Private or semi-public roads internal to specific developments that provide shared access and driveways to multiple buildings/developments.	Not applicable.

\* County standard plates are those adopted at the time of Specific Plan approval, included as Appendix E for future reference, would not change if County standards or plate numbers change unless a revised Specific Plan is approved.



Source: AECOM 2016

Figure 3-1: Roadway Classification Diagram

**Principal Arterial Road**

Fink Road is located at the southern boundary of the Plan Area. Figure 3-2 shows the cross section for the segment of Fink Road adjacent to the CLIBP, which will have a unique design based on a modified County standard. The portion of Fink Road between I-5 and Bell Road will be improved as a two-lane road, and eventually will include paved shoulders on both sides, a center-aligned left-turn lane, and a wide stormwater drainage swale on the section of Fink Road adjacent to the CLIBP. In the long-term, Fink Road will be improved in accordance with County Standard Plate 3-A16 to include four travel lanes within a 135-foot right-of-way (ROW) to accommodate future increase in traffic volume. A segment of Fink Road that is adjacent to the southern CLIBP boundary crosses the Delta Mendota Canal (DMC). Roadway improvements to Fink Road adjacent to the canal will require coordination with the Bureau of Reclamation.

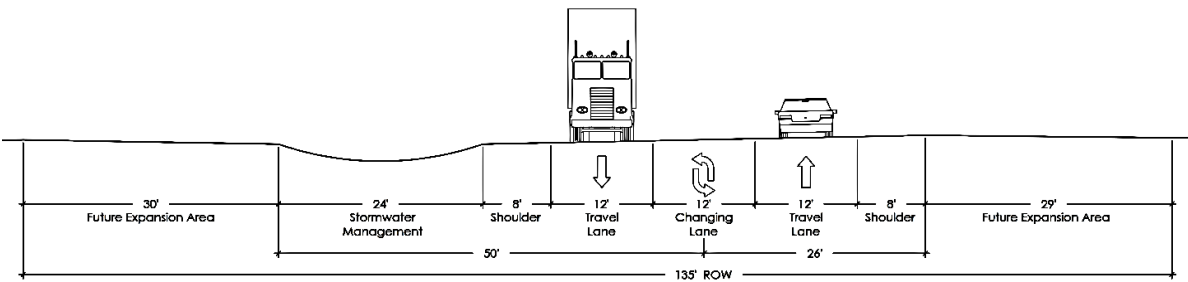


Figure 3-2: Fink Road (looking east) Near-Term Cross Section for Segment Adjacent to CLIBP

**Major Collector Road**

W. Marshall Road is located at the northern boundary of the Plan Area. Figure 3-3 shows the segment of W. Marshall Road adjacent to the CLIBP, which will be constructed using a unique design that is based on a modified County standard. The road segment will include four travel lanes, one center-aligned left-turn lane, and a wide stormwater drainage swale on the southern side of the road. Until traffic volumes trigger an upgrade, the segment of W. Marshall Road between the CLIBP and Ward Avenue will be improved in accordance with County Standard Plate 3-A13, which includes two lanes and narrowing at the DMC, and allows for future expansion as a four-lane major collector road.

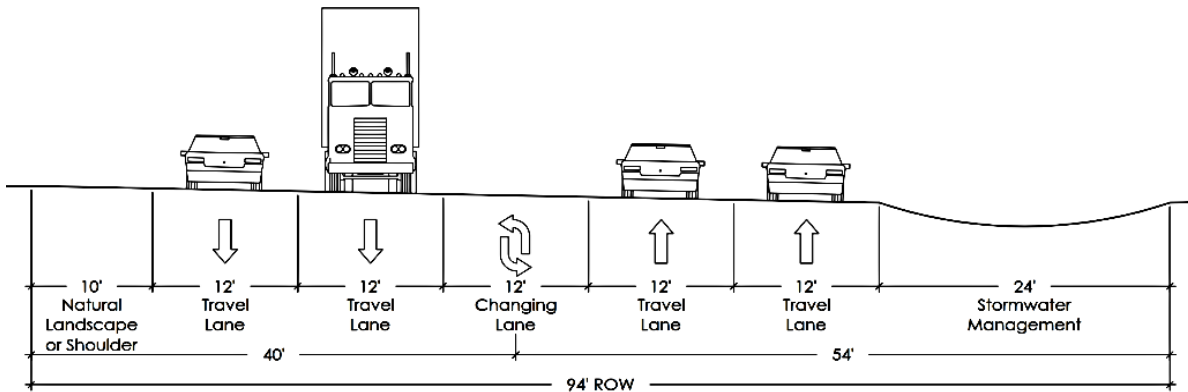


Figure 3-3: W. Marshall Road (looking east) Cross Section for Segment Adjacent to CLIBP

**Minor Collector Road**

W. Ike Crow Road, east of the Plan Area, will be a two lane minor collector road in accordance with County Standard Plate 3-A12, which allows for a future bike lane, if needed.

**Local Rural Roads**

Local rural roads within the Plan Area include Davis and Bell Roads. The section of Davis Road adjacent to the CLIBP will have a unique design that is based on a modified County standard to include a wide drainage swale (see Figure 3-4). The portion of Davis Road between Fink Road and the CLIBP will be a two lane road in accordance with County Standard Plate 3-A11.

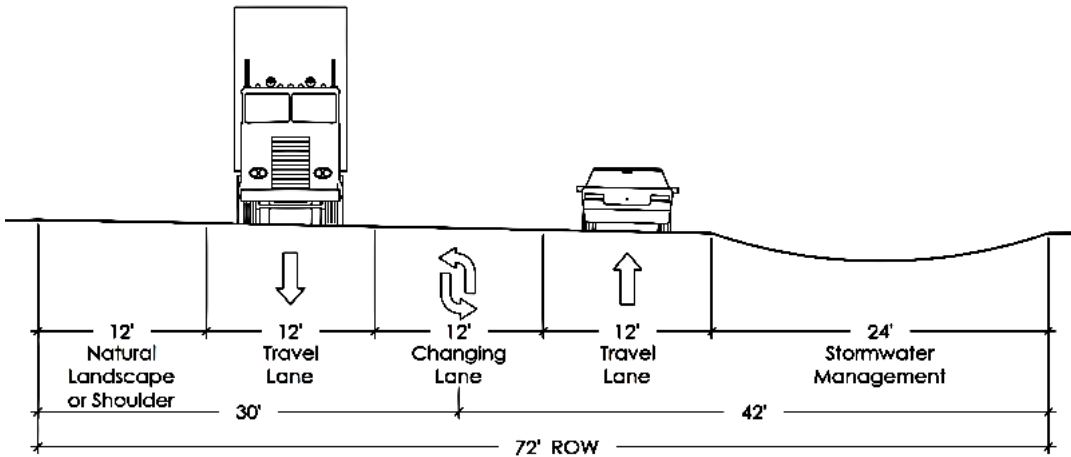


Figure 3-4: Davis Road (looking north) Cross Section Adjacent to CLIBP

The portion of Bell Road between Fink Road and W. Ike Crow Road is also envisioned as a unique local rural road with a wide swale and a multimodal (bicycle/pedestrian) path along the west side of the roadway and outside of the airport fence(see Figure 3-5). Bell Road will consist of two travel lanes, one center-aligned left-turn lane, and a bicycle/pedestrian path separated from vehicle traffic by a wide stormwater drainage swale. The multimodal path will connect to a multimodal path north of W. Ike Crow Road, which will have attractive aviation-compatible landscaping

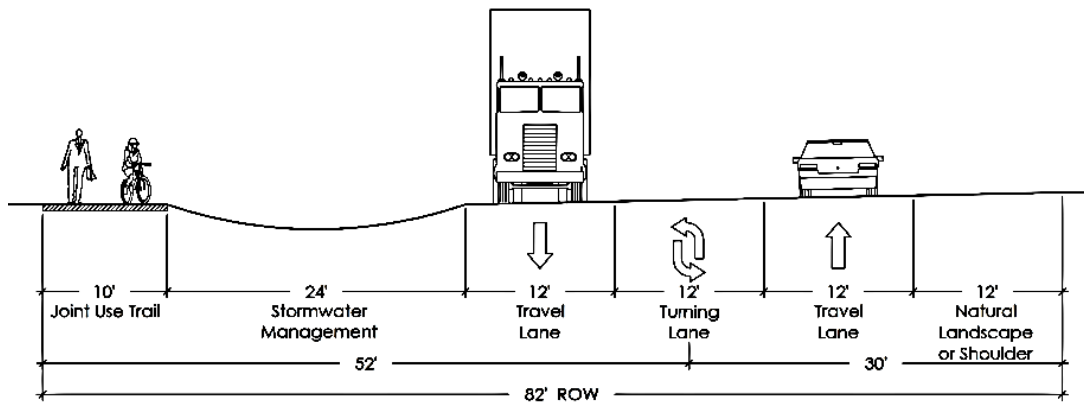
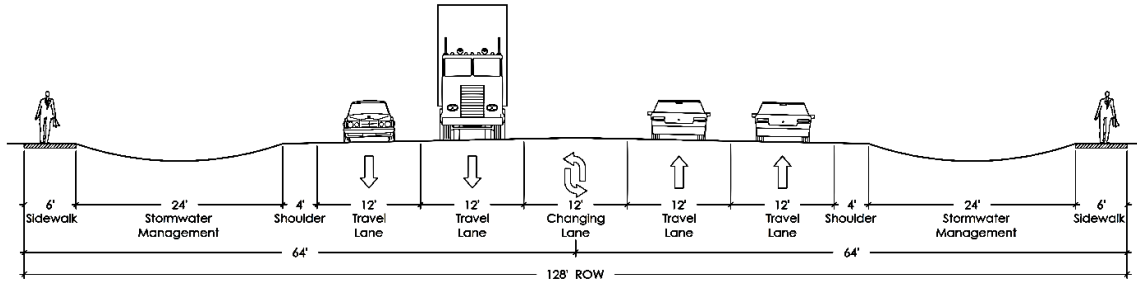


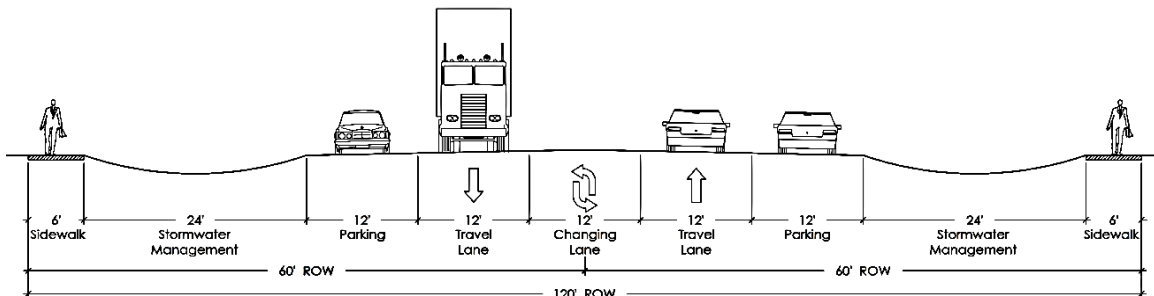
Figure 3-5: Bell Road (looking north) Cross Section between Fink Road and W. Ike Crow Road

### ***Typical Local Industrial Roads***

The typical ROW for new local industrial roads within the Plan Area has a 120-foot ROW with two travel lanes, one center-aligned left-turn lane, a parking lane, wide drainage swale, and sidewalk on each side (see Figure 3-6). The northern portion of the local industrial road that intersects with the W. Marshall Road gateway entrance will require widening to accommodate four travel lanes. This cross section will maintain the 120-foot ROW and will consist of four travel lanes, one center-aligned left-turn lane, as well as paved shoulder, wide drainage swale, and sidewalk on each side (see Figure 3-7).



*Figure 3-6: Typical Local Industrial Road, Two-Lane Cross Section*



*Figure 3-7: Typical Local Industrial Road, Four-Lane Cross Section*

### ***Local Access Roads***

In addition to the local industrial roads that provide internal industrial business park circulation, local access roads will be provided to support access to lots and businesses in the Plan Area. When possible, the local access roads will provide shared access and driveways to multiple buildings/developments. Figure 3-1 suggests general locations of these roads for illustrative purposes only. The number, location, alignment, and cross-sections for these roads will be determined for specific development projects at the time of County site plan review based on the need for internal connections among individual buildings and developments as described in Table 3-1.

### ***Bicycle Circulation***

Bicycle facilities that will be provided within the Plan Area include:

- Class 3 multimodal (bicycle/pedestrian) path along the CLIBP eastern boundary, north of W. Ike Crow Road.
- Internal bikeways, where appropriate and logical, to connect development internally within the Public

Facilities and Industrial Business Park Areas.

The Stanislaus Council of Governments (StanCOG) Non-Motorized Transportation Master Plan designates SR 33 as a Class 3.5 bikeway or signed bicycle route with wide shoulders. Bicycle facilities within the Plan Area will provide a connection to the designated bike route and may consist of a separate joint-use path or designated bike lane within the ROW shoulder area.

### 3.3.2 Streetscape and Landscape Framework

#### *Streetscape and Landscape Design*

The streetscape along Plan Area roads will be designed to establish an attractive and safe work environment by integrating a variety of plant materials, stormwater drainage swales, sidewalks, lighting, and signage in a consistent and creative manner. Climate-appropriate, low-maintenance landscaping (i.e., street trees, shrubs, and groundcover) are envisioned to create a unique local character for the CLIBP, while also providing shading and accents to Plan Area roads. Landscape materials along roads, at gateway entrances, and within common open space areas will be designed to support seasonal variations and changes in color, scale, and texture, and will accentuate intersections, gateway entryways, and common open space areas.

Landscaping within the public realm will be used as a transition to soften the buildings and built edges of private development, including parking areas, fences, and service areas. The following policies will apply to the streetscapes and landscapes within the Plan Area. (Refer to Appendix B for design and development standards for streetscape and landscape design.)

#### *Landscape Design Policies*

Landscaping is an important identifying element in the overall Plan Area development.

- D 1: Landscape design themes within the Plan Area shall draw inspiration from the aviation theme present within the landscape and structures in the former air facility, while respecting the rural landscape and broad open space that characterizes the surrounding area.
- D 2: Landscaping shall employ a mix of trees, shrubs, and groundcover, as suggested by the plant palette in Figure 3-8. Water-conserving/drought-tolerant plants, including California natives and other climate appropriate trees, shrubs, and groundcover, shall be used to comply with state and County water-efficient landscape standards and to reduce maintenance costs. Xeriscape techniques are encouraged to achieve water conservation and low maintenance goals. Plants shall be native or adaptable to local climate conditions and require little or no supplemental irrigation water once established.
- D 3: Landscaping and groundcover shall be employed to reduce or prevent erosion on steep slopes or along drainage courses.
- D 4: Street trees, shrubs, and groundcover shall be selected to support the overall landscape theme within the Plan Area, such as accentuating entrances, landmarks, and common areas.
- D 5: Landscaping designs and the selection of planting materials must consider the presence of the on-site airport and must not be attractive to potentially hazardous wildlife. (Refer to Design Goal 6 and the design and development standards in Appendix B for additional guidance.) **Applicants who wish to propose similar alternative plant materials to those**

suggested by the palette in Figure 3-8 may be required to submit the proposed plant palette for review and approval by a Federal Aviation Administration (FAA) qualified Airport Wildlife Biologist.

### *Site Furnishing and Lighting Policies*

Well designed, easy-to-maintain, and durable street furniture and lighting will be provided in the Plan Area to encourage pedestrian use. Lighting levels for street lights will be adequate to illuminate the intended space and support the safety of CLIBP users and workers and will not conflict with aviation activities. (Refer to Appendix B for design and development standards for site furnishing and lighting.)

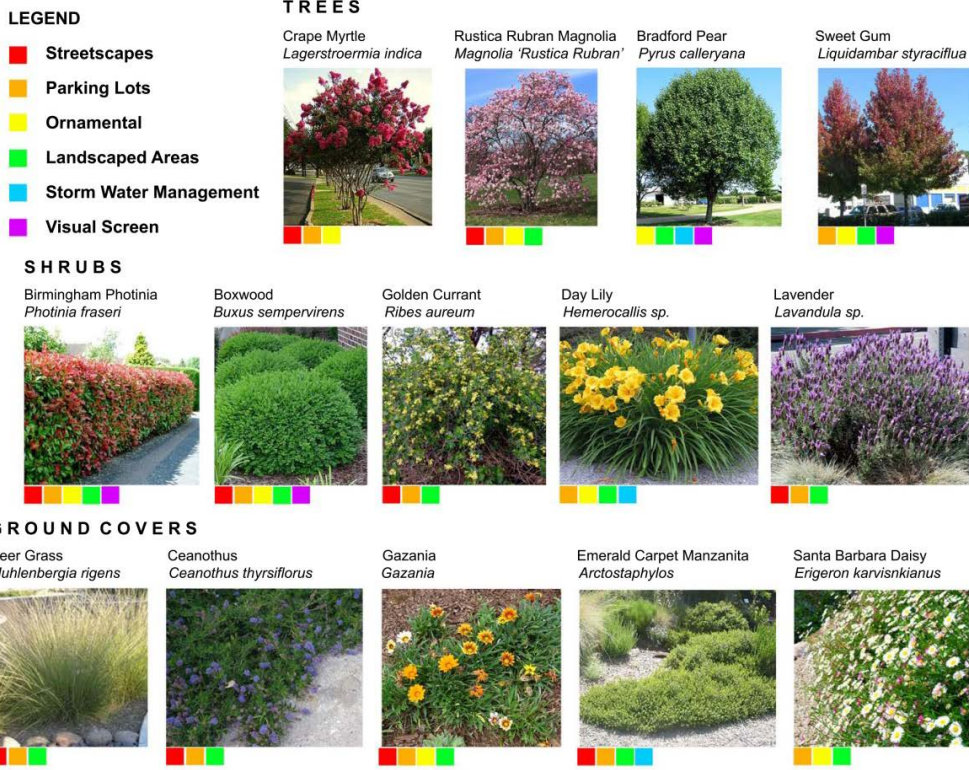
- D 6: Bus shelters shall be permitted near intersections within the space allocated to parking areas on the local industrial roads provided the County determines the location meets applicable County or public transit agency specifications for bus access and an off-road bus stop.
- D 7: Pedestrian-oriented street furniture shall be encouraged and permitted within the front setback area of a leasehold (lot), provided their placement does not interfere with pedestrian movement or vision clearance requirements.
- D 8: A coordinated system of street furnishings and lighting shall be selected to complement the overall landscape design theme for the Plan Area and appropriate to the function and use of site development.
- D 9: The design, materials, and finishes used for street furniture and lighting shall be low-maintenance, suitable for the climate, and vandal-resistant.
- D 10: Illumination standards for roads shall respond to the ROW widths and road functions.
- D 11: Lighting fixtures and illumination shall be equipped with downward-facing shields and shall not conflict with aviation activities.

### *Gateway Entryway and Common Open Space Area Features*

Gateway entryway features will be provided to the CLIBP Plan Area on Fink Road, Bell Road (at W. Ike Crow Road), and W. Marshall Road (see Figure 3-1). Examples of architectural and thematic approaches for gateway entryway features are shown on Figure 3-9. (Refer to Appendix B for design and development standards for gateway entryway features.)

- D 12: Gateways entrances shall include vertical architectural monumentation, hardscape and landscape elements, and public art to create visual interest for users, visitors, and passersby.  
  
Landmarks and public art shall be encouraged in common open space areas or as focal points within the industrial business park. A landmark feature could be constructed as a monument, such as the former air traffic control tower (ATCT), special entryway signage, or another feature that complements the overall signage program and landscape treatments in the Plan Area.





**General Criteria For Plant Selection**

Trees	Shrubs	Groundcover	
<p>Shall be low-growing varieties so as not to intrude upon navigable airspace at maturity. Tree sizes shall range between maximum heights of 30 to 45 feet.</p> <p>Trees must not produce nuts, fruit, drupes or berries that can provide food for wildlife.</p> <p>Trees should not provide a continuous canopy.</p> <p>Vertical branch structure is preferred.</p> <p>Other varieties to consider: Desert Willow (<i>Chilopsis linearis</i>) and Palo Verde (<i>Cercidium floridum</i>).</p>	<p>Must not produce nuts, fruit, drupes, berries, or other food sources for wildlife.</p> <p>Other varieties to consider: Australian mirror bush (<i>Coprosma sp.</i>) and Forsythia.</p>	<p>Shall provide an average height of 6 to 12 inches (Heights of less than 6 inches encourage or provide opportunities for loafing and foraging, whereas heights of greater than 12 inches can harbor wildlife).</p>	<p>Plantings for stormwater drainage swales with low-growing or groundcover plants that are 6 to 12 inches in height could include: Common Rush (<i>Juncus effusus</i>); Western Columbine (<i>Aquilegia formosa</i>); Scarlet Monkeyflower (<i>Mimulus cardinalis</i>); Globe Sedge (<i>Carex globosa</i>); Douglas Iris (<i>Iris douglasiana</i>); Blue-eyed Grass (<i>Sisyrinchium bellum</i>); and Yerba Buena (<i>Satureja douglasii</i>).</p>

Figure 3-8: Proposed Landscape Palette



*Archway / Canopy Gateway Feature*



*Horizontal Monument Gateway Feature*



*Wall Gateway Feature*



*Vertical Monument Gateway Feature*

*Figure 3-9: Examples of Gateway Features*

### 3.3.3 Open Space Framework

#### *Site Edges and Agricultural Buffers*

The Plan Area is surrounded by agricultural land. Therefore, the design treatment selected for the Plan Area perimeter must provide a visual separation between the CLIBP and its adjacent rural landscape, which includes residences, access roads, viewpoints, and agricultural areas. The use of special design treatments at the Plan Area boundaries will create a distinct identity for the CLIBP Plan Area and help to avoid conflicts with nearby agricultural uses. (Refer to Appendix B for design and development standards for site edges and agricultural buffers.)

- D 13: A landscaped corridor that includes aviation-compatible native and low-maintenance groundcover, shrubs, other vegetation, and a bicycle/pedestrian path shall be designed north of the portion of W. Ike Crow Road that is adjacent to the Plan Area eastern boundary. The corridor will provide a visual screen between Plan Area buildings and adjacent agriculture use.
- D 14: Buildings located adjacent to the Plan Area boundaries shall include adequate setbacks from adjacent agricultural uses. Setback areas may consist of road and other rights-of-way, parking areas, and landscaping that provide a visual screen and separation from adjoining agricultural uses.

### 3.3.4 Signage and Wayfinding

A coordinated signage and wayfinding program is envisioned for the Plan Area that will be consistent with on-site architecture and landscaping and will provide identification, direction, and necessary information to CLIBP users and visitors.

At least three types of signs will be necessary.

- **Street Signs and Place Markers** will be required to identify all roads in the Plan Area and to identify key features such as bicycle/pedestrian facilities and monuments.
- **Industrial Business Park Identification and Wayfinding Signs** will convey a consistent identity of the CLIBP, identify CLIBP boundaries, and provide direction and information to CLIBP users and visitors.
- **Tenant Identification Signs** will identify individual businesses and tenants.

The following policies will guide the comprehensive design, location, and legibility of signs in the Plan Area and help create an overall identity for the CLIBP. (Refer to Appendix B for design and development standards for signage.)

- D 15: Signs shall be consistent throughout the Plan Area to enhance the identity of the CLIBP.
- D 16: Signs shall be located to be visible from roads and paths, without conflicting with safe vehicular movement and visibility.
- D 17: The type of signs used shall be designed as a group, incorporating similar, compatible materials that reinforce the design and style of the overall Plan Area or associated project design.
- D 18: Signs shall be constructed to be compatible with safe aviation in terms of their associated heights, illumination, perching potential, etc.

### 3.3.5 Sustainability

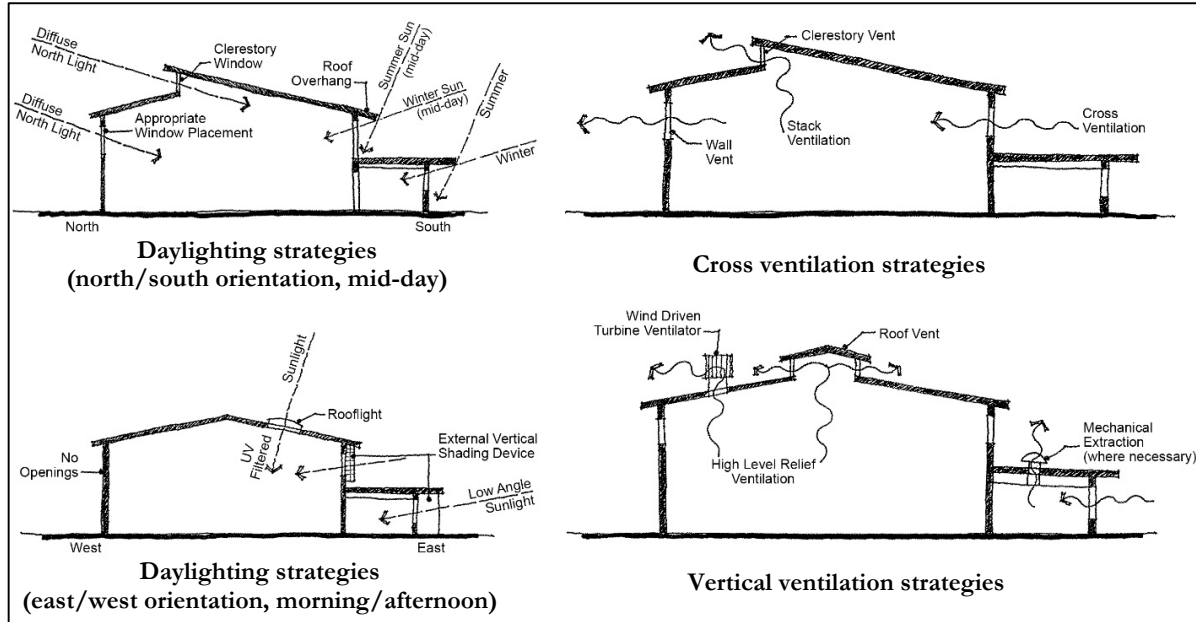
#### *Energy Conservation Policies*

One of the primary objectives of the CLIBP project is to provide local employment opportunities through the creation of a regional job center and to reduce the number of commuter vehicle miles traveled and subsequent vehicle emissions (see Chapter 1, “Introduction,” Objective 2). Another project-related objective is to encourage the use of sustainable design and implementation of federal, state, and local energy and water conservation requirements (see Chapter 1, Objective 6).

The following policies will promote sustainable development in a manner that meets or exceeds the State of California’s minimum standards for building energy efficiency standards, the CalGreen Code, and other applicable codes and regulations.

- D 19: All development shall consider proposed site, building, and landscape design features that minimize energy demand, lower operational costs, and reduce air emissions associated with facility operations.
- D 20: All development shall be encouraged to incorporate energy-efficient design concepts, building systems, and alternative energy sources. To the greatest extent possible, new development should incorporate the following measures:
- Application of Leadership in Energy and Environmental Design (LEED) Green Building principles and certification.
  - High-performance buildings materials, including glass and insulation.
  - Renewable energy technologies, such as solar water heaters, solar panels, and other on-site installed solar facilities, wind, or geothermal energy collectors or active solar energy generation systems. The County must determine that the use of these renewable energy technologies is compatible with airport operations and FAA requirements.
  - Computerized controls to monitor temperatures in tenant spaces and to adjust heating and cooling.
  - Lighting controls to monitor and adjust lights for work, security, or other functions.
  - Energy star appliances, lighting, and equipment.
  - Radiant floor heating system in large spaces.
  - Roll up or sliding doors in large spaces for natural ventilation during temperate weather.
  - Building placement to take advantage of passive heating and cooling, including within open space areas. Buildings should be adequately separated from each other to avoid obstructing solar access, especially during winter months.
  - Trees and earth sheltering with creative land grading to shade building entrances and parking areas.
  - Passive design strategies within buildings for natural heating, cooling, lighting and other energy saving opportunities.

- Operable windows, skylights, and fans to reduce mechanical ventilation and cooling.
- Windows, doors, and rooftops arranged to maximize natural ventilation and daylighting.
- Active solar energy technologies on large roof areas and in open spaces.



*Passive design strategies for daylighting and ventilation in buildings help optimize energy conservation.*

### ***Stormwater and Water Quality Management Policies***

The application of best practices in stormwater and water quality management will be integral to Plan Area design. Water-sensitive urban design features, such as the use of stormwater drainage swales along roads, have been incorporated into the Plan Area design to ensure that stormwater runoff from new development is detained on-site for irrigation use, to mitigate potential localized or downstream flooding effects, and to protect water quality. However, on-site stormwater and water quality management systems must not be designed so as to enhance habitat or attract potentially hazardous wildlife to aviation.

The CLIBP stormwater and water quality management programs are described in Chapter 4, “Infrastructure,” of this Specific Plan. Policies guiding the stormwater and water quality management strategies to be implemented in the Plan Area include:

- D 21: New stormwater facilities shall incorporate natural drainage systems that can connect with proposed on-site drainage facilities.



*Water-sensitive design techniques shall be incorporated into site design.*

- D 22: Low-impact development standards shall be implemented in accordance with all applicable federal, state, and local permit requirements.
- D 23: Every leasehold (lot) within the Plan Area shall detain all stormwater on-site and comply with the Stanislaus County Department of Public Works standards for storm drainage, including the current design storm and detention options. (Refer to Stanislaus County Public Works Standards and Specifications in effect at the time of development for detailed process and requirements.)
- D 24: The use of turf for landscaping shall be strictly prohibited.
- D 25: Water metering of individual units or spaces in a multi-tenant building shall be required.

### 3.4 PRIVATE REALM DESIGN

#### 3.4.1 Building Siting and Orientation Policies

Building siting and orientation will strive to create an attractive public realm streetscape environment. Primary building frontages and entries should be sited to face roads, and buildings should be oriented to maximize energy efficiency by incorporating passive and active design elements. When possible, buildings should be oriented to maximize the potential use of natural daylighting and active solar energy systems that are compatible with aircraft operations, as noted in policy D-28 (renewable energy technologies).

The following building siting and orientation guidelines apply:

- D 26: Buildings should be sited to enhance the character of existing landforms and site features, strengthen the relationships between buildings, and facilitate pedestrian and vehicular circulation.
- D 27: Buildings should be designed and sited to maximize the use of natural daylight, passive heating and cooling strategies for energy savings, and to respect the solar access requirements of adjacent (existing and proposed) buildings).

#### ***Building Setbacks***

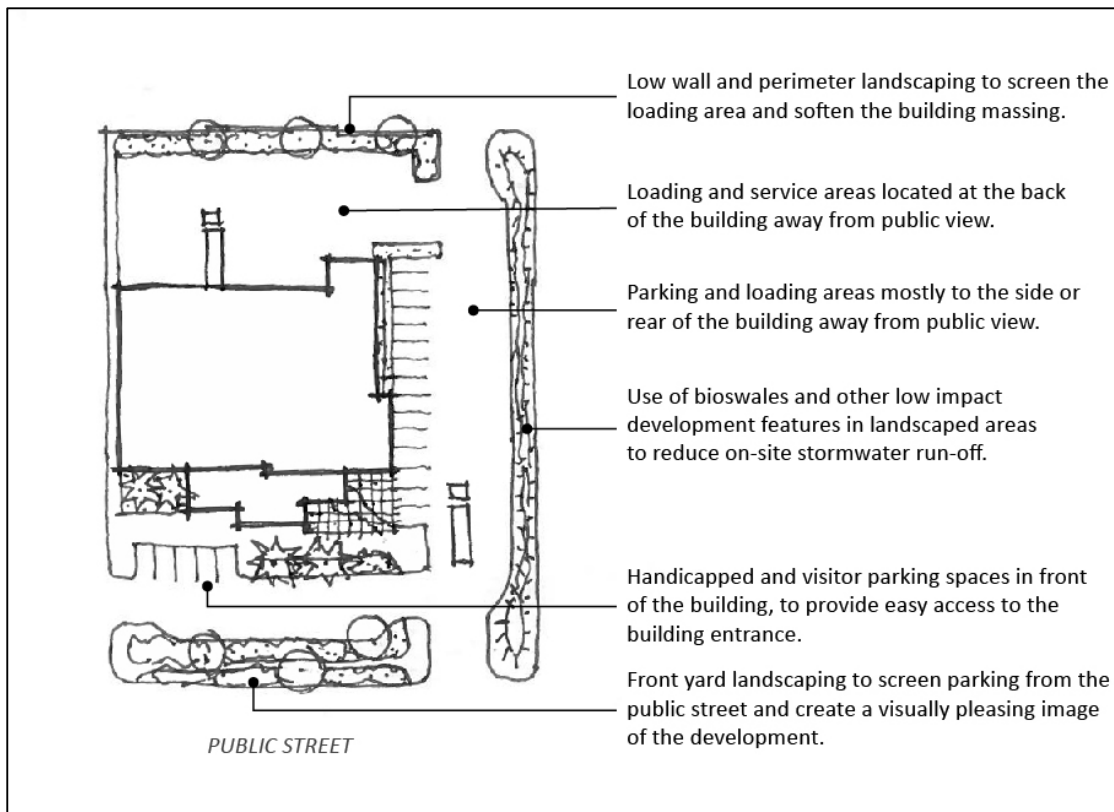
All buildings and parking areas should include a sufficient set back from perimeter and interior roads to establish a distinct, well landscaped public-realm environment. Setbacks along roads will facilitate the use of landscaped buffers to screen or provide a visual distraction from parking areas. Building setbacks should be landscaped to create a cohesive image and identity for the CLIBP. The use of different building setbacks for different land uses may help to enhance visual interest along the road and present a distinct identity for each use. (Refer to Appendix B for design and development standards for building setbacks.)

- D 28: Architectural projections that are not included in the floor area, such as roof eaves or other architectural enhancements, should not encroach more than three (3) feet into a building setback area.
- D 29: Building setbacks may be varied to accommodate pedestrian amenities and to create variation within a campus-style development.

*Site Design and Layout Principles*



*This light industrial building entrance is both distinctive and welcoming, which contributes to the building's identity. The horizontal canopy and vertical walls shade the entrance to keep it cool in the summer and partially buffer it from strong winter cross winds.*



Source: AECOM 2017

Figure 3-10: Example of Site Design and Layout



### 3.4.2 Building Façade and Articulation Concepts and Policies

The architectural design for each building in the Plan Area should reflect its specific function. This applies to all Plan Area buildings, including warehouses, which may be strictly utilitarian in function and character.

While design variations and flexibility are encouraged for individual buildings, each design must also promote an overall sense of cohesiveness and identity for the CLIBP. For the type of industrial uses planned, the range of architectural and site plan treatments will likely focus on providing a cost-efficient design that is also clean, distinct, durable, and long lasting. (Refer to Appendix B for design and development standards for building and architecture.



*Clean lines, articulated structural bays, and different materials can be used to break up the mass of large buildings.*

- D 30: Square, box-like structures with large, blank, unarticulated wall surfaces are not an acceptable development form. Building facades should be broken up by their structural bays and incorporate architectural features and patterns that provide visual interest at the scale of the pedestrian and reduce the appearance of mass.

#### ***Building Height, Scale, and Massing***

- D 31: The height of new development should be compatible with and transition from the height of adjacent development, when designed to be two or more stories.
- D 32: Building heights, including antennae and other appurtenances, should not conflict with navigable airspace as defined by FAA at 14 CFR Part 77, “Safe, Efficient Use, and Preservation of the Navigable Airspace,” and shown on the Crows Landing Airport Layout Plan (ALP).

#### ***Colors, Materials, and Finishes***

- D 33: Earth-tone colors should be used as the base color for proposed structures to be compatible with nearby agricultural uses. Brighter or more intense colors may be used as accents for trims, doors, window frames, etc., as long as they complement the colors of the overall structure.

- D 34: Exterior materials shall be selected to minimize any potential glare to surrounding development and aircraft operations.
- D 35: Exterior materials for buildings should be of high quality and durability to support the overall high quality of design and development desired within the CLIBP.
- D 36: A variety of building materials and textures in combination with landscape and lighting treatments is encouraged to provide visual interest and activate the building development.
- D 37: Use of recycled, local, and/or rapidly renewable materials is encouraged.
- D 38: Use of low volatile organic compound (VOC) and non-toxic building finishes is encouraged.
- D 39: Structures shall avoid the use of overhead grids, cavities, or other features that could provide refuge or nesting habitat for wildlife. If necessary, structures shall be equipped with anti-perching devices.



*A variety of building materials and colors, in combination with paving and lighting, should be used to accentuate the building.*

### 3.4.3 Circulation and Parking

On-site circulation, ingress, and egress should minimize conflicts among various travel modes; demarcate areas for pedestrians, bicyclists, cars, and service vehicles; and guide the overall configuration and appearance of parking areas. (Refer to Appendix B for design and development standards for circulation and parking.)

- D 40: The parking lot and vehicles should not be the dominant visual elements of the site. Large paved lots should be avoided in favor of multiple smaller parking areas, separated by landscaping, walkways, and buildings. Parking should be strategically located away from pedestrian traffic routes, when possible.
- D 41: Site access and internal circulation should be designed to emphasize safety and efficiency and to reduce conflicts between vehicular and pedestrian traffic.

#### 3.4.4 Loading and Service Areas

- D 42: The placement and design of loading and service areas should be avoided at building or leasehold (lot) street area frontages and designed in accordance with the design and development standards in Appendix B.
- D 43: Development should screen or conceal loading areas/docks, outdoor storage, and service areas for trash and utilities in view of a public space and roads to the greatest extent possible. Screening materials should be designed to blend in with the landscape and architectural design of the development.

#### 3.4.5 Aviation Considerations

The CLIBP Plan Area includes the 370-acre Crows Landing Airport. Proposed land uses and design and development standards included in this Specific Plan have been developed to optimize compatibility with the new public-use airport.

All proposed development within the Plan Area will be located within the Airport Influence Area (AIA) associated with the Crows Landing Airport (see Chapter 1, Figure 1-5), and all proposed projects must comply with the Stanislaus County ALUCP.

ALUCP policy considerations include:

- Aircraft noise exposure and the need to provide sound insulation;
- Safety Considerations (land uses, densities, and intensities);
- Navigable airspace and heights of structures;
- Overflight awareness;
- Other hazards to aircraft, such as glare, smoke, electronic interference, and hazardous wildlife.

#### 3.4.6 Airport Development

All airport development shall be designed in accordance with appropriate federal and state regulations and guidance pertaining to airport design and development, including FAA Advisory Circular 150/5200-13A, "Airport Design," as amended, state regulations, and other pertinent guidance. Should conflicts between federal or state aviation regulations/guidance and CLIBP Specific Plan policies occur, the aviation regulations/guidance shall prevail.

All proposed airport facilities must appear on/comply with the Crows Landing ALP, or the ALP must be amended to include the proposed facilities. In addition, all proposed ALP revisions must be reviewed to determine their consistency with the Stanislaus County ALUCP. In such cases, environmental review may be warranted.

The County will ready the Crows Landing Airport for site development and tenant use by designating and readying sites for hangar development and fixed-based operations. The following policies shall apply to airport tenants and users, as well as the specific conditions associated with lease agreements:

- 
- D 44: The airport and its facilities shall only be used for aviation-related purposes. Airport-related uses that do not require the use of airport facilities will be sited outside of the airport boundaries.
- D 45: Hangars and aircraft parking areas shall be used only for the storage and maintenance of aircraft. Boats, trailers, other vehicles, or equipment may not be stored at the airport under any circumstance.
- D 46: All facilities constructed on airport property by the County or others, shall be constructed and maintained to provide an attractive aviation facility as described in Section 3.4.

This page intentionally left blank





## 4.1 OVERVIEW

Chapter 4 provides a plan for the orderly and cost-effective development of on-site and nearby infrastructure needed to support each phase of development envisioned for the Crows Landing Industrial Business Park (CLIBP) Specific Plan area (Plan Area). Infrastructure includes a surface transportation system; a potable and non-potable water supply and distribution system; wastewater collection and treatment; stormwater management, including features for groundwater recharge; dry utility networks; and solid waste service. This chapter also addresses key environmental considerations associated with water quality and conservation.

“Backbone” infrastructure is defined as major public improvements designed to serve the entire Plan Area or substantial portions of the Plan Area, and is the minimum required to support phased on-site development based on proposed land uses and development densities/intensities. The backbone infrastructure systems described in this chapter are conceptual in nature and may be modified during CLIBP build-out based on changes in technology or the location and intensity of future development.

The County will initially make infrastructure improvements for development in the southern portion of the Plan Area (Fink Road Corridor) during the first five years of development, which is referred to as Phase 1A (see Chapter 2, “Land Uses,” Figure 2-2). Initial Plan Area development in the Fink Road Corridor takes advantage of the CLIBP’s proximity to Interstate Highway 5 (I-5) using the Fink Road/I-5 interchange. The Fink Road Corridor is envisioned to support primarily logistics, warehouse, and distribution uses because of its proximity to I-5, but it may accommodate other uses. Infrastructure improvements for development in the Bell Road Corridor, airport, and southern portion of the Public Facilities Area will be made during years 6 to 10 (Phase 1B). A strategy for infrastructure phasing and financing is provided in the CLIBP Infrastructure Financing Plan (Appendix K).

### 4.1.1 Infrastructure Goal

The following goal applies to all components of the CLIBP Plan Area’s proposed infrastructure:

- IG 1: Provide infrastructure, including roads; potable and non-potable water supply and distribution; wastewater collection and treatment; stormwater management, including features for groundwater recharge; electricity, natural gas, and communication networks; and solid waste service that will be sufficient to serve the projected growth and build-out of the CLIBP Plan Area.

### 4.1.2 Infrastructure Policies

The following policies apply to all components of the CLIBP Plan Area’s proposed infrastructure:

- IP 1: Promote the orderly and efficient construction or expansion of infrastructure and utilities to meet projected needs.
- IP 2: Implement capital improvements for needed service infrastructure in coordination with the direction, extent, and timing of Plan Area growth.
- IP 3: Establish equitable methods for distributing costs associated with Plan Area development, including the costs of on-site backbone infrastructure and regional serving off-site improvements needed for Plan Area development.
- IP 4: Design new infrastructure systems to consider life-cycle costs and to promote innovation in energy and water conservation.



## 4.2 TRANSPORTATION

The 1,528-acre former Air Facility property is generally bounded by W. Marshall Road to the north, State Route (SR) 33 to the northeast, Bell Road to the east, Fink Road to the south, and agricultural land and Davis Road to the west. Regional access to the Plan Area is provided by I-5 and SR 33, with local access provided by W. Marshall Road at the Plan Area's northern boundary and W. Ike Crow Road at its eastern boundary. Fink Road, to the south, provides regional access between the CLIBP and I-5 (see Figure 4-1). Currently, no public roadways provide access through the Plan Area.

### 4.2.1 Transportation Plan

The Transportation Infrastructure Plan – Crows Landing Industrial Business Park (Appendix F), referred to herein as the Transportation Plan, identifies the on-site interior or “backbone” roads that will be constructed in accordance with the phased site development presented in Chapter 2, “Land Uses,” and road design in Chapter 3, “Built Environment and Design,” as well as needed off-site improvements. The backbone roads will provide primary internal circulation and connections to the adjacent off-site roadway network.

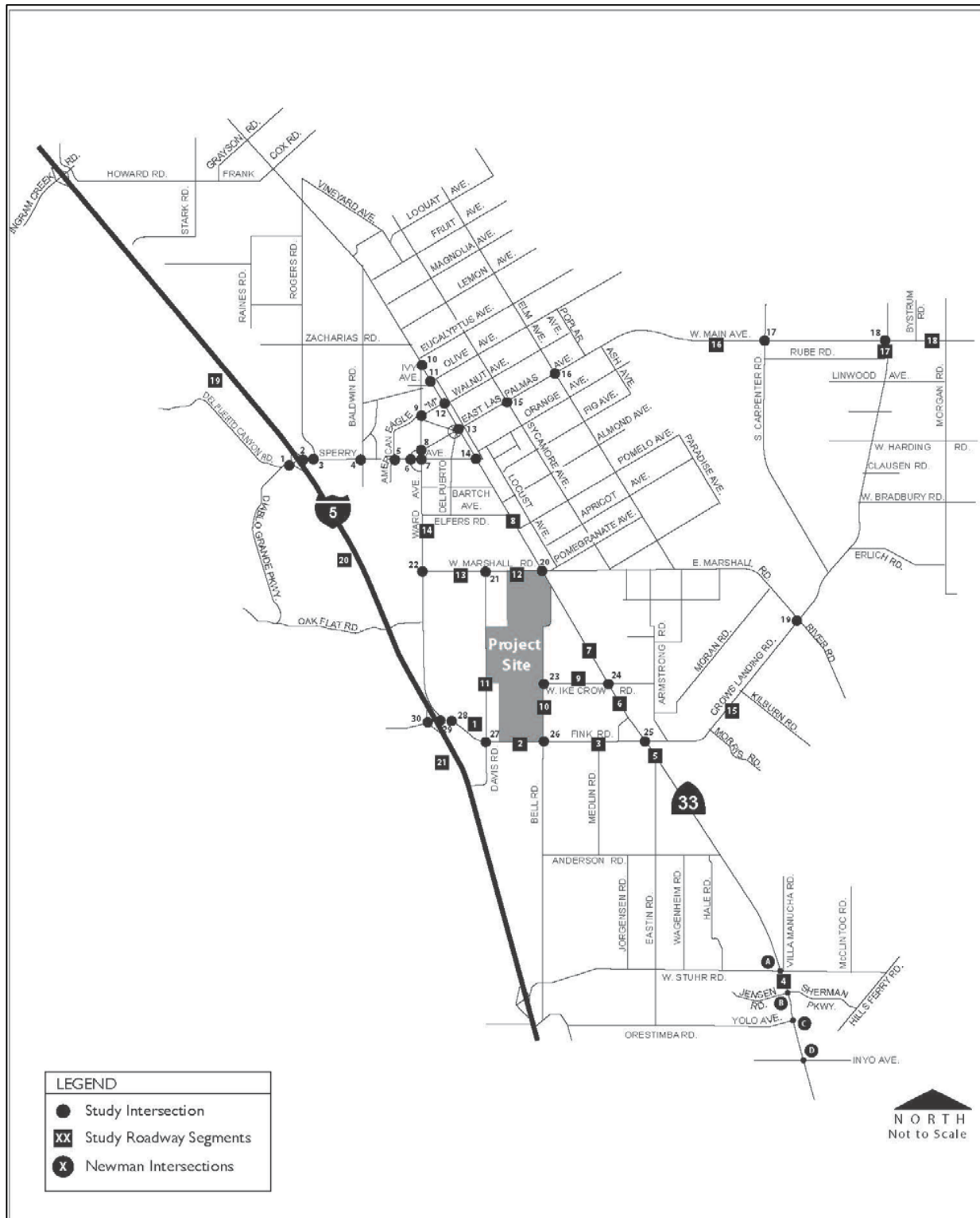
Figure 4-1 illustrates the existing roadways in the vicinity of the Plan Area. The 18 roadway segments, 3 freeway segments, and 34 intersections identified in the figure were studied in the Transportation Plan. All roadways studied are two-lane roads serving agricultural activities, incorporated areas, and nearby communities. According to the Transportation Plan, all 30 study area intersections currently operate at acceptable conditions. Furthermore, none of the non-signalized study area intersections currently exceed the County's congestion threshold for signal warrants based on their level of service (LOS). The County's current acceptable LOS for intersections is LOS C.

Approximately 14.3 million square feet of development and 14,447 jobs<sup>1</sup> are projected at CLIBP build-out. The Transportation Plan examines traffic impacts under existing conditions and analyzed impacts for three potential future scenarios:

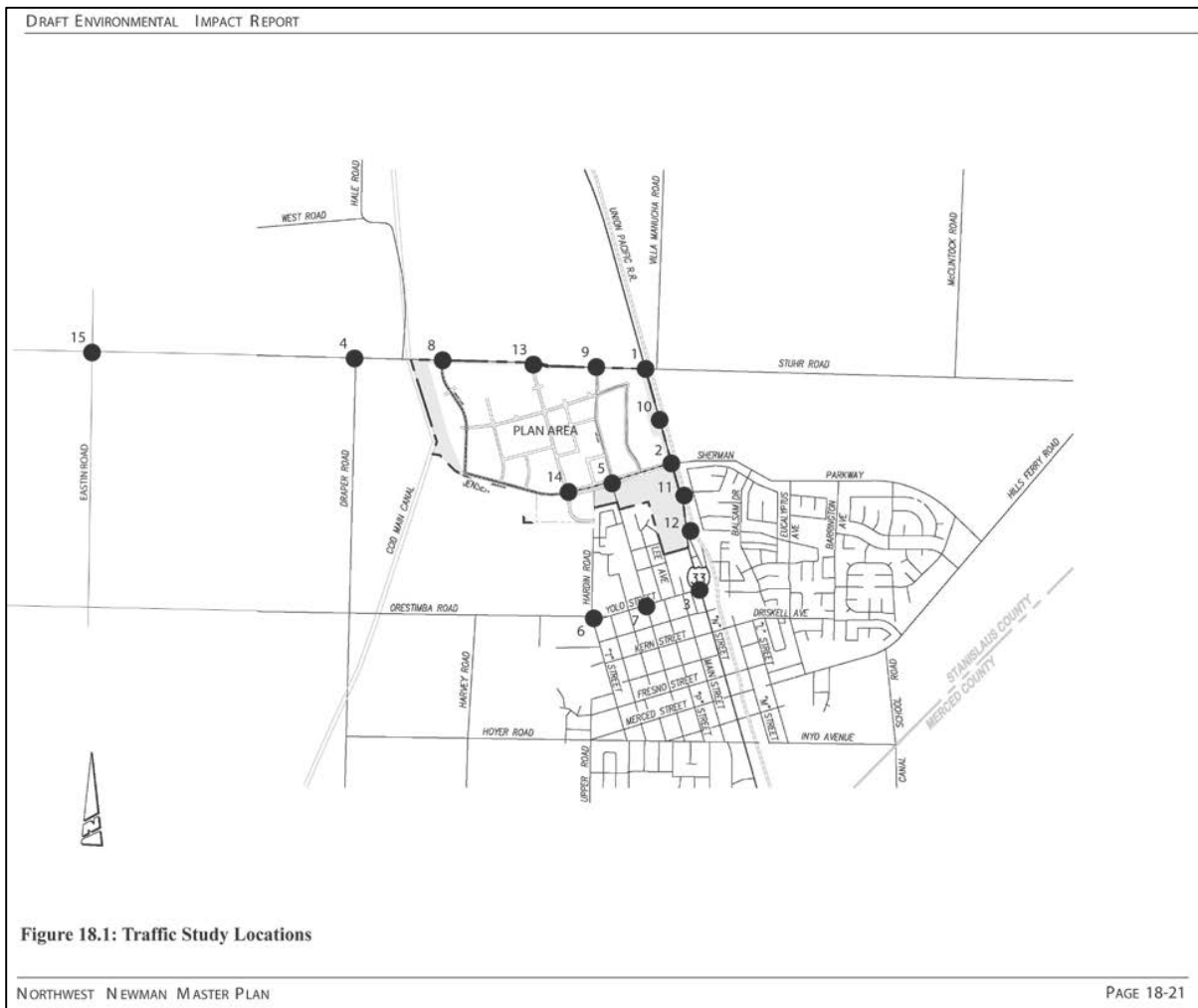
- Existing conditions plus the CLIBP project;
- Anticipated year 2035 traffic conditions, based on projected growth without the CLIBP project; and
- Anticipated year 2035 traffic conditions, based on projected growth with the CLIBP project.

Transportation network and land use information for the Tri-County area, (which is the basis for traffic projections in the Transportation Plan), including Merced, San Joaquin, and Stanislaus Counties was available through 2035, so the 2035 conditions assumes full CLIBP build-out and, thus, represents a conservative analysis. The Transportation Plan utilized near-term (next 20 years) with existing conditions to determine traffic impacts triggered by CLIBP development and therefore, the CLIBP's transportation improvement responsibilities, including cost. Additionally, the study analyzed traffic impacts and improvements needed based on CLIBP development and/or regional growth over the long-term (at 2035 and beyond), and the CLIBP's fair share of traffic demand, impacts, and additional transportation improvement responsibilities.

<sup>1</sup> Refer to the detailed Land Use and Employment Summary table, which is provided in Appendix A of the CLIBP Specific Plan, for additional information on estimated land use categories, extent of development associated with each phase, and employment projection at CLIBP build-out.



Source: TJKM 2018  
 Figure 4-1: Project Vicinity



Source: KD Anderson (2014)

Figure 4-2: Northwest Newman Master Plan EIR Traffic

Based on the results of the transportation analysis, several road segment, signalization, and interchange improvements were identified to support CLIBP development during both the near-term (through 2035) and long-term (beyond 2035). The Transportation Plan estimated the associated phase for each needed roadway project; however, the timing of roadway improvements will be based on monitoring of roadway conditions during CLIBP build-out.

To accommodate the development envisioned for the CLIBP Plan Area, the following types of transportation improvements will be needed:

- On-site backbone roads;
- Off-site roadway rehabilitation;
- Off-site roadway widening;
- Off-site signals; and
- Fink Road / I-5 interchange improvements.

The following sections identify the anticipated development or improvement of transportation infrastructure to facilitate CLIBP build-out as envisioned in three 10-year phases. However, the timing of proposed transportation improvements may be subject to change based on the needs of site users.

#### 4.2.2 Near Term Improvements Triggered by the CLIBP Project

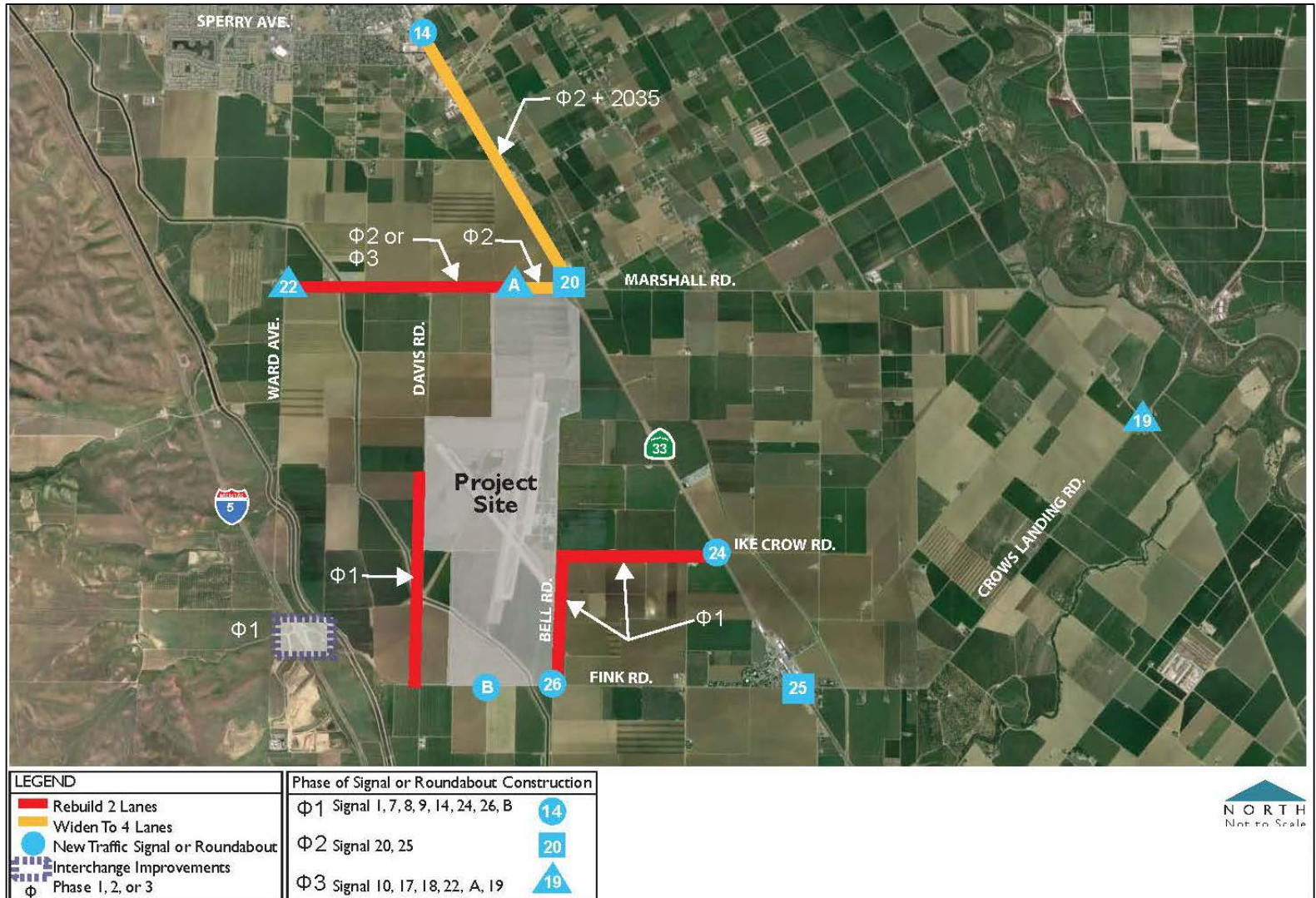
##### *On-Site Backbone Road Requirements*

Most Plan Area roadways will be constructed as local industrial roads using a two-lane cross section design (two travel lanes and one center-aligned left-turn lane) to provide internal site circulation (see Chapter 3, Figure 3-6). The only exception will be a four-lane cross section design (four travel lanes and one center-aligned left-turn lane) associated with the CLIBP north access point from W. Marshall Road, where a larger volume of traffic is expected to enter the Plan Area at a single intersection (see Chapter 3, Figure 3-7). Based on user need or as demand warrants, internal circulation roads with greater traffic demand may require additional improvements. Figure 2-2 (see Chapter 2) identifies the first four roadway segments that will be constructed during Phase 1 of Plan Area development. On-site backbone roads to be constructed during Phases 2 and 3 are shown as broken lines north of the airport.

##### *Off-site Roadways Requiring Rehabilitation/Rebuilding*

Four segments of two-lane roadways adjacent to the CLIBP will be rehabilitated to support CLIBP-related traffic (see Figure 4-3).

- **W. Ike Crow Road – Bell Road to SR 33.** This segment of W. Ike Crow Road should likely be improved beginning or during Phase 1A, to comply with Stanislaus County Department of Public Works (SCDPW) roadway standards required from Plate 3-A12, 60 FT Minor Collector, and to allow a future bike lane, if needed. The County will begin improving W. Ike Crow Road in Phase 1A.
- **Bell Road – Fink Road to W. Ike Crow Road.** Improvements to this segment of Bell Road will be required during Phase 1 of Plan Area development, and will include a bicycle/pedestrian path (see Chapter 3, Figure 3-5). This roadway will also connect to a bicycle/pedestrian path and greenway that continues north from W. Ike Crow Road to W. Marshall Road/SR 33. The County will begin improving Bell Road in Phase 1A.



Source: TJKM 2018

Figure 4-3: Off-Site Road Improvements, CLIBP Project Area

- **Davis Road – Fink Road to CLIBP west entrance.** This segment of Davis Road is located west of and partially adjacent to the Plan Area. Improvements to Davis Road will be required during Phase 1 and will include the construction of the western entrance to the CLIBP. The portion of Davis Road that is not adjacent to the CLIBP will be improved to comply with SCDPW roadway standards required from Plate 3-A11, 60 FT Local Rural. The section of Davis Road adjacent to the CLIBP has a unique design that is based on a modified County standard to include a wide drainage swale (see Chapter 3, Figure 3-4). Davis Road includes a bridge that crosses over the Delta Mendota Canal (DMC). The existing bridge appears to have adequate width to accommodate the improvements. The County will begin improving Davis Road in Phase 1B.
- **W. Marshall Road – Ward Avenue to CLIBP entrance.** This segment of W. Marshall Road will be improved to comply with SCDPW roadway standards required from Plate 3-A13, 80 FT Major Collector. This segment of W. Marshall Road includes a series of power poles, which are considered immovable objects. The poles are located on the north side of the road between the CLIBP and the east side of the DMC, and on the south side of the road west of the electrical substation located just east of the DMC. A 20- to 22-foot-wide bridge conveys W. Marshall Road across the DMC, and the bridge was determined to be marginally acceptable, at least during the initial phases of site development. Improvements to this segment of W. Marshall Road should occur in Phase 2 or 3 of Plan Area development.

Although not requiring additional capacity improvements, the County will enhance Fink Road between I-5 and Bell Road with an added overlay and striping during Phase 1A to provide a clean, functional south entrance to the CLIBP.

#### ***Off-Site Roadway Requiring Additional Travel Lanes***

The portion of W. Marshall Road from the CLIBP to SR 33 is the only roadway segment adjacent to the site that will be widened to four travel lanes and one center-aligned left-turn lane to accommodate existing and CLIBP-related traffic (see Chapter 3, Figure 3-3). The additional lanes will be needed by the midpoint of Phase 2 development.

#### ***Off-Site Signals***

As shown in Figure 4-3, non-signalized intersections adjacent to or near the Plan Area, including the intersections at the proposed CLIBP entrances on W. Marshall Road and Fink Road, will need to be signalized or reconfigured to include a roundabout to accommodate existing and CLIBP-related traffic. The following intersections are expected to satisfy peak hour signal warrants, meaning that they will need to be signalized or reconfigured to support peak-hour traffic demand. Four of these locations, intersections 1, 7, 8, and 9, are the highest priority and will be needed during the end of Phase 1 or at the beginning of Phase 2 development.

1. Sperry Avenue at SR 33
2. Carpenter Road at W. Main Avenue
3. Crows Landing Road at W. Main Avenue
4. W. Marshall Road at Ward Avenue
5. W. Marshall Road at SR 33
6. W. Marshall Road at CLIBP entrance
7. W. Ike Crow Road at SR 33
8. Fink Road at Bell Road
9. Fink Road at CLIBP entrance

10. Crows Landing Road at E. Marshall Road
11. Fink Road at SR 33

### ***Fink Road/I-5 Interchange Improvements***

The Fink Road/I-5 interchange is less likely to be used than other travel routes by CLIBP employees because I-5 does not provide direct access to some of the communities in which employees are likely to reside, such as Newman, Gustine, and the SR 99 corridor cities in Stanislaus County. However, the interchange will be an important link for trucks traveling to and from the CLIBP.

Improvements to the Fink Road/I-5 interchange will include:

- Signalizing Fink Road at I-5 northbound ramps by Phase 1B; and
- Widening the roadway beneath the freeway to create a westbound left-turn lane at the southbound ramps intersection by Phase 1B.

### ***City of Patterson Impacts***

Two intersections in the City of Patterson will have unacceptable levels of service under existing plus project conditions:

- Sperry Avenue at the I-5 southbound ramps, which is part of interchange improvement being planned as a joint City/County/State project.
- Ward Avenue and Sperry Avenue will have a level of service of F in the am and pm peaks times; however, construction of the South County Corridor (the precise alignment of which is to be determined) should provide some traffic relief to Patterson streets, including Sperry Avenue.

### **4.2.3 2035 Regional Growth and CLIBP-Triggered Off-Site Improvements**

Additional off-site intersection and roadway improvements will be required to accommodate regional growth-and/or CLIBP-related traffic, such as the widening of roadway sections and additional traffic signals. A traffic impact fee will be established based on the traffic analysis and projections in the Transportation Plan to determine the fair share contribution required from CLIBP tenants/leaseholders/contractors for off-site improvements. Other future off-site projects that are not part of the CLIBP but benefit from proposed off-site transportation improvements will also be required to reimburse the County for their proportionate share of the cost. The specific methodology, timing of payment, and other details related to fair share cost allocation for such transportation improvements will be determined by the County separately from this Specific Plan according to the requirements of California's Mitigation Fee Act (California Government Code sections 66000 *et seq.*). This state law sets forth the procedural requirements for establishing and collecting development impact fees and requires public agencies imposing a fee to demonstrate a reasonable relationship, or nexus, between the fee and the purpose for which the fee is collected. This nexus is typically established through a study (in this case, a road impact mitigation fee nexus study) that establishes the extent to which future developments benefit from the off-site roadway improvements needed to serve the Plan area.

### ***Off-Site Roadway Widening and Signal Requirements to Accommodate 2035 Regional Growth***

Sections of two roadways will require widening to accommodate anticipated regional growth.

- W. Main Avenue/E. Las Palmas Ave. - S. Carpenter Road to SR 33
- I-5 north of Sperry Avenue requires widening to six lanes.

Four intersections will meet signal warrants during one or more peak hour periods:

1. Olive Avenue/SR 33
2. Ward Avenue/SR 33
3. I-5 SB Ramps/Sperry Avenue
4. I-5 NB Ramps/Sperry Avenue

***Off-Site Roadway Widening and Signal Requirements to Accommodate 2035 Regional Growth Plus CLIBP Project***

Sections of three roadways, not previously identified will require widening to accommodate anticipated regional growth- and CLIBP-related traffic.

- **SR 33 – Sperry Avenue to Marshall Road.** The portion of SR 33 between Sperry Avenue in the City of Patterson and Marshall Road will be widened to accommodate Phase 2 CLIBP development and regional traffic conditions in 2035. The ideal width in this section would be 78 feet of pavement including four travel lanes, an approximately 14-foot median or center-aligned left-turn lane, and two 8-foot shoulders. This corresponds to SCDPW 110 FT Minor Arterial roadway standard (Plate 3-A15). The County may consider intermittent spot improvements (e.g., adding center left turn lanes at existing public intersections) during Phases 2 and 3 of CLIBP development to enhance capacity and safety.
- **SR 33 – Stuhr Road to Fink Road.** The portion of SR 33 through Newman may be restricted to an ultimate width of three lanes. However, if a three-lane road section were extended north to Stuhr Road, with signalization and other intersection improvements at Stuhr Road, these improvements could potentially supply adequate capacity. Traffic resulting from completion of CLIBP Phase 3 development combined with regional traffic conditions in 2035 will exceed this roadway segment’s two-lane capacity and will require widening to three lanes.
- **I-5 Between Fink Road and Sperry Avenue** requires widening from four to six lanes by completion of CLIBP Phase 3 development combined with regional traffic conditions in 2035.

Four additional intersections, not previously identified, will meet signal warrants during one or more peak hour periods:

1. Fink Road/Davis Road
2. Fink Road/Ward Avenue
3. I-5 NB Ramps/Fink Road
4. I-5 SB Ramps/Fink Road

***Fink Road Interchange Improvements***

- Signalizing the southbound ramp intersection by the completion of the 30-year CLIBP build-out timeframe.

***City of Patterson Impacts***

Under cumulative conditions, one signalized intersection will have unacceptable levels of service without the project. No intersection in the City of Patterson will degrade to unacceptable conditions when CLIBP traffic is included in the cumulative traffic. The intersection with unacceptable conditions without the project occurs at:



- Ward Avenue and Sperry Avenue (also cited as a problem under near term plus project conditions). The level of service at this intersection fails even without CLIBP. Development of the South County Corridor, an expressway linking SR 99 and I-5 immediately north of Patterson, should improve the level of service associated with the intersection. The portion of Ward Avenue in the unincorporated county will not require widening beyond two lanes. Within the Patterson city limits, Ward Avenue, between Las Palmas and Sperry Avenues, can currently accommodate four lanes. South of Las Palmas Avenue, the existing curb to curb width can accommodate a three-lane cross section. No additional widening should be required due to the Project.
- With regard to specific intersections:
  - I-5 and Sperry Road is being planned for signalization; the Transportation Infrastructure Plan (TIP) identifies the Project fair share;
  - Ward Avenue and Sperry Avenue have no feasible mitigation due to the presence of residential development in the southeast quadrant. The TIP indicates that the future South County Corridor (not accounted for in the analysis) will likely relieve Sperry Avenue congestion;
  - Ward Avenue and Las Palmas Avenue was recently improved and has no level of service issues under cumulative traffic conditions;
  - Sperry Avenue and State Route 33 will require signalization; the Project fair share is indicated in the TIP; and
  - Sperry Avenue and Rogers Road has no level of service issues.

#### ***City of Newman Impacts***

The City of Newman 2030 General Plan (adopted in 2007) traffic report (Table 6) and the Northwest Newman Master Plan (April 29, 2014 Traffic Impact Study) indicates that traffic within the City SR 33 will average 36,000 vehicles per day (vpd) at buildout. The General Plan indicates that within the City SR 33 will eventually be widened to four lanes. With 8,200 vpd existing, SR 33 will grow by 27,800 vpd. Traffic from Specific Plan will contribute to all four of the new traffic signals. At the busiest location along SR 33, the Specific Plan will contribute approximately 7,700 vehicles per day (vpd).

Based on an analysis of traffic studies for the Newman General Plan and the Northwest Newman Master Plan, it is expected that future traffic signals in the SR 33 corridor in and near Newman will include intersections at Stuhr Road, Jensen Road, Yolo Street, and Inyo Street. The General Plan indicates that SR 33 will eventually be widened to four lanes. There are not likely to be any intersections needing improvements between Fink Road and Stuhr Road.

All four of the signals may not be warranted for many years. However, about 28 percent of the future traffic will be related to buildout. As noted, one half of these trips are generated locally from homes or businesses. For this reason, the Specific Plan's fair share of these impacts is about 14 percent.

- Inyo Street is one of the four locations along SR 33 identified as likely to meet traffic signal warrants as a result of growth in traffic. When the General Plan traffic studies were conducted, Inyo Street at SR 33 appeared to be the most congested downtown intersection on SR 33. Therefore, it is likely that it may be the first to meet signal warrants. When these and other SR 33 intersections meet signal warrants, the 14 percent fair share described above would be a reasonable contribution from the Specific Plan.

- SR 33 – South of Stuhr Road north of Newman. This section of roadway will exceed two-lane capacity by the end of Phase 3 when combined with 2035 growth traffic. SR 33 through Newman is projected in its General Plan to have an ultimate width of four lanes south of Stuhr Road in and north of the existing city limits.

#### Fair Share Analysis - Segments

No.	Roadway Improvements (lanes)	Existing (A)	2035 + P (B)	Project (C)	D = (C) / (B-A)	LOS Before	LOS After
12	Marshall Rd - SR 33 to Entrance (4)	656	32,663	31,336	98%	E	D
9	Ike Crow Rd - SR 33 to Bell Rd (2)	27	2,865	2,842	100%	B	B
10	Bell Rd - Ike Crow to Fink Rd (2)	50	6,806	6,762	100%	B	B
13	Marshall Rd - Ward to Entrance (2)	641	5,006	3,697	85%	B	B
8	SR 33 - Marshal Rd to Sperry (4)	4,161	25,030	14,733	71%	F	D
4	SR 33 - Stuhr Road to Newman (4)	8,200	36,000	7,700	28%	E	D
16	W. Main - West of Carpenter (4)	7,342	22,318	1,122	7%	E	B
F1	I-5 - North of Sperry Road (6)	40,000	71,690	1,322	4%	E	B
F2	I-5 - Fink Rd to Sperry Ave (6)	38,000	69,628	2,745	9%	E	B

Source: TJKM 2018

Based on estimated traffic volumes from land uses proposed in the Specific Plan, the Plan will constitute 30 percent of the growth in vpd. Projections of future traffic volumes and patterns in the TIP assume that a major portion of the trips will be current and future residents of Newman who will be employed within the Specific Plan Area.

If the traffic is split 50-50 to account for one trip end in Newman and one trip end in the Specific Plan Area, a reasonable fair share for the Specific Plan is approximately 15 percent. This information will need to be considered in determining the final cost sharing procedures for the Specific Plan. Business-to-business interactions between Newman and CLIBP are likely to form the balance of the traffic demand in the corridor.

#### 4.2.4 Transportation Demand Management

Transportation Demand Management (TDM) is a term referring to strategies to influence or encourage changes to travel behavior that result in more efficient use of land and transportation resources. A TDM program for CLIBP will be organized to provide employees with safe and convenient travel options to commute to work that will serve as an alternative to the use of single-occupant vehicles, particularly during peak travel times; as well as, and that will promote the health and environmental benefits of more sustainable transportation modes such as walking, biking, and transit use. Business participation in the TDM program will be mandatory and require the following elements to benefit employees, tenants, CLIBP, and the surrounding community.

Stanislaus County, in consultation with StanCOG, Stanislaus Regional Transit, the cities in Stanislaus County, and private sector business organizations to prepare a TDM plan that identifies public and private entities responsible for implementing the plan and specific TDM strategies, and tracking achievement of the plan's objectives. Among the elements of a TDM plan and implementation will be:

- A comprehensive strategy for reducing solo occupant vehicle travel by employees, business vehicles, and visitors.
- Mandatory participation by all companies within the CLIBP, with a responsible point person assigned to represent CLIBP and coordinate with individual businesses.
- A designated TDM representative from each individual business.
- Annual mandatory employee surveys, with a required response of 90 percent of employees. Surveys will identify, at a minimum, mode and time of travel by employees.
- An annual report indicating status of compliance with TDM goals, established by the County.
- Individual companies and the CLIBP TDM organization shall consider the following measures to achieve compliance with TDM goals:
  - Encourage employees to use flex time;
  - Carpool matching programs;
  - Preferred parking for carpoolers;
  - Van pool programs;
  - On-site facilities, such as breakrooms and shower facilities;
  - Employer sponsor shuttles from Turlock and Modesto;
  - On-site secure bicycle racks;
  - Bike share program for employee use at lunchtime; and
  - Other measures

#### **4.2.5 Transportation Goal**

The following goals apply to the transportation plan and improvements for CLIBP:

- TG 1: Provide primary on-site (“backbone”) roadways and make off-site roadway improvements sufficient to serve the projected growth and build-out of the CLIBP Plan Area, and coordinate with Caltrans and the Federal Highway Administration on any roadway or interchange improvements to state or federal highways required by development at the CLIBP.
- TG 2: Establish and require businesses within CLIBP to participate in a TDM program designed to: reduce the stress of commuting and travel congestion on the County’s roadways; support alternative modes of travel that also enhance the health and well-being of employees; conserve energy and natural resources; and enhance community livability by reducing the pollution and greenhouse gas emissions resulting from single-occupant vehicle use.

#### **4.2.6 Transportation Policies**

The following policies apply to the transportation plan and improvements for CLIBP:

- TP 1: The construction of on-site backbone roads identified as part of Phase 1 is anticipated to start in the portion of the site between southern CLIBP entrance on Fink Road to the DMC, and construction will expand northward as needed during Plan Area build-out.

- TP 2: Two-lane roads listed in Sections 4.2.2 will be rehabilitated to accommodate CLIBP-related traffic and maintain acceptable traffic service levels.
- TP 3: Fink Road, W. Ike Crow Road, and Bell Road will be initially rehabilitated with an overlay and striping.
- TP 4: Traffic levels of service shall be monitored and improvements shall be implemented prior to deterioration below applicable jurisdictional standards identified in the Stanislaus County General Plan, Circulation Element.
- TP 5: Traffic signals will be installed at specified intersections in a timely manner to avoid deterioration of intersection service levels, beginning with the four high-priority locations identified in Section 4.2.2.
- TP 6: The County shall work with Caltrans and any other applicable agencies to implement improvements to the Fink Road/I-5 interchange to support CLIBP-related truck traffic, according to the phasing of truck-intensive land uses within the Plan Area.
- TP 7: Provisions for trucks shall be incorporated into the design of designated truck routes.
- TP 8: A signage system shall be established to direct trucks to the designated truck routes.
- TP 9: Interior roads shall be constructed to accommodate the flow of trucks and peak employee traffic. Interior roadway alignments shall be determined as development plans for specific building sites are submitted for approval.
- TP 10: Equitable methods shall be established to distribute fair share costs associated with constructing off-site transportation improvements required as a result of regional growth- and CLIBP-related land uses.
- TP 11: A Transportation Demand Management Program shall be implemented for CLIBP that includes measures for mandatory participation by all businesses; annual monitoring for compliance with TDM goals; commute and travel options to, from, and at work; incentives for carpooling, transit use, and bicycling; promotion of flexible work schedules; and other measures.

### 4.3 WATER SUPPLY AND DISTRIBUTION

The Plan Area is located within the Del Puerto Water District, which provides agricultural water supplies and incidental municipal and industrial water deliveries. The majority of the area surrounding the Plan Area relies heavily upon groundwater for agricultural and urban uses, both potable and non-potable. Four active wells are on the CLIBP project site.

As described in greater detail in the *Crows Landing Industrial Business Park Water Supply (Potable & Non-Potable) Infrastructure and Facilities Study* (Appendix G), referred to herein as the Water Supply Study, both potable and non-potable water will be provided by on-site extraction and treatment of groundwater through the use of existing wells and new public wells. The Water Supply Study includes a Groundwater Resources Impact Assessment. As documented in the Water Supply Study, some decline in local groundwater elevations has occurred due to abnormally low rainfall that resulted in increased groundwater pumping, but more recent studies indicate that groundwater elevations are relatively stable over time. Pursuant to state law and County ordinance, the CLIBP project must demonstrate that the new groundwater pumping facilities will not create an unsustainable extraction of groundwater. The County will establish the site baseline conditions prior to project implementation and develop a groundwater monitoring plan that outlines the monitoring well

network and procedures for the groundwater level monitoring program. The extent and frequency of monitoring will be evaluated every five years. Groundwater extracted from new wells will be treated at the wellheads for potable use. Fluctuations in surface water deliveries and the lack of existing entitlements or rights makes the use of surface water infeasible; however, a conjunctive use strategy that incorporates surface water to augment groundwater sources may be considered in the future.

Analyses performed as part of the Water Supply Study indicate that existing wells will be capable of supporting groundwater extraction for non-potable use at their historical annual extraction volumes of 834 acre feet /year (AFY) when pumped year round. If the existing wells fail to supply the assumed volumes, the water supply volume would be supplemented as needed through the installation of new wells of similar construction. Any non-potable water demand in excess of 834 AFY will be supplied using new, on-site shallow aquifer wells. Optimal locations for the new shallow aquifer wells will be selected based on performance of the existing wells, groundwater level monitoring data developed during CLIBP operation, and additional water supply development studies, as needed. Other components of the water supply strategy, including ensuring sustainable groundwater yield, include:

- Shallow groundwater demand in excess of the historical average shallow aquifer extraction rate – 183 AFY at Phase 2 build-out and 489 AFY at Phase 3 build-out – will be offset by an equivalent volume of increased recharge, such that the net groundwater extraction rate from the shallow aquifer does not increase above historical levels. This increased shallow aquifer recharge will be derived from a combination of the following sources:
  - A stormwater pond along the northeastern boundary of the Plan Area will be constructed to detain runoff from Little Salado Creek and allow for groundwater recharge. (See Section 4.5, “Stormwater Management,” for details about the stormwater pond.)
  - Developers of individual leaseholds (lots) will be required to meet specified net recharge increase/demand reduction (to be determined) through the implementation of a combination of Low Impact Development (LID) standards that promote on-site stormwater detention and recharge and in-lieu recharge derived from non-potable water demand reduction.

LID elements for future development may include features such as on-site detention/infiltration basins, rock wells, permeable pavements, street planters, vegetated swales, drainage area disconnection, and other elements that will not create habitat for potentially hazardous wildlife. (See Appendix B design and development standards for streetscape/landscape guidance.) In lieu recharge may be derived from landscape development using xeriscape techniques. It is anticipated that the CLIBP non-potable water demand can be decreased by an additional 200 AFY through the application of these methods.

The CLIBP potable water supply will be developed as follows:

- New water supply wells will be installed into the aquifer at the approximate locations shown in the Water Supply Study. The potable supply wells will be constructed to pump water from the full usable depth of this aquifer.
- Groundwater extracted from the aquifer for potable use will be treated to meet applicable water quality standards.

CLIBP water demand projections were developed based on the total acreage of developable area within the Plan Area and a total water rate of 2,500 gallons per day/acre (gpd/ac), from the SCDPW. The SCDPW estimates that the potable water necessary to meet CLIBP demand will be 60 percent of the total water demand and the non-potable water demand for fire protection and irrigation uses makes up the remaining 40 percent. The projected average daily demand for the CLIBP at build-out is 2.5 million gpd (1.34 million gpd potable and 1.18 million gpd non-potable), which equates to approximately 1,501 AFY of potable water and 1,322 AFY of non-potable water. Actual demands may vary somewhat from the projections based on factors such as the types of industry developed, density, employees per acre, conservation, or other factors. However, land uses that include intensive water uses are not permitted on site. Non-potable water may be utilized for irrigation and fire protection, which will significantly reduce water treatment costs required to achieve drinking water standards. While providing potential flood and groundwater quality protection, the LID standards incorporated into site development, such as vegetated swales and infiltration planters along roadways, will also promote stormwater detention and on-site irrigation use.

#### 4.3.1 Water System Plan

CLIBP build-out will require approximately 2.71 million gallons (MG) of potable water storage and 0.72 MG of non-potable water storage. Three alternatives were identified to supply water to CLIBP, with each alternative assumed to provide the same supply capacity. Based on these water storage requirements, it is estimated that a total of four water storage tanks (three for potable water and one for non-potable water) will be required in the Plan Area. A water plant at the southeast corner of CLIBP at the juncture of Fink and Bell Roads is common to all three alternatives. Both potable and non-potable water piping systems have been shown for each alternative. Non-potable water may or may not be split out after water is piped to the water plant. A split of non-potable from potable water supplies would occur if water treatment is required for potable water or there is a need by the County for piping facilities to accept non-potable water from other sources (e.g., use of highly treated reclaimed water). Each of the three alternatives also envisions using two or more wells in each phase to:

- ensure reliability in supply (redundancy in the event a well should fail in the first phase or water quality should drop in a well); and
- provide more flexibility during operations to minimize and better control aquifer drawdown if project-related subsidence effects are believed to be occurring.

In addition, compliance with acceptable potable water standards can be very expensive and can sometimes require the use of reverse osmosis (RO) and/or blending to achieve allowable levels.

Section 4.3.2 describes the alternatives for the anticipated development or improvement of infrastructure to facilitate CLIBP build-out as envisioned in three 10-year phases. However, the timing of proposed water system improvements may be subject to change based on the needs of site users and timing/location of proposed on-site development.

#### 4.3.2 Water Supply and Distribution System

The County will explore three alternatives and select a preferred alternative prior to initiation of Phase 1:

- Option 1: extending the Crows Landing Community Services District (CSD) service area to include the CLIBP to enable the development of a shared water system under the CSD's existing drinking water supply permit;

- Option 2: Obtaining a new water supply permit to enable the County to develop a standalone water supply for the CLIBP, or
- Option 3: extending the City of Patterson’s water service area to include the CLIBP under its existing drinking water supply permit.

### Option 1

Under Option 1, the County would combine the water supply at the CLIBP with the water supply from the Crow’s Landing Community Service District (CLCSD) by extending the CLCSD service area along Fink road to include the CLIBP site (Figure 4-4). A combined water supply system would provide the following benefits:

- Provide blended water for improved water quality. Blending the waters from each area could reduce the chemical concentrations of concern associated with each area to produce good quality drinking water and potentially reduce or eliminate the need for treatment. (Refer to the E-PUR Technical Memorandum, CLIBP Water Supply Alternatives for Consideration (October 24, 2017), which is appended to this document as Appendix C of Appendix G, CLIBP Water Supply (Potable & Non-Potable) Infrastructure and Facilities Study.)
- Provide a single, consolidated single water system. A consolidated water system could provide efficiency in administration, operation, and maintenance; enable the County able to obtain state grant funding for water meters more easily; allow for the use of a tiered rate structure to make water more affordable to residential customers; and provide additional reserve funds for capital planning and system maintenance, to minimize service disruptions.

The raw water transmission system and the potable and non-potable water pipe system, wells, and storage tanks associated with Option 1 are illustrated in Figures 4-4 through 4-7 and summarized by phase below.

#### Phase 1

Backbone infrastructure constructed during Phase 1 will include the development of a raw water supply system from two existing wells at the CSD, which would be conveyed through a pipeline to the CLIBP (Figure 4-5). Potable and non-potable water would be delivered to the Fink Road Corridor during Phase 1A and to the airport, southern Public Facilities Area, and Bell Road Corridor during Phase 1B (Figure 4-6).

- Phase 1A: Potable water improvements include a water treatment system plant and potable water storage tank (1.19 MG) and booster pump (BP) station at the corner of Bell Road and Fink Road; two water wells and wellhead treatment system (indicated by red triangles) in the northern part of the Plan Area to supply water to both the potable and non-potable water tanks; and distribution pipes and valves (Figure 4-6). Non-potable water infrastructure improvements include distribution pipes, valves, and fire hydrants, and a non-potable water storage tank (0.72 MG) (Figure 4-7). Two existing wells at the CLCSD would provide additional water, which would be conveyed through a water supply pipeline along Fink Road.
- Phase 1B: Construction of backbone infrastructure for potable water is limited to distribution piping and valves for service to the Bell Road Corridor, airport, and southern Public Facilities Area (Figure

---

4-6). Non-potable water infrastructure improvements include distribution pipes, valves, and fire hydrants (Figure 4-7).<sup>2</sup>

### *Phase 2*

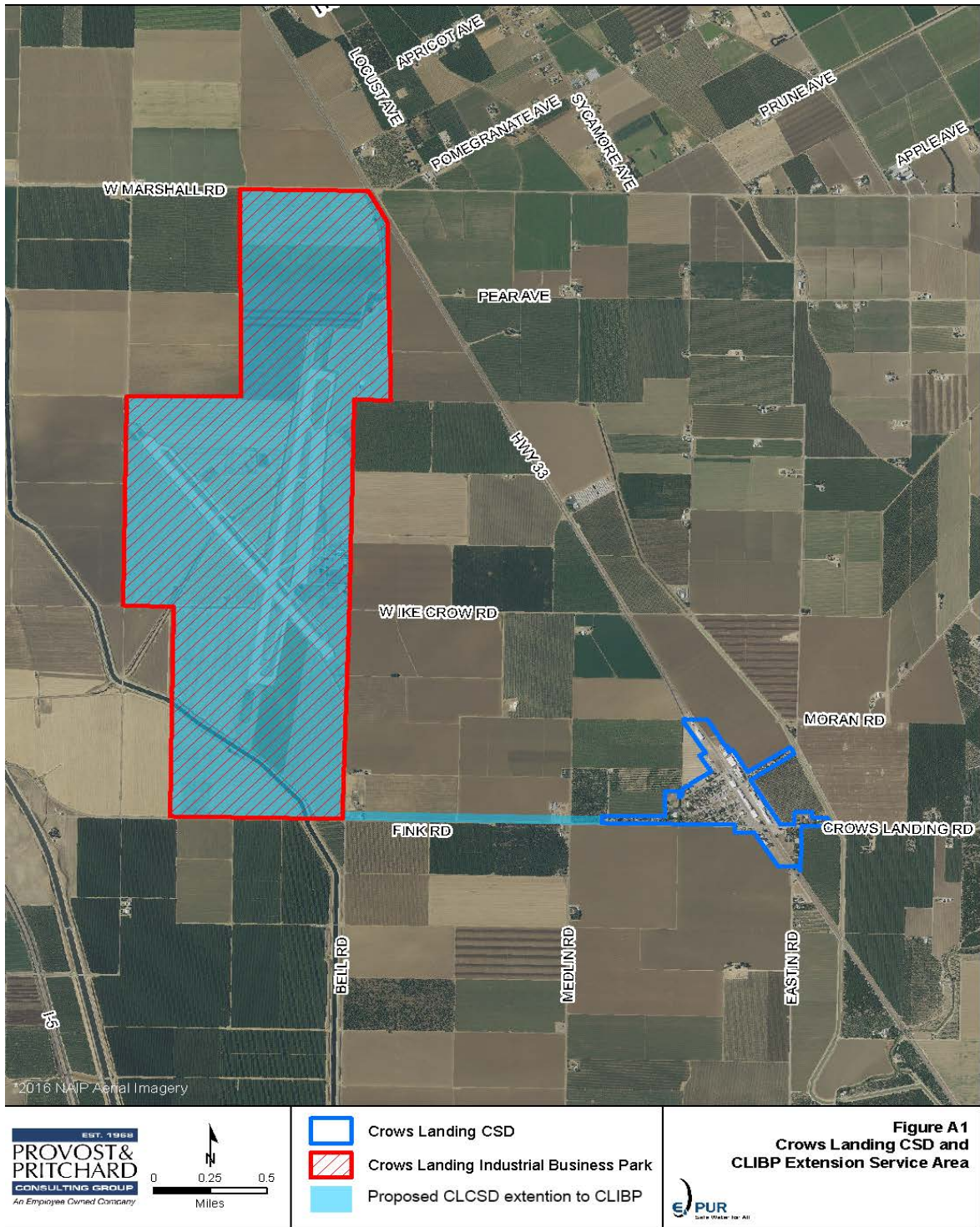
Construction of Phase 2 infrastructure includes the extension of raw water transmission lines from the wells and storage tanks to the raw water transmission lines and water treatment plant installed in Phase 1 (Figure 4-5). Potable water infrastructure includes a potable water storage tank, Tank 2B (1.52 MG), and a BP station at the northern part of the Specific Plan Area, two new water wells and wellhead treatment system (as indicated by the blue triangles) also located in the northern part of the Specific Plan Area to supply water to both the potable and non-potable water systems, and distribution pipes and valves (Figure 4-6). Non-potable water infrastructure required for Phase 2 is primarily limited to distribution pipes, valves, and fire hydrants, with connections to the non-potable water tank and raw water transmission line in Bell Road (Figure 4-7).

### *Phase 3*

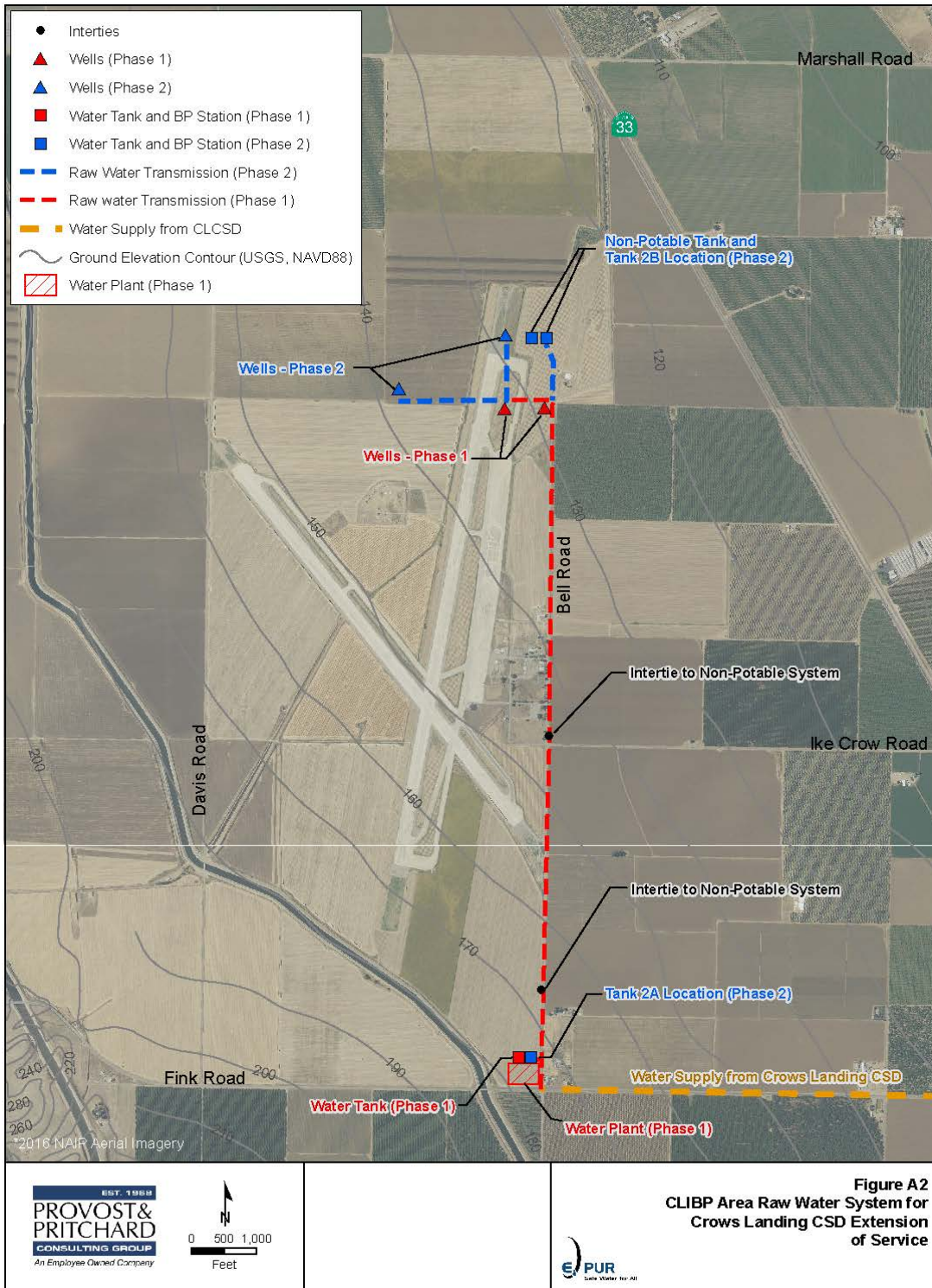
Phase 3 infrastructure improvements for potable water service to the Phase 3 areas south of W. Marshall Road includes distribution pipes and valves (Figure 4-6). Non-potable water infrastructure required for Phase 3 includes distribution pipes, valves, and fire hydrants (Figure 4-7).

<sup>2</sup> Figures 4-6 and 4-7 do not break down Phase 1 into sub-phases “A” and “B.”





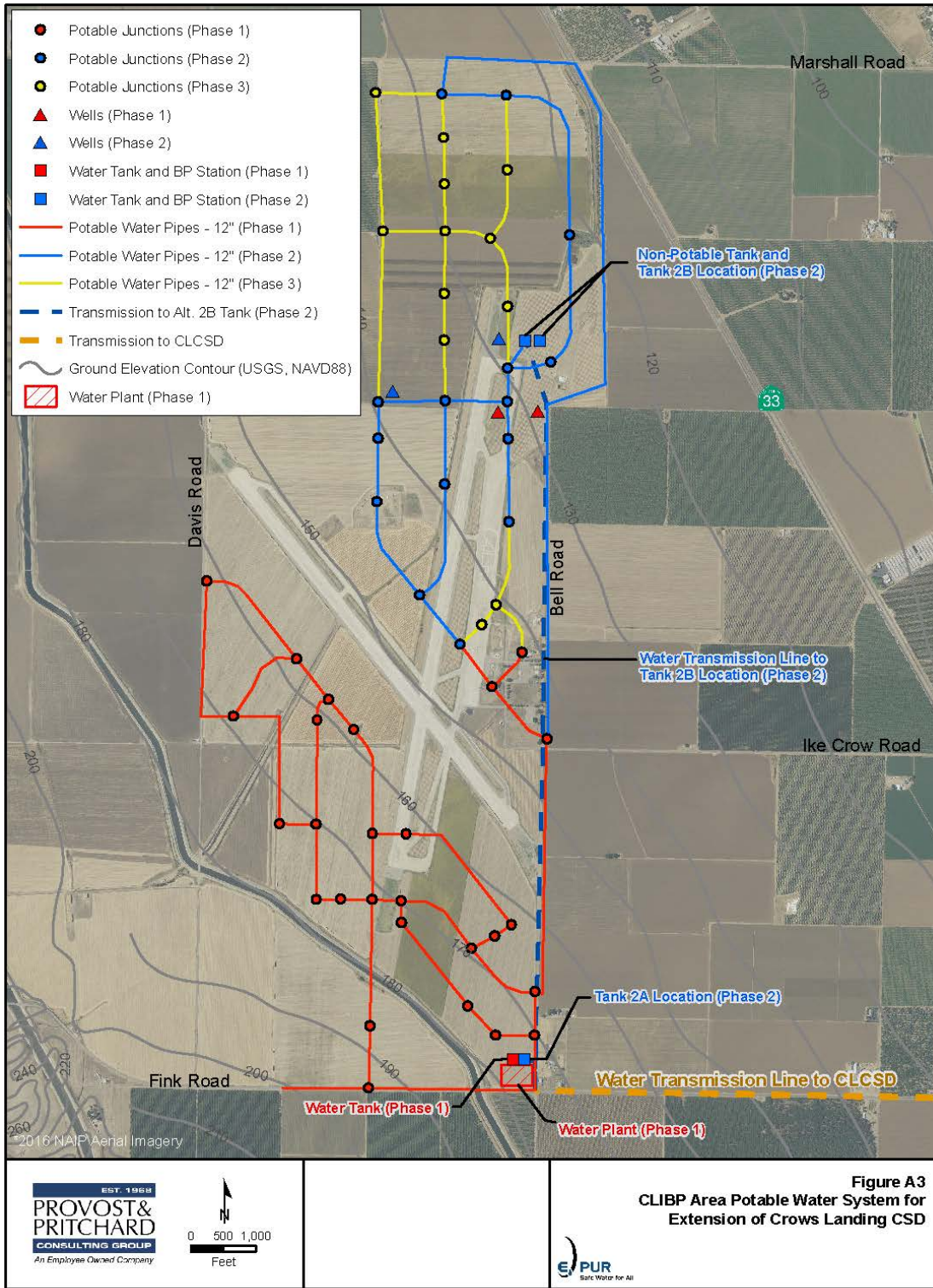
Source: E-PUR, Provost & Pritchard 2017  
 Figure 4-4: Alternative A – Crows Landing CSD Water Supply



10/24/2017 : G:\E-PUR-2563\256317001-Stan Co Crows Landing\GISMap\Facilities\Alternatives\raw\_water\_CLCSD.mxd

Source: E-PUR, Provost & Pritchard 2017  
 Figure 4-5: Alternative A CLIBP Raw Water System

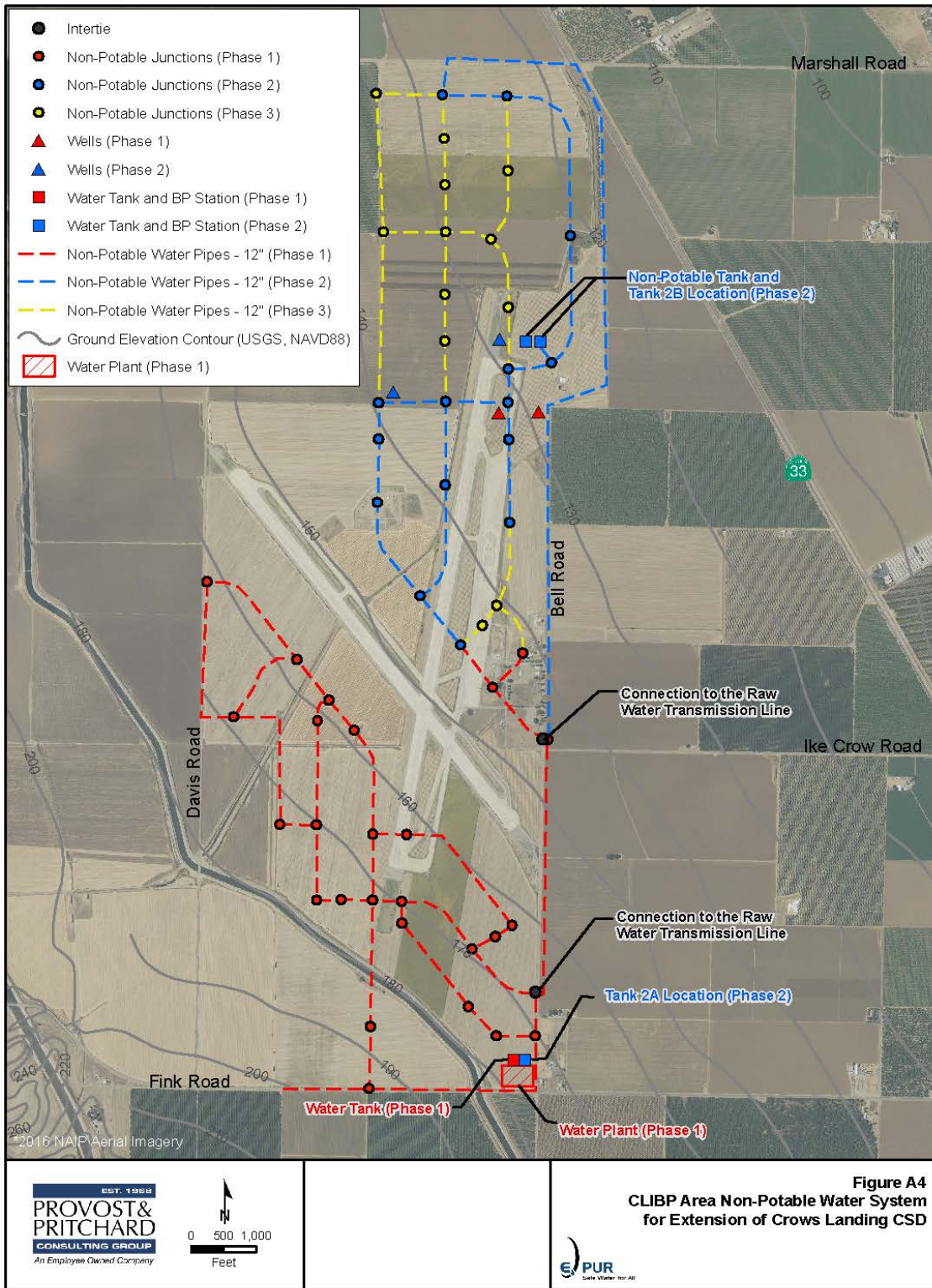
Figure A2  
 CLIBP Area Raw Water System for  
 Crows Landing CSD Extension  
 of Service



10/24/2017 : G:\E-PUR-2563\256317001-Stan Co Crows Landing\GIS\Map\Facilities\Alternatives\potable\_CLCSD v2.mxd

Source: E-PUR, Provost & Pritchard 2017

Figure 4-6: Alternative A CLIBP Potable Water System



10/24/2017 : G:\E-PUR-2563\256317001-Stan Co Crows Landing\GISMap\Facilities\Alternatives\non-potable\_CLCSD.mxd

Source: E-PUR, Provost & Pritchard 2017

Figure 4-7: Alternative A CLIBP Non-Potable Water System

## Option 2

Under Option 2, the County would provide a standalone water supply the CLIBP by undertaking all steps necessary to obtain a new drinking water permit to CLIBP, including the performance of valuations of nearby CLCSD and City of Patterson systems (Figure 4-8). The raw water transmission system and the potable- and non-potable water pipe system, wells, and storage tanks for Alternative B are illustrated in Figures 4-9 through 4-11 and summarized by phase below.

### *Phase 1*

Backbone infrastructure constructed during Phase 1 would include the installation of two new wells and a raw water transmission line that would supply potable and non-potable water tanks and a new water treatment plant near the intersection of Bell Road and Fink Road (Figure 4-9). Potable and non-potable water would be delivered to the Fink Road Corridor during Phase 1A and to the airport, southern Public Facilities Area, and Bell Road Corridor in Phase 1B.

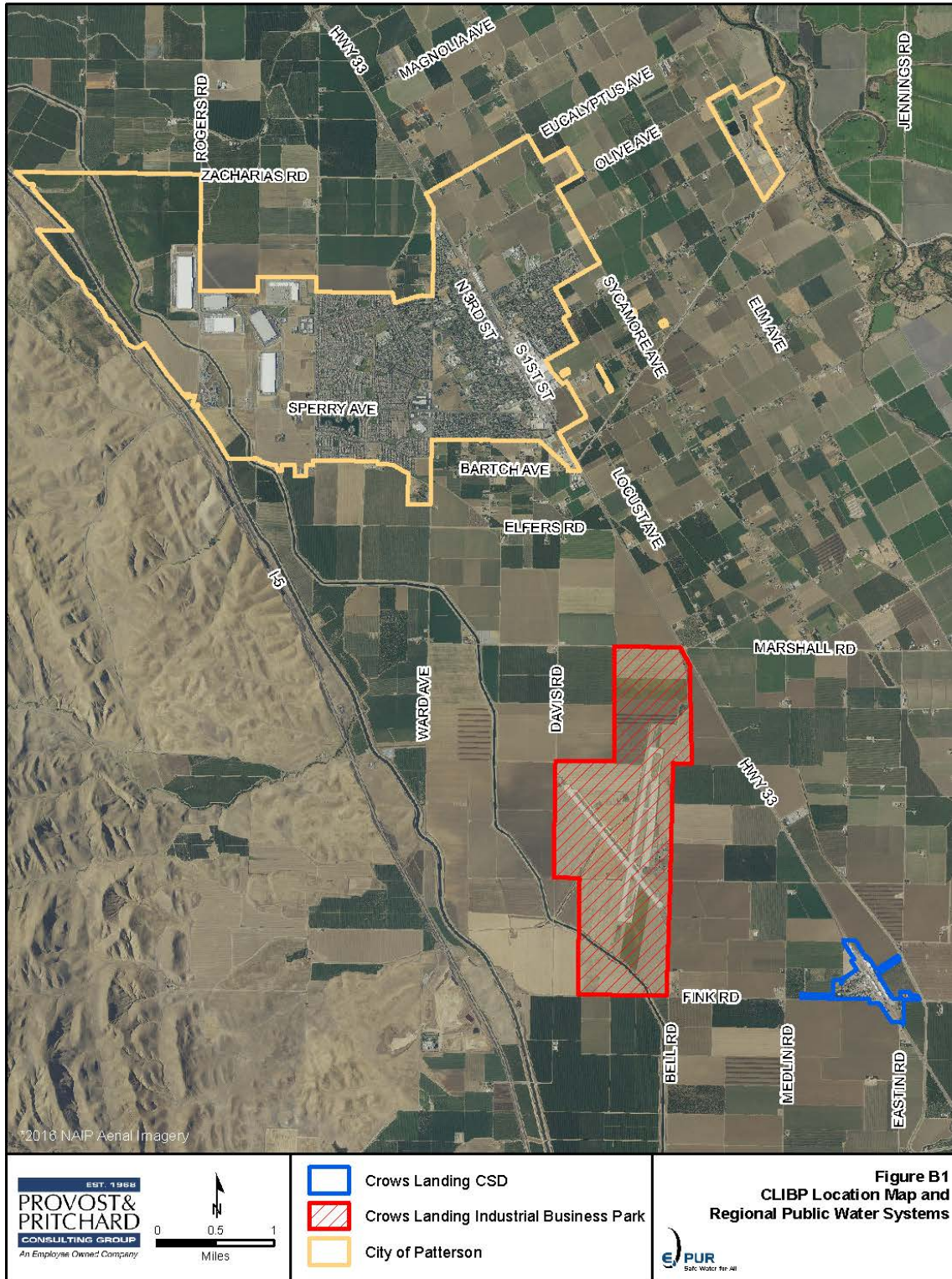
- Phase 1A: Potable water improvements includes a water treatment system plant, potable water storage tank (1.19 MG), and booster pump (BP) station at the corner of Bell Road and Fink Road; two water wells and wellhead treatment system (indicated by red triangles) in the northern part of the Plan Area to supply water to both the potable and non-potable water tanks; and distribution pipes and valves (Figure 4-10). Non-potable water infrastructure improvements include distribution pipes, valves, and a non-potable water storage tank (0.72 MG) (Figure 4-11).
- Phase 1B: Construction of backbone infrastructure for potable water is limited to distribution piping and valves for service to the Bell Road Corridor, airport, and southern Public Facilities Area (Figure 4-10). Non-potable water infrastructure improvements include distribution pipes, valves, and fire hydrants (Figure 4-11).

### *Phase 2*

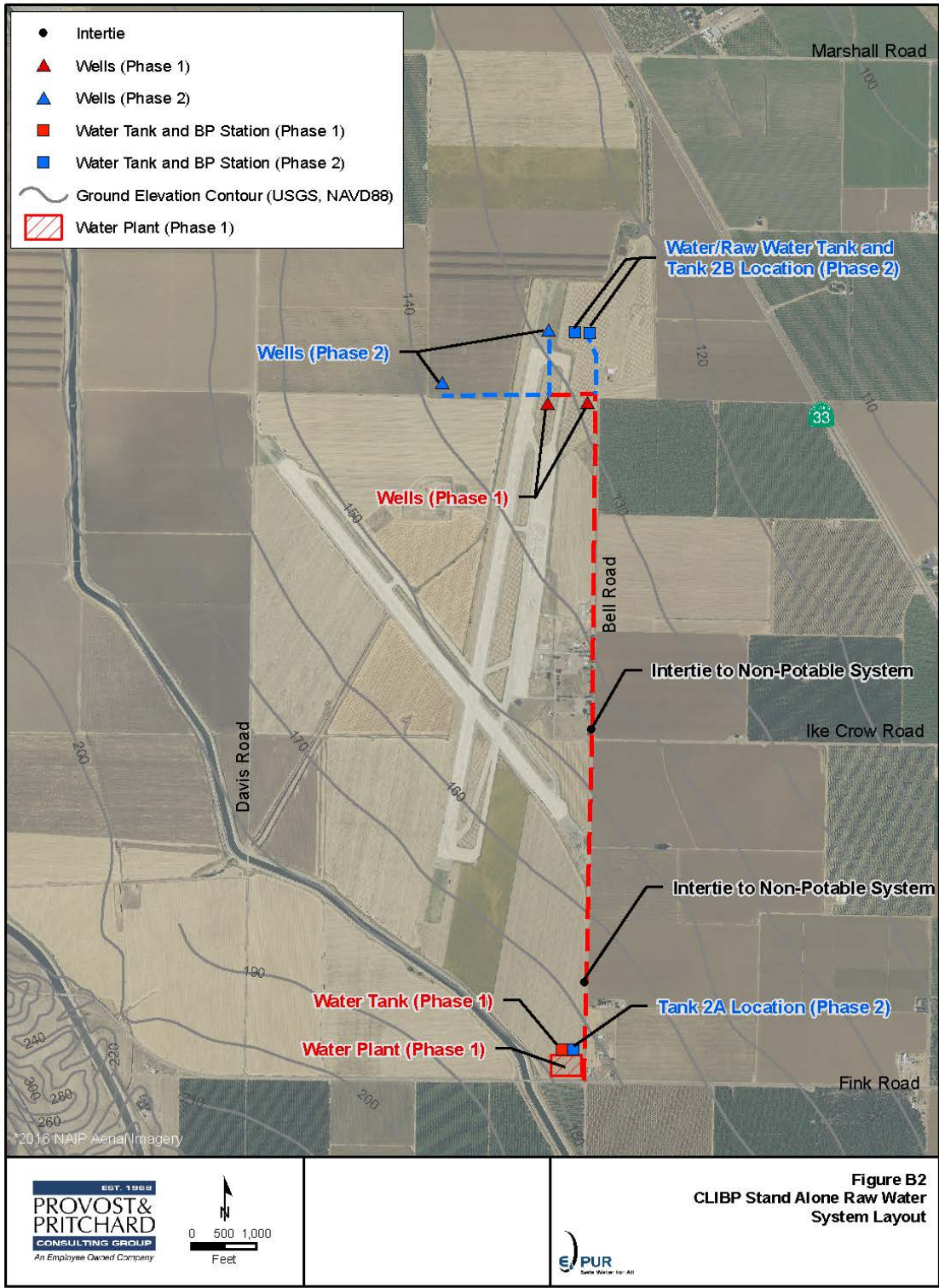
Construction of Phase 2 infrastructure includes the extension of raw water transmission lines from the new wells and storage tanks to the raw water transmission lines and water treatment plant installed during Phase 1 (Figure 4-9). New potable water infrastructure include a potable water storage tank (1.52 MG), Tank 2B, and a BP station at the northern part of the Specific Plan Area, two new water wells and wellhead treatment system (as indicated by the blue triangles) also located in the northern part of the Specific Plan Area, supplying water to both the potable and non-potable water systems, and distribution pipes and valves (Figure 4-10). Non-potable water infrastructure required for Phase 2 is limited primarily to distribution pipes, valves, and fire hydrants, with connections to the non-potable water tank and raw water transmission line in Bell Road (Figure 4-11).

### *Phase 3*

Phase 3 infrastructure improvements for potable water service to the Phase 3 areas south of W. Marshall Road includes distribution pipes and valves (Figure 4-10). Non-potable water infrastructure required for Phase 3 includes distribution pipes, valves, and fire hydrants (Figure 4-11).



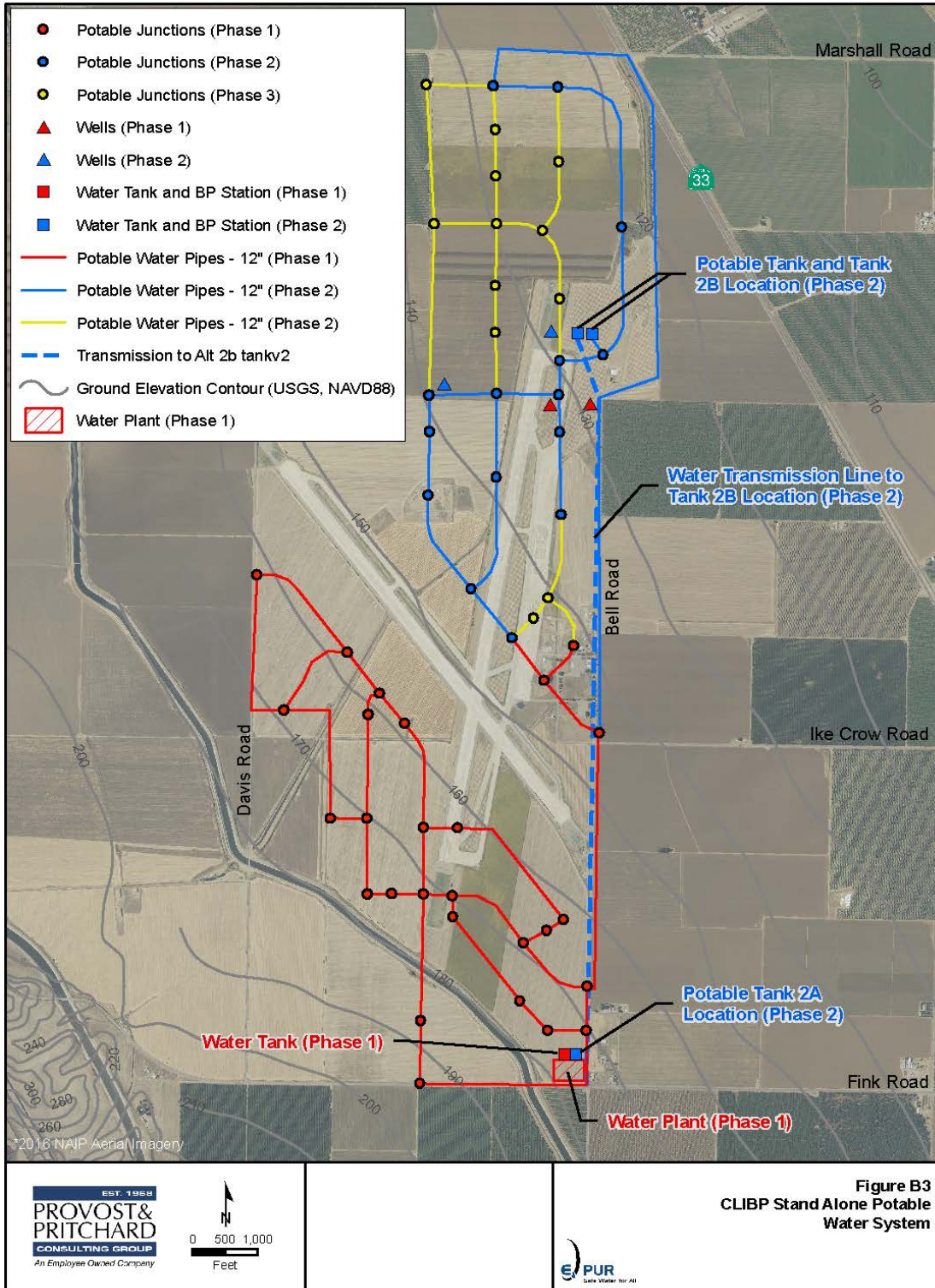
10/23/2017 : G:\E-PUR-2563\256317001-Stan Co Crows Landing\GISMap\Location.mxd  
 Source: E-PUR, Provost & Pritchard 2017  
 Figure 4-8: Alternative B – Stand Alone Water Supply for CLIBP



10/23/2017 : G:\E-PUR-2563\256317001-Stan Co Crows Landing\GISMap\Facilities\Alternatives\raw\_water\_CLIBP.mxd

Source: E-PUR, Provost & Pritchard 2017

Figure 4-9: Alternative B CLIBP Raw Water System

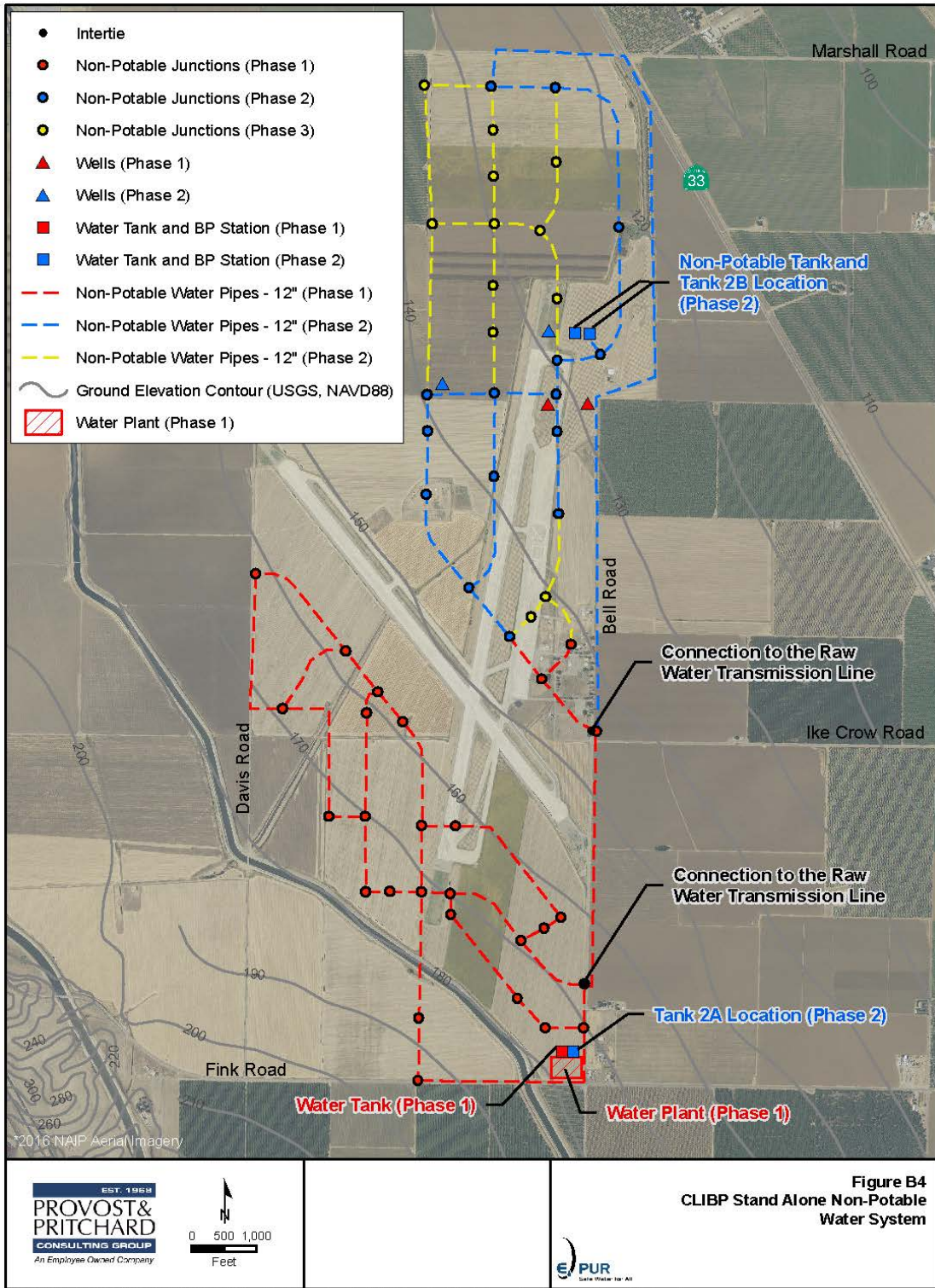


10/23/2017 : G:\E-PUR-2563\256317001-Stan Co Crows Landing\GIS\Map\Facilities\Alternatives\potable\_CLIBP.mxd

Source: E-PUR, Provost & Pritchard 2017

Figure 4-10: Alternative B CLIBP Potable Water System





Source: E-PUR, Provost & Pritchard 2017  
Figure 4-11: Alternative B CLIBP Non-potable Water System

### Option 3

Based on discussion with the City of Patterson, there is inadequate capacity to supply the CLIBP with potable water, and the City's recently updated Water Master Plan does not provide for an extension of water service to the CLIBP. Under Option 3, the County will drill and install a series of groundwater potable water supply wells at the CLIBP to provide the required water supply capacity for the project and install an interconnecting water supply pipeline between the CLIBP and current Patterson service area to provide additional water service reliability (Figure 4-12). The raw water transmission system, potable and non-potable water pipe system, wells, and storage tanks for Alternative C, are illustrated in Figures 4-13 through 4-15 and summarized by phase below.

#### Phase 1

Backbone infrastructure constructed during Phase 1 will include two new wells and a raw water transmission line that will supply water to potable and non-potable water tanks and the water treatment plant proposed near the intersection of Bell Road and Fink Road (Figure 4-13). Potable and non-potable water will be delivered to the Fink Road Corridor during Phase 1A and to the airport, southern Public Facilities Area, and Bell Road Corridor in Phase 1B.

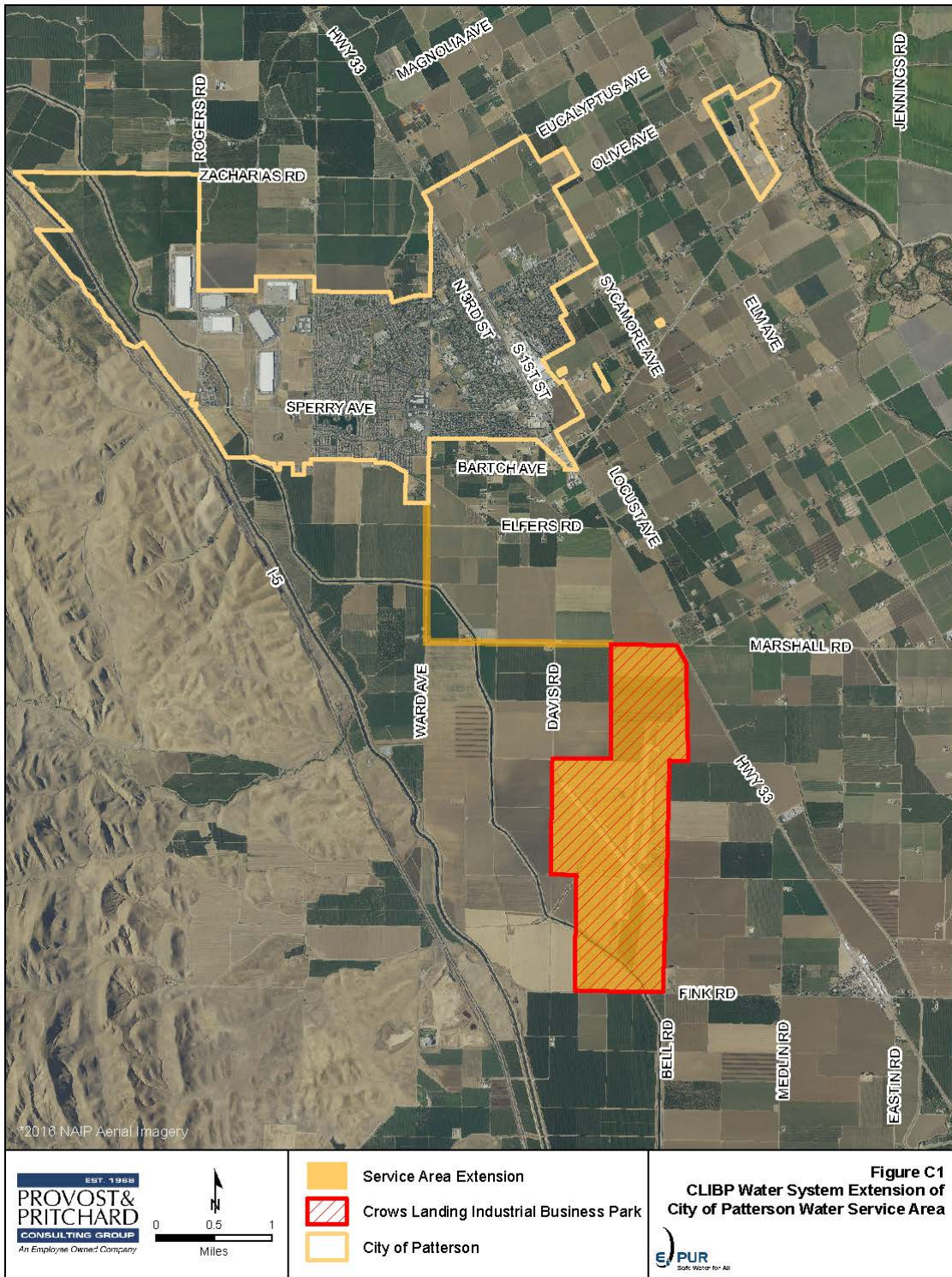
- Phase 1A: Potable water improvements include a water treatment system plant, potable water storage tank (1.19 MG), and booster pump (BP) station at the corner of Bell Road and Fink Road; two water wells and wellhead treatment system (indicated by red triangles) in the northern part of the Plan Area to supply water to both the potable and non-potable water tanks; and distribution pipes and valves (Figure 4-14). Non-potable water infrastructure improvements include distribution pipes, valves, and fire hydrants, and a non-potable water storage tank (0.72 MG) (Figure 4-15).
- Phase 1B: Backbone infrastructure for potable water is limited to distribution piping and valves for service to the Bell Road Corridor, airport, and southern Public Facilities Area (Figure 4-14). Non-potable water infrastructure improvements include distribution pipes, valves, and fire hydrants (Figure 4-15).

#### Phase 2

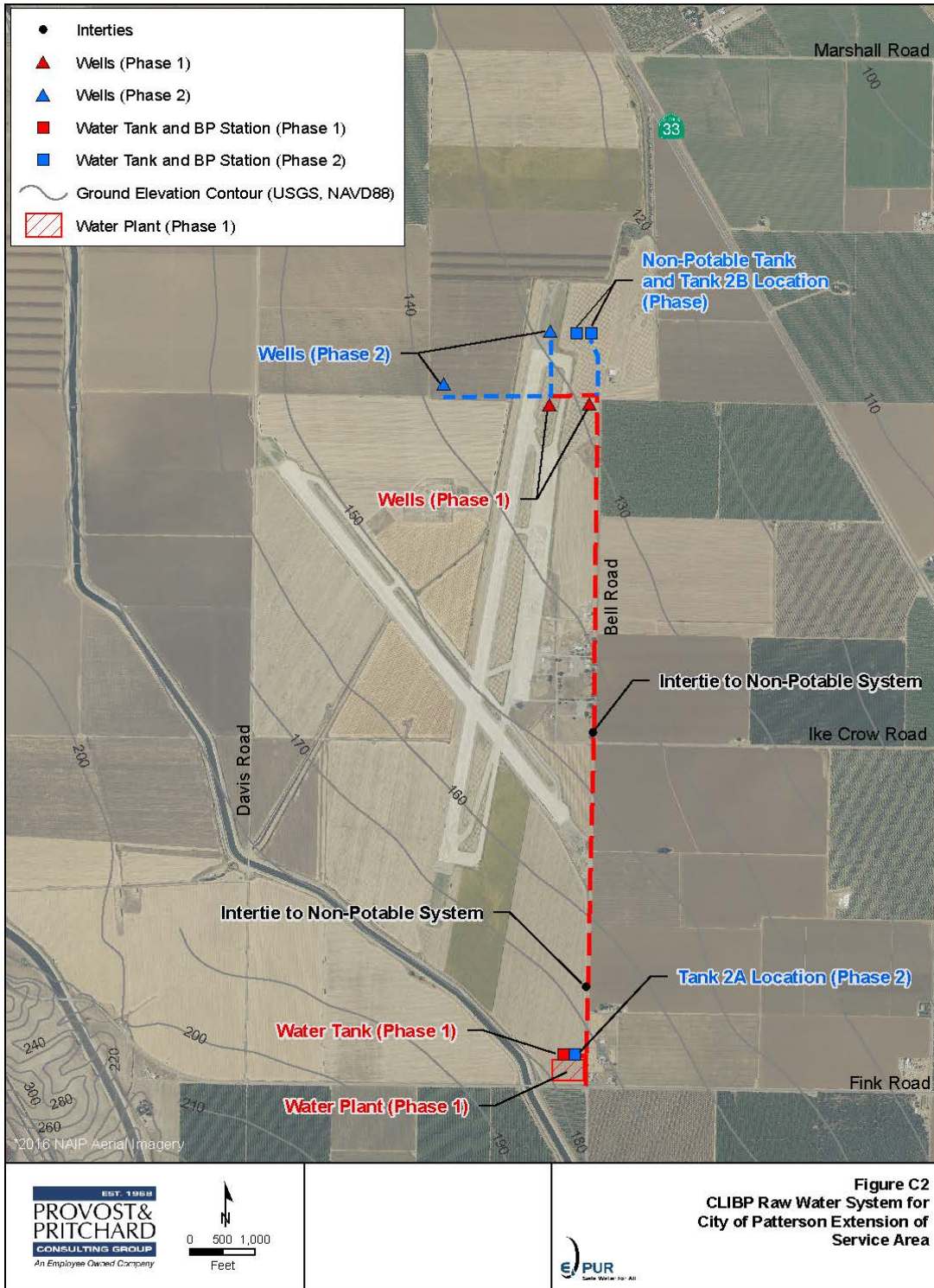
Construction of Phase 2 infrastructure includes the extension of raw water transmission lines from the wells and storage tanks to the raw water transmission lines and water treatment plant installed in Phase 1 (Figure 4-13). Potable water infrastructure includes a potable water storage tank (1.52 MG), Tank 2B, and a BP station at the northern part of the Specific Plan Area; two new water wells and wellhead treatment system (as indicated by the blue triangles) also located in the northern part of the Specific Plan Area, supplying water to both the potable and non-potable water systems; and distribution pipes and valves (Figure 4-14). Non-potable water infrastructure required for Phase 2 is primarily limited to distribution pipes, valves, and fire hydrants, with connections to the non-potable water tank and raw water transmission line in Bell Road (Figure 4-15). Additional water supply would come from the City of Patterson and conveyed through a water supply pipeline located along Marshall Road and Ward Avenue.

#### Phase 3

Phase 3 infrastructure improvements for potable water service to the Phase 3 areas south of W. Marshall Road includes distribution pipes and valves (Figure 4-14). Non-potable water infrastructure required for Phase 3 includes distribution pipes, valves, and fire hydrants (Figure 4-15).



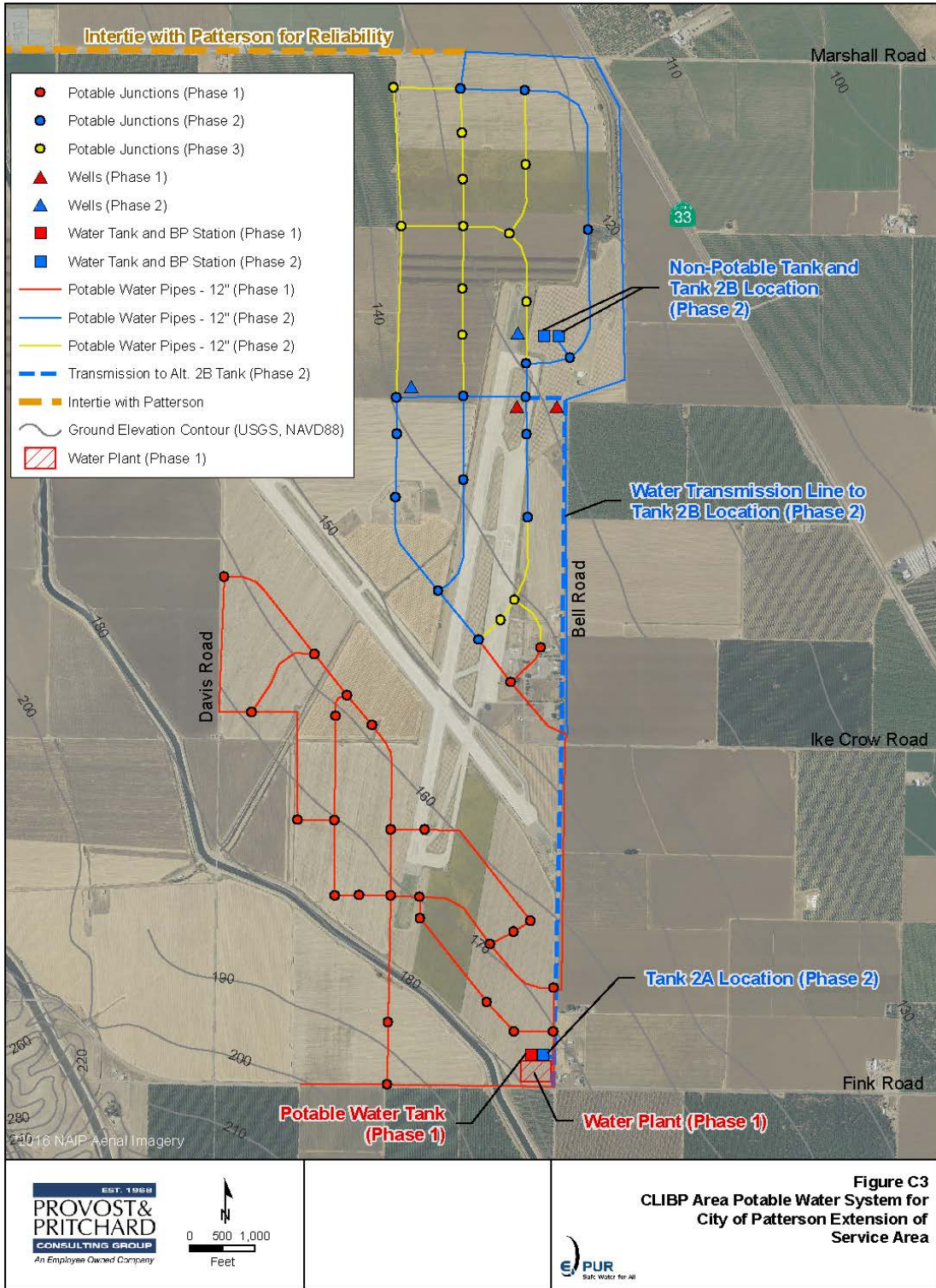
Source: E-PUR, Provost & Pritchard 2017  
 Figure 4-12: Alternative C – Extension to CLIBP from the City of Patterson



10/20/2017 : G:\E-PUR-2563\256317001-Stan Co Crows Landing\GISMap\Facilities\Alternatives\raw\_water\_Patterson.mxd

Source: E-PUR, Provost & Pritchard 2017

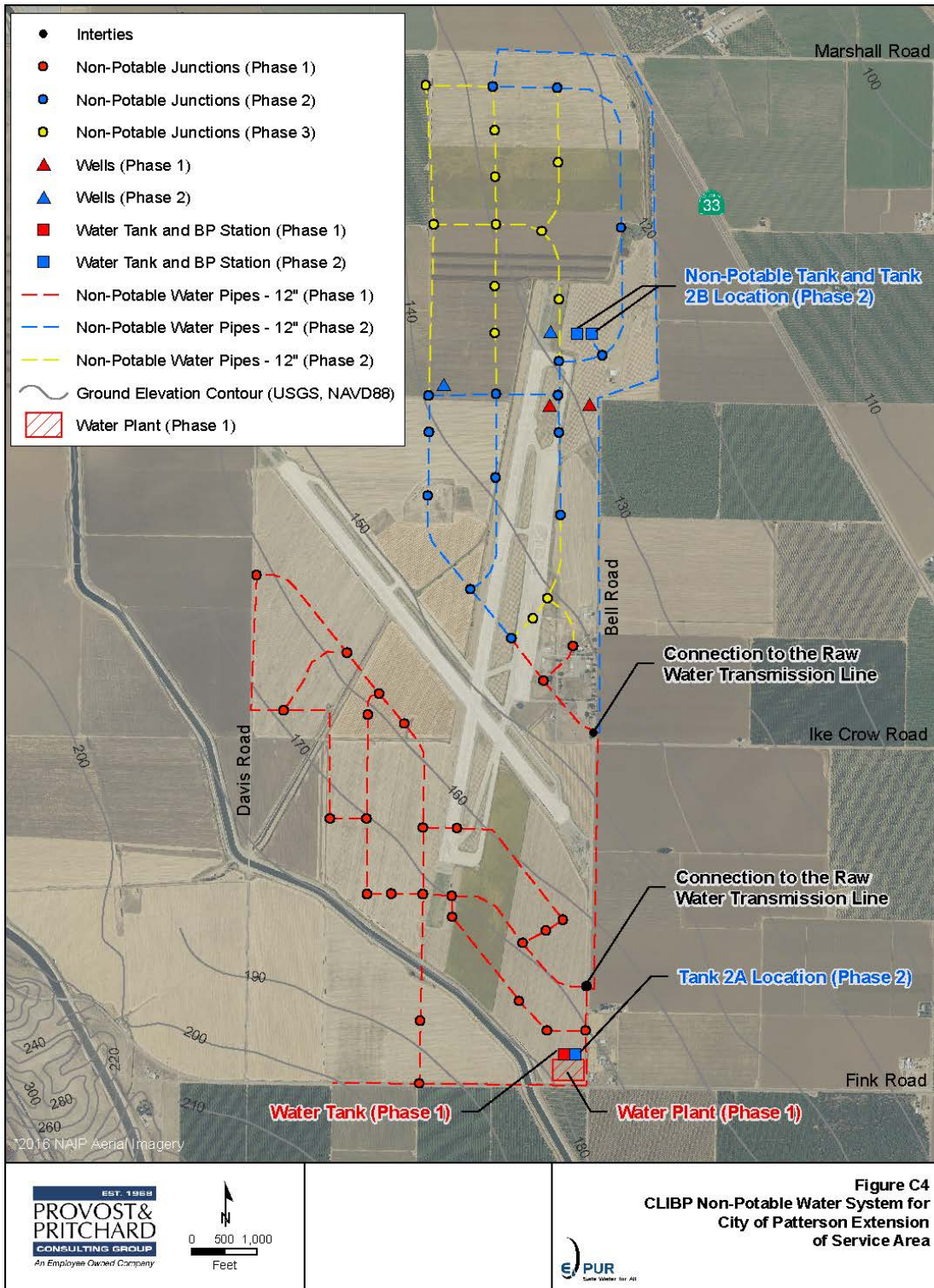
Figure 4-13: Alternative C CLIBP Raw Water System



10/20/2017 : G:\E-PUR-2563\256317001-Stan Co Crows Landing\GIS\Map\Facilities\Alternative\spotable\_Patterson.mxd

Source: E-PUR, Provost & Pritchard 2017

Figure 4-14: Alternative C CLIBP Potable Water System



10/20/2017 : G:\E-PUR-2563\256317001-Stan Co Crows Landing\GIS\Map\Facilities\Alternative\snon-potable\_Patterson.mxd

Source: E-PUR, Provost & Pritchard 2017

Figure 4-15: Alternative C CLIBP Non-Potable Water System

### 4.3.3 Water System Goals

The following goals apply to CLIBP on-site water supply and distribution system improvements:

- WG 1: Provide a water supply and distribution system that is sufficient to serve the projected build-out of the CLIBP Plan Area; if feasible, does not rely on water supply from other providers; and results in sustainable groundwater extraction.
- WG 2: Identify baseline conditions and develop a groundwater-monitoring plan prior to CLIBP project implementation.

### 4.3.4 Water System Policies

The following policies apply to CLIBP on-site water supply and distribution system improvements:

- WP 1: Initial water system infrastructure shall be constructed to provide water supply to the Fink Road Corridor and extends to the Bell Road Corridor, airport, and southern portion of the Public Facilities Area.
- WP 2: Water conservation shall be encouraged in industrial processes by making reclaimed wastewater available for cooling and other industrial use in the Plan Area.
- WP 3: Water conservation methods shall be incorporated into site and streetscape landscaping. Potable water will be restricted from use in site landscaping and streetscape landscaping.
- WP 4: Groundwater for potable and non-potable use shall result in a sustainable yield through both water conservation and groundwater recharge measures, such as:
- Compliance with state and County conservation requirements for potable water use;
  - Requirement for climate-appropriate landscaping in both the public and private realms that reduces applied water to the greatest extent feasible once plants are established; and
  - Construction of naturalized stormwater management systems (e.g., natural swales, improved/restored creekways, and detention areas) that maximize opportunities for groundwater recharge without creating potential wildlife hazards to aircraft operations.
- WP 5: Placement and design of above ground water systems (such as tanks and water plant) shall enhance the overall project design through use of setbacks and landscaping to scale the systems with surrounding development.

#### 4.4 WASTEWATER COLLECTION AND TREATMENT

Although remnants of a sewage storage and treatment system are located within the CLIBP Plan Area, the system is inadequate for Plan Area wastewater collection and treatment. The County's preferred strategy is for the CLIBP to connect to the Western Hills Water District (WHWD) sanitary sewer effluent conveyance system, which will transport CLIBP effluent to the City of Patterson's wastewater conveyance system for treatment at the City of Patterson Water Quality Control Facility (WQCF).

##### 4.4.1 Wastewater Collection System Plan

Although the Specific Plan proposes to transport CLIBP effluent to the City of Patterson's wastewater conveyance system for treatment, in the event that the County determines this option is infeasible, the County will develop a plan to provide on-site wastewater treatment through a package treatment plant system that can be expanded as development of each project phase proceeds. The specific on-site septic system facilities option selected by the County will meet Stanislaus County's Guidelines for Septic System Design.<sup>3</sup>

A package treatment plant system can accommodate the wastewater discharge from multiple lots or different buildings on the same lot and can potentially include tertiary treatment. "Specific on-site septic system facilities" are individual onsite wastewater treatment systems (OWTS) developed for a building or lot. This type of system would treat effluent only to a primary and secondary level.

At the time of preparation of this Specific Plan, the County cannot determine which type of system will be necessary for any specific development within the Specific Plan area. Soil composition and size, use, and occupancy of buildings/lots (among other factors) would determine the size and type of system needed. A system that treats industrial waste would also need to comply with different requirements and permitting/oversight of the Central Valley Regional Water Quality Control Board (RWQCB).

According to a Technical Memorandum prepared by Blackwater Engineering, Potential Impacts to Patterson Wastewater Facilities from Crows Landing Industrial Business Park (August 25, 2017), the City of Patterson's existing wastewater collection system does not have sufficient capacity to accept CLIBP Phase 1 flows and accommodate known potential developments in the City of Patterson. Flows to the Patterson WQCF are projected to exceed the existing reliable capacity of 1.85 mgd ADWF within the next five years. The process for design, permitting, and construction for expansion of the WQCF could take up to 12 years total. Depending on timing of development in Phases 1 and 2, the County may need to construct a temporary on-site septic system (temporary package treatment plant or other suitable option) to handle wastewater needs for part, or all, of Phase 1 and part of Phase 2. The County could subsequently connect to Patterson's system. However, the following improvements to the collection system can be implemented to increase capacity in the existing system to accept CLIBP Phase 1 flows.

- a. Replacing pipe segment E5-6:E5:5 on M Street, as previously identified in the WWMP.
- b. Upsizing of approximately 1,300 feet of 21-inch pipe in Ward Avenue.

The following sections identify the anticipated development or improvement of infrastructure to facilitate CLIBP build-out as envisioned in three 10-year phases. However, the timing of proposed wastewater collection system improvements may be subject to change based on the needs of site users and

<sup>3</sup> A package treatment plant is a pre-manufactured facility to treat wastewater in small communities or on individual properties.



timing/location of proposed on-site development. Phasing of the wastewater collection system will coincide with on-site roadway construction and phasing of development to supply adequate services.

#### 4.4.2 Wastewater Collection System

##### Service to the City of Patterson

###### *Phase 1*

Backbone infrastructure constructed during Phase 1 will include a wastewater collection system for the Fink Road Corridor during Phase 1A and for the airport, southern Public Facilities Area, and Bell Road Corridor in Phase 1B.

- Phase 1A: Construction of backbone infrastructure, includes:
  - Gravity trunk main;
  - 2.70-MGD sanitary sewer lift station southwest of the W. Marshall Road and SR 33 intersection;
  - 0.32-MGD sanitary sewer lift station south of the airport near the DMC;
  - A force main within W. Marshall Road to convey effluent to the existing WHWD trunk main in Ward Avenue;
  - Tunneler crossing of the DMC south of the airport;
  - Replacement of pipe segment: E5-6:E5:5 on M Street in the City of Patterson; and
  - Upsizing the existing 21-inch sections of the Ward Avenue trunk sewer to 24-inches to accommodate potential growth in Patterson and CLIBP Phase 1 flows.

Construction of the Phase 1A gravity trunk main system includes installation of lines with pipes ranging from 8 inches to 18 inches in diameter and manholes. The gravity trunk mains and the lift stations to be constructed in Phase 1A are sized to accommodate ultimate expansion within the Plan Area and the force main constructed in Phase 1A is sized to accommodate effluent from all phases. The County may allow leaseholders/tenants initiating development during Phase 1 to use new on-site septic systems (packaged wastewater treatment facility) until the permanent sewer system and connection to the City of Patterson WQCF has been completed for their area. The specific on-site septic system facilities will meet Stanislaus County's Guidelines for Septic System Design. Permanent on-site facilities are anticipated to serve development during part or all of Phase 1A.

During Phase 1A, the County will convey the CLIBP sewer flows from Phase 1A development to the WHWD Ward Ave. trunk line down to the City of Patterson Ward Ave. trunk line, which flows to the City of Patterson's WQCF.

- Phase 1B: Construction of backbone infrastructure for wastewater improvements are limited to collection system piping ranging from 8-inches to 15-inches in diameter and manholes. During Phase 1B, the County will tie in to the Phase 1A corridor sanitary sewer infrastructure to convey the combined Phase 1A and Phase 1B CLIBP sewer flows to the WHWD Ward Ave. trunk.

### Phase 2

Construction of Phase 2 infrastructure for wastewater service includes installation of gravity trunk mains to connect to existing sanitary sewer infrastructure constructed in Phase 1, with pipes ranging from 8 inches to 12 inches in diameter and manholes, removal of the temporary connection to the WHWD's sanitary sewer trunk line, and installation of a 12-inch diameter force main parallel to the existing WHWD sewer trunk line along Ward Avenue between W. Marshall Road and Bartch Avenue for connection to the proposed South Patterson Trunk Sewer (SPTS) line (City of Patterson's Wastewater Master Plan, 2010). This new trunk line will be utilized to convey CLIBP-generated sewage to the City of Patterson WQCF.

Construction of the SPTS system was recommended by Blackwater before accepting CLIBP flows up to the estimated project buildout average dry weather flow (ADWF). The system would be built to accommodate full buildout flows from Diablo Grande, CLIBP, and South Patterson

### Phase 3

Construction of Phase 3 infrastructure for wastewater service includes installation of lines with pipes ranging from 8-inches to 10-inches in diameter and manholes. This phase will utilize the newly constructed parallel force main system in Ward Ave. to convey CLIBP sewer flows to the City of Patterson. The SPTS will carry build-out flows from the CLIBP to the expanded City of Patterson WQCF.

Figures 4-16 to 4-18 illustrate phasing of the wastewater system improvements. The d/D ratios referenced in the figures is a measure of the depth of flow to the pipe diameter. The ratio helps to determine how full the pipe is in gravity systems.

According to the City of Patterson's Wastewater Master Plan (2010), the permitted capacity of 3.5 MGD does not account for development outside the City's 2004 sphere of influence; therefore, facility expansion may be required to handle project-related effluent. The timing of such expansion will be determined through coordination with the City of Patterson.

Comparing projected CLIBP sewer flows to the existing and anticipated available capacities of the City of Patterson trunk lines, the following trunk line infrastructure phasing plan for each phase of CLIBP build-out is described as follows:

#### On-Site Treatment Alternatives

If the preferred option to transport CLIBP effluent to the City of Patterson WQCF is infeasible, the County will develop a plan to provide on-site wastewater treatment through a package treatment plant system that can be expanded as development of each project phase proceeds (see Section 7.2 of the *Crows Landing Industrial Business Park Sanitary Sewer Infrastructure and Facilities Study* in Appendix H). Packaged or custom wastewater treatment systems, complying with California Title 22 recycled water regulations and State Water Board wastewater discharge regulations can be constructed on the CLIBP property to manage its wastewater over time. Modular treatment systems can be matched to the treatment capacity required for each phase and constructed as needed, not unlike the phased expansion projects that the City of Patterson is planning with its WQCF.

To compare an on-site wastewater treatment system (OWTS) to the option of disposal at the Patterson WQCF, an assessment was made of treatment systems for the full buildout wastewater ADWF. Two types of modular, packaged treatment systems were considered: Sequencing Batch Reactor (SBR) and Membrane Bioreactor (MBR) Process. For initial developments with OWTS for individual facilities, the County has permitting authority and mechanisms available to evaluate, approve and permit such systems. State criteria are

mostly siting based and the County would remain the lead agency as long as treated effluent cannot percolate into groundwater or migrate into surface waters.

#### **4.4.3 Wastewater Goal**

The following goal applies to CLIBP on-site and off-site wastewater collection system improvements:

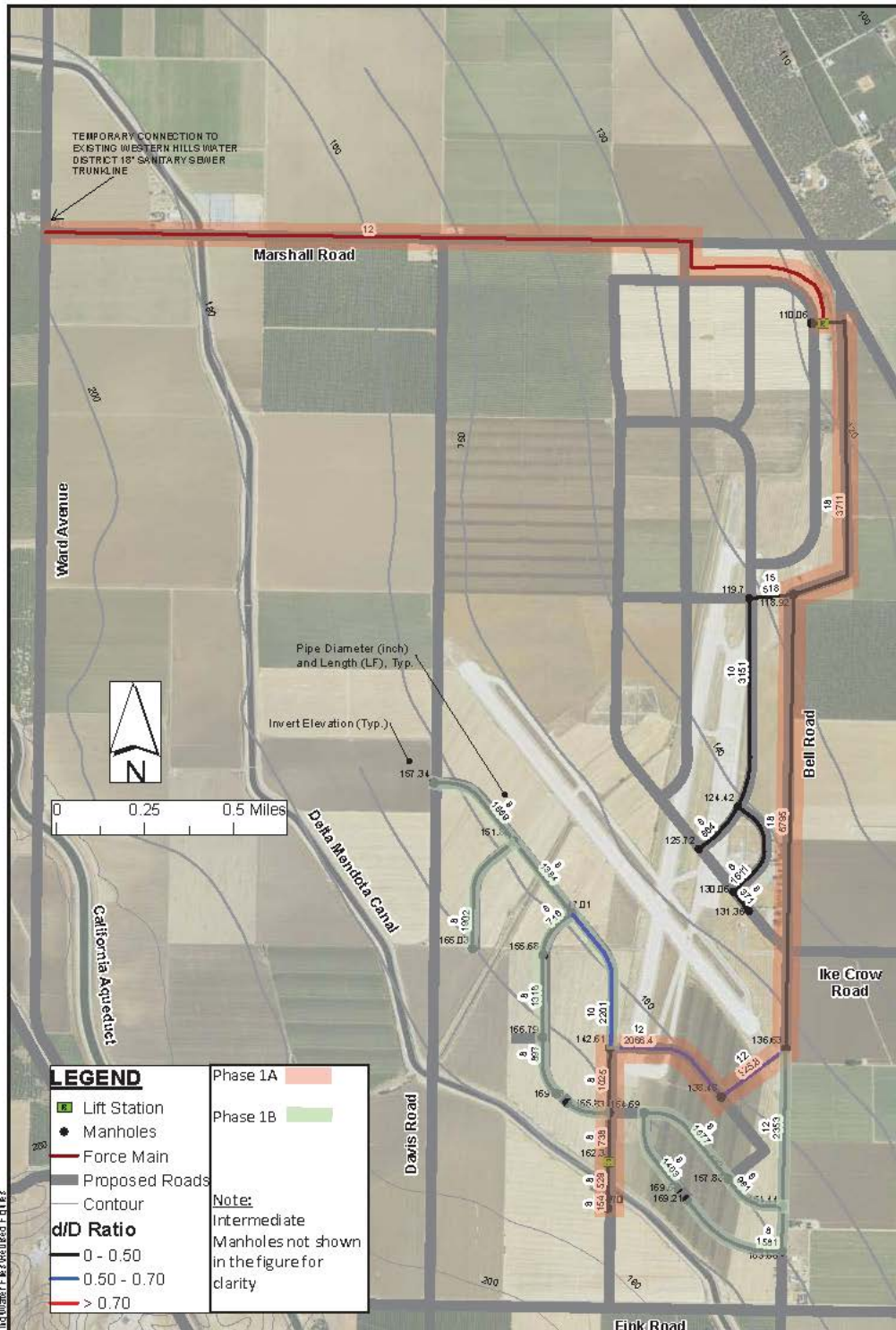
WWG 1: Provide a wastewater collection system and treatment sufficient to serve build-out of the CLIBP Plan Area.

#### **4.4.4 Wastewater Policies**

The following policies apply to CLIBP on-site and off-site wastewater collection system improvements:

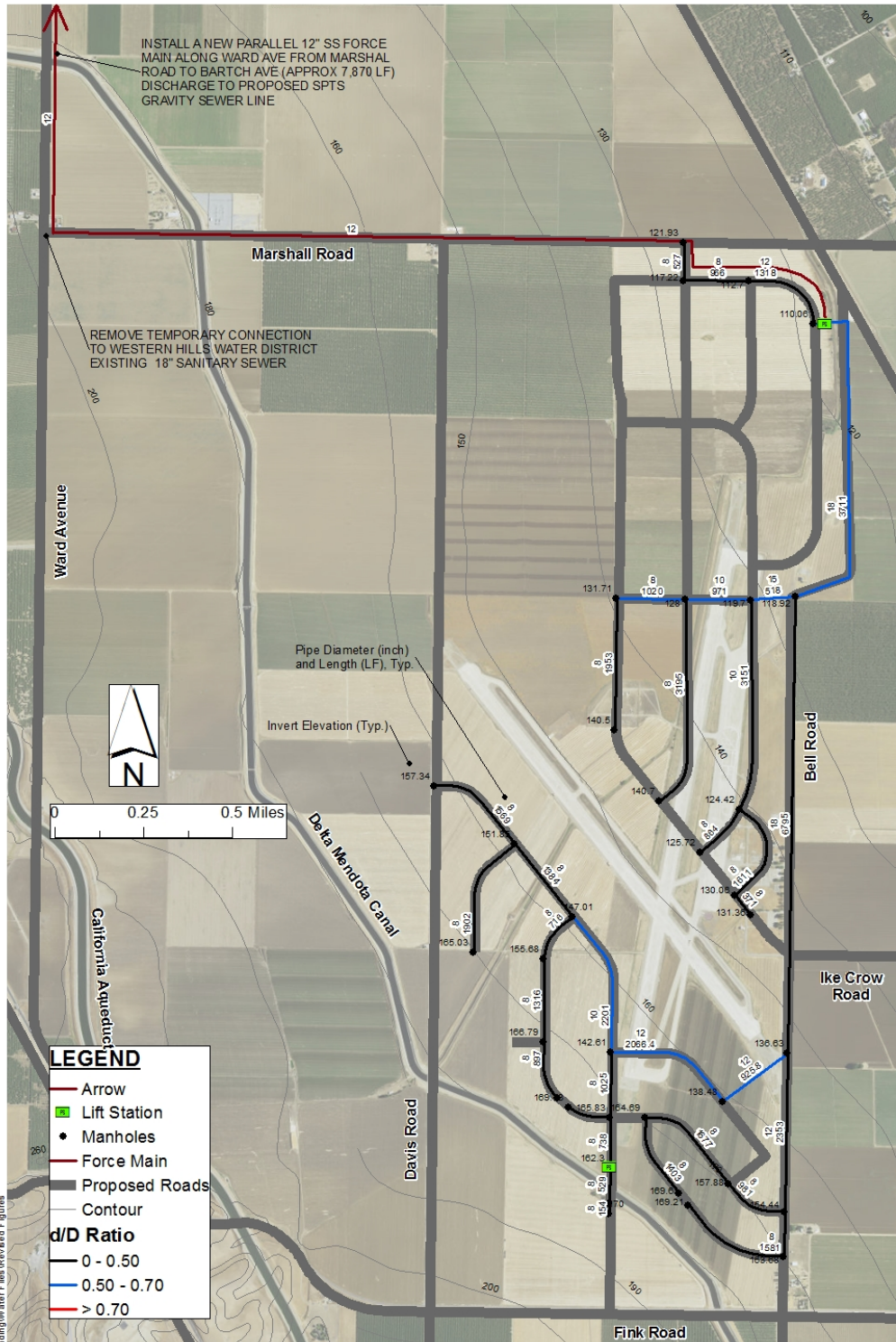
WWP 1: Initial wastewater system infrastructure shall be constructed to provide service to the Fink Road Corridor and extend to the Bell Road Corridor, airport, and southern Public Facilities Area, and accommodate effluent from all phases.

WWP 2: Future leaseholders/developers/contractors shall submit a wastewater budget indicating the total wastewater demand, the quality of the wastewater, and the opportunities for use of reclaimed wastewater, where appropriate.

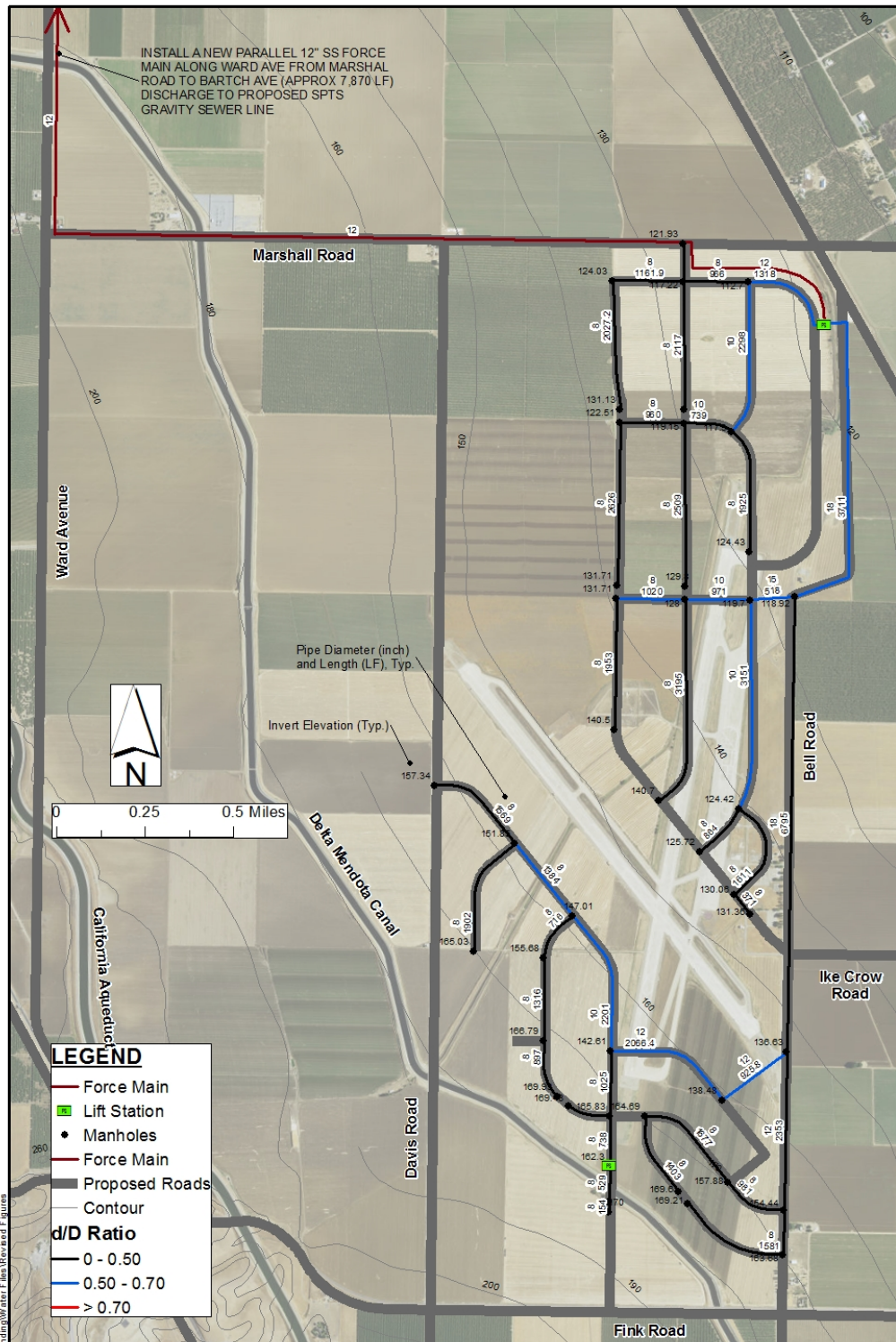


Source: AECOM 2016  
 Figure 4-16: Wastewater System, Phase 1

Note: The d/D Ratio represents the relationship between the maximum depth of flow and diameter of the pipe and is used to model the ability of a pipeline to convey wastewater flow under both dry weather and wet weather conditions.



Source: AECOM 2016  
 Figure 4-17: Wastewater System, Phases 1 and 2



Source: AECOM 2016  
 Figure 4-18: Wastewater System, Phases 1, 2, and 3

## 4.5 STORMWATER MANAGEMENT

The terrain west of I-5 is characterized by rolling hills with elevations ranging from 220 feet to 1,400 feet above mean sea level (msl). Upstream watersheds east of I-5 between the California Aqueduct and the DMC consist of land that generally slopes to the northeast. Stormwater runoff from the Little Salado Creek watershed west of the California Aqueduct crosses both I-5 and the California Aqueduct and then flows toward the DMC. Flow is conveyed under the DMC by two, 5-foot-square box culverts that have capacity for 700 cubic feet/second (cfs). During a 100-year, 24-hour storm event, the creek would result in a peak flow discharge of 700 cfs of stormwater to the Plan Area.

On the east side of the DMC, box culverts drain into an open channel that continues in a northeasterly direction through the Plan Area and passes through the culverts that convey flows beneath the former military runways. The open channel ultimately drains toward the low point of the Plan Area, which is located near the intersection of SR 33 and Marshall Road. From this low point, runoff drains through a linear sedimentation basin towards a raised concrete control structure. The control structure contains a 24-inch outlet controlled by a slide-gate valve, which discharges to the 24-inch “Marshall Drain.” The Marshall Drain runs parallel to Marshall Road for approximately 4.3 miles to its final discharge point at the San Joaquin River.

Specific development projects in the Plan Area will be required to detain stormwater runoff associated with a 100-year storm event on site. This requirement will reduce the amount of runoff to be conveyed or detained downstream and reduce the amount of drainage infrastructure required. However, excess runoff is known to accumulate in the northeast portion of the Plan Area, primarily as a result of limited discharge capacity within the Marshall Drain. During heavy rainfall events under existing conditions, runoff pools against the adjacent railroad tracks located on the east side of SR 33, eventually over-tops the railroad, and then flows northwesterly towards the San Joaquin River. In addition, flows migrate north towards the City of Patterson and contribute to flooding. Development of the Plan Area will require the construction of stormwater drainage infrastructure to accommodate off-site runoff from upstream tributary areas.

The following sections identify the anticipated development or improvement of infrastructure to facilitate CLIBP build-out as envisioned in three 10-year phases. However, the timing of proposed stormwater management improvements may be subject to change based on the needs of site users and timing/location of proposed on-site development.

### 4.5.1 Stormwater Management Plan

As further described in the Drainage Study for Crows Landing Industrial Business Park (Appendix I), referred to herein as the Drainage Study, Plan Area development will include new stormwater management and groundwater recharge infrastructure as part of the backbone infrastructure provided by the County. Such facilities will include:

- Raising an approximately 750-foot segment of Davis Road located off site and south of the DMC by approximately 4 feet during Phase 1A to protect the area west of the DMC and block flows from ponding in the Plan Area;
- Increasing the capacity of Little Salado Creek during Phase 1B by widening the channel downstream of the runway and increasing the capacity of the culverts that convey water flows beneath the runway. Off-site runoff flows will be conveyed to the northeastern corner of the Plan Area through the expanded open channel and culverts;

- Constructing an on-site stormwater pond in the northeastern portion of the Plan Area, beginning in Phase 1B. The linear pond will be constructed along the northeastern site boundary to accommodate the increased flows coming from Little Salado Creek and culverts beneath the runway and also to detain and infiltrate runoff from Little Salado Creek, to promote groundwater recharge.

Figure 4-19 shows the segment of Davis Road that will be raised, the segments of Little Salado Creek that will be widened, and the location of the proposed stormwater pond.

In addition, on-site stormwater will be collected from rooftops, parking lots, and roadways and conveyed through a system of pipes, swales, and ditches, on-site detention/infiltration basins, Little Salado Creek channel and the stormwater pond, such as the County may require on site for individual developments. The stormwater pond will be used to detain and infiltrate stormwater runoff for groundwater recharge.

Based on its proximity to the runway, the channel design must address guidance set forth in Federal Aviation Administration (FAA) orders and guidance. FAA Order 13, Design, provides guidance for drainage facilities constructed on airports. FAA Advisory Circular 150/5200-33B, “Wildlife Hazard Attractants on and Near Airports,” provides guidance for open water facilities constructed within the critical zone for wildlife hazards, which is defined as the area within 10,000 feet of aircraft movement and within 5 miles of approach departure areas. Such guidance requires that water associated with a 10-year storm drain within 24 to 48 hours of the storm event.

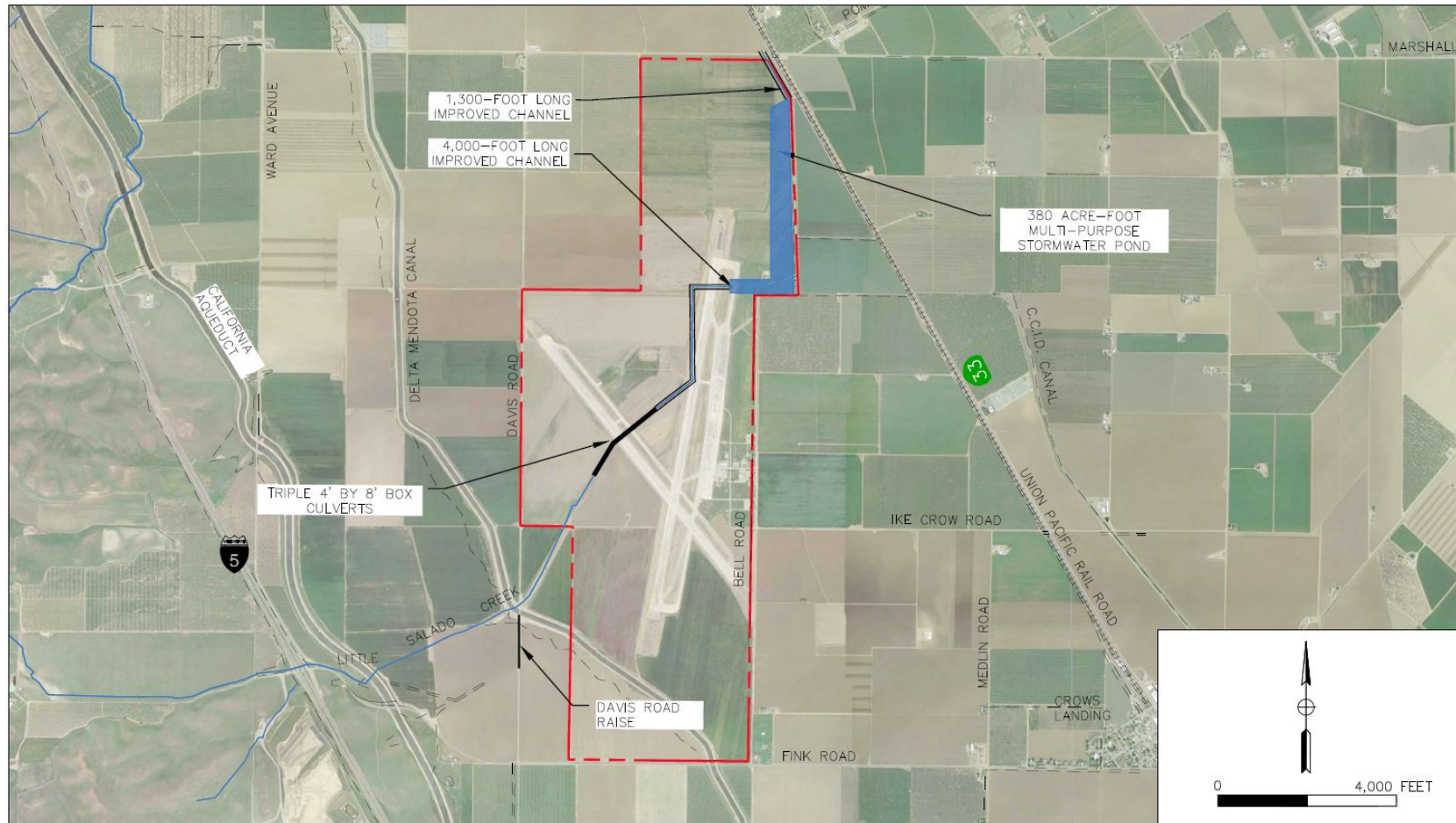
Widening Little Salado Creek channel and increasing the capacity of the culverts under the airport runway will allow runoff that currently accumulates on-site to be conveyed across the Plan Area and will eliminate off-site pooling along the adjacent railroad tracks. However, peak flows that travel north towards Patterson would be increased without mitigation. An on-site stormwater pond will be constructed to mitigate the northward flows towards Patterson. The stormwater pond will be constructed on site along the northeastern boundary. The pond will be constructed to detain runoff from Little Salado Creek. The pond will have a capacity of 380-acre feet over an area of approximately 40 acres, consisting of 200-acre feet of runoff retention storage (for infiltration) in the bottom and 180-acre feet of runoff detention storage above. Based on the ponds proximity to the airport, the pond will be designed and constructed in accordance with guidance set forth in FAA Advisory Circular 150/5200-33B, and it will include a small outlet structure to allow the pond to drain completely within 48-hours of a 10-year storm event.

If the County selects an on-site wastewater treatment alternative (refer to the *CLIBP Wastewater Master Plan* for additional details), one option will be to discharge highly treated effluent to the stormwater pond for infiltration into the upper aquifer. This would require a re-evaluation of the area of pond bottom that would receive engineered improvements to enhance infiltration.

If necessary and feasible to provide adequate flood protection and minimize stormwater runoff, the County may also implement one or more of the following improvements:

- Increase the capacity of the culvert under the DMC to allow runoff to pass under the canal to prevent Plan Area ponding. This option would require increasing the capacity of the proposed stormwater pond and the channel. These improvements would begin as part of Phase 1B.
- Placing fill on the parcel to raise the site to prevent ponding. The fill would result in a similar condition as the raising of Davis Road and require other improvements to address runoff on properties to the northwest. These improvements would begin as part of Phase 1A.





Source: AECOM 2016

Figure 4-19: Stormwater Drainage Improvements

\* Note: An on-site wastewater treatment alternative, with the option to discharge highly treated effluent to the stormwater pond, may require engineering improvements to the pond.

- Restrict development to areas outside the floodplain. This would result in about 20 acres of land that could not be developed but could be used as open space and for the required detention from the on-site runoff (see Section 4.6.2).
- Engineering improvements to enhance infiltration of the stormwater pond if an on-site wastewater treatment system is required.

According to the March 2017 *Drainage Study for Crows Landing Industrial Business Park* (Appendix H to the Specific Plan, Section 3, Table 6), the open space/detention pond would be constructed in phases as the project develops and additional stormwater detention is required. The total volume of planned detention is 615,000 cubic yards (cy), of which 368,807 cy would be constructed in Phase 1B, 113, 925 cy in Phase 2, and 132,268 cy in Phase 3. Along with the detention basin, earthworks will be the construction of supporting drainage infrastructure in Phase 1B and infiltration trenches in Phases 1B, 2, and 3, as detailed in Table 6 of the Drainage Study.

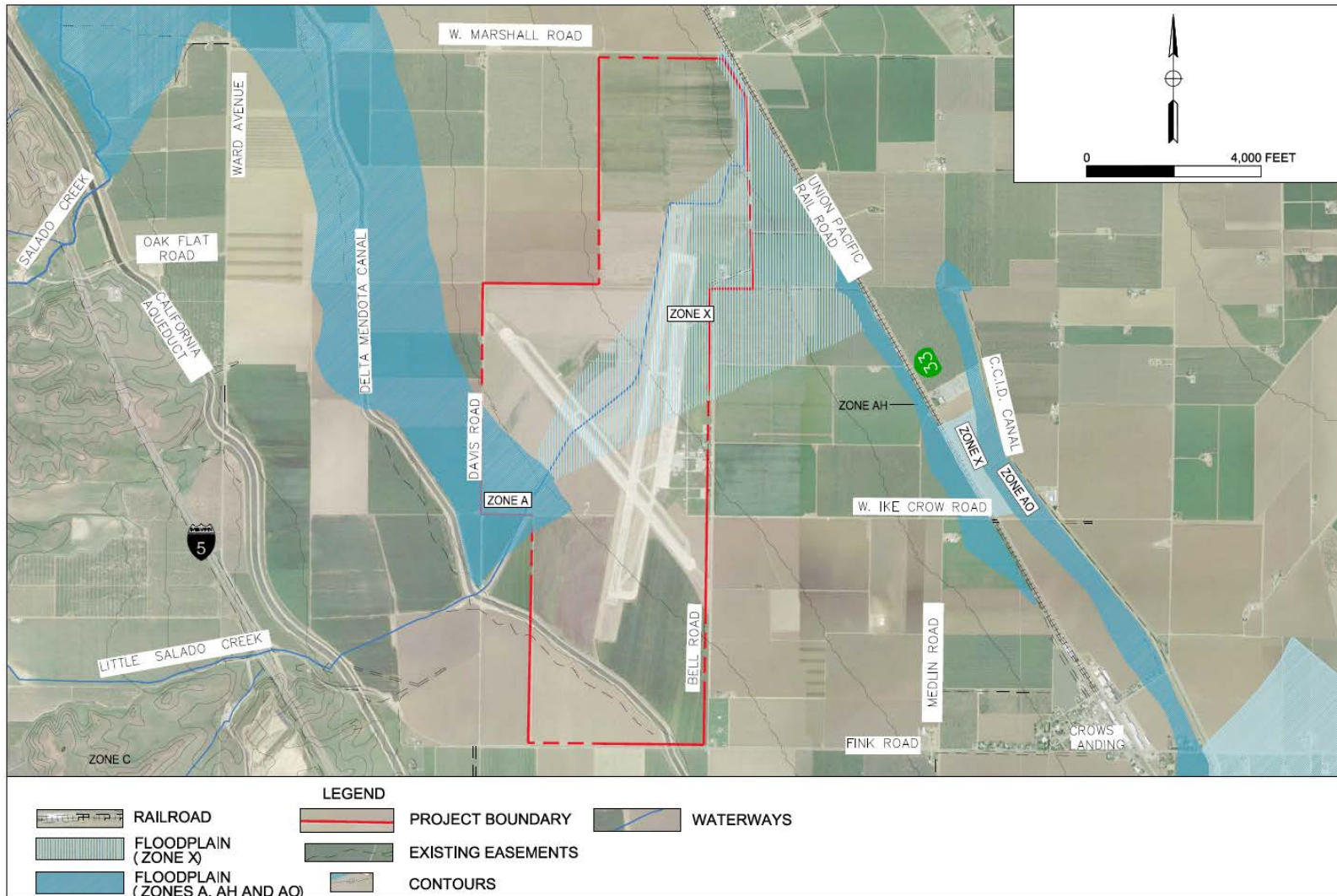
### ***Groundwater Recharge***

In 2014, California adopted the Sustainable Groundwater Management Act (SGMA), which provides a framework for sustainable management of groundwater supplies by local authorities. Subsequently, in 2015, California updated its Model Water Efficient Landscape Ordinance (California Water Code, Title 23, Chapter 2.7) to promote water efficient landscapes, better manage landscape water use to prevent waste, and reduce water use to the lowest practical amount. Prior to SGMA, Stanislaus County adopted a Groundwater Ordinance (chapter 9.37 of the County Code) to prevent the unsustainable extraction of groundwater within unincorporated areas and promote no net drawdown of aquifers. Chapter 3 and Appendix B contain policies, development standards, and design guidelines to implement the State of California's and the County's policies and requirements related to sustainable groundwater extraction and use.

With the application of water efficient landscape standards and the construction of the stormwater pond with retention storage for infiltration and groundwater recharge, potential groundwater extraction to serve the CLIBP at build-out is intended to provide sustainable groundwater yields. As noted in Section 4.3, "Water Supply and Distribution," to meet the County's objective of no net drawdown of groundwater, a sustainable groundwater recharge strategy, including potential use of reclaimed water, will be adopted in order to maximize groundwater recharge. The details of the strategy will be developed separately from the Specific Plan, but would generally consist of the design and construction of water detention facilities to reduce flow and increase permeability and water infiltration.

### **4.5.2 Floodplain Mapping**

Figure 4-20 shows that the existing Federal Emergency Management Agency (FEMA)-defined floodplain covering the project site includes designations for Zone A (100-year no elevations determined) and Zone X (500-year or 100-year with depths less than 1 foot). FEMA permits the County Flood Plain Manager to allow development in A Zones if base flood elevations have been determined and the development is outside the limits of the 100-year floodplain. Zone X areas allow development without flood insurance.



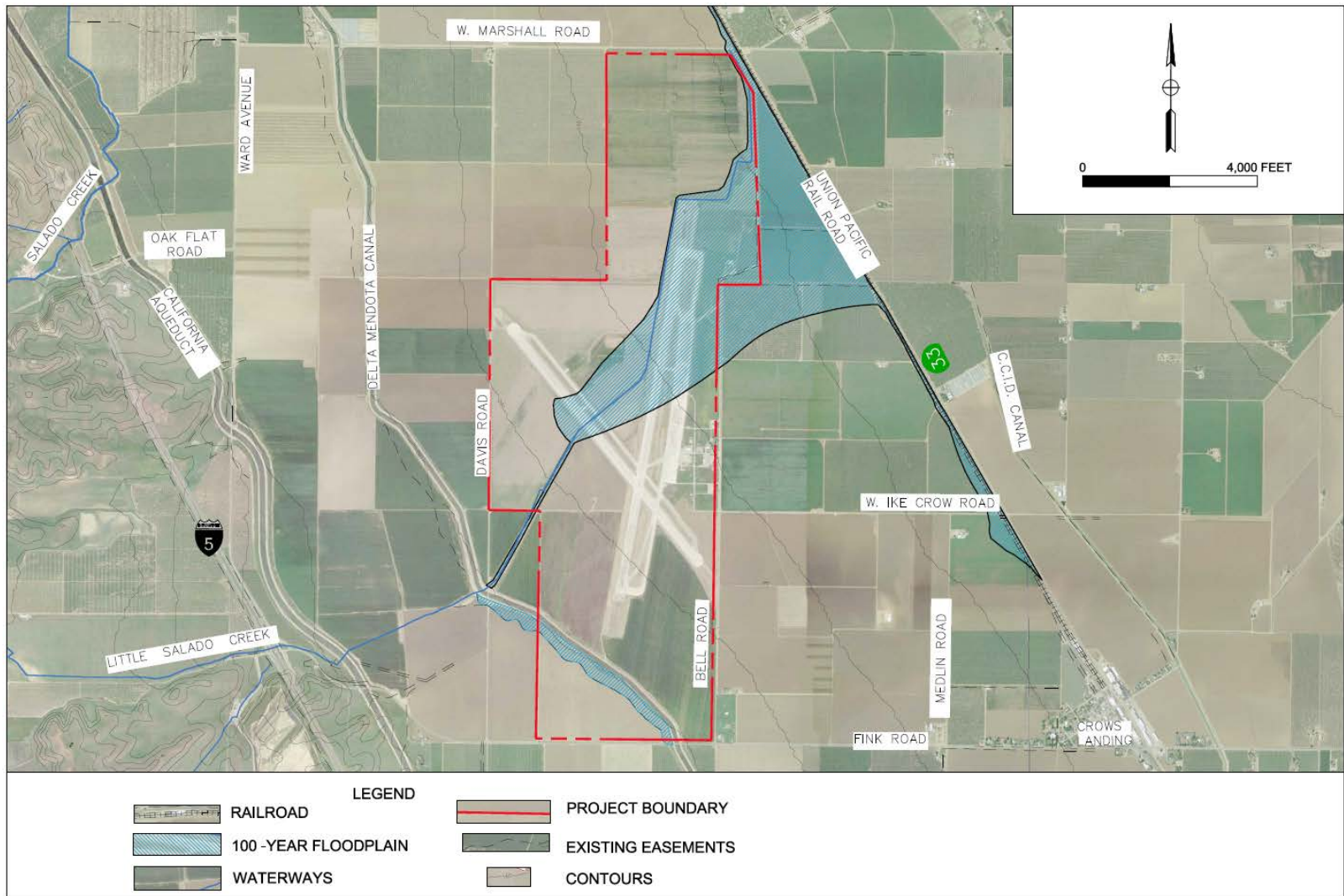
Source: AECOM 2016  
 Figure 4-120: FEMA Floodplain

Based on the Drainage Study, the County has determined that the existing FEMA floodplain designation for Zone A (see Figure 4-20) is incorrect. As part of the study, peak flows on Salado Creek were investigated to determine whether runoff from the watershed was combining with runoff from Little Salado Creek to create the larger floodplain shown in the FEMA map. Using a one-dimensional hydraulic model to simulate a 100-year flood event, the analysis indicated that flood elevation would be contained within the channel in the Zone A area. However, as shown in Figure 4-21, hydraulic modeling results indicate that Little Salado Creek would experience overtopping at locations where the channel is too narrow and where the culverts convey flow under the existing airport. Figure 4-22 compares the location of the 100-year flood event as indicated by the hydraulic model compared to the floodplain shown by the existing FEMA map.

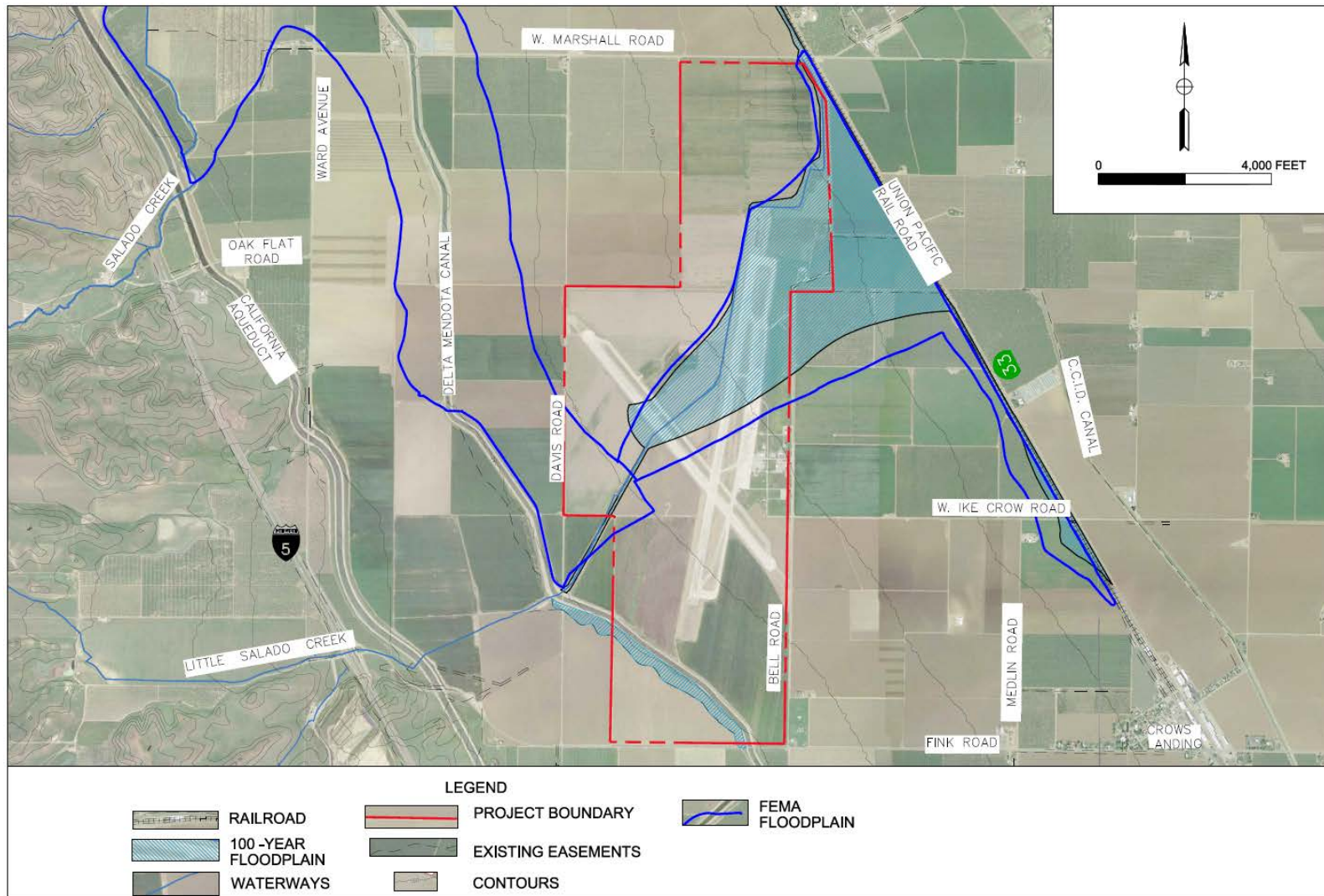
The capacity of the culverts beneath the runway must be increased, and the Little Salado Creek channel must be improved prior to and during development. The analytical results obtained from the hydraulic model showed that flood flows would be conveyed without overtopping the creek by widening the channel, providing better maintenance, and increasing the capacity of the culverts under the runway. The stormwater pond will mitigate for the resulting increased flow (see Figure 4-23).

A Conditional Letter of Map Revision (CLOMR) is not necessary for project entitlement; only a small portion of the site is in the FEMA floodplain, and project development can still be permitted. However, after the stormwater improvements have been made, the County will need to process a Letter of Map Revision (LOMR) for the section of Plan Area currently in FEMA Zone A, so that development on this portion of the project will not be subject to development restrictions, including flood insurance.

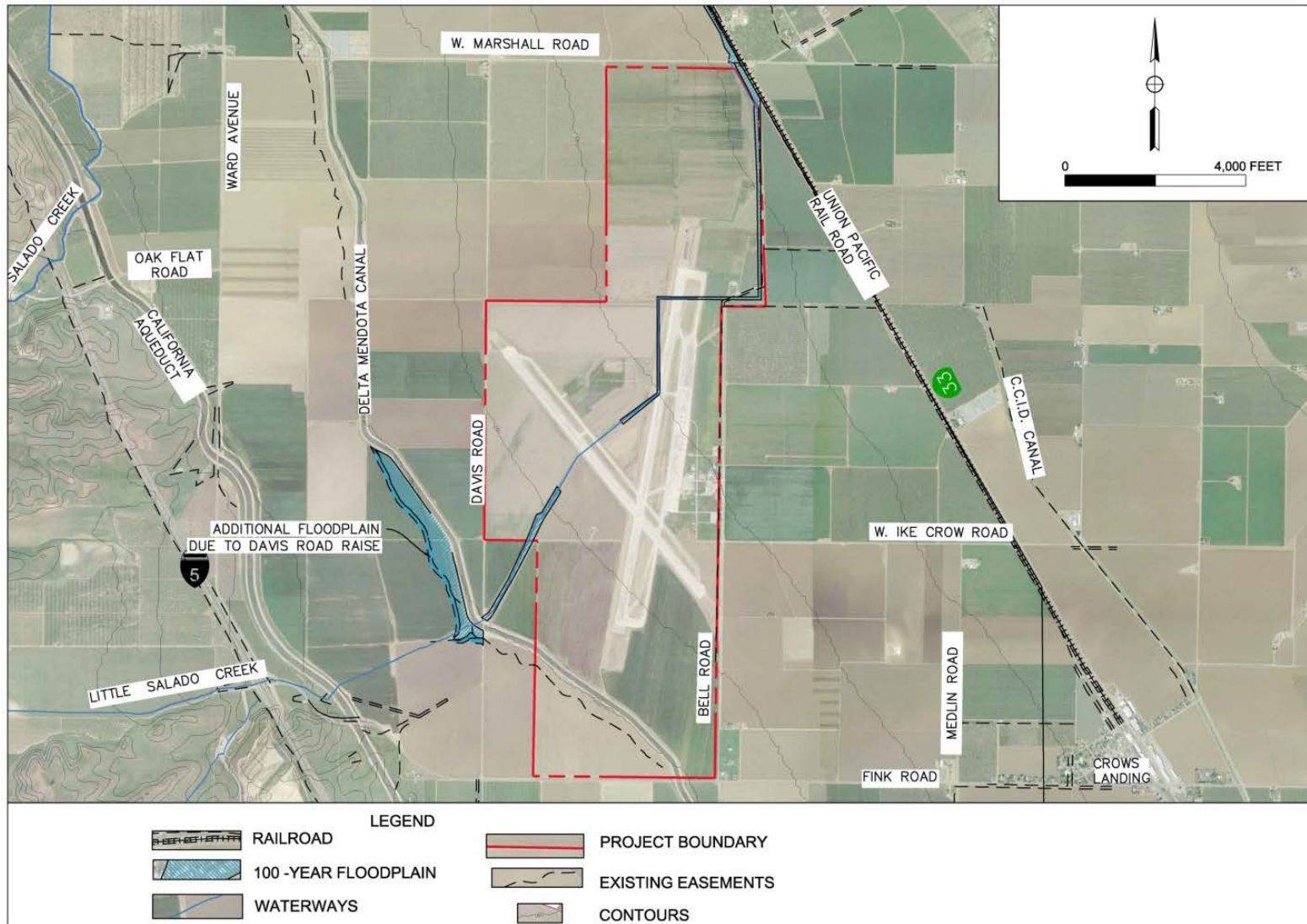
Raising Davis Road will protect the portion of Plan Area west of the DMC from flooding, but will cause more area to the west of Davis Road to be inundated during large flood events. The inundation will be deeper than under current conditions, however, the duration will be short. The existing floodplain west of the DMC is not currently mapped by FEMA so no letter of map change will be required as part of this development. In the future, if the area west of Davis Road is mapped by FEMA it would probably be categorized as a Zone A or Zone AE (100-year elevations determined).



Source: AECOM 2016  
 Figure 4-21: Existing Floodplain (Based on Hydraulic Modeling Results)



Source: AECOM 2016  
 Figure 4-22: FEMA and Existing Floodplain Comparison



Source: AECOM 2016

Figure 4-23: Proposed FEMA Floodplain (Following Project-related Improvements)

### 4.5.3 Stormwater Management Goal

The following goal applies to CLIBP on-site stormwater management improvements:

SG 1: Provide a stormwater management system, incorporating groundwater recharge facilities, sufficient to serve the projected growth and build-out of the CLIBP Plan Area.

### 4.5.4 Stormwater Management Policies

The following policies apply to CLIBP on-site stormwater management improvements:

- SP 1: All development shall detain stormwater runoff associated with the 100-year storm event, on site.
- SP 2: All on-site detention facilities shall be designed according to guidance set forth in FAA Advisory Circular 150/5200-33B.
- SP 3: Grassy swales and other best management practices to filter stormwater shall be encouraged and shall comply with the Landscape Design Policies in Section 3.3.2 of Chapter 3, “Built Environment and Design.”
- SP 4: On-site stormwater detention features, basins or swales, used as a landscape design feature may be considered for credit against the required landscape area on any site, provided that:
- The detention basin or swale is visually incorporated in the adjacent site landscape;
  - The detention basin or swale may be landscaped to include grass, trees, and other improvements that are similar to, and visually compatible with, the adjacent landscaping, but the features shall not create large areas of open water or other habitat for potentially hazardous wildlife; and
  - The detention basin or swale is located in the front setback where it is visible from the road, or is part of the on-site landscaped area in the side yard or rear yard setback areas visible from the road or the occupied area of buildings on site.
- SP 5: Stormwater management swales shall be landscaped with appropriate erosion control plant materials.

## 4.6 DRY UTILITIES PLAN

All dry utilities, including electricity, gas, telephone, cable, and internet will be conveyed through the major Plan Area roads in a “joint trench” and parallel to backbone roads. The Crows Landing Industrial Business Park Dry Utilities Infrastructure and Facilities Study (Appendix J), herein referred to as the Dry Utilities Study, identifies the major infrastructure elements required to provide sufficient electricity, natural gas, and communications to the Plan Area.

### *Electricity*

According to the Dry Utilities Study, representatives of the Turlock Irrigation District (TID), which currently serves the project area, state that TID has electrical capacity to serve the CLIBP; however, electrical distribution infrastructure is required. TID is capable of generating slightly more than 505 megawatts (MW) of electricity throughout a 662-square-mile service area, including the Plan Area. A TID substation is located at the northeast corner of W. Marshall and Davis roads. This substation is fed from a double circuit 115 kilovolt (kV) line with a 12kV under build located along W. Marshall Road on the northern boundary of the CLIBP Plan Area. TID will require 15- to 20-foot-wide public utility easement to accommodate electricity



facilities. Manholes will be required at 800-foot-intervals to accommodate underground electrical facilities, which will include 4-inch and 6-inch diameter conduits. Pad-mounted switchgear and pad-mounted capacitor banks could also be required.

### ***Natural Gas***

Pacific Gas and Electric Company (PG&E) provides natural gas and electric service throughout a 70,000-square-mile service area in northern and central California. A 24-inch diameter transportation pipeline is present on the northern boundary of the Plan Area, and a 3-inch diameter gas-distribution pipeline runs from I-5 along the southern boundary of the Plan Area to serve the community of Crows Landing. PG&E would realign the gas lines to serve the CLIBP.

### ***Communications***

AT&T and Global Valley Networks (GVN) currently provide telephone communications to the CLIBP project area, and both have stated that they will provide telephone services to the Plan Area (CLIBP Dry Utilities Infrastructure and Facilities Study, 2015). AT&T provides local phone service, long distance phone service, and high-speed internet service throughout Stanislaus County. GVN provides telephone and internet services to the nearby communities of Patterson, Livingston, Diablo Grande, Westley, and Grayson. Manholes will be required at 600-foot intervals to accommodate underground communication facilities, which will include 4-inch diameter conduits for telecommunication cable distribution.

Comcast provides service to the Crows Landing community, but it will need to extend its existing fiber optic cable from the Crows Landing community to provide cable television and internet service to the Plan Area. Underground facilities will include a 2-inch diameter conduit and manholes for cable distribution.

#### **4.6.1 Dry Utilities Goal**

The following goal applies to CLIBP dry utilities improvements:

DUG 1: Ensure that infrastructure for dry utilities, including electricity, natural gas, and communication services is sufficient to serve the projected build-out and growth of the CLIBP Plan Area.

#### **4.6.2 Dry Utilities Policies**

The following policies apply to CLIBP dry utilities improvements:

- DUP 1: Specific infrastructure requirements for TID, PG&E, AT&T, GVN, and Comcast shall be determined prior to initiating Plan Area development.
- DUP 2: The County shall work with TID to ensure that the local electricity distribution grid is in place in a timely manner to serve CLIBP users.
- DUP 3: Electric lines 12kV and smaller shall be located underground.
- DUP 4: All facilities shall be constructed to avoid conflicts with on-site aviation.
- DUP 5: The County shall work with PG&E to ensure timely provision of natural gas service to CLIBP users.
- DUP 6: The County shall work with AT&T, GVN, and Comcast to design and site necessary communication service infrastructure to serve CLIBP users.

DUP 7: Proposed site landscaping designs and architecture shall consider the use of energy conservation to reduce building heating and cooling loads.

#### **4.7 SOLID WASTE COLLECTION PLAN**

The diversity of light industrial, warehouse, distribution, logistics, aviation-related, business, and public facility uses that may occur in the Plan Area indicates that most uses will be served by local franchise or industrial waste haulers under contract with CLIBP users.

Stanislaus County maintains franchise agreements with four different waste hauling companies to operate in four areas of the County. The CLIBP project site is within the area served by Bertolotti Disposal, which provides residential and commercial waste and recycling collection services, as well as temporary small bin and roll-off dumpster rentals.

Solid waste collected from the CLIBP would be hauled to the Fink Road Landfill, which is anticipated to have capacity until 2029 for Class III (inert, nonhazardous solid waste) and 2043 for Class II (waste that may be designated as hazardous or nonhazardous). (Stanislaus County 2014). The County has initiated plans to expand and reconfigure the existing facility to extend its useful life by another 10 to 15 years (2058) (Stanislaus County 2009).

##### **4.7.1 Solid Waste Goal**

The following goal applies to CLIBP solid waste collection services:

SWG 1: Ensure the provision of sufficient solid waste facilities and services to serve CLIBP tenants and compliance with state and local laws, regulations, or executive orders regarding commercial recycling.

##### **4.7.2 Solid Waste Policies**

The following policy applies to CLIBP solid waste collection services:

SWP 1: The County shall work with CLIBP tenants to provide adequate solid waste facilities and ensure compliance with commercial recycling requirements mandated by local or state law, California Department of Waste Management (CalRecycle) regulation, or executive order.

SWP 2: Site users must provide appropriate receptacles that must remain covered or closed at all times.

# SPECIFIC PLAN IMPLEMENTATION

5





## 5.1 OVERVIEW

Chapter 5 presents the procedures that will be used to implement the Crows Landing Industrial Business Park (CLIBP) Specific Plan and subsequent CLIBP Specific Plan area (Plan Area) development projects during the anticipated 30-year build-out period. The purpose of the implementation procedures is to ensure that on-site development projects will support the orderly development of the Plan Area in coordination with the provision of the necessary infrastructure and services and provide sufficient flexibility to respond to fluctuations in the economy and market demand.

Stanislaus County is the public agency responsible for plan implementation, and the County will administer the provisions of the Specific Plan in accordance with all County rules, regulations, and policies:

- Stanislaus County General Plan;
- Stanislaus County Code (including Chapter 21.38 pertaining to the Specific Plan District);
- State of California Government Code Section 65451 (pertaining to specific plans); and
- Stanislaus County Airport Land Use Compatibility Plan (ALUCP).

Additionally, the following documents and technical studies have been prepared in support of the Specific Plan and contain more detailed information on environmental conditions, infrastructure, and financing. As required, these studies may need to be updated or future studies prepared to support the development of the Specific Plan. Any future studies should be included as an appendix section to the Specific Plan.

- Aquatic Resource Delineation Report – Crows Landing Industrial Business Park (Appendix C)
- Airport Layout Plan Narrative Report – Crows Landing Airport (Appendix D)
- Transportation Infrastructure Plan – Crows Landing Industrial Business Park (Appendix F)
- Crows Landing Industrial Business Park Water (Potable & Non-Potable) Supply Infrastructure and Facilities Study (Appendix G)
- Crows Landing Industrial Business Park Sanitary Sewer Infrastructure and Facilities Study (Appendix H)
- Drainage Study for Crows Landing Industrial Business Park (Appendix I)
- Crows Landing Industrial Business Park Dry Utilities Infrastructure and Facilities Study (Appendix J)
- Crows Landing Industrial Business Park Financing Plan (Appendix K)
- Crows Landing Industrial Business Park Environmental Impact Report (see Section 5.2.6)
- Crows Landing Mitigation Monitoring Reporting Program (Appendix L)

## 5.2 SPECIFIC PLAN ADMINISTRATION AND PROCEDURES

### 5.2.1 Specific Plan Area Zoning

The CLIBP Plan Area shall be zoned S-P(2) and developed in accordance with County standards for specific plans in Chapter 21.38 of the County Code.

### 5.2.2 Design and Development Standards

The CLIBP permitted land use and design and development standards shall be adopted by ordinance as Appendix B to the Specific Plan. The design and development standards supplement the Stanislaus County

Zoning Code and will serve as the zoning regulations governing development, improvement, and construction within the Plan Area. Where a standard is not provided in the Specific Plan, the standards of the County's Zoning Code and/or Standards and Specifications shall apply. The standards of Appendix B shall supersede and take precedence over conflicting County Zoning Code standards and/or Standards and Specifications governing the Plan Area.

The design and development standards shall be referenced in coordination with Chapter 3, "Built Environment and Design," of the Specific Plan, to assist future applicants, County staff, the Planning Commission, and Board of Supervisors in evaluating development proposals. Exceptions from the design and development standards in Appendix B may be permitted if determined by the Planning Director or his/her designee to provide a substantially consistent design approach that is equal in quality and design and meets the intent of the original standard.

### 5.2.3 Public Improvement Plans

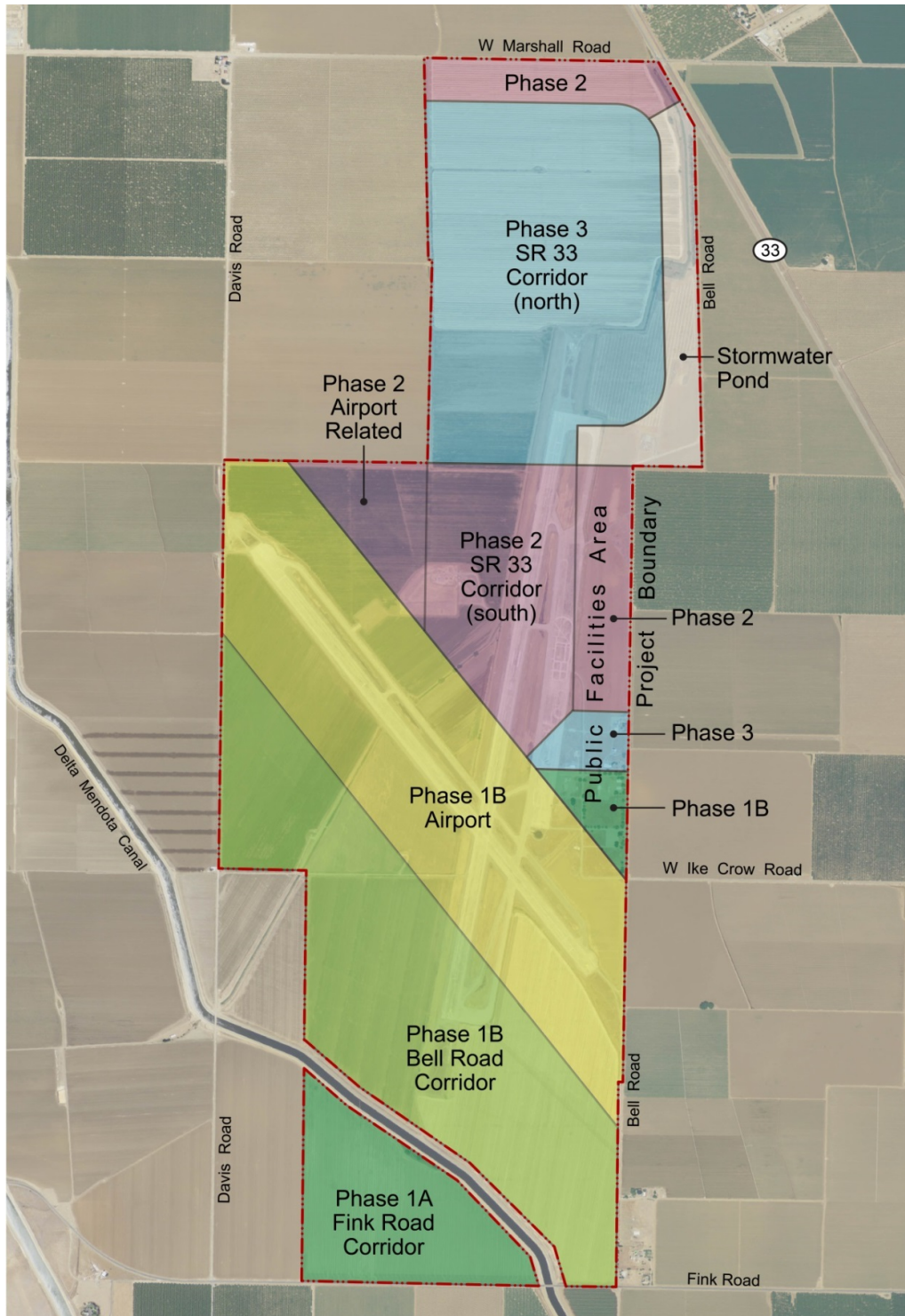
The on-site and off-site public improvements necessary to serve the Plan Area will be designed by the County to accommodate the envisioned Plan Area development and address particular site features. Plans will include an infrastructure sequencing program that coordinates with and allows for orderly development throughout the Plan Area. The sequencing program includes the construction of roads; sewer, water, and stormwater management and groundwater recharge systems; water treatment; and other utilities that must be in place before development can be permitted. Building permits will not be issued until the County's Public Works Director determines that all improvement plans are complete (engineered and approved) and found to be consistent with the CLIBP Specific Plan and Financing Plan. The infrastructure will be sequenced with first phase improvements put in place to provide the backbone infrastructure and support initial Phase 1 development, which is identified as Phase 1A, the Fink Road Corridor and several initial roadway improvements, and Phase 1B, which includes development of the Bell Road Corridor, airport, and the southern portion of the Public Facilities Area (see Figure 5-1). Future infrastructure improvements will be required as remaining leaseholds (lots) within the Specific Plan are developed. However, some improvements will only be needed following full buildout of the Plan Area and the completion of cumulative transportation improvements.

Public improvements, including off-site improvements, will either be installed by the County or by other public agencies with responsibility for those improvements. A fee will be developed to reimburse the upfront costs of each phase of development as it occurs. Should the County decide that a Master Developer would be desirable, a development agreement (DA) will be executed with the master developer. The DA would set out the requirements for the roles and responsibilities of each party.

### 5.2.4 Development Review and Entitlement Process

Following adoption of the CLIBP Specific Plan, subsequent development projects within the Plan Area will be reviewed for consistency and compliance with the Specific Plan and any other County regulations in effect at the time of development. Development projects located in the Plan Area and outside of the Crows Landing Airport boundaries shall be subject to the following review and entitlement processes:

**Permitted Uses.** Uses identified as permitted in Appendix B, Table B-1 of this Specific Plan shall be subject to a site plan review to be conducted independently or as part of the building permit review process. The site plan review shall be considered ministerial provided the project complies with all applicable standards of Appendix B and all other applicable regulations required for issuance of a building permit.



Source: AECOM 2016  
Figure 5-1: Proposed Plan Phasing Areas

The application for site plan review shall be submitted to the County Department of Planning and Community Development (Department) using the application form provided by that Department and subject to fees adopted by the Board of Supervisors. A permitted use that is determined by the Planning Director, or his/her designee, as not achieving the design and development standards presented in Appendix B, shall be subject to the approval of a staff approval permit or require a use permit.

**Staff Approval Permit Required.** Uses identified as requiring a staff approval permit in Table B-1 of the Specific Plan, shall be subject to the requirements of Chapter 21.100, “Staff Approval Permits,” of the County Zoning Ordinance, including filing of a planning application. Uses permitted by staff approval permit may be approved by the Planning Director, or his/her designee, when determined to be consistent and compatible with the Specific Plan and meets the design and development standards of Appendix B.

A Staff Approval Permit shall also be required for consideration of any exception to design and development standards of Appendix B requiring specific findings be made.

**Use Permit Required.** Uses that are not defined as permitted and are determined by the Planning Director or his/her designee to be similar in nature to a permitted use in Appendix B, Table B-1, of the Specific Plan, and not meeting the design and development standards of Appendix B, may be approved. Such uses would be subject to the requirements of Chapter 21.96, “Use Permits,” of the County Zoning Ordinance, and Planning Commission approval subject to Section 5.2.5 Findings Required for Discretionary Action.

**Subdivision.** The most current provisions and procedures of the County Subdivision Ordinance shall apply to any subdivision within the Plan Area.

**Amendment to Specific Plan.** Procedures to amend the Specific Plan shall be those adopted by Stanislaus County. In addition, amendments to the General Plan may be required if a conflict is found to exist with any proposed Specific Plan amendment.

Appendix B of the Specific Plan serves as the regulating ordinance for purpose of implementing the Specific Plan. Any amendment to Appendix B shall be treated as an ordinance amendment subject to Chapter 21.108 Ordinance Amendments of the County’s Zoning Ordinance and shall not be considered an amendment to the Specific Plan itself.

#### 5.2.5 Findings Required for Discretionary Action

Discretionary actions allowed under Section 5.2.4 shall demonstrate all of the following in addition to meeting findings required by the County Zoning and/or Subdivision Ordinances.

1. The project is consistent with the goals and policies of the Specific Plan and all applicable laws and regulations.
2. The project does not propose a substantial change in the overall intensity of land uses.
3. The environmental impacts of the project are addressed by the Specific Plan EIR or by subsequent environmental impact studies that may be required by Stanislaus County under the California Environmental Quality Act (CEQA).
4. The project will not degrade services and/or facilities beyond the capacities approved by the Specific Plan.
5. The project is consistent with the Specific Plan phasing and has the available infrastructure to serve the development.



### 5.2.6 Environmental Review

The CLIBP Specific Plan is a project as defined by the California Environmental Quality Act (CEQA), and is subject to environmental review and documentation as specified in CEQA. CEQA requires lead agencies to disclose and consider the environmental consequences of projects for which they have discretionary authority prior to taking action on approval. CEQA also requires lead agencies (either local or state government agencies) to avoid significant environmental impacts wherever feasible, and to mitigate impacts to less-than-significant levels wherever feasible. An Environmental Impact Report (EIR) was prepared and certified concurrently with the approval of the Specific Plan and serves as the basis for subsequent entitlement for proposed development in the CLIBP Plan Area.

CEQA requires all state and local agencies to establish reporting and monitoring programs for projects approved by a public agency whenever the approval involves adoption of either a “mitigated negative declaration” or specified environmental impact findings in an EIR. The Mitigation Monitoring and Reporting Program (MMRP) (Appendix L) established for the Specific Plan, which is provided as an appendix to the Final EIR, shall be used by County staff and the project developers to ensure compliance with adopted mitigation measures during project implementation. Monitoring and documentation of the implementation of mitigation measures will be coordinated as outlined in the MMRP. Design and development standards contained in Appendix B have been written to: 1) mitigate environmental impacts that can be appropriately addressed through these standards and 2) facilitate development approval and ensure implementation of the MMRP.

### 5.2.7 Specific Plan Interpretation

The Planning Director or his/her designee shall be responsible for interpreting the provisions of the Specific Plan. Interpretation shall be considered a staff decision and may be appealed in accordance with County Code Chapter 21.112, “Appeals.”

## 5.3 INFRASTRUCTURE COSTS AND FINANCING

“Backbone” infrastructure is defined to mean major public improvements designed to serve the entire Plan Area or substantial portions of the Plan Area, and is the minimum infrastructure required to support phased on-site development based on proposed land uses and development densities/intensities. Examples of backbone infrastructure include, but are not limited to, the following:

- New local industrial roads within the Plan Area or improvements to existing streets serving the Plan Area as described in Chapter 3, “Built Environment and Design,” and Chapter 4, “Infrastructure,” including any overcrossing structures and improvements assumed for purposes of the traffic analysis in the EIR;
- Water (potable and non-potable) supply and distribution, wastewater collection and treatment, and stormwater management facilities, as described in Chapter 4, required to serve the Plan Area as a whole, including ancillary facilities such as pumps and other mechanical systems; and
- Other County facilities and/or buildings that serve the Plan Area.

The CLIBP Financing Plan (Appendix K) identifies potential financing mechanisms and funding sources that may be used to finance planned improvements. The financing associated with planned CLIBP improvements/facilities addresses three key components:

- Construction of public improvements and facilities;

- Financing of public improvements and facilities; and
- Financing of ongoing municipal services (including on-going operations and maintenance costs).

While this section provides a general framework for financing infrastructure improvements, the comprehensive Financing Plan has been adopted concurrently with the Specific Plan. The Financing Plan:

- Describes the financial obligation of new development within the Plan Area to pay for cost of backbone infrastructure by estimating the cost to construct backbone infrastructure and identifying financing mechanisms and any existing funding sources for that infrastructure; and
- Estimates the financial obligation of development within CLIBP to pay for the cost of municipal services demands by estimating the cost of those municipal services.

At the end of section 5.3.1 is Table 5-1, which lists proposed infrastructure improvements and estimated costs by phase. Specifics on Phase 1A and 1B costs are detailed in the Financing Plan and Infrastructure Plans.

### 5.3.1 Crows Landing Airport and CLIBP Infrastructure Improvements and Cost

#### *Airport Runway and Facilities Costs*

Approximately 370 acres of the former Air Facility property will be used to construct a new county-owned and operated general aviation airport. The infrastructure improvements required to open and operate the airport were identified in the Airport Layout Plan (ALP) Narrative Report – Crows Landing Airport (2016), which is included as Appendix D of the Specific Plan.

Phase 1 improvements will be constructed to enable the County to obtain an airport operating certificate from the California Department of Transportation’s Division of Aeronautics:

- Design and construct access road, entrance and vehicle parking;
- Install security fence, gate and lights at airport entrance;
- Remove old runway lighting and perform grading of safety areas, object free areas, etc.;
- Repair and remark airfield pavements to provide runway 11-29 (former military Runway 12-30) for visual use;
- Construct four connector taxiways and install taxiway hold signs;
- Install segmented circle and 3 wind cones (non-lit);
- Install ten tie-down positions and prepare five 780-square-foot hangar sites;
- Install modular unit for operations office with restrooms and utility connections (estimated 780 square feet); and
- Install 12,000-gallon skid-mounted general aviation fuel tank (100LL), jet-A refueler truck, truck pad and wash rack.

Additional Airport improvements will be constructed during Phase 2 and Phase 3 based on user demand. Phase 2 and Phase 3 improvements to be provided by the County would include:

- Construct additional apron area northeast of the runway and prepare area to accommodate aircraft tiedowns, hangars, and Fixed-based Operator (FBO) sites;

- Construct internal perimeter access road and install manual gate at Bell Road to access helipad;
- Construct helipad and paint helipad markings on southwest side of runway;
- Remark runway 11-29 to reflect non-precision (GPS based) instrument approach;
- Install Medium Intensity Runway Edge Lights (MIRL);
- Install Runway End Identifier Lights (REILS) and Precision Approach Path Indicator (PAPI) at each runway end;
- Install rotating beacon;
- Light existing wind cones (three wind cones);
- Construct additional apron area northeast of airfield; and
- Replace modular unit with permanent terminal building including pilot lounge, restrooms and airport office space(s).

The ALP identifies two phases of development: Opening (through year 10), which coincides with Phase 1 of CLIBP development and Future, which would occur during Phases 2 and 3 of CLIBP development. The ALP also identifies an “ultimate” airport development scenario that would occur based on user demand. The need for these facilities is not anticipated within the 30-year buildout period and is not included as part of the CLIBP infrastructure financing cost estimate.

As shown in Table 5-1, the estimated cost for airport improvements associated with Phase 1 development is \$4.6 million and for Phase 2 and Phase 3 is \$10.9 million. Including agency/engineering fees and a 25 percent contingency, the possible cost for airport improvements through Phase 3 is \$22.1 million. Any additional Phase 3 improvements will be based on user demand. Initial airport improvements will be made during Phase 1B.

### ***Transportation***

The CLIBP Plan Area is near, but not adjacent to, Interstate Highway 5 (I-5). Access to the Plan Area from I-5 is available from the Fink Road/I-5 interchange to the west and from State Route (SR) 33 to the east. Eighteen roadway segments, three freeway segments, and 30 intersections in and around the Plan Area were studied in the Transportation Infrastructure Plan - Crows Landing Industrial Business Park (Appendix F). To accommodate the full development scenario within the Plan Area, in addition to on-site street requirements, improvements are needed for the Fink Road/I-5 interchange. Off-site roadway improvements and widening, traffic signalization, and bridge crossing improvements are also suggested to facilitate increased traffic flow stemming from both the project and regional growth. Additionally, the County will improve Fink Road between I-5 and Bell Road with a new overlay and striping during Phase 1A to ensure a clean functional south entrance to the CLIBP.

As shown in Table 5-1, the estimated probable cost associated with Phase 1 roadway improvements, including improvements made to the Delta Mendota Canal (DMC) Bridge Crossing and the Fink Road/I-5 interchange is approximately \$29.9 million (\$3.8 million for Phase 1A and \$26.1 million for Phase 1B). Phase 2 roadway improvements are estimated at approximately \$10 million, and Phase 3 at \$26.2 million. Including agency/engineering fees (prorated share of the total cost) and an added 25 percent contingency, the total possible cost for transportation improvements is \$94.2 million. The estimated probable cost would be substantially similar for the potable and nonpotable water infrastructure under all three options, described in detail in the CLIBP Water Supply (Potable & Non-Potable) Infrastructure and Facilities Study (Appendix G).

<b>Table 5-1: Infrastructure Improvement Category Costs by Phase</b>		
<b>Description</b>	<b>Phase 1 Onsite</b>	<b>Phase 1 Offsite</b>
Airport Improvements	\$4,610,000	\$0
Roadways	\$7,258,000	\$6,485,000
DMC Bridge Crossing	\$1,150,000	\$0
Fink Road /I-5 Interchange	\$0	\$15,000,000
Potable Water	\$11,004,000	TBD for connection to CLCSD (Alternative A)
Non-Potable Water	\$7,983,000	\$0
Wastewater/Sewer*	\$21,830,000	\$0
Stormwater Management	\$4,657,000	\$0
Earthwork and Grading	\$267,000	\$135,000
Street Lighting	\$380,000	\$340,000
Traffic Signals and Lighting	\$0	\$3,500,000
Striping and Signage	\$400,000	\$250,000
Right-of-Way Acquisition	\$0	\$837,000
Engineering and Agency Fees****	\$8,084,000	\$3,716,000
Contingency (25%)**	\$5,336,000	\$7,566,000
Contingency (20% for sewer & water)	\$6,557,000	\$0
<b>TOTAL PHASE 1 COSTS</b>	<b>\$79,516,000</b>	<b>\$37,828,000</b>
<b>Description</b>	<b>Phase 2 Onsite</b>	<b>Phase 2 Offsite</b>
Airport Improvements***	\$10,869,000	\$0
Roadways	\$8,492,000	\$1,496,000
Potable Water	\$9,708,000	\$0
Non-Potable Water	\$3,843,000	\$0
Wastewater/Sewer*	\$7,513,000	\$945,000
Stormwater Management	\$699,000	\$0
Earthwork and Grading	\$196,000	\$33,000
Street Lighting	\$360,000	\$84,000
Traffic Signals and Lighting	\$0	\$2,600,000
Striping and Signage	\$400,000	\$400,000
Multimodal Corridor & Green Space	\$1,300,000	\$0
Right-of-Way Acquisition	\$0	\$49,000
Engineering and Agency Fees****	\$6,037,000	\$842,000
Contingency (25%)**	\$6,360,000	\$1,329,000
Contingency (20% for sewer & water)	\$3,495,000	\$227,000
<b>TOTAL PHASE 2 COSTS</b>	<b>\$59,273,000</b>	<b>\$8,004,000</b>
<b>Description</b>	<b>Phase 3 Onsite</b>	<b>Phase 3 Offsite</b>
Airport Improvements	TBD	\$0
Roadways	\$15,237,000	\$10,954,000
Potable Water	\$4,720,000	TBD for connection to Patterson (Alternative C)
Non-Potable Water	\$2,070,000	\$0
Wastewater/Sewer*	\$12,338,000	\$0
Stormwater Management	\$812,000	\$0
Earthwork and Grading	\$327,000	\$96,000
Street Lighting	\$648,000	\$128,000
Traffic Signals and Lighting	\$0	\$2,250,000
Striping and Signage	\$400,000	\$800,000
Right-of-Way Acquisition	\$0	\$669,000
Engineering and Agency Fees****	\$4,125,000	\$2,085,000
Contingency (25%)**	\$4,966,000	\$4,245,000
Contingency (20% for sewer & water)	\$2,024,000	\$0
<b>TOTAL PHASE 3 COSTS</b>	<b>\$47,666,000</b>	<b>\$21,277,000</b>
<b>PROJECT TOTAL</b>	<b>\$186,455,000</b>	<b>\$67,059,000</b>
<i>Costs rounded to nearest \$thousand and may not match totals due to rounding errors</i> * Cost based on conveyance to the City of Patterson for treatment. Refer to discussion of "Wastewater Collection and Treatment" in this section for costs associated with an alternative on-site treatment system. ** Does not include 20% contingency used for sewer and potable and non-potable water *** Airport improvements identified for development years 11-30 in the Airport Layout Plan Narrative Report – Crows Landing Airport (2017)		

**Table 5-1: Infrastructure Improvement Category Costs by Phase**

are identified in Phase 2 to provide a conservative development cost estimate and will be constructed based on demand.  
 \*\*\*\* Civil Engineering and Construction Staking (8%), Agency Plan Checking (1%), and Agency Inspection – Construction Management (5%)

***Water Supply and Distribution***

As described in section 4.3.1 in Chapter 4 (Infrastructure), development of on-site backbone infrastructure for water includes for three options:

- Option 1: extending the Crows Landing Community Services District (CSD) service area to include the CLIBP to enable the development of a shared water system under the CSD’s existing drinking water supply permit;
- Option 2: Obtaining a new water supply permit to enable the County to develop a standalone water supply for the CLIBP, or
- Option 3: extending the City of Patterson’s water service area to include the CLIBP under its existing drinking water supply permit.

Implementation of Alternative B would require the County to supply water and perform all steps necessary to obtain a new permit drinking water permit to CLIBP, including required valuations of nearby systems and the CLCSD and system for the City of Patterson.

Potable water infrastructure includes distribution piping, valves, a water treatment plant at the corner of Bell and Fink Roads, potable water storage tanks, water wells, booster pump stations located adjacent to the potable water storage tanks, and well head treatment systems. Construction of non-potable water infrastructure includes distribution piping, valves, water wells, water well pumps, a non-potable water storage tank, a booster pump station, and fire hydrants.

According to the Crows Landing Industrial Business Park Water Supply (Potable & Non-Potable) Infrastructure and Facilities Study (Appendix G), the preliminary cost estimate for water supply (potable and non-potable) improvements for Phase 1 is approximately \$17.8 million (\$9.0 million for Phase 1A and \$8.8 million for Phase 1B). Cost estimates are \$11.1 million and \$8.0 million for Phases 2 and 3 developments, respectively (see Table 5-1). Including engineering and agency fees and a 20 percent contingency, the total possible cost for the water supply system is \$53.0 million.

***Wastewater Collection and Treatment***

The CLIBP Plan Area will connect to the Western Hills Water District (WHWD), a sanitary sewer effluent conveyance system, which serves the unincorporated community of Diablo Grande located northwest of the Plan Area. The City of Patterson’s Water Quality Control Facility (WQCF), which conveys, treats and disposes of wastewater for Western Hills, would also require improvements to accommodate the addition of Plan Area flows. Wastewater collection backbone infrastructure required as part of Phase 1 improvements include gravity trunk mains, a lift station southwest of Marshall Road and State Route 33, a lift station south of the airfield near the Delta Mendota Canal, and a force main within Marshall Road. The gravity trunk mains and lift station to be constructed in Phase 1A are sized to accommodate ultimate expansion in the Plan Area. Phase 1B and Phase 2 improvements include construction of gravity trunk mains to connect to existing sanitary sewer infrastructure constructed in Phase 1A and 1B, respectively. Phase 3 improvements propose construction of the gravity trunk main system to serve the Phase 3 areas south of Marshall Road.

According to the Crows Landing Industrial Business Park Sanitary Sewer Infrastructure and Facilities Study (Appendix H), the preliminary cost estimate for the wastewater collection system to the City of Patterson,

including commercial and industrial connection fees for Phase 1, is approximately \$21.8 million (\$9.5 million for Phase 1A and \$12.4 million for Phase 1B). Cost estimates are \$8.5 million and \$12.3 million for Phases 2 and 3, respectively (see Table 5-1). Including engineering and agency fees and a 20 percent contingency, the total possible cost for the wastewater collection improvements is \$47.8 million.

As noted in Chapter 4, while the Specific Plan proposes to transport CLIBP effluent to the City of Patterson's wastewater conveyance system for treatment, the existing collection system does not have sufficient capacity to accept the CLIBP Phase 1 flows and known potential developments in the City of Patterson. The process for design, permitting, and construction of expansion of the WQCF could take up to 12 years total. Depending on timing of development in Phases 1 and 2, the County will allow or may need to construct a temporary on-site septic system (temporary package treatment plant or other suitable option) to handle wastewater needs for part, or all, of Phase 1 and part of Phase 2 until the permanent sewer system and ultimate connection to the City of Patterson WQCF has been completed. In the event that the County determines this option is infeasible, the County would develop a plan to provide on-site water treatment through a packaged treatment plant that can be expanded as development of each project phase occurs. Two options for modular package treatment systems: a sequencing batch reactor (SBR) and membrane bioreactor (MBR) are described in Appendix H.

Assuming full capacity build-out, the construction cost opinions would average \$24.5M for the SBR process and \$26.3M for the MBR process, as summarized in Appendix H.

### ***Stormwater Management***

As further provided in the Drainage Study for Crows Landing Industrial Business Park (Appendix I), referred to herein as the Drainage Study, development of the Plan Area will require the construction of new backbone stormwater management and groundwater recharge infrastructure, which will include:

- Raising an approximately 750-foot segment of Davis Road off site and south of the DMC during Phase 1A to protect the area west of the DMC and block flows from ponding in the Plan Area;
- Increasing the capacity of Little Salado Creek during Phase 1B by widening the channel and increasing the capacity of culverts that convey flows beneath the airport runway. Off-site runoff flows would be conveyed to the northeastern corner of the Plan Area through the expanded open channel and culverts; and
- Constructing an on-site stormwater pond in the northeastern portion of the Plan Area beginning in Phase 1B, to detain runoff from Little Salado Creek and allow groundwater recharge.

The estimated cost for stormwater management improvements during Phase 1 is approximately \$4.7 million (\$0.2 million for Phase 1A and \$4.5 million for Phase 1B), and \$0.7 million for Phase 2, and \$0.8 million for Phase 3 (see Table 5-1). Including engineering/agency fees and a 25 percent contingency, the total possible cost for stormwater improvements is \$8.8 million.

In conjunction with the above improvements, other CLIBP build-out infrastructure includes street lighting (approximately \$2.8 million), traffic signals and lighting (approximately \$11.9 million), lane striping and signage (approximately \$3.8 million), earthwork and grading (approximately \$1.5 million), right-of-way acquisition (approximately \$2.2 million), and multimodal (bicycle/pedestrian) transportation corridor/green space (approximately \$1.9 million). Cost estimates, including engineering/agency fees and a contingency, for the infrastructure improvement categories are provided in Table 5-1 by phase.

Phase 1, Phase 2, and Phase 3 represent approximately 47 percent, 25 percent, and 28 percent of the total costs, respectively. On-site infrastructure represents approximately 74 percent of the total infrastructure costs, and off-site infrastructure represents approximately 26 percent of the total infrastructure costs. These preliminary cost estimates were prepared for planning purposes only and are subject to change. The possible cost for CLIBP Plan Area infrastructure development is estimated at approximately \$249.9 million (\$182.9 million on-site improvements and \$67.1 million off-site improvements).

### 5.3.2 CLIBP Financing Plan

The CLIBP Financing Plan (Appendix K) outlines the requirements for construction of infrastructure necessary to implement the goals and vision of the CLIBP Specific Plan and potential financing mechanisms and funding sources to finance the backbone infrastructure and public facilities. The Financing Plan provides detailed cost estimates for the various infrastructure requirements by land use within the Plan Area and by development phase. In summary, the Financing Plan addresses the following:

- Briefly describes the CLIBP project and phasing of needed infrastructure;
- Provides a summary of the infrastructure and public facility requirements to serve future development within the Plan Area;
- Includes infrastructure cost estimates by land use and by development phase per acre, and the estimated infrastructure cost at build-out of the CLIBP;
- Presents cost estimates for operating and maintaining the required infrastructure and for ongoing municipal services;
- Identifies potential funding sources for both the construction of infrastructure and provision of municipal services;
- Sums the overall cost burden by land use and by development phase per acre; and
- Provides recommended action steps for implementation of infrastructure financing.

The CLIBP Financing Plan will serve as a framework to guide and support the objectives of the CLIBP Specific Plan. As development progresses, the timing and mix of cost and funding sources may change. The assumptions and results are estimates at this time, and actual results could vary. Regardless of the extent to which certain financing mechanisms are used or funding sources are available, the overall cost burden has been calculated for the purpose of determining most appropriate and feasible financing strategies and mechanisms to proceed with development under the Specific Plan.

This page intentionally left blank.



CROWS LANDING LAND USE AND  
EMPLOYMENT SUMMARY

---

App.  
A



TABLE A-1: CROWS LANDING INDUSTRIAL BUSINESS PARK LAND USE AND EMPLOYMENT SUMMARY					
Developable Land Use By Phase	Developable Acres	Floor-Area Ratio [1]	Building Area (per KSF) [2]	Employees (per KSF)	Total Employees
<b>PHASE 1 (764 Acres)</b>					
<b>Phase 1A:</b>					
<b>Fink Road Corridor</b>					
Logistics/Distribution	52	0.35	785	0.35	275
Light Industrial	41	0.35	628	0.97	609
Business Park	10	0.35	157	2.80	440
<i>Phase 1A: Fink Road Corridor Subtotal</i>	<b>103</b>		<b>1,570</b>		<b>1,324</b>
<b>Phase 1B:</b>					
<b>Bell Road Corridor</b>					
Logistics/Distribution	138	0.35	2,104	0.35	736
Light Industrial	110	0.35	1,683	0.97	1,633
Business Park	28	0.35	421	2.80	1,178
<i>Bell Road Corridor Subtotal</i>	<b>276</b>		<b>4,208</b>		<b>3,547</b>
<b>Airport - Phases 1 through 3 (Part of Phase 1 Infrastructure)</b>	<b>370</b>	<b>NA</b>	<b>NA</b>	<b>NA</b>	<b>1</b>
<b>Public Facilities</b>	<b>15</b>	<b>0.25</b>	<b>163</b>	<b>2.80</b>	<b>457</b>
<i>Phase 1B Subtotal</i>	<b>661</b>		<b>4,371</b>		<b>4,006</b>
<b>PHASE 1 TOTAL</b>	<b>764</b>		<b>5,941</b>		<b>5,329</b>
<b>PHASE 2 (236 Acres)</b>					
<b>SR 33 Corridor (South)</b>					
Logistics/Distribution	57	0.40	990	0.69	683
Light Industrial	71	0.40	1,237	0.97	1,200
Business Park	14	0.40	247	2.80	693
<i>SR 33 Corridor (South) Subtotal</i>	<b>142</b>		<b>2,474</b>		<b>2,576</b>
<b>Aviation Related</b>	<b>46</b>	<b>0.40</b>	<b>802</b>	<b>0.35</b>	<b>281</b>
<b>Multimodal Trans. Corridor / Green Space</b>	<b>13</b>	<b>NA</b>	<b>NA</b>	<b>NA</b>	<b>2</b>
<b>Public Facilities</b>	<b>35</b>	<b>0.25</b>	<b>381</b>	<b>2.80</b>	<b>1,067</b>
<b>PHASE 2 TOTAL</b>	<b>236</b>		<b>3,657</b>		<b>3,926</b>
<b>PHASE 3 (274 Acres)</b>					
<b>SR 33 Corridor (North)</b>					
Logistics/Distribution	102	0.40	1,784	0.69	1,231
Light Industrial	128	0.40	2,230	0.97	2,163
Business Park	26	0.40	446	2.80	1,249
<i>SR 33 Corridor (North) Subtotal</i>	<b>256</b>		<b>4,460</b>		<b>4,643</b>
<b>Public Facilities</b>	<b>18</b>	<b>0.25</b>	<b>196</b>	<b>2.80</b>	<b>549</b>
<b>PHASE 3 TOTAL</b>	<b>274</b>		<b>4,656</b>		<b>5,192</b>
<b>GRAND TOTAL</b>	<b>1,274</b>		<b>14,254</b>		<b>14,447</b>

**Notes:**

[1] Floor Area Ratio (FAR) is the ratio of a building's total floor area (gross floor area) to the size of the lot upon which it is built.

[2] Kilo (1,000) Square Feet (KSF)

**Assumptions:**

1. Land Use. The land use breakdown varies based on the following development patterns:
  - a. Fink Road and Bell Road Corridors: Assumes approximately 50% logistics/distribution use, 40% light industrial use, and 10% business park/office use.
  - b. SR 33 Corridor: Assumes approximately 40% logistics/distribution use, 50% light industrial use, and 10% business park/office use.
2. Public Facilities. The estimated number of potential employees in this area is conservative and based on the following assumptions:
  - a. A variety of municipal office, professional office, work force training, worker amenities, and other uses are envisioned.
  - b. A conservative estimate of 350/SF per person was assumed as an average based on a range of uses and the Stanislaus County Airport Land Use Compatibility Plan, which assumed dense use in this area.
3. The 0.35 to 0.40 FAR is consistent with other business parks in the region, as well as nearby Patterson and Beard (Modesto) industrial areas.
  - a. A FAR of 0.40 was used in the SR 33 Corridor and aviation-related uses.
  - b. A FAR of 0.35 was used in the Fink Road and Bell Road Corridors.
  - c. A FAR of 0.25 was applied to the Public Facilities Area.
4. Logistics Use. Calculations varied north and south of the area based on site layout considerations and historic local development patterns.
  - a. For the SR 33 Corridor, a factor of 0.69 employee/KSF was used to reflect historic development patterns at the Beard industrial site in Modesto.
  - b. For the Bell Road and Fink Road Corridors, a factor of 0.35 employee/KSF was used to reflect historic development patterns at the nearby Patterson Industrial Park.
  - c. Calculations for actual site absorption rates were provided by the Stanislaus Work Force Alliance in June 2014.
5. Industrial Uses. Calculations are based on a factor of one employee/KSF as it represents the mean identified for the Beard industrial tract in June 2014. (The number of employees/KSF at the Beard tract ranged from 0.43/KSF to 1.08/KSF)
6. Business Park Uses. A rate of 350 SF/employee or 2.80 employees/KSF was used site-wide.
7. Absorption/Phasing. An approximately 30-year development period is anticipated as follows:
  - a. Phase 1 = 5,609 employees
  - b. Phase 2 = 3,645 employees
  - c. Phase 3 = 5,192 employeesTOTAL = 14,447 employees

CROWS LANDING PERMITTED LAND  
USES AND DESIGN AND  
DEVELOPMENT STANDARDS

---

App.  
**B**



## B.1 PERMITTED LAND USES

Table B-1 identifies the list of land uses permitted within the Crows Landing Industrial Business Park (CLIBP) Specific Plan area (Plan Area). The specific uses in Table B-1 correspond to the broader land use categories identified in the Specific Plan, subject to compliance with adopted design and development standards. A proposed land use that is not identified as permitted in Table B-1 may be allowed if it is determined by the Planning Director, or his/her designee, to be similar in nature to a permitted use and is consistent with the Stanislaus County Airport Land Use Compatibility Plan (ALUCP). Any use that is identified to pose a hazard to aircraft operations shall be prohibited.

<b>Table B-1: CLIBP S-P(2) Zone Permitted Use Table[1]</b>			
	<b>P</b>	<b>Permitted Use</b>	
	<b>SAA</b>	<b>Staff Approval Application Permit Required</b>	
	<b>[#]</b>	<b>Refer to Notes Below</b>	
<b>Land Use Category</b>	<b>Land Use Area</b>		
	<b>Airport-Related [2]</b>	<b>SR 33, Bell Road, and Fink Road Corridors</b>	<b>Public Facilities</b>
<b>AGRICULTURE AND OPEN SPACE USES</b>			
Animal grazing [3]	P	P	P
Crop production and horticulture [3]	P	P	P
Parks and open space [4]	-	P	P
Bicycle/pedestrian path	-	P	P
<b>AVIATION-RELATED</b>			
Air cargo and parcel delivery facilities	P	-	-
Aircraft services and facilities (e.g., repair and maintenance, parking, storage, medevac)	P	-	-
Auxiliary support facilities for on-airport services that do not require direct airfield access (e.g., offices, passenger and pilot lounge, emergency services)	P	-	P
<b>LIGHT INDUSTRY, MANUFACTURING &amp; PROCESSING USES [5]</b>			
Assembly of products	P	P	-
Business equipment assembly, services, and sales	P	P	SAA
Computer systems research and development	P	P	P
Container/package shipping and storage	P	P	-
Corporate offices	P	P	P

<b>Table B-1: CLIBP S-P(2) Zone Permitted Use Table[1]</b>			
<b>P</b>	<b>Permitted Use</b>		
<b>SAA</b>	<b>Staff Approval Application Permit Required</b>		
<b>[#]</b>	<b>Refer to Notes Below</b>		
<b>Land Use Category</b>	<b>Land Use Area</b>		
	<b>Airport-Related [2]</b>	<b>SR 33, Bell Road, and Fink Road Corridors</b>	<b>Public Facilities</b>
Distribution and storage [6]	P	P	-
Furniture manufacturing	P	P	-
Electronic repair and assembly	P	P	-
General food manufacturing and processing [7]	SAA	SAA	-
Machine shop	P	P	-
Packaging	P	P	-
Pharmaceutical manufacturing	P	P	-
Printing and publishing companies, book binding	P	P	-
Recycling facility [8]	SAA	SAA	-
Research and development [7]	P	P	P
Seed processing and packaging	P	P	-
Sheet metal fabrication	P	P	-
Software development	P	P	P
Technology manufacturing and support industries [7]	P	P	-
Warehouses as a principle use	P	P	-
<b>SERVICE USES</b>			
Broadcast studios, communication facilities [9]	P	P	P
Call centers	P	P	P
Copying and reprographics service	P	P	P
Education/training facilities	P	P	P
Offices	P	P	P
Parcel delivery service	P	P	P
Vehicle rental	P	P	P



<b>Table B-1: CLIBP S-P(2) Zone Permitted Use Table[1]</b>			
<b>P</b>	<b>Permitted Use</b>		
<b>SAA</b>	<b>Staff Approval Application Permit Required</b>		
<b>[#]</b>	<b>Refer to Notes Below</b>		
<b>Land Use Category</b>	<b>Land Use Area</b>		
	<b>Airport-Related [2]</b>	<b>SR 33, Bell Road, and Fink Road Corridors</b>	<b>Public Facilities</b>
<b>PUBLIC FACILITY USES</b>			
Emergency services (i.e., law enforcement, fire protection)	P	P	P
Medical office/clinic[10]	P	P	P
Government services	P	P	P
Public utilities and services	P	P	P
Transit center	P	P	P
<b>ACCESSORY USES</b>			
Worker amenities (e.g., fitness center, coffee shop, daycare, ATM)[11]	SAA	SAA	SAA
<b>Notes:</b>			
<p>[1] All permitted uses are subject to compliance with adopted design and development standards and must be consistent with the Stanislaus County Airport Land Use Compatibility Plan (ALUCP). Any use not defined as permitted shall not be allowed unless determined by the Planning Director, or his/her designee, to be similar in nature to a permitted use. Any use determined to pose a hazard to aircraft operation shall be prohibited.</p> <p>[2] The Airport-Related Area permits all business park, light industrial, logistics/warehousing, and public facility uses, but the proximity of this area to the airport can provide benefits for some users. In recognition of the proximity benefit, uses in the Airport-Related Area shall be restricted to uses determined by the County to be an aviation-related use, during the first five years of area development.</p> <p>[3] Existing agricultural uses may be permitted to continue until the area is required for the development of infrastructure or another allowed use.</p> <p>[4] Limited to small/low density non-group use/gatherings, except for the Public Facilities Area air tower greenspace/park, which may be used for larger civic gatherings.</p> <p>[5] All manufacturing and processing must be conducted entirely within an enclosed building.</p> <p>[6] Includes wholesale distribution when not open to or advertised to the general public.</p> <p>[7] Subject to the County determining water usage is low volume, not exceeding Specific Plan water usage assumptions.</p> <p>[8] Excluding scrap metal and common household recycling (e.g., plastic bottles, cans, batteries). The County will consider e-waste recycling (e.g., electronics) when conducted entirely within an enclosed building.</p> <p>[9] Subject to the County determining that the equipment to be used and transmissions do not have the potential for interference with airport operations.</p> <p>[10] Limited use, outpatient clinic (e.g., urgent care facility), no overnight facilities.</p> <p>[11] Permitted when ancillary to primary use of building.</p>			

## B.2 DESIGN AND DEVELOPMENT STANDARDS

The purpose of the CLIBP design and development standards is to guide development of the Plan Area, in accordance with the goals and policies of the Specific Plan. The design and development standards shall be used to assist tenants/developers/contractors, County staff, and others during the preparation and review of development proposals within the Plan Area. The standards are intended to provide direction to support the

creation of an attractive, high-quality industrial business park while optimizing flexibility to plan and design for specific functional needs.

The CLIBP design and development standards are intended to complement adopted countywide standards, while recognizing the unique context of the CLIBP. An important condition of Plan Area development is the County's ongoing ownership of the land and plan to enter into long-term property leases with prospective tenants and/or to develop the property in partnership with a Master Developer. The CLIBP design and development standards recognize that a coordinated public-private partnership approach and comprehensive planning are essential to the phased development of the Plan Area.

The County shall enforce the provisions of these design and development standards in order to implement the policies of the Specific Plan and all applicable codes, including, but not limited to: building, mechanical, fire, and electrical codes and codes addressing stormwater management, wastewater, public utilities, and grading.

For purposes of these standards, the term "leasehold" shall have the same meaning as a "lot," as defined by Title 21 of the County Code, for the purpose of establishing compliance with design and development standards. Adjoining leaseholds held by the same person and/or entity shall be considered as individual lots, if developed independently. In the event that a project site is composed of multiple lots, development standards such as setbacks, landscaping, and fencing shall be determined by the perimeter boundary of the project site.

### **B.2.1 Applicability and Use of the Design and Development Standards**

The CLIBP design and development standards shall apply to all development within the Plan Area and contain both mandatory requirements and more discretionary, yet specific, design guidance allowing for flexibility in achieving the objective or intent of a particular standard. Mandatory requirements use the words: "shall" and "will." Standards containing words, such as "encouraged" or "may" are advisory guidelines for development. "Should" statements mean an action is required, unless the intent of the standard is satisfied through other means.

The CLIBP design and development standards establish the base or minimum requirements for development of the Plan Area. Builders and developers may, in some instances, be required to meet more than the minimum standards, including, but not limited to implementation of environmental mitigation measures. During the site plan review process, County staff will review project proposals for compliance with these standards and with all other applicable countywide standards and environmental mitigation measures. The Planning Director shall have the authority to interpret these standards and to condition the approval of any project within the Plan Area. Proposed exceptions to these standards or amendments to the Specific Plan may be permitted as described in Chapter 5, "Specific Plan Implementation," of the Specific Plan.

### **B.2.2 Design and Development Standards Structure**

The CLIBP is a mixed-use industrial business park, designed to support a variety of aviation-compatible light industrial, logistics, warehouse, distribution, and office uses, as well as a general aviation airport. The design and development framework in Chapter 3, "Built Environment and Design," of the CLIBP Specific Plan establishes the goals and policies for future development within the Plan Area and is intended to support high-quality design and development of the CLIBP.

The design and development standards for the CLIBP are detailed and organized into the following general sections:

- B.3 General Performance Standards
- B.4 Development Standards by Land Use
- B.5 Site Planning Standards
- B.6 Streetscape/Landscape Standards
- B.7 Building and Architectural Standards
- B.8 Parking Standards
- B.9 Signage Standards
- B.10 Property Maintenance Standards

### **B.3 GENERAL PERFORMANCE STANDARDS**

All land uses within the Plan Area shall be operated and maintained in compliance with the following minimum performance standards so as not to be injurious to public health, safety, or welfare:

**Air Emissions.** No use shall generate or cause any visible dust, gasses, or smoke to be emitted into the atmosphere, except as necessary for the heating or cooling of structures and the operation of motor vehicles on the site. Emissions must not interfere with visibility or produce a heat plume that would interfere with aviation/safe aircraft operation. This requirement also applies to the disposal of trash and waste materials.

**Glare and Heat.** No direct or sky-reflected glare or heat, whether from floodlights or from high temperature processes (including combustion or welding) shall be visible or felt at the lot boundary, including when permitted in an enclosed or screened area, nor shall glare or heat interfere with aircraft operations.

**Noise.** No use shall generate noise that causes the exterior noise level to exceed the noise level standards set forth in the Stanislaus County Code, with the exception of temporary noise activities. Exposure to aircraft noise, including criteria for interior noise levels, is presented in the Stanislaus County ALUCP.

**Ground Vibration.** No use shall generate ground vibration, perceptible without instruments, at any point along or outside of the lot boundary, except for motor vehicle operations or for temporary construction activities, as regulated by Stanislaus County Code.

**Odors or Fumes.** No use shall generate or emit any odor or fumes perceptible at the lot boundary.

**Waste or Other Harmful Substances.** No use shall discharge waste or any harmful substance, as defined by the Stanislaus County Code, into any public sewer or storm drainage system. All waste shall be handled in compliance with all applicable federal, state, and local regulations.

In addition to those performance standards listed above, all land uses within the Plan Area shall be subject to nuisance standards of the County's Zoning Ordinance, including those established to remedy a nuisance, and any stricter standard applied by discretionary permit.

### **B.4 DEVELOPMENT STANDARDS BY LAND USE**

The development standards provided in Table B-2 are applicable to each of the CLIBP Specific Plan land use categories. Refer to Sections B.5 through B.10 for additional information and design and development standards.

<b>Table B-2: Development Standards by Land Use</b>					
<b>Development Standards</b>	<b>Land Use Categories</b>				
	<b>Aviation-Related</b>	<b>Logistics/Warehousing</b>	<b>Light Industrial</b>	<b>Business Park</b>	<b>Public Facilities</b>
<b>Lot Standards</b>					
Maximum Lot Coverage (percent) [1] [2]	50%	50%	50%	50%	50%
Minimum Lot Area	1 acre	5 acres	5 acres	5 acres	1 acre
<b>Yard Standards (in feet)</b>					
Front Yard and Side Yards of Corner Lots on Internal Roadways [3][4]	15 feet	15 feet	15 feet	15 feet	15 feet
Front Yard and Side Yard of Corner Lots on External Roadways [3][4]	25 feet	25 feet	25 feet	25 feet	25 feet
Side Yard, Interior	[5]	[5]	[5]	[5]	[5]
Rear Yard	[5]	[5]	[5]	[5]	[5]
Front, Side, or Rear Yards Adjacent to Off-Site Agricultural or Residential Uses [6]	150 feet	150 feet	150 feet	150 feet	150 feet
<b>Other Development Standards</b>					
<b>Maximum Height Limit (in feet) [7]</b>	45[7]	45[7]	45[7]	45[7]	45[7]
<b>Driveways, Loading and Service Areas</b>	Refer to standards in Sections B.5.3 and B.5.4, that follow.				
<b>Landscaping</b>	Refer to standards in Sections B.6.1 through B.6.3, that follows.				
<b>Lighting</b>	Refer to standards in Section B.6.5, that follows.				
<b>Parking</b>	Refer to standards in Section B.8, that follows.				
<b>Signage</b>	Refer to standards in Section B.9, that follows.				
<b>Notes:</b>					
[1] Lot coverage shall be determined by the total square footage of all the footprints of all the structures on a lot divided by the gross lot area.					
[2] Greater lot coverage may be permitted, subject to meeting minimum development standards, including but not limited to parking, landscaping, and storm drainage; however, in no case shall more than 75% lot coverage be permitted without approval of a use permit.					
[3] Yards shall be measured from the edge of the ultimate roadway right-of-way adjoining the lot, as identified by the CLIBP Specific Plan or the Circulation Element of the Stanislaus County General Plan.					
[4] Vehicle openings of any building shall be setback an additional 20-feet.					
[5] To be governed by the Uniform Building Code and Fire Code for use or occupancy and type of construction.					
[6] Yard setbacks shall be measured from the edge of the ultimate roadway right-of-way, as identified by the Specific Plan or the Circulation Element of the Stanislaus County General Plan, closest to the off-site agricultural or residential use when separated by an external roadway, provided the setback is equal to or greater than any other required yard.					
[7] The maximum building height measurement is 45 feet to the top of the building parapet, with an additional 5-feet allowed for architectural projections, special equipment, mechanical devices, and other appurtenances. A maximum building height of 60 feet may be approved by the Planning Director, or his/her designee, on a case-by-case basis following airspace review. All structures and appurtenances shall comply with policies associated with navigable airspace as identified in the Stanislaus County Airport Land Use Compatibility Plan (ALUCP).					

## B.5 SITE PLANNING STANDARDS

Site planning standards ensure that site designs are efficient, convenient, and safe for multiple modes of transportation, while providing attractive frontages, landscaping, and outdoor spaces. These standards also enhance the aesthetic quality of the CLIBP and promote a sense of place.

### **B.5.1 Building Height Standards**

#### ***Standards***

1. Exception to building height limits specified in Table B-1 (Note 7) may be granted by the Planning Director, or his/her designee, upon making all the following findings:
  - a. The exception will not constitute a grant of special privilege inconsistent with the goals and policies of the CLIBP Specific Plan.
  - b. The exception will not adversely affect the health, safety, or general welfare of persons working or residing in the vicinity.
  - c. The exception is consistent with the navigable surfaces identified in the Stanislaus County ALUCP and shall not constitute an obstruction to navigable airspace.

### **B.5.2 Local Industrial Road Design Standards**

Local industrial roads shall be constructed of concrete pavers and employ various surface treatments to distinguish pedestrian and bicycle facilities from vehicular travel lanes.

### **B.5.3 Driveway Design Standards**

Driveways shall be carefully located so as not to impede the primary function of roadway rights-of-way to circulate traffic. The Stanislaus County Department of Public Works (SCDPW) will approve the location of all driveways.

#### ***Standards***

1. Individual lots on minor arterial streets may have driveways, but they shall be located so as not to impede traffic efficiency. In general, lots with frontage on minor arterial streets shall site their entryway on internal side streets wherever possible. If the only frontage is on the major frontage or access street, every effort shall be made to consolidate access at a single driveway.

Spacing standards for driveways on local industrial roads street shall be as follows:

- a. Full access driveways, 250-foot minimum.
- b. Right-in/right-out driveways, 200-foot minimum from the end of the curb radius at an intersection, for driveways located both upstream and downstream from intersections.
2. Driveways shall be a minimum of 35 feet wide. Subsequent development shall demonstrate that the driveway width and placement can accommodate truck turning movement and clearing without blocking roadways.
3. Access driveways shall provide adequate length to accommodate off-street vehicle stacking needs during times of peak use, as determined and approved by the Public Works Director or his/her designee.
4. Driveways shall be prohibited on W. Marshall, Fink, Bell, and Davis Roads. Access for these lots shall be through internal circulation streets.
5. Multiple driveways may be allowed on large lots for the purpose of separating automobile/employee traffic from truck traffic. In no case shall driveways on the same lot be less than 250 feet from each other.

#### **B.5.4 Loading and Service Area Design Standards**

Functional loading and service areas are critical to CLIBP users whose operations involve frequent truck traffic or facilities that may need to handle chemicals or other controlled materials. Service areas include delivery and loading zones, trash disposal areas, and space for mechanical equipment.

##### ***Loading Area Design Standards***

1. Loading areas, including loading docks and doors, should be placed to the side or rear of the buildings and provided with adequate screening from nearby public areas. Where it is not possible to locate loading areas to the side or rear of a building, loading areas shall be permitted if they are set back a minimum of 125 feet from the curb, do not dominate the building frontage, and screened from public view by landscaping, berms, and/or fences.
2. Buildings, structures, and loading facilities shall be designed and placed to provide adequate space for vehicles, whether rear loading or side loading, to load or unload at any loading dock, door, or area, without extending beyond the lot boundary. For loading docks designed to accommodate large delivery trucks, a minimum of 85 feet shall be provided from the the edge of the loading dock to the far edge of the maneuvering area. All other loading docks or areas shall be reviewed by the Public Works Director, or his/her designee, for adequate maneuvering area.
3. Loading space shall be provided in addition to and shall not encroach into required parking spaces or driveways.

##### ***Service Areas Design Standards***

1. All types of exterior storage should be confined to portions of the lot that are least visible from public view.
2. Trash enclosures shall be located and designed so as not to impede on-site circulation or required parking.
3. Unless fully enclosed, storage areas shall be set back a minimum of 50 feet from public streets.
4. All exterior trash, storage, and service areas shall be screened from public view with a wall or fence in accordance with the standards for screening provided in Section B.5.5.
  - a. Shipping containers and other portable containers may be temporarily stored in these areas, but they may not be stacked on top of each other. Temporarily means that these items shall not be stored on site after their useful purpose is completed.
  - b. All trash receptacles and containers must remain covered at all times and storage areas closed when not in use.
5. Roof-mounted mechanical equipment shall be screened from street view. Transformers, emergency generators, utility connections, and meter boxes shall be disguised to blend in with the surrounding landscape elements or screened from public view, as guided by the standards for walls and screening elements provided in Section B.5.5.

### B.5.5 Walls and Screening Elements

1. Where screening is required, a combination of elements should be used, including solid masonry walls, landscaping, and berms.
  - a. Landscaped screening shall be required in front of walls, unless the wall is determined by the Planning Director, or his/her designee, to be of an architectural design not requiring landscaping.
  - b. The screening design shall be architecturally compatible with the adjacent building with respect to materials, colors, and size and complement the project or site's overall landscape design.
2. Walls or fences shall be required as a means of screening when landscaping materials alone do not provide adequate screening for the intended use or purpose.
3. Wall or fence elements shall be designed in accordance with the following standards:
  - a. Walls or fences required for screening of loading, trash, or service areas shall be a minimum of 8 feet high and constructed of the same or similar materials as the adjacent building.
  - b. Masonry or landscaped walls constructed along the front yard areas shall not exceed 36 inches in height and shall be designed not to impair traffic safety by obscuring views.
  - c. The design of security fences shall be approved by the Planning Director or his/her designee. Barbed wire and razor wire shall be prohibited, unless approved by the Planning Director or his/her designee.
4. Any mechanical or utility equipment, whether on the roof, side of building, or ground, shall be disguised with coordinating paint materials that blend in with the site's overall landscape design and/or screened by walls, enclosures, or dense landscaping.
  - a. Screening elements, if provided, shall fully surround the equipment being screened.
5. Screening for outdoor storage should be determined by the height of the material being screened.
6. Chain-link fence should be used sparingly, only where needed; however, with wood slats approved by the Planning Director or his/her designee, is an acceptable screening material for areas not visible from the public street.

## B.6 STREETScape / LANDSCAPE STANDARDS

### B.6.1 Landscape Requirements

All landscaping shall comply with County Code Section 21.61.080, "Landscape Area Requirements," Section 3.3.2 (see Chapter 3) of the CLIBP Specific Plan, and the following general landscape design standards.

#### *Standards*

1. **Setbacks.** All yard areas required by this chapter, easements for utilities, and drainage courses shall be landscaped, except where a required yard is screened from public view or it is determined by the Planning Director, or his/her designee, that landscaping is not necessary to fulfill the purposes of this chapter.
  - a. Yards located along the Plan Area perimeter shall be landscaped with a consistent landscape pattern.
  - b. Landscaping must not provide habitat for wildlife that is potentially hazardous to aviation.

2. **Unused Areas.** All areas of a lot not intended for a specific use, including pad sites held for future development, shall be landscaped unless it is determined by the Planning Director that landscaping is not necessary to fulfill the purposes of this chapter.
3. **Parking Areas.** Parking areas shall include landscaping in compliance with the following requirements.
  - a. **Landscape Materials.** Landscaping materials shall be provided throughout the parking lot area, using a combination of trees, shrubs, and ground cover. Drought-tolerant and native plant materials are preferred. The use of turf is prohibited.
  - b. **Curbing.** Areas containing plant materials shall be bordered by a concrete curb at least 6 inches high and 6 inches wide. Alternative barrier design may be approved by the Planning Director or his/her designee if these alternative designs protect landscaped areas from damage by vehicles and curb cuts in the concrete allow for stormwater management planters.
  - c. **Location of Landscaping.** Parking lot landscaping shall be located so that pedestrians are not required to cross landscaped areas to reach building entrances from parked cars. This should be achieved through proper orientation of landscaped fingers and islands.
  - d. **Bumper Overhang Areas.** To increase the parking lot landscaped area, a maximum of 2 feet of the parking stall depth may be landscaped with low-growth, hearty materials in lieu of paving, allowing a 2-foot bumper overhang while maintaining the required parking dimensions.
  - e. **Perimeter Parking Lot Landscaping.**
    - [1] **Adjacent to Streets.** Parking lots adjacent to, and visible from, public streets must be adequately screened from view through the use of rolling earth berms, low screen walls, appropriate landscaping, or combinations thereof, whenever possible.

Parking lots adjacent to a public street shall be designed to provide a landscaped planting strip between the street right-of-way and parking area equal in depth of the required yard area or fifteen feet, whichever is more.

The landscaping shall be designed and maintained to screen parked cars from view from the street to a height of 36 inches. Screening materials may include a combination of plant materials, earth berms, solid masonry walls, raised planters, or other devices that meet the intent of this requirement. Shade trees with a maximum mature height of 45 feet shall be provided at a minimum spacing of one for every 40 linear feet of landscaped area. Plant materials, signs, or structures shall be avoided within a traffic safety sight area of a driveway.
    - [2] **Adjacent to Side or Rear Lot Lines.** Parking areas shall provide a perimeter landscaped strip of at least 5 feet wide (inside dimension) where the parking facility adjoins a side or rear lot line. The perimeter landscaped strip may include a required yard area. Shade trees with a maximum mature height of 45 feet shall be provided at a minimum spacing of one for every 40 linear feet of landscaped area.
  - f. **Interior Parking Lot Landscaping**
    - [1] **Amount of Landscaping.** All development shall provide landscaping within the parking area at a minimum ratio of six percent of the gross area of the parking lot. One tree shall be provided for every ten parking spaces.



- (a) **An exception to the parking area landscape standard** may be granted by the Planning Director, or his/her designee, when parking spaces will be covered for the purposes of accommodating solar arrays, provided:
- (i) A landscape plan illustrating the site's ability to accommodate the required landscaping at a future date is reviewed and approved as part of the initial site plan review.
  - (ii) Approved landscaping shall be installed in any area where a solar array is removed, to the extent that the landscaping will not shade any remaining solar arrays within three months of solar array removal.
  - (iii) That the structure upon which the solar array is placed be located outside of a required front, side, or rear yard and be setback a minimum of 25 feet from any lot boundary.
  - (iv) All solar arrays are evaluated by staff to determine whether they are compatible with aviation (e.g., type of solar facility proposed, potential to produce glare, etc.).

[2] **Location of Landscaping.** Landscaping shall be evenly dispersed throughout the parking area. Use of an orchard-style planting scheme (placement of trees in uniformly-spaced rows) is encouraged for larger parking areas with more than one hundred spaces. All parking lots should provide a concentration of landscape elements at primary entrances, including specimen trees, flowering plants, enhanced paving, and project identification.

[3] **Adjacent to Structures.** When parking areas are located adjacent to structures, a minimum 5-foot wide landscape strip shall be provided adjacent to the structure.

**Drainage Areas, Detention Basins, and Bioswales.** Dry detention basins, bioswales, and other low impact development features are encouraged on individual lots to reduce stormwater runoff.

All surface drainage facilities shall be landscaped to the extent possible. Plant materials shall be chosen that are tolerant of periodically wet conditions and that provide an attractive appearance during long periods when no water is present.

**Design for Airport Compatibility.** Landscaped areas shall be designed not to create habitat for wildlife that could conflict with aviation activities.

- a. Landscape materials shall not include a food source for birds or wildlife, such as fruit, nuts, berries, drupes, etc.
- b. Groundcover shall be maintained at an intermediate height of 6 to 12 inches to avoid the creation of nesting opportunities or shelter for birds or other wildlife.
- c. Street trees shall be low-growing varieties with a maximum mature height of 45 feet to prevent conflicts with navigable air space, and spaced at 40-foot intervals to prevent the creation of potential nesting and roosting sites and to prevent the creation of a continuous canopy. The Planning Director or his/her designee, upon a showing by the applicant that the intent of this airport-compatibility design standard is achieved, may approve exceptions to these standards.

## B.6.2 General Planting Design

### *Standards*

1. A mix of drought-tolerant or climate appropriate shrubs and groundcover should be used to facilitate compliance with state and County landscape standards. Applicants shall demonstrate compliance with these requirements by submitting a Landscaping and Tree Planting Plan per Chapter 21.102 of the Stanislaus County Code (Refer to the recommended plant palette for the Plan Area, provided in Chapter 3, “Built Environment and Design,” of the CLIBP Specific Plan, for examples of California native and climate appropriate plants and trees). Applicants should also consider guidance from organizations such as the California Native Plant Society or University of California Cooperative.
2. Proposed landscape designs must not create habitat by providing a food source or nesting and perching opportunities for wildlife that could conflict with on-site aviation (Refer to the recommended plant palette for the Plan Area, provided in Chapter 3, “Built Environment and Design,” of the CLIBP Specific Plan).
3. Landscape plantings shall be grouped according to similar water needs.
4. Climate appropriate landscaping should be used, where feasible, with permeable or porous pavement and to treat and attenuate stormwater flows and reduce stormwater runoff.
5. Lawns and turf grass areas shall not be used within the Plan Area.
  - a. Groundcovers should be used, such as mulch or flower planting beds and naturalized groundcover, including native grasses and shrubs that will not be attractive to wildlife.
  - b. A variety of non-living groundcovers should be used, such as bark, cobble, and larger stones, to supplement the primary groundcover and, thereby, reduce maintenance and irrigation.

Low volume irrigation equipment shall be required for all planting areas within individual lots.

## B.6.3 Landscape Maintenance

All landscaping must be maintained in accordance with the following standards:

### *Standards*

1. All landscaped areas shall be maintained in a healthful and sound condition at all times. Irrigation systems and their components shall be maintained in a fully functional manner consistent with the originally approved design and the provisions of these standards. Regular maintenance shall include checking, adjusting, and repairing irrigation equipment; resetting automatic controllers; adding/replenishing mulch, fertilizer, and soil amendments; pruning; and weeding all landscaped areas.

Water waste resulting from inefficient landscape irrigation leading to excessive runoff, low head drainage, overspray, and other similar conditions where water flows onto adjacent property, non-irrigated areas, walks, roadways, or structures is prohibited.

## B.6.4 Site Furnishings

Site furnishings (including benches, covered trash receptacles, bollards, planters, bus shelters, and other similar features) should be provided within the public realm and common or public use areas of properties, to

activate the walkways linking adjacent properties and support the creation of a more pedestrian-friendly campus work environment, where appropriate, particularly within the business park and public facilities areas.

### ***Standards***

1. Street furnishings and landscaping, including planters and potted plants, shall be provided along walkways and common open spaces in both public and private realms to enhance the pedestrian experience and encourage spontaneous gatherings.
2. Street furnishing selected should complement the design themes within the Plan Area and shall be easy to maintain, high quality, and vandal resistant.
3. Outdoor furnishings shall be compatible with the design aesthetics, material quality, and colors of the site development and with site lighting choices chosen for the Plan Area. When possible, outdoor furnishing shall be coordinated.
4. A common overall theme, material, and color palette should be used for furnishings, including seating areas, trash receptacles, tree grates, and bollards, to create a cohesive look.
5. Outdoor furnishings should be compatible with the design aesthetics, material quality, and color of building exteriors.
6. Outdoor areas designated for employee breaks or eating areas should be equipped with covered trash receptacles and signs to prohibit the feeding of wildlife.

### **B.6.5 Site and Property Lighting**

Lighting within the Plan Area should be designed to create safe and secure environments and to help reinforce the character of the industrial business park and the appearance of buildings. Lighting within a development should be consistent and uniform, using recommended lighting standards. Lighting may consist of a variety of types and styles designed to illuminate the intended surfaces or spaces, avoid light spillover and glare into surrounding areas, and reduce night-sky pollution.

### ***Standards***

1. Lighting shall be designed and placed to direct lighting to appropriate surfaces and to minimize glare into adjacent areas.
2. Lighting shall be used to provide illumination for security and safety of parking, loading, and service access areas.
3. Lighting shall be shielded (with full cut off designs) and directed downward to keep light spread within the project's property boundaries. The light bulb of an exterior light fixture shall not be visible from off site, an adjoining lot, a public right-of-way, or the Crows Landing Airport.
4. Pole lights shall not exceed 30 feet in height.
5. Exterior building lighting shall be used to reinforce the architectural design, including lighting building entries, landscape elements, and major architectural features. Uplighting shall not be used because it could interfere with air navigation. However, other types of accent lighting that enhances interesting architectural or landscape features, but does not affect aviation may be used.

6. Exterior lighting on individual lots shall emphasize lighting entries, walkways, parking areas, and service areas.
7. A common light fixture style shall be used for all streets and shall be designed and spaced to provide adequate illumination for public safety.



*Examples of street lighting, including solar powered fixtures*

8. Pedestrian-scaled light fixtures, ranging from 12 feet to 16 feet, are recommended within the Plan Area to illuminate all sidewalks and connecting walkways. A common light fixture type and style shall be selected for use throughout the Plan Area.



*Examples of pedestrian scaled lighting, including solar powered fixtures*

9. Service area lighting shall be contained within service areas.
10. Lighting fixtures shall not conflict with on-site aviation activities.
  - a. All lights within the Plan Area must be equipped with shields to direct light downward so as to prevent conflicts with air navigation.
  - b. Lighting should be designed to prevent nesting and perching by wildlife or equipped with anti-perching devices.

### B.6.6 Gateway Entryway Features

Gateway features serve as entryways into the Plan Area and reflect the overall character of CLIBP.

#### *Standards*

1. Gateway features shall be located at the main entrances into the CLIBP at Fink Road, W. Marshall Road, and Bell Road (at Ike Crow Road) to help establish and give character and identity to the CLIBP.
2. Gateway features shall create an entry statement that is proportional in scale to the street and setting. Gateway features should be designed to incorporate formal plantings, signage or markers, and/or architectural features and public art.
3. Gateway elements should reinforce the overall landscape design theme, which may reflect the site's former military use and industrial uses through incorporating industrial materials in gateway features or public art.
4. Entryway features for individual development is also encouraged. These features should consist of special plantings, paving, and small entry sign, structure, monument, or art.
5. Art and sculptural elements are also encouraged to animate and give identity to gateways, special focal points, or central public spaces and contribute to the unique character and identity of the CLIBP.
6. Gateway features should be equipped with anti-perching devices as necessary.

### B.6.7 Site Edges and Agricultural Buffers

The required front, side, and rear yards identified in Table B-1 for areas adjacent to off-site agricultural uses have been incorporated to comply with Appendix A, Buffer and the Setback Guidelines presented in the County's adopted General Plan Agricultural Element at the time of CLIBP Specific Plan adoption. In accordance with the Guidelines, the following standards shall be applicable to development within the Plan Area:

#### *Standards*

1. **Buffer Setback Requirement.** Front, side, and rear yards located at a distance of less than the required 150-feet may be permitted with approval of a use permit, provided the decision making body: a) determines the lot will support a low-density/intensity use and will not serve the general public, or b) approves alternative buffer and setback design standards as allowed by the County's Buffer and Setback Guidelines (see Appendix VII-A of the Stanislaus County General Plan's Agriculture Element).
2. Permitted uses within the buffer area include public roadways, utilities, drainage facilities, landscaping, parking lots, and other similar low intensity uses.
3. A minimum 6-foot high fence of uniform construction shall be installed along the perimeter of any lot adjoining an agriculturally zoned property located outside of the Plan Area in order to prevent trespassing onto adjoining agricultural lands.
4. Any use requiring approval of a discretionary action to establish or expand shall be subject to individual compliance with any Buffer and Setback Guidelines applicable at the time of the action.

## **B.7 BUILDING AND ARCHITECTURAL STANDARDS**

The following standards are intended to help guide the development of buildings within the CLIBP Plan Area to create a comfortable, pedestrian-friendly work environment.

### **B.7.1 Building Siting and Orientation**

#### ***Standards***

1. Building entries, public areas, administration areas, and other more public spaces shall be oriented toward the street frontage.
2. New development shall be coordinated with and consider its relationship to adjacent buildings.
  - a. To create visual interest along streets and distinct identities for individual buildings when two or more buildings are to be located adjacent to each other, each should have a different setback from the street.
  - b. To optimize solar access and wintertime passive heating, buildings should be located in relationship to each other so that no building is shaded by another between the hours of 9:00 am and 3:00 pm on the shortest day of the year (December 21).

### **B.7.2 Building Scale and Massing**

1. Building sizes shall be designed to be flexible, to accommodate growth and change. Buildings shall be constructed with bay sizes that can accommodate a wide range of tenant needs.
2. Building massing and height should relate to existing site terrain and surrounding development.
3. Changes in building massing, such as second story areas and/or vaulted areas and atriums enrich the building design and can enhance the articulation of the building façade.
4. Terraced building designs with second story areas stepped back from the street are encouraged to create a scale transition from low (near the street edge) to high (away from the street).

### **B.7.3 Building Facades**

#### ***Standards***

1. Large flat, unarticulated building elevations shall not be permitted adjacent to a public street or view.
2. Building facades shall be articulated with a combination of windows, entries, and bays.
3. Large “box-like” structures should be avoided through the following design techniques:
  - Varying the planes of the exterior walls in depth and/or direction. Wall planes should not run in a continuous direction for more than 40 feet without an off-set of at least 2 feet.
  - Varying the height of buildings so they appear to be divided into distinct massing elements.
  - Articulating the different parts of a building’s façade through use of color, emphasis on horizontal or vertical planes and architectural elements, or a change in materials.

- Avoiding blank walls at the ground level floor and utilizing windows, trellises, wall articulation, arcades, material changes, landscaping, or other features to articulate and lessen the impact of an otherwise bulky building.
- Incorporating recesses and projections, entry elements, and layering of wall planes to create visual interest.
- The rear and side elevations should incorporate some of the architectural features of the main façade.
- Facades should not provide roosting, nesting, or shelter opportunities for birds or other wildlife.



*Articulate the building corners to reduce the appearance of bulky structures*

#### **B.7.4 Architectural Details – Colors, Materials, and Finishes**

##### ***General Standards***

1. Architectural details shall have a consistent style that creates a unified design across the building. For example, window details shall be consistent with door and canopy designs.
2. Use of industrial design and accent features is encouraged to animate building facades and entries. These features include window canopies, cornice projections, tension cables to support entry canopies or trellises, structural pilasters or columns, window mullions, and mechanical screens.

##### ***Color Standards***

1. Base building colors used within the Plan Area shall be earth-toned or muted colors that are compatible with the rural areas surrounding the industrial business park.

Brighter colors may be used as accents for trims, doors, window frames, shade canopies, and other accent elements as long as they complement the primary color of the overall structure, in order to give expression to individual properties and tenants.

##### ***Material and Finish Standards***

1. High quality building materials shall be used for all buildings, including, but not limited to architectural concrete, natural stone, and masonry (e.g., brick, terracotta, tile, and glass block).

2. Concrete construction, when used, should be designed to provide visual interest through surface texture treatments, trims, or other exterior materials.
3. Glazing shall be tinted with colors limited to green, blue, clear, or other lightly tinted shades.
4. High quality industrial design may successfully include certain metals, such as steel, aluminum, or other high quality metals. The use of prefabricated metal, such as rolled form metal or corrugated metal that would not contribute to a quality building design shall be avoided. Use of these metals shall be approved by the Planning Director, or his/her designee, as part of the site plan review.

## **B.8 PARKING STANDARDS**

### *Standards*

1. Off-street parking requirements for the CLIBP Plan Area are summarized below. For uses not listed, refer to the provisions of Chapter 21.76, “Off-Street Parking” in the County Zoning Code.

<b>Uses</b>	<b>Minimum Parking Spaces Required</b>
General business and professional	One space for every 300 square feet of gross floor area
Manufacturing or assembly plants	One space for every 600 square feet of gross floor area, or, if the number of employees on the maximum work shift is known, one space for each employee on the maximum work shift plus three additional spaces provided there is adequate area onsite to allow for no less than 50% of the non-employee based parking.
Warehouse/Storage/Distribution	One space for every 1,000 square feet of gross floor area.
Accessory employee services, such as cafe, fitness center, and similar employee service uses.	One space for every 300 square feet of gross floor area; however, a reduced parking standard may be permitted if it can be demonstrated, to the satisfaction of the Planning Director, or his/her designee, that existing parking spaces, on-site or off-site, can accommodate required parking spaces.

2. Wherever possible, the majority of off-street parking associated with any use should be located beside or behind its building(s).
3. Visitor and accessible parking should be located near a building’s primary entrance and is allowed in front of a building.
4. Entrances and exits to and from parking and loading facilities should be clearly marked with appropriate directional signage, where multiple access points are provided.
5. Shared parking lots and shared driveways from streets are allowed and encouraged to be provided wherever possible. Adjoining parking lots shall have driveways between them to accommodate vehicular



circulation and shared parking arrangements, unless determined infeasible or inappropriate by the Public Works Director or his/her designee.

6. All vehicle parking areas shall be accompanied by bicycle parking facilities; provided at a minimum of one bicycle parking space per 15,000 square feet of gross floor area.
7. Circulation routes and parking areas shall be separated. Pedestrian crosswalks between parking areas shall be clearly demarcated by sign and change in paving material/pattern.
8. For projects to be developed on lots adjoining the airport, parking areas shall be sited on the portion of the lot nearest to the airport property, and structures shall be sited on the portion of the lot farthest from the airport property.

### B.9 SIGNAGE STANDARDS

The primary goal of the CLIBP Plan Area sign system is to provide wayfinding or directional information and business identification. Signs must conform to the following sign requirements:

1. A sign program shall be provided, and approved, as part of any site plan review and shall reflect the ultimate buildout of the lot by single or multiple tenants. A sign plan shall identify:
  - a. **Detached Business Identification Signs:** One such monument sign shall be allowed for each street frontage of the lot. These signs may only contain the symbol and/or name of the business and its street address. The sign shall be freestanding, may be double-sided, and shall be set back a minimum of five feet from the ultimate public right-of-way; however, placement shall in no way impede vision clearance or create a safety hazard. Sign area shall not exceed 32 square feet per frontage and the sign shall not exceed six feet in height from finished grade. Signs should generally be oriented perpendicular to approaching traffic.
  - b. **Wall Signs:**
    - i. On single tenant buildings, signs should be located immediately above or adjacent to the primary building entrance. No sign shall extend above dominant roof lines. The area of any single sign shall not exceed 100 square feet. Total area shall not exceed one-half (0.5) square foot of sign per lineal foot of business being served.
    - ii. On multi-tenant buildings, signs should be located at the frontage of each individual tenant space. The area of any single sign shall not exceed 100 square feet and/or 75 percent of the tenant frontage. Letters shall be no more than two feet in height.
    - iii. When individually-lettered wall signs comprise over 50 percent of the sign area of all sign types, total sign area shall not exceed 1.2 square feet per lineal foot of business being served. When comprising less than 50 percent of the total sign area, the maximum sign area shall be one-half (0.5) square foot per lineal foot of business being served.
  - c. **Directional Signs:** Signs required or desired to assist patrons in accessing the facility shall be located in parking lot areas. The design of such signs shall be simple and easily legible. There is no limit to the number of signs provided; however, no single sign shall exceed 6 square feet in area, except that vehicular “stop” signs which shall be mounted, as required by state standards.

2. A sign may be illuminated from the front, or it may consist of letters, numbers or graphics that are backlit, provided that no flashing, traveling, animated, or intermittent illumination is used. Light projected from the front shall be confined to the area of the sign. No sign illumination shall cast a glare which is visible from any street or adjacent lot.
3. Signs shall be constructed using durable materials, such as stone, tile, cast concrete, or similar masonry materials, metal, and/or wood.
4. No freestanding pole or cabinet wall signs shall be permitted within the Plan Area.
5. Exposed conduits and tubing is prohibited. All transformers and other equipment shall be concealed.
6. Any signs allowed within a front or side yard of corner lots shall be reviewed by the Public Works Director, or his/her designee, to verify that clear sight distance is not blocked at driveways and/or intersections.
7. All signs should be constructed in a manner that is compatible with safe aviation.
  - a. Lighted signs shall include downward facing lights and shields to prevent conflicts with air navigation as a result of light or glare.
  - b. Signs shall not be constructed at heights that protrude into navigable surfaces or other areas.
  - c. All on-site signs shall be equipped with anti-perching/wildlife exclusion devices.

#### **B.10 PROPERTY MAINTENANCE STANDARDS**

1. Property shall be maintained at all times by leaseholder, including, but not limited to the following:
  - a. Irrigation, seeding, and pruning shall be performed, as necessary to maintain or replace planted areas.
  - b. All trash receptacles and dumpsters shall remain covered at all times and emptied regularly to avoid overflow, as well as other discarded materials and equipment.
  - c. Vehicles unrelated to the on-site business or in a deteriorated or incomplete condition shall not be stored on site.
  - d. Building facades, walls, and awnings and canopies shall be preserved through painting or other necessary maintenance.

Draft  
Aquatic Resource Delineation Report



Prepared for:



Stanislaus County

**AECOM**

November 2016

Draft

# Aquatic Resource Delineation Report



Prepared for:



Stanislaus County  
1010 10th Street, Suite 3400  
Modesto, CA 95354

Contact:

Keith Boggs  
Assistant Chief Executive Officer  
209/652-1514

Prepared by:

AECOM  
2020 L Street, Suite 400  
Sacramento, CA 95811

Contact:

Tammie Beyerl  
Senior Botanist  
916/414-5800

**AECOM**

November 2016

# TABLE OF CONTENTS

Section	Page
Introduction .....	1
Project Description.....	4
Delineation Methods.....	5
Soil Survey Results.....	7
Delineation Results .....	10
Jurisdictional Habitat Types .....	10
Waters of the United States .....	13
Wetlands Adjacent to Relatively Permanent Waters.....	14
Nonjurisdictional Habitats .....	14
Jurisdictional Determination.....	17
References .....	18

## Exhibits

1	Regional Location of the Project Site .....	2
2	Project Site and Vicinity.....	3
3	Habitat Map.....	11

## Tables

1	Anticipated Development by Land Use Category .....	4
2	Soil map units that occur in the study area according to the Soil Survey of Stanislaus County, California, Western Part .....	8
3	Potentially Jurisdictional Features.....	10
4	Potentially Nonjurisdictional Habitats .....	15

## Appendices

A	Wetland Delineation Data Forms
B	Soils Maps
C	Wetland Delineation Maps
D	Representative Photographs
E	Species Observed
F	Aquatic Resource Excel Sheet

## ACRONYMS AND ABBREVIATIONS

CWA	Clean Water Act
EPA	Environmental Protection Agency
FAC	Facultative
FACU	Facultative Upland
FACW	Facultative Wetland
GPS	Global Positioning System
msl	mean sea level
NRCS	Natural Resources Conservation Service
NI	No Indicator
NL	Not Listed
OBL	Obligate
OHWM	Ordinary High Water Mark
RPW	Relatively Permanent Water
SCS	Soil Conservation Service
TNW	Traditional Navigable Water
UPL	Upland
USACE	U.S. Army Corps of Engineers
USGS	U.S. Geological Survey

# INTRODUCTION

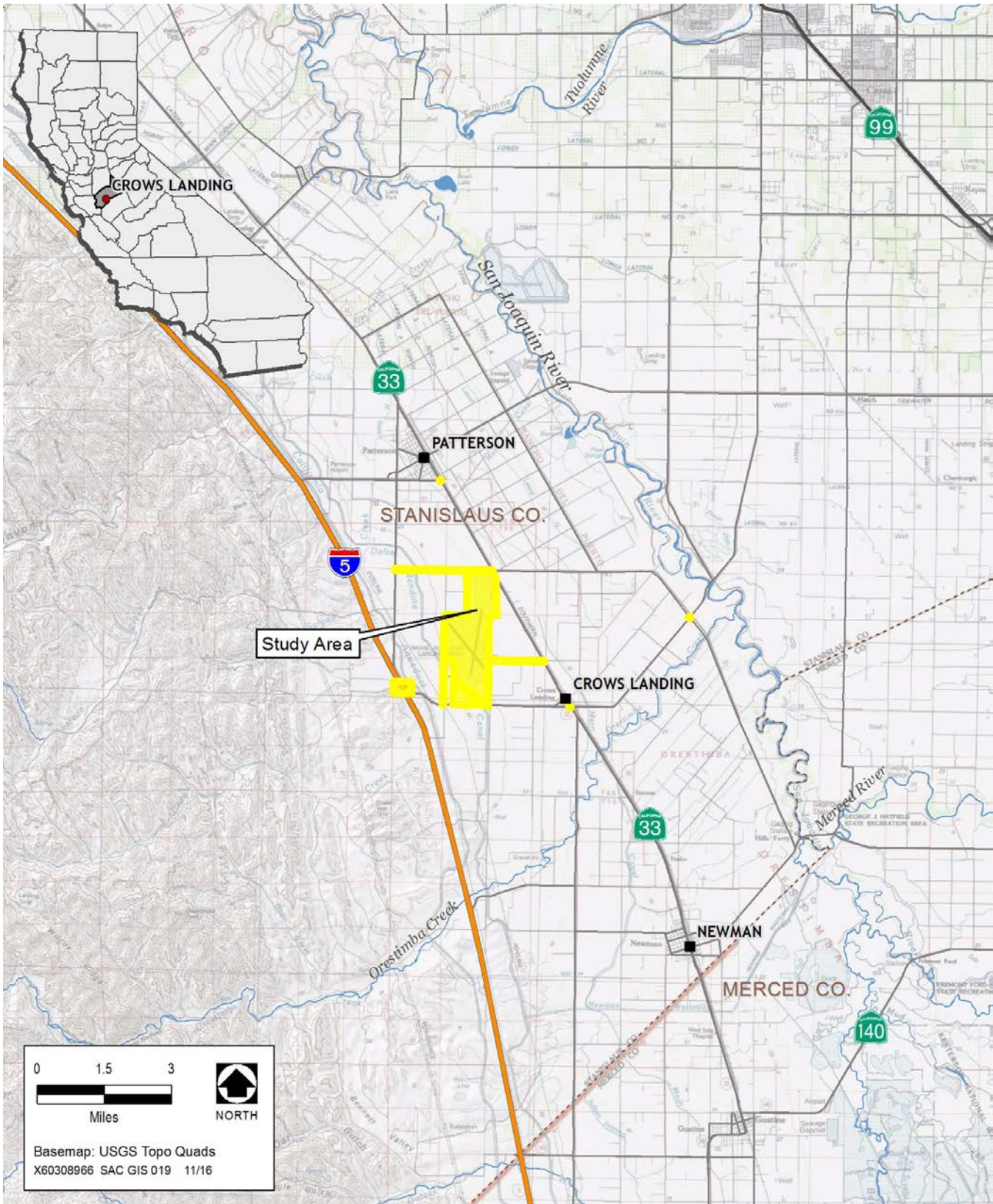
The proposed Crow's Landing Industrial Business Park (CLIBP) (project) is located in Stanislaus County, California. The approximately 1,647-acre study area for this delineation consists of the 1,528-acre CLIBP project site and 119 acres of off-site infrastructure improvement areas. The project site is situated approximately 3 miles southeast of the City of Patterson, 17 miles southwest of the City of Modesto, and 1 mile east of Interstate 5 (Exhibit 1). Off-site improvement areas for road and intersection upgrades are located adjacent to and surrounding the project site (Exhibit 1). Access to the study area is available from Bell Road via the Fink Road exit off of Interstate 5.

The study area is located in Sections 8, 9, 17, and 20 within the U.S. Geological Survey (USGS) 7.5-minute Crow's Landing quadrangle, Township 6 South, Range 8 East (Exhibit 2). Site topography is relatively flat with an elevation range of roughly 110 to 200 feet above mean sea level (msl) and slopes generally to the northeast toward State Route 33. The majority of the project site is used for agriculture, consisting of corn, tomato, and legume field crops. Additional crops found in the off-site roadway improvement areas include almond, walnut, and pistachio orchards. A Naval Auxiliary Landing Field that was transferred from the Navy to NASA in 1994 and was decommissioned in 1997 is located in the center of the project site. Beginning in 1999, NASA began the process of transferring ownership of the property to Stanislaus County. Prior to completing the land transfer to Stanislaus County, NASA initiated a series of clean-up operations to remediate soil and groundwater contamination that resulted from operation of the site as a Navy Auxiliary Landing Facility and then as a NASA flight facility.

The site includes two decommissioned military runways and associated aprons and taxiways, internal roadways, a control tower, lighting towers, and remnants of the former airfield lighting and navigational aids (a segmented circle). All structures associated with the defunct Naval facilities have been razed leaving concrete and asphalt pads, paved roads, landscaping, and disturbed ground. Only the former air traffic control tower and former airfield lighting vaults remain. A site that formerly housed Navy ammunition bunkers and refuse disposal pits is located north of the runway intersection. Two excavated sewer treatment basins that were part of the Navy's sewer system are located in the northeast portion of the site, but they are no longer used and overgrown with ruderal vegetation.

A channelized creek, Little Salado Creek, traverses the study area and multiple smaller ditches and basins are also present. Aside from agricultural fields, paved runways are the largest land cover on the project site and paved roadways are the largest land cover in the off-site improvement areas. The Delta-Mendota Canal bisects the project site in a northwest-southeast direction in a separate right-of-way that is excluded from the project site. The California Aqueduct flows in a north-south direction just west of the project boundary. The San Joaquin River, a traditional navigable water of the United States, is located approximately 4 miles east of the project site.

The purpose of this report is to provide an accurate quantification and delineation of waters of the United States, including wetlands, as defined by the U.S. Army Corps of Engineers (USACE) under Section 404 of the Clean Water Act (CWA) for the project. The delineation of waters of the United States is considered preliminary until verified by the Sacramento District of the USACE.

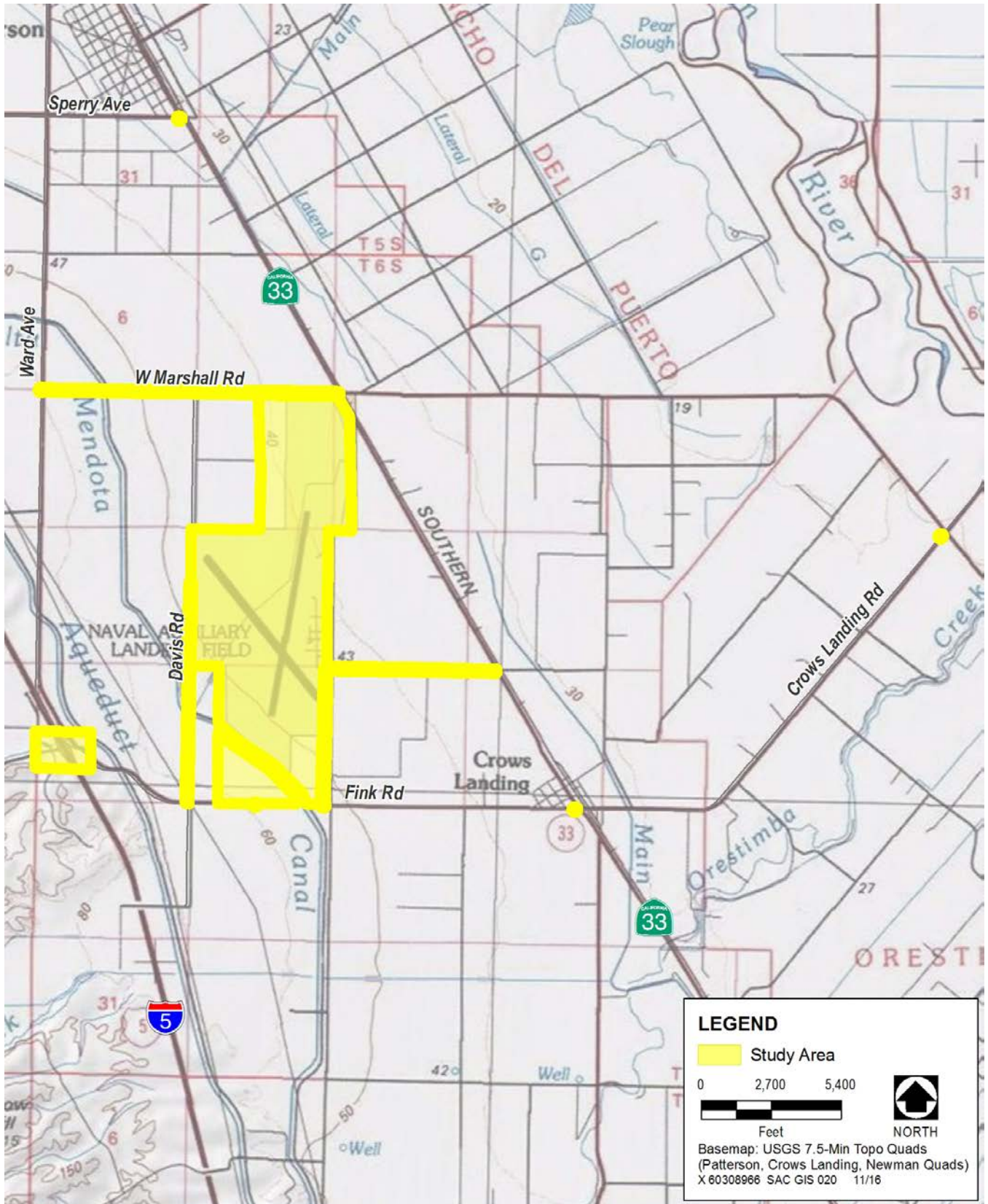


Source: Stanislaus County 2013

**Regional Location of the Project Site**

**Exhibit 1**





Source: Stanislaus County 2013

**Project Site and Vicinity**

**Exhibit 2**

# PROJECT DESCRIPTION

The proposed project would be developed over an approximately 30-year timeframe and include the following major components:

- ▶ Adoption of a specific plan and rezone to support the development of various aviation-compatible land uses on the former military site;
- ▶ Planning and construction of initial “backbone” infrastructure to ready the site for long-term leaseholds and development (e.g., water supply, wastewater, hydrology and drainage improvements, and dry utilities);
- ▶ Planning and construction of internal roadways and phased improvements to off-site roads and intersections in the project vicinity;
- ▶ Adoption of an Airport Layout Plan (ALP) and Narrative Report to support the development of a public-use, general aviation airport to support and complement the proposed CLIBP; and
- ▶ An amendment to the Stanislaus County Airport Land Use Compatibility Plan (ALUCP) to provide new policies specific to the new public-use airport.

The proposed specific plan identifies a suite of general land use types. As shown in Table 1, seven general land use categories were identified for development on the project site. These land uses would be developed in three 10-year phases to create approximately 14,000 to 15,000 jobs at full build out.

As shown in Table 1, approximately 83 percent of the site (or approximately 1,274 of the estimated 1,528 acres) has been identified for development. The remaining 254 acres would accommodate necessary infrastructure. Each broad land use category is described in the specific plan and summarized below. The specific plan also identifies several, more defined land uses that could be developed in the specific plan area in accordance with the broad categories presented in Table 1.

**Table 1  
Anticipated Development by Land Use Category (acres)**

Land Use	Description	Total Use (acres)
<b>Logistics/Distribution</b>	Packaging, warehouse, and distribution, etc.	349
<b>Light Industrial</b>	Light industrial manufacturing, machine shops, etc.	350
<b>Business Park</b>	Research and development, business support services, etc.	78
<b>Public Facilities</b>	Municipal and County offices, professional offices, emergency services, etc.	68
<b>General Aviation</b>	Airport runways, aprons, hangars, etc.	370
<b>Aviation Related</b>	Parcel distribution, aviation classroom training, etc.	46
<b>Green Space / Multimodal Transportation Corridor</b>	Bicycle and pedestrian path, greenway, monument to military use.	13
<b>All Uses by Phase</b>		1,274
<b>Infrastructure</b>	Internal roadways, water and wastewater systems, stormwater drainage, etc.	254
<b>Plan Area Total</b>		1,528

Off-site two-lane roadways would be rebuilt as a part of the project, including portions of Bell Road, Davis Road, Ike Crow Road and Marshall Road. Marshall Road would be expanded from two to four lanes adjacent to the

project site as a part of the project. Proposed improvements at the Fink Road-Interstate 5 interchange include widening beneath the Interstate 5 overpass to construct a left-turn lane to the southbound onramp. Signal lights would also be installed at the following off-site intersection locations:

- ▶ Sperry Avenue at State Route 33
- ▶ Marshall Road at Ward Avenue
- ▶ Marshall Road at State Route 33
- ▶ Marshall Road at project site entrance
- ▶ Ike Crow Road at State Route 33
- ▶ Fink Road at Bell Road
- ▶ Fink Road at project site entrance
- ▶ Crow's Landing Road at Marshall Road
- ▶ Fink Road at State Route 33
- ▶ Fink Road at Interstate 5 northbound ramps

## DELINEATION METHODS

Before conducting the field delineation survey of the study area, AECOM wetland ecologists reviewed color aerial imagery of the project site on Google Earth, National Wetlands Inventory (NWI) data, and the Natural Resources Conservation Service's (NRCS) soil survey of *Stanislaus County, California, Western Part* (NRCS Web Soil Survey 2013, 2016) to determine areas of potential USACE jurisdiction. Aquatic resources delineation was conducted at the project site on November 26 and December 26, 2013, by AECOM wetland ecologists Tammie Beyerl and Pam Valle. Delineation of the off-site improvement areas was conducted by AECOM wetland ecologist Charlie Battaglia on October 18, 2016. Daytime temperatures were in the low to high 60°F range and skies were sunny and clear during all of the delineation field surveys. Annual precipitation was below average in the area through December, 2013 (DWR 2013), but was 111 percent of average for the water year as of September 30, 2016 (DWR 2016).

The USACE 1987 wetlands delineation manual (Environmental Laboratory 1987) and *Regional Supplement to the Corps of Engineers Wetland Delineation Manual: Arid West Region* (Environmental Laboratory 2008) were used to delineate wetlands that are potentially subject to USACE jurisdiction under Section 404 of the CWA. The 1987 manual and 2008 Arid West Supplement provide technical guidelines and methods for the three-parameter approach to determining the location and boundaries of jurisdictional wetlands. This approach requires that an area support positive indicators of hydrophytic vegetation, hydric soils, and wetland hydrology to be considered a jurisdictional wetland. Routine wetland determination data forms were completed for 17 sample points and are provided in Appendix A. Potential jurisdictional areas were identified and mapped in the field and later digitized onto aerial imagery. Sample point locations were recorded digitally using a global positioning system (GPS) data logger (Trimble XH) and imported onto an electronic version of the aerial photograph. GPS data were recorded in North American Datum of 1983.

To determine whether the area at a sample point was dominated by hydrophytic vegetation, plant species at each sample site were recorded and the wetland indicator status was recorded for the dominant species using USACE's *National Wetlands Plant List for the Arid West Region* (Lichvar and Kartesz 2013). A species is considered dominant when that species—individually or collectively—accounts for 50 percent of the total absolute cover in a vegetation stratum. Additional codominant species are identified if those species account for at least 20 percent of the absolute cover in a designated vegetation stratum (Environmental Laboratory 2008).

Hydrophytic species include those listed as obligate (OBL), facultative wetland (FACW), or facultative (FAC) species, which correspond to a given species frequency of occurrence in wetlands. The plant indicator categories are defined as:

- ▶ OBL: greater than 99 percent occurrence in wetlands,
- ▶ FACW: between 66 percent and 99 percent occurrence in wetlands, and
- ▶ FAC: between 33 percent and 66 percent occurrence in wetlands.

For purposes of this delineation, a sample site was considered to have hydrophytic vegetation if greater than 50% of the dominant species had an indicator status of FAC or wetter. This report uses the following indicators to identify species not considered hydrophytic:

- ▶ *Facultative upland (FACU)*— species that usually occur in nonwetlands (67 percent–99 percent estimated probability) but are occasionally found in wetlands (1 percent–33 percent estimated probability),
- ▶ *Obligate upland (UPL)*— species that may occur in wetlands in another region, but almost always (greater than 99 percent) occur in nonwetlands in California (Region 0) under natural conditions,
- ▶ *No indicator (NI)*—species for which insufficient information was available to determine an indicator status, and
- ▶ *Not listed (NL)*—species not listed in *National Wetland Plant List* (Lichvar et. al. 2016).

Standard protocol states that a species with an NL designation should be considered UPL when the delineator completes the “Prevalence Index Worksheet” portion of the wetland delineation data form (Environmental Laboratory 2010). Botanical nomenclature follows *The Jepson Manual: Vascular Plants of California, Second Edition* (Baldwin et al. 2012).

Wetland hydrology was assessed by recording observations such as inundation, oxidized rhizospheres along living root channels, and saturation signatures on aerial imagery. In addition, the potentially jurisdictional areas were all evaluated in terms of their status as a navigable waterway or their adjacency or hydrological connection to a navigable waterway.

Waters of the United States were delineated based on the ordinary high water mark (OHWM) using the OHWM field guide (Lichvar and McColley 2008). A drainage feature’s OHWM typically corresponds with characteristics such as shelving, scour lines, and other natural linear features which define the bed and bank portion of the channel that floods under normal conditions (USACE 2005).

Soils were examined by digging soil test pits to determine whether hydric soils exist in a sampling location. Soils were described in terms of depth, matrix color, moisture status, and other diagnostic features indicative of hydric soils, such as the presence of concretions and oxidized rhizospheres (a redoximorphic feature, according to Vepraskas [1995]). Hydric soil indicators were based on those provided in the 1987 USACE manual, 2008 Arid West Supplement, *Field Indicators of Hydric Soils in the United States: A Guide for Identifying and Delineating Hydric Soils* (USDA and NRCS 2010), and Vepraskas (1995).

The *U.S. Army Corps of Engineers Jurisdictional Determination Form Instructional Guidebook* (USACE 2007) was consulted to aid the preliminary determination that an area would be subject to USACE jurisdiction under CWA Section 404. The significant nexus test—outlined in a memorandum jointly authored by the U.S. Environmental Protection Agency (EPA) and USACE—was applied to each potentially jurisdictional habitat type (Grumbles and Woodley 2008). To facilitate jurisdictional determination consistent with the guidance, each water body delineated was evaluated as a Traditional Navigable Water (TNW), Relatively Permanent Water (RPW), or non-RPW based on the following definitions:

- ▶ *TNWs*—all waters subject to the ebb and flow of the tide, or waters that are presently used, have been used in the past, or may be used in the future to transport interstate or foreign commerce, and all waters that are navigable in fact under federal law for any purpose
- ▶ *RPWs*—waters that flow continuously at least seasonally (typically at least 3 months of the year) and are not *TNWs*
- ▶ *Non-RPWs*—waters that do not have continuous flow at least seasonally
- ▶ The following types of water bodies are subject to CWA jurisdiction:
  - ▶ all *TNWs* and adjacent wetlands,
  - ▶ relatively permanent tributaries of *TNWs* and wetlands with a continuous surface connection to such tributaries, and
  - ▶ Non-relatively permanent tributaries of *TNWs* and adjacent wetlands if they have a significant nexus to a *TNW*. Non-*RPWs* and adjacent wetlands are determined to have a significant nexus to a *TNW* if they significantly affect the chemical, physical, or biological integrity of a downstream *TNW*.
- ▶ The “Clean Water Rule: Definition of Waters of the United States (Final Rule)” was also consulted to aid the preliminary determination that an area would be subject to USACE jurisdiction under CWA Section 404 (80 FR 37054, June 29, 2015). The conclusions of this report are consistent with the new Final Rule.

## **SOIL SURVEY RESULTS**

Table 2 provides a list of the soil map units that occur on the project site, according to the Soil Survey of *Stanislaus County, California, Western Part*, a brief description, and the hydric status of the soil map unit. The locations of these soil units within the study area, as mapped by NRCS, are depicted on the soils map in Appendix B.

**Table 2**  
**Soil map units that occur in the study area according to the Soil Survey of Stanislaus County, California, Western Part**

Name	Map Unit	Soil Series	Taxonomic Class	Description	Hydric?
Capay clay, 0 to 2 percent slopes	100	Capay	Fine, smectitic, thermic Typic Haploxererts	Very deep, moderately well-drained soils formed in alluvium derived mostly from sandstone and shale. Found on alluvial fans, alluvial flats, interfan basins, and basin rims. Used for growing irrigated crops such as tomatoes, sugar beets, beans, and grain sorghum; dryland grain crops; and irrigated or dryland pasture. Vegetation in uncultivated areas is typically characterized by dense cover of annual grasses and forbs. These soils have 1 to 2 centimeter wide cracks that open and close at least once each year and remain open for 150 days or less during summer. Some pedons have a water table between a depth of 4 to 6 feet and some areas are subject to rare, occasional, or frequent flooding.	No
Capay clay, wet, 0 to 2 percent slopes	101				
Capay clay, loamy substratum, 0 to 2 percent slopes	102				
Capay clay, 0 to 2 percent slopes, rarely flooded	106				
Vernalis-Zacharias complex, 0 to 2 percent slopes	120	Vernalis and Zacharias	See series below	See individual descriptions for Vernalis and Zacharias soil series below.	No
Vernalis loam, 0 to 2 percent slopes	122	Vernalis	Fine-loamy, mixed, superactive, thermic Calcic Haploxerepts	Very deep, well-drained soils on alluvial fans and floodplains. Formed in alluvium from mixed rock sources. Used mostly for irrigated crops, but some areas used for livestock grazing or dry farming small grains. Uncultivated areas are typically vegetated with annual grasses and forbs. These soils are usually dry between depths of 5 to 15 inches from late April through November or early December and moist in some or all parts the rest of the year.	No
Vernalis clay loam, 0 to 2 percent slopes	125				
Stomar clay loam, 0 to 2 percent slopes	130	Stomar	Fine, smectitic, thermic Mollic Haploxeralfs	Very deep, well-drained soils formed in alluvium from sedimentary rocks. Found on dissected alluvial fans and terraces. Used for irrigated cropland including field crops, row crops, and orchards. Also used for dryland crops such as grain and, to a lesser degree, for urban development or livestock grazing. Vegetation in uncultivated areas is typically characterized by annual grasses and forbs. These soils are dry in all parts between depths of 4 to 12 inches from mid-May to November and moist in all parts from mid-December to May.	No
Zacharias clay loam, 0 to 2 percent slopes	140	Zacharias	Fine-loamy, mixed, superactive, thermic Typic Haploxerepts	Very deep, well-drained soils formed in alluvium from mixed rock. Found on alluvial fans and low stream terraces. Used primarily for irrigated cropland, including field crops, row crops, and orchards; pasture and livestock grazing. Vegetation in uncultivated areas is typically characterized by annual grasses and forbs. These soils are moist between depths of 5 to 15 inches in some or all parts from November until May and dry in all parts the rest of the year.	No
Dumps	176			No description	No

**Table 2**  
**Soil map units that occur in the study area according to the Soil Survey of Stanislaus County, California, Western Part**

Name	Map Unit	Soil Series	Taxonomic Class	Description	Hydric?
Calla-Carbona complex, 30 to 50 percent slopes	255	Calla and Carbona	Calla: Fine-loamy, mixed, superactive, thermic Typic Calcixerepts Carbona: Fine, smectitic, thermic Vertic Haploxerolls	Very deep, well-drained clay and clay loam soils found on dissected and uplifted terraces; parent material is alluvium from calcareous sedimentary rock (Calla) and mixed rock (Carbona). The soil in all parts between 6 and 18 inches is dry from May through October and moist in all parts from late-December to mid-March. These soils are used for livestock grazing or for irrigated orchards. The natural vegetation is annual grasses and forbs such as soft chess, filaree, foxtail fescue, and wild oats.	No
Elsalado loam, 0 to 2 percent slopes	274	Elsalado	Coarse-loamy, mixed, superactive, thermic Fluventic Haploxerepts	Deep, well-drained loam soils found on alluvial fans; parent material is alluvium derived from sandstone-shale and the soils are slightly or moderately alkaline. The soil between 7 and 22 inches is dry in all parts from mid-May to November and is moist in all parts from mid-December to May. Used for irrigated cropland, including field crops, row, crops, and orchards. Natural vegetation is annual grasses and forbs.	No

Source: NRCS Official Soil Series Descriptions 2016, NRCS Web Soil Survey 2016

## DELINEATION RESULTS

Sites qualifying as waters of the United States according to Section 404 of the CWA are depicted on the aquatic resources delineation maps in Appendix C. Delineation sample sites are also depicted on the aquatic resources delineation map and are cross-referenced to the wetland determination data forms provided in Appendix A. Habitat descriptions for waters of the United States and nonjurisdictional habitats are included below; a habitat map is provided as Exhibit 3. Representative photographs of habitat types described below are provided in Appendix D and a list of plant species observed during the field survey is provided in Appendix E.

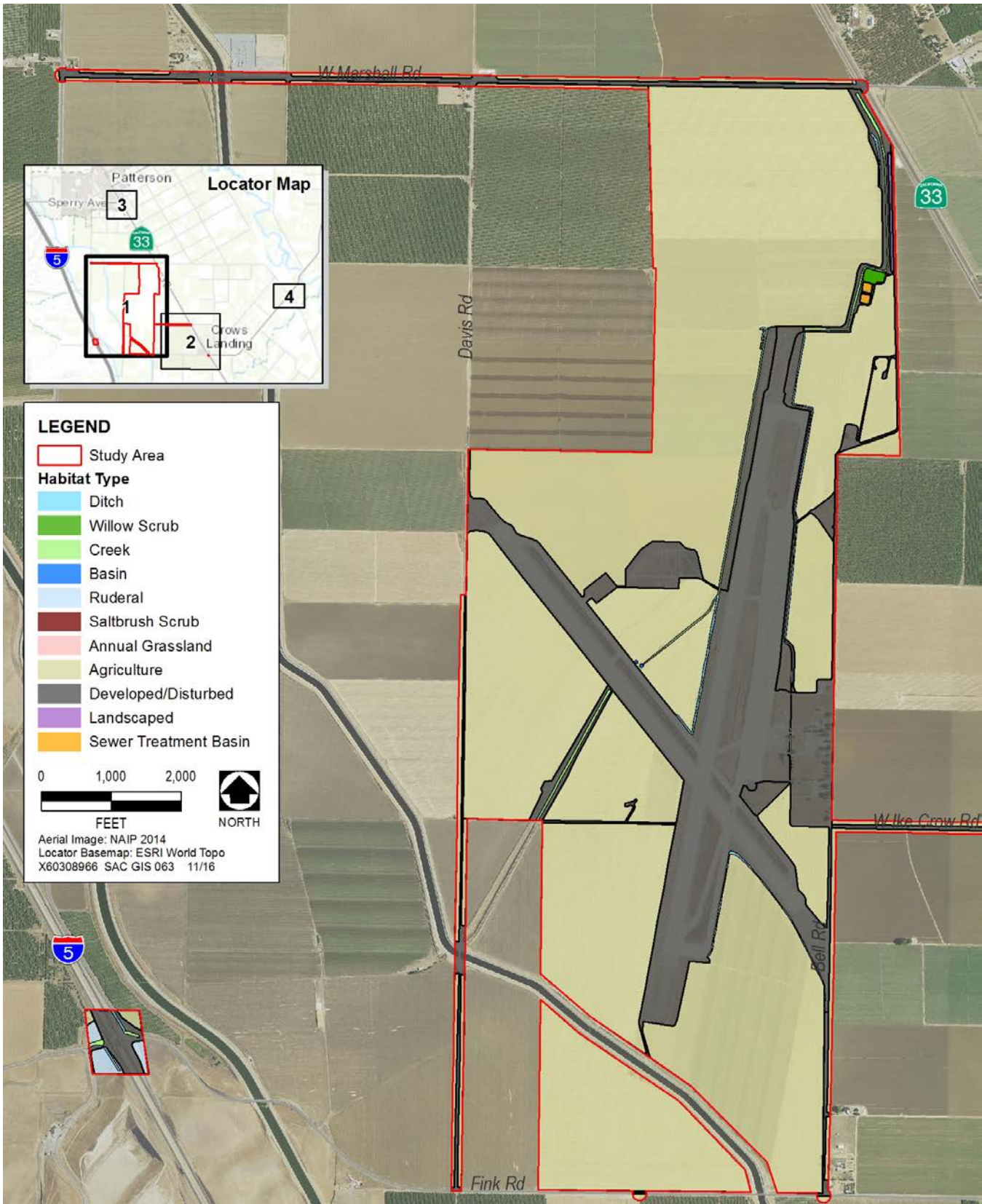
### JURISDICTIONAL HABITAT TYPES

A total of 4.66 acres of potentially jurisdictional waters of the United States, including wetlands, are present within the 1,647-acre study area (Table 3). The study area contains approximately 3.65 acres of RPW in Little Salado Creek and small excavated collection basins. Approximately 1.01 acre of willow scrub wetland is present on the project site adjacent to Little Salado Creek.

<b>Table 3</b>	
<b>Potentially Jurisdictional Features</b>	
Waters of the United States	Acres
<b>Relatively Permanent Waters (RPW)</b>	<b>3.65</b>
<i>Little Salado Creek (LSC)</i>	<b>3.60</b>
LSC1	1.29
LSC2	0.99
LSC3	0.98
LSC4	0.01
LSC5	0.13
LSC6	0.20
<b>Basins (BN)</b>	<b>0.05</b>
BN1	0.04
BN2	0.01
<b>Wetlands Adjacent to RPWs</b>	<b>1.01</b>
<i>Willow Scrub Wetland (WS1)</i>	<b>1.01</b>
<b>Total Jurisdictional Features</b>	<b>4.66</b>

Source: Data compiled by AECOM in 2014

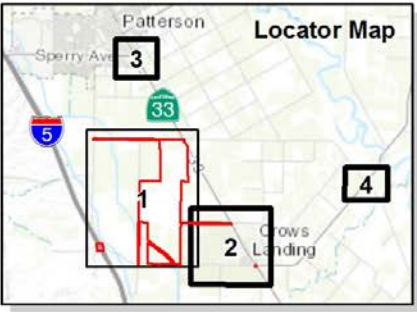
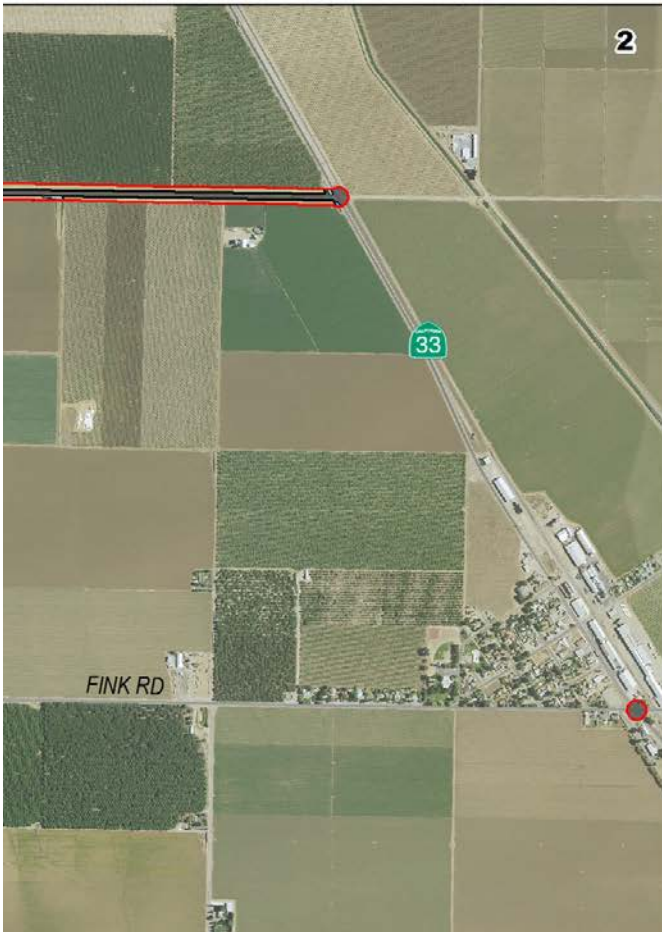
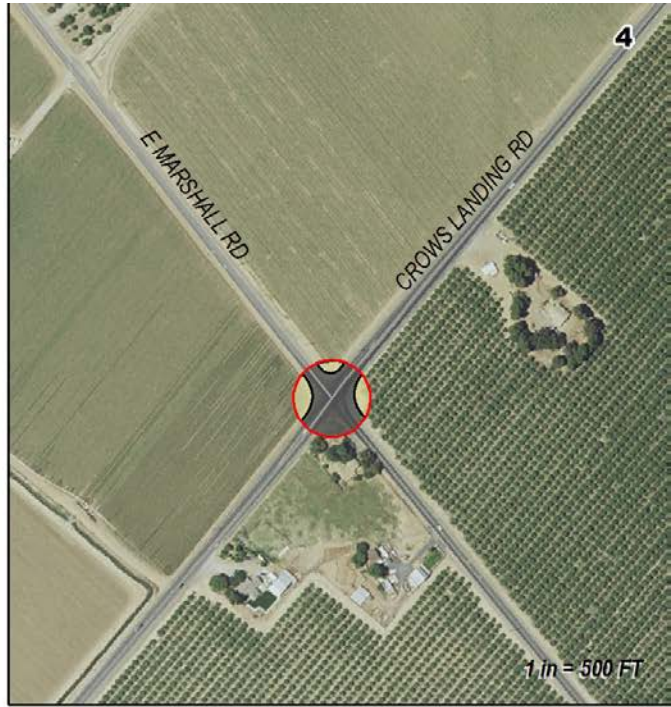
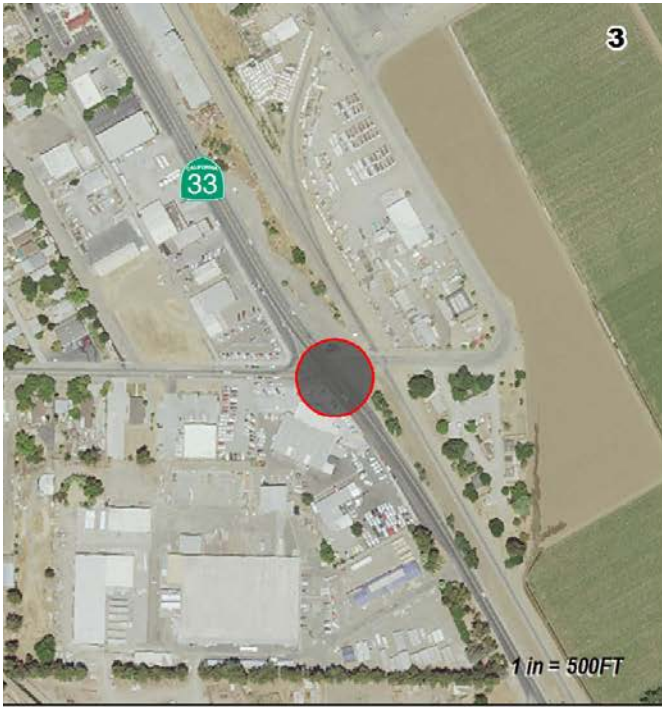




Source: Data compiled by AECOM in 2014

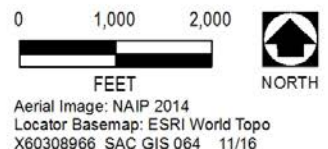
Habitat Map

Exhibit 3



**LEGEND**

Study Area	Saltbrush Scrub
<b>Habitat Type</b>	Annual Grassland
Ditch	Agriculture
Willow Scrub	Developed/Disturbed
Creek	Landscaped
Basin	Sewer Treatment Basin
Ruderal	



Source: Data compiled by AECOM in 2014

**Habitat Map**

**Exhibit 3**

# WATERS OF THE UNITED STATES

## RELATIVELY PERMANENT WATERS

RPWs are tributaries to TNWs that typically have continuous flow for at least 3 months of the year. These features meet the criteria of waters of the United States and are subject to USACE jurisdiction under Section 404 of the CWA. RPWs within the project site consist of a channelized creek known as Little Salado Creek and two small excavated basins. These features were delineated based on their OHWM.

### SEASONAL STREAM

Little Salado Creek is single-thread, channelized, seasonal stream that flows through the project site in a northeasterly direction. There are a total of approximately 3.60 acres of Little Salado Creek within the study area (3.26 acres on the project site and 0.34 acre in the off-site improvement areas). The average width of the OHWM through the project site is approximately 20 feet, but it ranges from 4 feet to 40 feet in width. The creek bed is characterized by clay loam soil with high shrink swell potential creating large, deep cracks as the channel dries. The channel contains patches of emergent vegetation characterized by weedy wetland species including barnyard grass (*Echinochloa crus-galli*) (FACW), dotted smartweed (*Persicaria punctata*) (OBL), broad-leaved cattail (*Typha latifolia*) (OBL), and tall flatsedge (*Cyperus eragrostis*) (FACW).

Little Salado Creek runs from the eastern foothills of the Diablo Range west of the project site, crosses under the Delta Mendota Canal through a box culvert, and then flows in a modified channel through agricultural fields and onto the project site. On the east side of the Delta-Mendota Canal, Little Salado Creek serves as a tailwater irrigation drain ditch for the surrounding agricultural fields. The channel was straightened, deepened, and confined within earthen levees through the project site beginning in 1943 when the air facility was constructed. Little Salado Creek ends in the northeast corner of the project site where the water is discharged through a culvert under Highway 33 into a single 24-inch diameter drain pipe that flows east along Marshall Road for about 4.5 miles to its final discharge point at the San Joaquin River.

Little Salado Creek crosses through the off-site improvement area at the Interstate 5-Fink Road interchange in a highly modified and fragmented channel that runs along the north side of Fink Road and crosses under the Interstate 5 overpass through a culvert. This is the apparent realigned flow channel of historic Little Salado Creek. Flow in this portion of the creek is ephemeral and vegetation in the channel and on the banks is composed of weedy, primarily upland species including riggut brome (*Bromus diandrus*) (NL), black mustard (*Brassica nigra*) (NL), and Russian thistle (*Salsola tragus*) (FACU).

Little Salado Creek was delineated as an RPW feature subject to USACE jurisdiction under Section 404 of the CWA because it has an OHWM, supports continuous uninterrupted flow for a portion of the year, and is hydrologically connected to a TNW (i.e., the San Joaquin River). Data forms 1, 2, 6, and 16 in Appendix A contain information about the habitat in the channel of Little Salado Creek in the study area.

### BASINS

Two small excavated basins comprising a total of 0.05 acre are present toward the center of the project site where Little Salado Creek meets the edge of a runway. One of the basins is directly connected to Little Salado Creek via culvert while the other is connected by pump. Based on review of aerial imagery, these basins were created in 2011 and are typically inundated for long duration during the growing season. BN1 was created by widening and deepening the channel of Little Salado Creek and building an earthen berm across the downstream end of the excavated area. BN2 was excavated in uplands and water from Little Salado Creek is pumped into BN2. The basins have the same bed substrate as the channel of Little Salado Creek and support the same vegetation assemblages at the high water line. The bottoms of the basins were bare of vegetation during the field delineation and had large deep soil cracks.

These basins were delineated as RPWs subject USACE jurisdiction under Section 404 of the CWA because they each have an OHWM, are continuously inundated for a portion of the year, and were excavated in or are connected to Little Salado Creek.

## **WETLANDS ADJACENT TO RELATIVELY PERMANENT WATERS**

Wetlands adjacent to RPWs are not automatically subject to USACE jurisdiction under Section 404 of the CWA (Grumbles and Woodley 2008). The post-Rapanos guidance significant nexus test requires that wetlands adjacent to RPWs contribute substantially to the physical, chemical, and biological character of the downstream traditionally navigable water (TNW). The significant nexus evaluation includes consideration of hydrologic and ecological factors in addition to the aforementioned physical, chemical, and biological parameters associated with the wetland adjacent to a RPW.

### **WILLOW SCRUB WETLAND**

Approximately 1.01 acre of willow scrub wetland habitat occurs within a created basin adjacent to Little Salado Creek. The basin was created in a cooperative effort by the Boy Scouts of America, the Navy, NRCS, and the Resource Conservation District to provide wildlife habitat. Vegetation in the basin is characterized by dense cover of narrow-leaf willow (*Salix exigua*) (FACW) and Goodding's black willow (*Salix gooddingii*) (FACW). The ground surface below the willows has heavy cover of leaf litter and woody debris and did not support herbaceous vegetation at the time of the delineation. Characteristics such as shelving, scour lines, or other natural linear features indicating an OHWM are not present in this created basin and surface water was not observed in the basin in any aerial imagery going back to 1998. A culvert with a control gate connects the basin to Little Salado Creek through the creek's levee, but water from the creek has not been diverted to the basin for many years.

Oxidized root channels, a primary indicator of wetland hydrology were observed in the willow scrub wetland habitat. Based on the absence of an OHWM, it is assumed that the water table is high in this location and the wetland vegetation is supported by groundwater. Redox dark surface, a hydric soil indicator, was observed in the willow scrub wetland. The willow scrub wetland would be classified under the Cowardin Classification System as a palustrine scrub-shrub, persistent, saturated wetland (Cowardin 1979). This area is not mapped in the National Wetlands Inventory.

This area is considered a jurisdictional habitat by the USACE under Section 404 of the CWA because it is adjacent to Little Salado Creek, a RPW, and meets the three parameter definition of a wetland. Data form 4 provides information about the willow scrub wetland habitat on the project site.

## **NONJURISDICTIONAL HABITATS**

A total of approximately 1,641 acres of nonjurisdictional upland habitats consisting of agriculture, saltbush scrub, sewer treatment basin, landscaped, developed/disturbed areas, and ditches are present on the project site (Table 4). These habitats, except the ditches, are determined to be nonjurisdictional because they are not dominated by hydrophytic vegetation, do not have indicators of wetland hydrology or hydric soils, and/or are located outside an OHWM. The ditches are determined to be nonjurisdictional waters because they have only ephemeral or intermittent flow, are not relocated tributaries or excavated in tributaries, and do not drain wetlands. This delineation is considered preliminary until verified by the USACE.

<b>Table 4</b>	
<b>Potentially Nonjurisdictional Habitats</b>	
Upland Habitat Types	Acres
Agriculture	1,207.03
Saltbush Scrub	0.17
Sewer Treatment Basin	0.89
Landscaped	1.73
Developed/Disturbed	423.83
Ruderal	5.16
<b>Ditches (D)</b>	<b>2.56</b>
D1	0.18
D2	0.01
D3	0.01
D4A	0.41
D4B	0.23
D4C	0.03
D4D	0.04
D4E	0.02
D4F	0.02
D4G	0.05
D5	0.65
D6	0.34
D7	0.03
D8	0.03
D9	0.03
D10	0.04
D11	0.11
D12	0.03
D13	0.03
D14	0.13
D15	0.14
<b>Total Nonjurisdictional Features</b>	<b>1,641.37</b>

6367Source: Data compiled by AECOM in 2014

## AGRICULTURE

The predominant land cover type on the project site is agriculture consisting of sugar beets, peas, beans, tomatoes, grain sorghum, spinach, melons, and corn crops. Outside of the runways and former Naval facilities sites, the remaining lands, approximately 1,146 acres, have been leased to private tenants and actively farmed since the Crows Landing Naval auxiliary Landing Field was commissioned in 1943. The majority of the site was actively farmed prior to 1943. The agricultural lands are harvested seasonally then tilled and replanted. Crops on the project site are irrigated with water taken from Little Salado Creek and pumped through spray irrigation systems and temporary irrigation channels. As evidenced by small areas of the project site, such as the former firing range, that have been taken out of agricultural production, these areas would likely become dominated by ruderal upland vegetation, as described below, if active cultivation and irrigation ceased because they are not supported by natural wetland hydrology. The agricultural lands are considered non-jurisdictional under Section 404 of the CWA because they do not meet the three criteria for wetlands and are not located within the OHWM of a jurisdictional feature.

## SALTBUSH SCRUB

Approximately 0.17 acre of saltbush scrub is present on the project site. This habitat was created as part of a cooperative effort by the Boy Scouts of America, the Navy, NRCS, and the Resource Conservation District to provide wildlife habitat. The saltbush scrub habitat is located on the bank of an excavated basin containing willow

scrub habitat, which was also created through the cooperative effort. The saltbush scrub community has a shrub layer dominated exclusively by big saltbush (*Atriplex lentiformis*) (FAC). The herb layer is characterized by low cover of blessed milk thistle (*Silybum marianum*) (NL) and annual yellow sweetclover (*Melilotus indicus*) (FACU). This area is not dominated hydrophytes and lacks hydric soil indicators and evidence of recent wetland hydrology; therefore, it is not subject to USACE jurisdiction under Section 404 of the CWA. Data form 5 in Appendix A provides information about the saltbush scrub habitat on the project site.

## **SEWER TREATMENT BASINS**

Two sewer treatment basins that were excavated in uplands are present on the project site adjacent to Little Salado Creek. The total area of the basins is approximately 0.89 acre. These treatment basins are associated with the former Naval facilities sewer system and are not currently in use. Sewage was previously collected in a concrete trunk line and sent to a processing tank then to these basins for settling and drying. In 2003, the Navy conducted clean-up operations to remove refuse, debris, contaminated soil, and incinerator ash from the basins.

Vegetation in the basins is dominated by upland herbaceous plants including black mustard and annual willowherb (*Epilobium brachycarpum*) (NL). Other common associates include yellow star thistle, blessed milk thistle, curly dock (*Rumex crispus*) (FAC), and common sunflower (*Helianthus annuus*) (FACU). Characteristics such as shelving, destruction of vegetation, presence of litter or debris, or other natural linear features indicating an OHWM are not present in the basins and surface water was observed infrequently in aerial imagery going back to 1998. The basins were completely dry at the time this delineation field survey was conducted. These basins do not exhibit wetland hydrology indicators and are not dominated by wetland vegetation; soil pits were not excavated in this habitat type because the vegetation and hydrology parameters are lacking and they are created sewer treatment basins. It was therefore determined that these features do not meet the three criteria to be considered a jurisdictional wetland feature under Section 404 of the CWA. Data form 3 in appendix A provides information about the sewer treatment basins.

## **LANDSCAPED**

A 1.73-acre strip of roadside landscaping is present along the eastern boundary of the project site between Bell Road and the east side levee of Little Salado Creek. Vegetation in this strip of land is characterized by dense cover of firethorn (*Pyracantha angustifolia*) (NL) and Russian olive (*Elaeagnus angustifolia*) (FAC) with no herbaceous understory. The Russian olive and firethorn were planted in parallel rows and may have been planted as part of the wildlife habitat creation initiated by the Boy Scouts the Navy, NRCS, and the Resource Conservation District. The landscaped vegetation is located in a low-lying landscape position between the toe slope of the levee and the road bed of Bell Road. This area is not dominated hydrophytes and lacks hydric soil indicators and evidence of recent wetland hydrology; therefore, it is not subject to USACE jurisdiction under Section 404 of the CWA. Data form 8 in Appendix A provides information about this landscaped area.

## **DEVELOPED/DISTURBED**

The project site contains approximately 372 acres of developed and disturbed lands. Defunct Naval support facilities, including a control tower, administrative office sites, fire and rescue facilities, former hangar sites and underground fuel storage tanks, and an old school site were located on the east side of the project site between Bell Road and the runways. All structures associated with the Naval facilities have been razed leaving concrete and asphalt pads, paved roads, landscaping, and disturbed ground. Only the former air traffic control tower and former airfield lighting vaults remain. A site that formerly housed Navy ammunition bunkers and refuse disposal pits is located north of the runway intersection and another ammunition area is located on the banks of Little Salado Creek just north of Ike Crow Road. Other developed and disturbed areas on the project site include the runways, a former small arms firing range, and sites that housed soil and groundwater treatment facilities.

Areas categorized as developed/disturbed include areas covered by impervious surfaces, such as the runways and access roads and building foundations, and areas that were subjected to past intensive disturbances, including

complete removal of the native vegetation, soil disturbance, and topographic alteration. These lands either have not fully recovered from past disturbances or are still subjected to ongoing soil and vegetation disturbances and are currently characterized by bare soil or ruderal vegetation cover.

Vegetation around the former Naval support facilities consists of remnant lawn grass dominated by tall fescue (*Festuca arundinacea*) (NL), Kentucky bluegrass (*Poa pratensis*) (FAC), and Bermuda grass (*Cynodon dactylon*) (FACU); landscaped trees and shrubs, including golden wattle (*Acacia longifolia*) (NL), firethorn, European privet (*Ligustrum vulgare*) (UPL), and deodar cedar (*Cedrus deodara*) (NL); and ruderal herbaceous species. Ruderal vegetation found in developed/disturbed areas is dominated by weedy plants adapted to establish on disturbed bare ground. Characteristic species in the ruderal vegetation communities on site include common oat (*Avena sativa*) (UPL), ripgut brome (*Bromus diandrus*) (NL), rattail sixweeks fescue (*Festuca myuros*) (FACU), bur clover (*Medicago polymorpha*) (FACU), Italian thistle (*Carduus pycnocephalus*) (NL), and yellow star thistle.

The developed/disturbed and ruderal areas are considered non-jurisdictional under Section 404 of the CWA because they do not meet the three criteria for wetlands and are not located within the OHWM of a jurisdictional feature. Data forms 7 and 9 in Appendix A provide information on developed/disturbed areas. Sample point 7 is at a former firing range, and sample point 8 is on the levee bank of Little Salado Creek.

## DITCHES

A total of 2.56 acres of ditches are present in the study area. There are nine ditches, or ditch fragments, totaling approximately 2.02 acres on the project site, and an additional 6 ditches totaling 0.54 acre in the off-site improvement areas. The ditches consist of agricultural ditches used to deliver irrigation water to crops and recapture irrigation tailwater, and ditches constructed along roadways and runways to convey stormwater runoff. These features flow periodically for short duration during storm events and crop irrigation. Vegetation in the ditches on the project site and off-site roadside ditches is characterized primarily by upland plant species including Johnsongrass (*Sorghum halepense*) (FACU), black mustard, bristly ox-tongue (*Helminthotheca echioides*) (FACU), yellow star thistle (*Centaurea solstitialis*) (NL), ripgut brome, and Russian thistle. Characteristic vegetation in the off-site irrigation ditches consists of a mix of wetland and upland species including barnyard grass, tall flatsedge, pigweed amaranth (*Amaranthus albus*) (FACU), and field bindweed (*Convolvulus arvensis*) (NL). One agricultural ditch extending from the south side of Marshall Road southward along the west side of the Delta-Mendota Canal had water in it at the time of the field delineation. All of the remaining ditches were completely dry at the time the delineation field surveys were conducted. The width of the OHWM of the ditches ranges from 2 feet to 14 feet and averages approximately 5 feet on the project site. The ditches in the off-site improvement areas are mostly larger, ranging from 3 to 26 feet in width and averaging 22 feet at the OHWM. The ditches were delineated as nonjurisdictional waters because they have only ephemeral or intermittent flow, are not relocated tributaries or excavated in tributaries, and do not drain wetlands. Data forms 10, 11, 12, 13, 14, 15, and 17 in Appendix A provide information about representative ditches in the study area.

## JURISDICTIONAL DETERMINATION

As summarized in Table 2, the 1,647-acre study area contains a total of approximately 4.66 acres of potentially jurisdictional waters of the United States, including wetlands. These potentially jurisdictional waters of the United States consist of 3.60 acres of Little Salado Creek and 0.05 acre of excavated basins. Little Salado Creek and the excavated basins are RPWs. Wetlands in the study area consist of 1.01 acre of willow scrub wetland adjacent to Little Salado Creek. Little Salado Creek is connected to the San Joaquin River, a TNW, through a series of canals that are part of a storm drain system, and is therefore subject to USACE jurisdiction under Section 404 of the CWA. The excavated collection basins (BN1 and BN2) are contiguous with or connected to Little Salado Creek. The willow scrub wetland is adjacent to Little Salado Creek and is connected to the creek by a gated culvert through an earthen levee separating the creek from the basin containing the willow scrub wetland. Non-RPWs and

wetlands adjacent to non-navigable RPWs must have a significant influence on the downstream physical, chemical, and biological integrity of waters of the United States before they may be regulated under Section 404 of the CWA. The willow scrub wetland could have a significant effect on downstream waters due to its hydrological connectivity to Little Salado Creek. Therefore, these features are potentially subject to USACE regulation pursuant to Section 404 of the CWA.

Agriculture, saltbush scrub, sewer treatment basins, landscaped, and developed/disturbed lands lack one or more criteria that define wetlands, do not possess an OHWM, and are located above an OHWM. The roadside and agricultural ditches have only ephemeral or intermittent flow, are not relocated tributaries or excavated in tributaries, and do not drain wetlands. These habitats are generally not subject to regulation by the USACE under Section 404 of the CWA. This jurisdictional determination is preliminary and contingent on verification by USACE.

## REFERENCES

- California Department of Water Resources. 2013. California Data Exchange Center. Query of daily accumulated precipitation from 08/08/2012 to 09/30/2016. Available: [http://cdec.water.ca.gov/cgi-progs/queryMM?staid=SLH&sensor\\_num=&d=11%2F21%2F1&span=30](http://cdec.water.ca.gov/cgi-progs/queryMM?staid=SLH&sensor_num=&d=11%2F21%2F1&span=30). Accessed 1/6/2014 and 11/18/2016.
- Cowardin, L.M., V. Carter, F.C. Golet, and E.T. LaRoe. 1979. *Classification of Wetlands and Deepwater Habitats of the United States*. U.S. Fish and Wildlife Service. Washington DC.
- Environmental Laboratory. 1987. *U.S. Army Corps of Engineers Wetlands Delineation Manual*. (Technical Report Y-87-1.) U.S. Army Corps of Engineers Waterways Experiment Station. Vicksburg, MS.
- . 2008. *Regional Supplement to the Corps of Engineers Wetland Delineation Manual: Arid West Region* (Version 2.0). (Technical Report ERDC/EL TR-08-28.) U.S. Army Corps of Engineers, Engineers Research and Development Center. Vicksburg, MS.
- Grumbles, B. H., and J. P. Woodley, Jr. 2008 (December 2). *Clean Water Act Jurisdiction Following the U.S. Supreme Court's Decision in Rapanos v. United States and Carabell v. United States*. Memorandum to U.S. Environmental Protection Agency regions and U.S. Army Corps of Engineers districts. Washington, DC.
- Lichvar, RW. And S.M. McColley. 2008 A Field Guide to Identification of the Ordinary High Water Mark (OHWM) in the Arid West Region of the United States. (Technical Report ERDC/CRREL TR-08-12). Cold Regions Research and Engineering Laboratory. U.S. Army Corps of Engineers, Engineers Research and Development Center. Hanover, NH
- Lichvar, R. W., and J. T. Kartesz. 2013. *North American Digital Flora: National Wetlands Plant List*. Version 3.1. U.S. Army Corps of Engineers. Available: [http://wetland\\_plants.usace.army.mil/](http://wetland_plants.usace.army.mil/). Accessed November-December, 2013.
- Lichvar, R.W., D.L. Banks, W.N. Kirchner, and N.C. Melvin. 2016. The National Wetland Plant List: 2016 wetland ratings. *Phytoneuron* 2016-30: 1-17. Available: [http://wetland\\_plants.usace.army.mil/](http://wetland_plants.usace.army.mil/). Accessed November 18, 2016.
- Natural Resources Conservation Service. 2006. *Field Indicators of Hydric Soils in the United States: A Guide for Identifying and Delineating Hydric Soils*, Version 6.0.



- . 2010. Field Indicators of Hydric Soils in the United States: A Guide for Identifying and Delineating Hydric Soils Version 7.0. Available: [http://www.nrcs.usda.gov/Internet/FSE\\_DOCUMENTS/nrcs142p2\\_050723.pdf](http://www.nrcs.usda.gov/Internet/FSE_DOCUMENTS/nrcs142p2_050723.pdf).
- . 2012. National Hydric Soils List by State (California). Updated April, 2012. Available: <http://soils.usda.gov/use/hydric/>. Accessed November 25, 2013.
- . 2016. Web Soil Survey. Available: <http://websoilsurvey.nrcs.usda.gov/>. Accessed: November 25, 2013 and October 21, 2016.
- . 2016. Official Soil Series Descriptions. Available: <https://soilseries.sc.egov/asdname.asp>. Accessed December 30, 2013 and October 21, 2016.
- National Aeronautics and Space Administration. 2003. Draft Environmental Assessment for the Transfer of NASA Crows Landing Flight Facility. NASA Environmental Services Office, NASA Ames Research Center. Moffett Field, CA.
- NASA. *See* National Aeronautics and Space Administration.
- NRCS. *See* Natural Resources Conservation Service.
- USACE. *See* U.S. Army Corps of Engineers.
- U.S. Army Corps of Engineers. 2007. *U.S. Army Corps of Engineers Jurisdictional Determination Form Instructional Guidebook*. Washington, DC.
- . 2005 (December 7). *Ordinary High Water Mark Identification*. Regulatory Guidance Letter No. 05-05.
- Vepraskas, M. J. 1994. *Redoximorphic Features for Identifying Aquic Conditions*. (Technical bulletin 301.) North Carolina Agricultural Research Service, North Carolina State University. Raleigh, NC.



# **APPENDIX A**

---

## Wetland Delineation Data Forms



**WETLAND DETERMINATION DATA FORM – Arid West Region**

Project/Site: Crow's Landing City/County: Stanislaus State: CA Sampling Date: 11/26/13  
 Applicant/Owner: Stanislaus County Sampling Point: 1  
 Investigator(s): T. Beyert, Y. Valle Section, Township, Range: \_\_\_\_\_  
 Landform (hillslope, terrace, etc.): terrace Local relief (concave, convex, none): none Slope (%): 0  
 Subregion (LRR): LRRC Lat: 37° 25' 32.49" N Long: 121° 06' 23.37" W Datum: \_\_\_\_\_  
 Soil Map Unit Name: Capay clay, 0 to 2% slopes, rarely flooded NW classification: \_\_\_\_\_  
 Are climatic / hydrologic conditions on the site typical for this time of year? Yes X No \_\_\_\_\_ (If no, explain in Remarks.) Precip 10% normal  
 Are Vegetation N, Soil N, or Hydrology N significantly disturbed? Are "Normal Circumstances" present? Yes X No \_\_\_\_\_  
 Are Vegetation N, Soil N, or Hydrology N naturally problematic? (If needed, explain any answers in Remarks.)

**SUMMARY OF FINDINGS – Attach site map showing sampling point locations, transects, important features, etc.**

Hydrophytic Vegetation Present?	Yes <input checked="" type="checkbox"/>	No _____	Is the Sampled Area within a Wetland? <u>Photo 4791, 92, 4802</u> Yes <input checked="" type="checkbox"/> No _____
Hydric Soil Present?	Yes <input checked="" type="checkbox"/>	No _____	
Wetland Hydrology Present?	Yes <input checked="" type="checkbox"/>	No _____	
Remarks: <u>Modified / channelized Little Salado Creek, OTHWM is 20 feet wetland vegetation is within the OTHWM of the canal.</u>			

**VEGETATION – Use scientific names of plants.**

Tree Stratum (Plot size: _____)	Absolute % Cover	Dominant Species?	Indicator Status	Dominance Test worksheet:
1. _____				Number of Dominant Species That Are OBL, FACW, or FAC: <u>1</u> (A)  Total Number of Dominant Species Across All Strata: <u>1</u> (B)  Percent of Dominant Species That Are OBL, FACW, or FAC: <u>100</u> (A/B)
2. _____				
3. _____				
4. _____				
_____ = Total Cover				<b>Prevalence Index worksheet:</b> Total % Cover of: _____ Multiply by: _____ OBL species _____ x 1 = _____ FACW species _____ x 2 = _____ FAC species _____ x 3 = _____ FACU species _____ x 4 = _____ UPL species _____ x 5 = _____ Column Totals: _____ (A) _____ (B)  Prevalence Index = B/A = _____
<b>Sapling/Shrub Stratum (Plot size: _____)</b>				
1. <u>Salix gooddingii</u>	<u>2</u>	<u>N</u>	<u>FACW</u>	
2. _____				
3. _____				
4. _____				
<u>2</u> = Total Cover				
<b>Herb Stratum (Plot size: _____)</b>				
1. <u>Echinochloa crus-galli</u>	<u>45</u>	<u>Y</u>	<u>FACW</u>	
2. <u>Cyperus erasrostis</u>	<u>5</u>	<u>N</u>	<u>FACW</u>	
3. <u>Epilobium brachycarpum</u>	<u>5</u>	<u>N</u>	<u>NL</u>	
4. <u>Helmintotheca echioides</u>	<u>10</u>	<u>N</u>	<u>NL</u>	
5. <u>Rumex crispus</u>	<u>5</u>	<u>N</u>	<u>FAC</u>	
6. _____				
7. _____				
8. _____				
<u>70</u> = Total Cover				
<b>Woody Vine Stratum (Plot size: _____)</b>				
1. _____				
2. _____				
_____ = Total Cover				
% Bare Ground in Herb Stratum <u>30</u>		% Cover of Biotic Crust _____		
Hydrophytic Vegetation Present? Yes <input checked="" type="checkbox"/> No _____				
Remarks: _____				

**SOIL**

Sampling Point: 1

**Profile Description: (Describe to the depth needed to document the indicator or confirm the absence of indicators.)**

Depth (inches)	Matrix		Redox Features				Texture	Remarks
	Color (moist)	%	Color (moist)	%	Type <sup>1</sup>	Loc <sup>2</sup>		
							Clay	

<sup>1</sup>Type: C=Concentration, D=Depletion, RM=Reduced Matrix, CS=Covered or Coated Sand Grains.      <sup>2</sup>Location: PL=Pore Lining, M=Matrix.

Hydric Soil Indicators: (Applicable to all LRRs, unless otherwise noted.)		Indicators for Problematic Hydric Soils <sup>3</sup> :	
<input type="checkbox"/> Histosol (A1)	<input type="checkbox"/> Sandy Redox (S5)	<input type="checkbox"/> 1 cm Muck (A9) (LRR C)	
<input type="checkbox"/> Histic Epipedon (A2)	<input type="checkbox"/> Stripped Matrix (S6)	<input type="checkbox"/> 2 cm Muck (A10) (LRR B)	
<input type="checkbox"/> Black Histic (A3)	<input type="checkbox"/> Loamy Mucky Mineral (F1)	<input type="checkbox"/> Reduced Vertic (F18)	
<input type="checkbox"/> Hydrogen Sulfide (A4)	<input type="checkbox"/> Loamy Gleyed Matrix (F2)	<input type="checkbox"/> Red Parent Material (TF2)	
<input type="checkbox"/> Stratified Layers (A5) (LRR C)	<input type="checkbox"/> Depleted Matrix (F3)	<input type="checkbox"/> Other (Explain in Remarks)	
<input type="checkbox"/> 1 cm Muck (A9) (LRR D)	<input type="checkbox"/> Redox Dark Surface (F6)		
<input type="checkbox"/> Depleted Below Dark Surface (A11)	<input type="checkbox"/> Depleted Dark Surface (F7)		
<input type="checkbox"/> Thick Dark Surface (A12)	<input type="checkbox"/> Redox Depressions (F8)		
<input type="checkbox"/> Sandy Mucky Mineral (S1)	<input type="checkbox"/> Vernal Pools (F9)		
<input type="checkbox"/> Sandy Gleyed Matrix (S4)			

<sup>3</sup>Indicators of hydrophytic vegetation and wetland hydrology must be present, unless disturbed or problematic.

**Restrictive Layer (if present):**  
 Type: \_\_\_\_\_  
 Depth (inches): \_\_\_\_\_

Hydric Soil Present? Yes  No

Remarks: *No soil pit - sample point is within OTHW of an intermittent canal (channelized Little Colorado creek)*

**HYDROLOGY**

**Wetland Hydrology Indicators:**

Primary Indicators (minimum of one required; check all that apply)		Secondary Indicators (2 or more required)	
<input type="checkbox"/> Surface Water (A1)	<input type="checkbox"/> Salt Crust (B11)	<input type="checkbox"/> Water Marks (B1) (Riverine)	
<input type="checkbox"/> High Water Table (A2)	<input type="checkbox"/> Biotic Crust (B12)	<input type="checkbox"/> Sediment Deposits (B2) (Riverine)	
<input type="checkbox"/> Saturation (A3)	<input type="checkbox"/> Aquatic Invertebrates (B13)	<input type="checkbox"/> Drift Deposits (B3) (Riverine)	
<input type="checkbox"/> Water Marks (B1) (Nonriverine)	<input type="checkbox"/> Hydrogen Sulfide Odor (C1)	<input type="checkbox"/> Drainage Patterns (B10)	
<input type="checkbox"/> Sediment Deposits (B2) (Nonriverine)	<input type="checkbox"/> Oxidized Rhizospheres along Living Roots (C3)	<input type="checkbox"/> Dry-Season Water Table (C2)	
<input type="checkbox"/> Drift Deposits (B3) (Nonriverine)	<input type="checkbox"/> Presence of Reduced Iron (C4)	<input type="checkbox"/> Crayfish Burrows (C8)	
<input checked="" type="checkbox"/> Surface Soil Cracks (B6)	<input type="checkbox"/> Recent Iron Reduction in Tilled Soils (C6)	<input type="checkbox"/> Saturation Visible on Aerial Imagery (C9)	
<input checked="" type="checkbox"/> Inundation Visible on Aerial Imagery (B7)	<input type="checkbox"/> Thin Muck Surface (C7)	<input type="checkbox"/> Shallow Aquitard (D3)	
<input type="checkbox"/> Water-Stained Leaves (B9)	<input type="checkbox"/> Other (Explain in Remarks)	<input type="checkbox"/> FAC-Neutral Test (D5)	

**Field Observations:**

Surface Water Present? Yes  No  Depth (inches): \_\_\_\_\_

Water Table Present? Yes  No  Depth (inches): \_\_\_\_\_

Saturation Present? (includes capillary fringe) Yes  No  Depth (inches): 2

Wetland Hydrology Present? Yes  No

Describe Recorded Data (stream gauge, monitoring well, aerial photos, previous inspections), if available:

Remarks:

**WETLAND DETERMINATION DATA FORM – Arid West Region**

Project/Site: Crow's Landing City/County: Stanislaus Sampling Date: 11/26/13  
 Applicant/Owner: Stanislaus County State: CA Sampling Point: 2  
 Investigator(s): T. Beyerl, P. Valle Section, Township, Range: \_\_\_\_\_  
 Landform (hillslope, terrace, etc.): terrace Local relief (concave, convex, none): none Slope (%): \_\_\_\_\_  
 Subregion (LRR): LRRC Lat: 37°25'32.48" N Long: 121°06'08.98" W Datum: \_\_\_\_\_  
 Soil Map Unit Name: Capay clay, 0 to 2% slopes, rarely flooded NWI classification: \_\_\_\_\_  
 Are climatic / hydrologic conditions on the site typical for this time of year? Yes  No \_\_\_\_\_ (If no, explain in Remarks.)  
 Are Vegetation N, Soil N, or Hydrology N significantly disturbed? Are "Normal Circumstances" present? Yes  No \_\_\_\_\_  
 Are Vegetation N, Soil N, or Hydrology N naturally problematic? (If needed, explain any answers in Remarks.)

**SUMMARY OF FINDINGS – Attach site map showing sampling point locations, transects, important features, etc.**

Hydrophytic Vegetation Present?	Yes <input checked="" type="checkbox"/>	No _____	Photos: 4803-4805 Is the Sampled Area within a Wetland? Yes <input checked="" type="checkbox"/> No _____
Hydric Soil Present?	Yes <input checked="" type="checkbox"/>	No _____	
Wetland Hydrology Present?	Yes <input checked="" type="checkbox"/>	No _____	
Remarks: <u>canal / channelized intermittent creek vegetated within OTWm Little Salado creek</u>			

**VEGETATION – Use scientific names of plants.**

Tree Stratum (Plot size: _____)	Absolute % Cover	Dominant Species?	Indicator Status	Dominance Test worksheet:	
1. _____				Number of Dominant Species That Are OBL, FACW, or FAC: <u>2</u>	(A)
2. _____				Total Number of Dominant Species Across All Strata: <u>2</u>	(B)
3. _____				Percent of Dominant Species That Are OBL, FACW, or FAC: <u>100</u>	(A/B)
4. _____				Prevalence Index worksheet:	
				Total % Cover of: _____	Multiply by: _____
				OBL species _____	x 1 = _____
				FACW species _____	x 2 = _____
				FAC species _____	x 3 = _____
				FACU species _____	x 4 = _____
				UPL species _____	x 5 = _____
				Column Totals: _____	(A) _____ (B) _____
				Prevalence Index = B/A = _____	
				Hydrophytic Vegetation Indicators:	
				___ Dominance Test is >50%	
				___ Prevalence Index is ≤3.0 <sup>1</sup>	
				___ Morphological Adaptations <sup>1</sup> (Provide supporting data in Remarks or on a separate sheet)	
				___ Problematic Hydrophytic Vegetation <sup>1</sup> (Explain)	
				<sup>1</sup> Indicators of hydric soil and wetland hydrology must be present, unless disturbed or problematic.	
				Hydrophytic Vegetation Present? Yes <input checked="" type="checkbox"/> No _____	
				Remarks: <u>Above OTWm vegetation consists of Salsola tragus, Brassica nigra, Helianthus annuus, Epilobium brachycarpum - narrow strip of upland vegetation then the rest of the bank is maintained in a barren state (levee road)</u>	

**SOIL**

Sampling Point: 2

**Profile Description: (Describe to the depth needed to document the indicator or confirm the absence of indicators.)**

Depth (inches)	Matrix		Redox Features				Texture	Remarks
	Color (moist)	%	Color (moist)	%	Type <sup>1</sup>	Loc <sup>2</sup>		
0-8	7.5YR 2.5/2	90	5YR 5/8	10	C	PL	C	blocky, fragmented
8-20	10YR 3/2	75	10YR 5/6	25	C	M	CL	

<sup>1</sup>Type: C=Concentration, D=Depletion, RM=Reduced Matrix, CS=Covered or Coated Sand Grains.      <sup>2</sup>Location: PL=Pore Lining, M=Matrix.

**Hydric Soil Indicators: (Applicable to all LRRs, unless otherwise noted.)**

<input type="checkbox"/> Histosol (A1)	<input type="checkbox"/> Sandy Redox (S5)	<input type="checkbox"/> 1 cm Muck (A9) (LRR C)
<input type="checkbox"/> Histic Epipedon (A2)	<input type="checkbox"/> Stripped Matrix (S6)	<input type="checkbox"/> 2 cm Muck (A10) (LRR B)
<input type="checkbox"/> Black Histic (A3)	<input type="checkbox"/> Loamy Mucky Mineral (F1)	<input type="checkbox"/> Reduced Vertic (F18)
<input type="checkbox"/> Hydrogen Sulfide (A4)	<input type="checkbox"/> Loamy Gleyed Matrix (F2)	<input type="checkbox"/> Red Parent Material (TF2)
<input type="checkbox"/> Stratified Layers (A5) (LRR C)	<input checked="" type="checkbox"/> Depleted Matrix (F3)	<input type="checkbox"/> Other (Explain in Remarks)
<input type="checkbox"/> 1 cm Muck (A9) (LRR D)	<input checked="" type="checkbox"/> Redox Dark Surface (F6)	
<input type="checkbox"/> Depleted Below Dark Surface (A11)	<input type="checkbox"/> Depleted Dark Surface (F7)	
<input type="checkbox"/> Thick Dark Surface (A12)	<input type="checkbox"/> Redox Depressions (F8)	
<input type="checkbox"/> Sandy Mucky Mineral (S1)	<input type="checkbox"/> Vernal Pools (F9)	
<input type="checkbox"/> Sandy Gleyed Matrix (S4)		

<sup>3</sup>Indicators of hydrophytic vegetation and wetland hydrology must be present, unless disturbed or problematic.

**Restrictive Layer (if present):**

Type: \_\_\_\_\_  
 Depth (inches): \_\_\_\_\_

Hydric Soil Present? Yes  No

Remarks: Point is within OHWM of Little Salado Creek

**HYDROLOGY**

**Wetland Hydrology Indicators:**

<u>Primary Indicators (minimum of one required; check all that apply)</u>		<u>Secondary Indicators (2 or more required)</u>
<input type="checkbox"/> Surface Water (A1)	<input type="checkbox"/> Salt Crust (B11)	<input type="checkbox"/> Water Marks (B1) (Riverine)
<input type="checkbox"/> High Water Table (A2)	<input type="checkbox"/> Blotic Crust (B12)	<input type="checkbox"/> Sediment Deposits (B2) (Riverine)
<input type="checkbox"/> Saturation (A3)	<input type="checkbox"/> Aquatic Invertebrates (B13)	<input type="checkbox"/> Drift Deposits (B3) (Riverine)
<input type="checkbox"/> Water Marks (B1) (Nonriverine)	<input type="checkbox"/> Hydrogen Sulfide Odor (C1)	<input type="checkbox"/> Drainage Patterns (B10)
<input type="checkbox"/> Sediment Deposits (B2) (Nonriverine)	<input type="checkbox"/> Oxidized Rhizospheres along Living Roots (C3)	<input type="checkbox"/> Dry-Season Water Table (C2)
<input type="checkbox"/> Drift Deposits (B3) (Nonriverine)	<input type="checkbox"/> Presence of Reduced Iron (C4)	<input type="checkbox"/> Crayfish Burrows (C8)
<input checked="" type="checkbox"/> Surface Soil Cracks (B6)	<input type="checkbox"/> Recent Iron Reduction in Tilled Soils (C6)	<input type="checkbox"/> Saturation Visible on Aerial Imagery (C9)
<input checked="" type="checkbox"/> Inundation Visible on Aerial Imagery (B7)	<input type="checkbox"/> Thin Muck Surface (C7)	<input type="checkbox"/> Shallow Aquitard (D3)
<input type="checkbox"/> Water-Stained Leaves (B9)	<input type="checkbox"/> Other (Explain in Remarks)	<input type="checkbox"/> FAC-Neutral Test (D5)

**Field Observations:**

Surface Water Present? Yes  No  Depth (inches): \_\_\_\_\_

Water Table Present? Yes  No  Depth (inches): \_\_\_\_\_

Saturation Present? (includes capillary fringe) Yes  No  Depth (inches): \_\_\_\_\_

Wetland Hydrology Present? Yes  No

Describe Recorded Data (stream gauge, monitoring well, aerial photos, previous inspections), if available:

Remarks: OHWM ≈ 30ft  
Very deep soil cracks



**WETLAND DETERMINATION DATA FORM – Arid West Region**

Project/Site: Crow's Landing City/County: Stanislaus State: CA Sampling Date: 11/26/13  
 Applicant/Owner: Stanislaus County Sampling Point: 3  
 Investigator(s): T. Beyerl, P. Valle Section, Township, Range: \_\_\_\_\_  
 Landform (hillslope, terrace, etc.): terrace Local relief (concave, convex, none): none Slope (%): 0  
 Subregion (LRR): LRRC Lat: 37°25'36.91"N Long: 121°06'05.82"W Datum: \_\_\_\_\_  
 Soil Map Unit Name: Capay clay, 0 to 2% slopes, rarely flooded NWI classification: \_\_\_\_\_  
 Are climatic / hydrologic conditions on the site typical for this time of year? Yes  No \_\_\_\_\_ (If no, explain in Remarks.)  
 Are Vegetation N, Soil N, or Hydrology N significantly disturbed? Are "Normal Circumstances" present? Yes  No \_\_\_\_\_  
 Are Vegetation N, Soil N, or Hydrology N naturally problematic? (If needed, explain any answers in Remarks.)

**SUMMARY OF FINDINGS – Attach site map showing sampling point locations, transects, important features, etc.**

Hydrophytic Vegetation Present? Yes _____ No <input checked="" type="checkbox"/> Hydric Soil Present? Yes _____ No <input checked="" type="checkbox"/> Wetland Hydrology Present? Yes _____ No <input checked="" type="checkbox"/>	Is the Sampled Area within a Wetland? Yes _____ No <input checked="" type="checkbox"/>
Remarks: <u>excavated sewage treatment basin</u> <u>Photos 4808-4812</u>	

**VEGETATION – Use scientific names of plants.**

Tree Stratum (Plot size: _____)	Absolute % Cover	Dominant Species?	Indicator Status	Dominance Test worksheet:
1. _____	_____	_____	_____	Number of Dominant Species That Are OBL, FACW, or FAC: <u>0</u> (A)
2. _____	_____	_____	_____	Total Number of Dominant Species Across All Strata: <u>2</u> (B)
3. _____	_____	_____	_____	Percent of Dominant Species That Are OBL, FACW, or FAC: <u>0</u> (A/B)
4. _____	_____	_____	_____	
= Total Cover				
<b>Sapling/Shrub Stratum (Plot size: _____)</b>				
1. <u>Salix exigua</u>	<u>41</u>	<u>N</u>	<u>FACW</u>	<b>Prevalence Index worksheet:</b> Total % Cover of: _____ Multiply by: _____ OBL species _____ x 1 = _____ FACW species _____ x 2 = _____ FACU species _____ x 3 = _____ UPL species _____ x 5 = _____ Column Totals: _____ (A) _____ (B) Prevalence Index = B/A = _____
2. _____	_____	_____	_____	
3. _____	_____	_____	_____	
4. _____	_____	_____	_____	
5. _____	_____	_____	_____	
= Total Cover				
<b>Herb Stratum (Plot size: <u>20x20</u>)</b>				
1. <u>Brassica nigra</u>	<u>20</u>	<u>Y</u>	<u>NL</u>	<b>Hydrophytic Vegetation Indicators:</b> ___ Dominance Test is >50% ___ Prevalence Index is ≤3.0 <sup>1</sup> ___ Morphological Adaptations <sup>1</sup> (Provide supporting data in Remarks or on a separate sheet) ___ Problematic Hydrophytic Vegetation <sup>1</sup> (Explain)  <sup>1</sup> Indicators of hydric soil and wetland hydrology must be present, unless disturbed or problematic.
2. <u>Epilobium brachycarpum</u>	<u>15</u>	<u>Y</u>	<u>NL</u>	
3. <u>Rumex crispus</u>	<u>10</u>	<u>N</u>	<u>FAC</u>	
4. <u>Centaura solstitialis</u>	<u>5</u>	<u>N</u>	<u>NL</u>	
5. <u>Silybum marianum</u>	<u>3</u>	<u>N</u>	<u>NL</u>	
6. <u>Helianthus annuus</u>	<u>2</u>	<u>N</u>	<u>FACU</u>	
7. <u>Plantago lanceolata</u>	<u>5</u>	<u>N</u>	<u>FAC</u>	
8. _____	_____	_____	_____	
= Total Cover				
<b>Woody Vine Stratum (Plot size: _____)</b>				
1. _____	_____	_____	_____	<b>Hydrophytic Vegetation Present?</b> Yes _____ No <input checked="" type="checkbox"/>
2. _____	_____	_____	_____	
= Total Cover				
% Bare Ground in Herb Stratum <u>40</u> % Cover of Biotic Crust _____				
Remarks: _____				

SOIL

Sampling Point: 3

Profile Description: (Describe to the depth needed to document the indicator or confirm the absence of indicators.)

Depth (inches)	Matrix		Redox Features				Texture	Remarks
	Color (moist)	%	Color (moist)	%	Type <sup>1</sup>	Loc <sup>2</sup>		

<sup>1</sup>Type: C=Concentration, D=Depletion, RM=Reduced Matrix, CS=Covered or Coated Sand Grains. <sup>2</sup>Location: PL=Pore Lining, M=Matrix.

<b>Hydric Soil Indicators: (Applicable to all LRRs, unless otherwise noted.)</b> <input type="checkbox"/> Histosol (A1) <input type="checkbox"/> Histic Epipedon (A2) <input type="checkbox"/> Black Histic (A3) <input type="checkbox"/> Hydrogen Sulfide (A4) <input type="checkbox"/> Stratified Layers (A5) (LRR C) <input type="checkbox"/> 1 cm Muck (A9) (LRR D) <input type="checkbox"/> Depleted Below Dark Surface (A11) <input type="checkbox"/> Thick Dark Surface (A12) <input type="checkbox"/> Sandy Mucky Mineral (S1) <input type="checkbox"/> Sandy Gleyed Matrix (S4)	<input type="checkbox"/> Sandy Redox (S5) <input type="checkbox"/> Stripped Matrix (S6) <input type="checkbox"/> Loamy Mucky Mineral (F1) <input type="checkbox"/> Loamy Gleyed Matrix (F2) <input type="checkbox"/> Depleted Matrix (F3) <input type="checkbox"/> Redox Dark Surface (F6) <input type="checkbox"/> Depleted Dark Surface (F7) <input type="checkbox"/> Redox Depressions (F8) <input type="checkbox"/> Vernal Pools (F9)	<b>Indicators for Problematic Hydric Soils<sup>3</sup>:</b> <input type="checkbox"/> 1 cm Muck (A9) (LRR C) <input type="checkbox"/> 2 cm Muck (A10) (LRR B) <input type="checkbox"/> Reduced Vertic (F18) <input type="checkbox"/> Red Parent Material (TF2) <input type="checkbox"/> Other (Explain in Remarks)
--	---	--

<sup>3</sup>Indicators of hydrophytic vegetation and wetland hydrology must be present, unless disturbed or problematic.

<b>Restrictive Layer (if present):</b> Type: _____ Depth (Inches): _____	Hydric Soil Present? Yes _____ No _____
--	---

Remarks: No soil pit - sample point is at the bottom of sewage basin that has no wetland hydrology and is dominated by upland vegetation.

HYDROLOGY

<b>Wetland Hydrology Indicators:</b> Primary Indicators (minimum of one required; check all that apply)			Secondary Indicators (2 or more required)		
<input type="checkbox"/> Surface Water (A1)	<input type="checkbox"/> Salt Crust (B11)	<input type="checkbox"/> Water Marks (B1) (Riverine)	<input type="checkbox"/> High Water Table (A2)	<input type="checkbox"/> Biotic Crust (B12)	<input type="checkbox"/> Sediment Deposits (B2) (Riverine)
<input type="checkbox"/> Saturation (A3)	<input type="checkbox"/> Aquatic Invertebrates (B13)	<input type="checkbox"/> Drift Deposits (B3) (Riverine)	<input type="checkbox"/> Water Marks (B1) (Nonriverine)	<input type="checkbox"/> Hydrogen Sulfide Odor (C1)	<input type="checkbox"/> Drainage Patterns (B10)
<input type="checkbox"/> Sediment Deposits (B2) (Nonriverine)	<input type="checkbox"/> Oxidized Rhizospheres along Living Roots (C3)	<input type="checkbox"/> Dry-Season Water Table (C2)	<input type="checkbox"/> Drift Deposits (B3) (Nonriverine)	<input type="checkbox"/> Presence of Reduced Iron (C4)	<input type="checkbox"/> Crayfish Burrows (C8)
<input type="checkbox"/> Surface Soil Cracks (B6)	<input type="checkbox"/> Recent Iron Reduction in Tilled Soils (C6)	<input type="checkbox"/> Saturation Visible on Aerial Imagery (C9)	<input type="checkbox"/> Inundation Visible on Aerial Imagery (B7)	<input type="checkbox"/> Thin Muck Surface (C7)	<input type="checkbox"/> Shallow Aquitard (D3)
<input type="checkbox"/> Water-Stained Leaves (B9)	<input type="checkbox"/> Other (Explain in Remarks)	<input type="checkbox"/> FAC-Neutral Test (D5)			

<b>Field Observations:</b> Surface Water Present? Yes _____ No <input checked="" type="checkbox"/> Water Table Present? Yes _____ No <input checked="" type="checkbox"/> Saturation Present? (includes capillary fringe) Yes _____ No <input checked="" type="checkbox"/> Depth (inches): _____ Depth (inches): _____ Depth (inches): _____	Wetland Hydrology Present? Yes _____ No <input checked="" type="checkbox"/>
---	---

Describe Recorded Data (stream gauge, monitoring well, aerial photos, previous inspections), if available:

Remarks: Overflow basin, no OHW and no wetland hydrology

**WETLAND DETERMINATION DATA FORM – Arid West Region**

Project/Site: Crow's Landing City/County: Stanislaus Sampling Date: 11/26/13  
 Applicant/Owner: Stanislaus County State: CA Sampling Point: 4  
 Investigator(s): T. Beyerl, Y. Valle Section, Township, Range: \_\_\_\_\_  
 Landform (hillslope, terrace, etc.): terrace Local relief (concave, convex, none): none Slope (%): 2  
 Subregion (LRR): LRRC Lat: 37°25'40.36" N Long: 121°06'05.68" W Datum: \_\_\_\_\_  
 Soil Map Unit Name: Capay clay, 0 to 2% slopes, rarely flooded NWI classification: \_\_\_\_\_  
 Are climatic / hydrologic conditions on the site typical for this time of year? Yes  No \_\_\_\_\_ (If no, explain in Remarks.)  
 Are Vegetation N, Soil N, or Hydrology N significantly disturbed? Are "Normal Circumstances" present? Yes  No \_\_\_\_\_  
 Are Vegetation N, Soil N, or Hydrology N naturally problematic? (If needed, explain any answers in Remarks.)

**SUMMARY OF FINDINGS – Attach site map showing sampling point locations, transects, important features, etc.**

Hydrophytic Vegetation Present?	Yes <input checked="" type="checkbox"/>	No _____	Is the Sampled Area within a Wetland? Yes <input checked="" type="checkbox"/> No _____
Hydric Soil Present?	Yes <input checked="" type="checkbox"/>	No _____	
Wetland Hydrology Present?	Yes <input checked="" type="checkbox"/>	No _____	
Remarks: <u>Photo #4816-4821 Created basin with willows on the basin floor; created habitat.</u>			

**VEGETATION – Use scientific names of plants.**

Tree Stratum (Plot size: <u>40x40</u> )	Absolute % Cover	Dominant Species?	Indicator Status	Dominance Test worksheet:
1. <u>Salix gooddingii</u>	<u>15</u>	<u>Y</u>	<u>FACW</u>	Number of Dominant Species That Are OBL, FACW, or FAC: <u>3</u> (A)
2. _____	_____	_____	_____	Total Number of Dominant Species Across All Strata: <u>3</u> (B)
3. _____	_____	_____	_____	Percent of Dominant Species That Are OBL, FACW, or FAC: <u>100</u> (A/B)
4. _____	_____	_____	_____	<b>Prevalence Index worksheet:</b> Total % Cover of: _____ Multiply by: _____ OBL species _____ x 1 = _____ FACW species _____ x 2 = _____ FAC species _____ x 3 = _____ FACU species _____ x 4 = _____ UPL species _____ x 5 = _____ Column Totals: _____ (A) _____ (B) Prevalence Index = B/A = _____
= Total Cover				
<b>Sapling/Shrub Stratum (Plot size: <u>40x40</u>)</b>				
1. <u>Salix exigua</u>	<u>35</u>	<u>Y</u>	<u>FACW</u>	
2. <u>Salix gooddingii</u>	<u>10</u>	<u>Y</u>	<u>FACW</u>	
<u>45</u> = Total Cover				
<b>Herb Stratum (Plot size: _____)</b>				
1. _____	_____	_____	_____	
2. _____	_____	_____	_____	
3. _____	_____	_____	_____	
4. _____	_____	_____	_____	
5. _____	_____	_____	_____	
6. _____	_____	_____	_____	
7. _____	_____	_____	_____	
8. _____	_____	_____	_____	
= Total Cover				
<b>Woody Vine Stratum (Plot size: _____)</b>				
1. _____	_____	_____	_____	
2. _____	_____	_____	_____	
= Total Cover				
% Bare Ground in Herb Stratum <u>100</u>		% Cover of Biotic Crust _____		
Hydrophytic Vegetation Present? Yes <input checked="" type="checkbox"/> No _____				
Remarks: <u>ground covered with willow leaves and branches, no herb cover.</u>				

**SOIL**

Sampling Point: 4

**Profile Description: (Describe to the depth needed to document the indicator or confirm the absence of indicators.)**

Depth (inches)	Matrix		Redox Features				Texture	Remarks
	Color (moist)	%	Color (moist)	%	Type <sup>1</sup>	Loc <sup>2</sup>		
0-6	10YR 3/2	95	5YR 4/6	5	C	PL	CL	coarse, blocky soil
6-20	10YR 3/3	80	5YR 4/6	20	C	PL, M	CL	

<sup>1</sup>Type: C=Concentration, D=Depletion, RM=Reduced Matrix, CS=Covered or Coated Sand Grains.      <sup>2</sup>Location: PL=Pore Lining, M=Matrix.

**Hydric Soil Indicators: (Applicable to all LRRs, unless otherwise noted.)**

<input type="checkbox"/> Histosol (A1)	<input type="checkbox"/> Sandy Redox (S5)	<input type="checkbox"/> 1 cm Muck (A9) (LRR C)
<input type="checkbox"/> Histic Epipedon (A2)	<input type="checkbox"/> Stripped Matrix (S6)	<input type="checkbox"/> 2 cm Muck (A10) (LRR B)
<input type="checkbox"/> Black Histic (A3)	<input type="checkbox"/> Loamy Mucky Mineral (F1)	<input type="checkbox"/> Reduced Vertic (F18)
<input type="checkbox"/> Hydrogen Sulfide (A4)	<input type="checkbox"/> Loamy Gleyed Matrix (F2)	<input type="checkbox"/> Red Parent Material (TF2)
<input type="checkbox"/> Stratified Layers (A5) (LRR C)	<input type="checkbox"/> Depleted Matrix (F3)	<input type="checkbox"/> Other (Explain in Remarks)
<input type="checkbox"/> 1 cm Muck (A9) (LRR D)	<input checked="" type="checkbox"/> Redox Dark Surface (F6)	
<input type="checkbox"/> Depleted Below Dark Surface (A11)	<input type="checkbox"/> Depleted Dark Surface (F7)	
<input type="checkbox"/> Thick Dark Surface (A12)	<input type="checkbox"/> Redox Depressions (F8)	
<input type="checkbox"/> Sandy Mucky Mineral (S1)	<input type="checkbox"/> Vernal Pools (F9)	
<input type="checkbox"/> Sandy Gleyed Matrix (S4)		

<sup>3</sup>Indicators of hydrophytic vegetation and wetland hydrology must be present, unless disturbed or problematic.

**Restrictive Layer (if present):**

Type: \_\_\_\_\_

Depth (inches): \_\_\_\_\_

Hydric Soil Present? Yes  No \_\_\_\_\_

Remarks:

**HYDROLOGY**

**Wetland Hydrology Indicators:**

<u>Primary Indicators (minimum of one required; check all that apply)</u>		<u>Secondary Indicators (2 or more required)</u>
<input type="checkbox"/> Surface Water (A1)	<input type="checkbox"/> Salt Crust (B11)	<input type="checkbox"/> Water Marks (B1) (Riverine)
<input type="checkbox"/> High Water Table (A2)	<input type="checkbox"/> Biotic Crust (B12)	<input type="checkbox"/> Sediment Deposits (B2) (Riverine)
<input type="checkbox"/> Saturation (A3)	<input type="checkbox"/> Aquatic Invertebrates (B13)	<input type="checkbox"/> Drift Deposits (B3) (Riverine)
<input type="checkbox"/> Water Marks (B1) (Nonriverine)	<input type="checkbox"/> Hydrogen Sulfide Odor (C1)	<input type="checkbox"/> Drainage Patterns (B10)
<input type="checkbox"/> Sediment Deposits (B2) (Nonriverine)	<input checked="" type="checkbox"/> Oxidized Rhizospheres along Living Roots (C3)	<input type="checkbox"/> Dry-Season Water Table (C2)
<input type="checkbox"/> Drift Deposits (B3) (Nonriverine)	<input type="checkbox"/> Presence of Reduced Iron (C4)	<input type="checkbox"/> Crayfish Burrows (C8)
<input type="checkbox"/> Surface Soil Cracks (B6)	<input type="checkbox"/> Recent Iron Reduction in Tilled Soils (C6)	<input type="checkbox"/> Saturation Visible on Aerial Imagery (C9)
<input type="checkbox"/> Inundation Visible on Aerial Imagery (B7)	<input type="checkbox"/> Thin Muck Surface (C7)	<input type="checkbox"/> Shallow Aquitard (D3)
<input type="checkbox"/> Water-Stained Leaves (B9)	<input type="checkbox"/> Other (Explain in Remarks)	<input type="checkbox"/> FAC-Neutral Test (D5)

**Field Observations:**

Surface Water Present? Yes \_\_\_\_\_ No  Depth (inches): \_\_\_\_\_

Water Table Present? Yes \_\_\_\_\_ No  Depth (inches): \_\_\_\_\_

Saturation Present? (Includes capillary fringe) Yes \_\_\_\_\_ No  Depth (inches): \_\_\_\_\_

Wetland Hydrology Present? Yes  No \_\_\_\_\_

Describe Recorded Data (stream gauge, monitoring well, aerial photos, previous inspections), if available:

Remarks: Point is within an excavated basin adjacent to irrigation canal; connected by control gate.

**WETLAND DETERMINATION DATA FORM – Arid West Region**

Project/Site: Crow's Landing City/County: Stanislaus Sampling Date: 11/26/13  
 Applicant/Owner: Stanislaus County State: CA Sampling Point: 5  
 Investigator(s): T. Beyerl, P. Valle Section, Township, Range: \_\_\_\_\_  
 Landform (hillslope, terrace, etc.): terrace Local relief (concave, convex, none): none Slope (%): 2  
 Subregion (LRR): LRRC Lat: 37°25'38.75" N Long: 121°06'04.55" W Datum: \_\_\_\_\_  
 Soil Map Unit Name: Capay clay, 0 to 2% slopes, rarely flooded NWI classification: \_\_\_\_\_  
 Are climatic / hydrologic conditions on the site typical for this time of year? Yes  No \_\_\_\_\_ (If no, explain in Remarks.)  
 Are Vegetation N, Soil N, or Hydrology N significantly disturbed? Are "Normal Circumstances" present? Yes  No \_\_\_\_\_  
 Are Vegetation N, Soil N, or Hydrology N naturally problematic? (If needed, explain any answers in Remarks.)

**SUMMARY OF FINDINGS – Attach site map showing sampling point locations, transects, important features, etc.**

Hydrophytic Vegetation Present? Yes _____ No <input checked="" type="checkbox"/> Hydric Soil Present? Yes _____ No <input checked="" type="checkbox"/> Wetland Hydrology Present? Yes _____ No <input checked="" type="checkbox"/>	Is the Sampled Area within a Wetland? Yes _____ No <input checked="" type="checkbox"/>
Remarks: <u>Photo # 4822-4825</u> <u>Point is on top of bank beside basin containing willow scrub vegetation.</u>	

**VEGETATION – Use scientific names of plants.**

Tree Stratum (Plot size: _____)	Absolute % Cover	Dominant Species?	Indicator Status	Dominance Test worksheet:
1. _____	_____	_____	_____	Number of Dominant Species That Are OBL, FACW, or FAC: <u>1</u> (A)
2. _____	_____	_____	_____	Total Number of Dominant Species Across All Strata: <u>3</u> (B)
3. _____	_____	_____	_____	Percent of Dominant Species That Are OBL, FACW, or FAC: <u>33</u> (A/B)
4. _____	_____	_____	_____	Prevalence Index worksheet: Total % Cover of: _____ Multiply by: _____ OBL species _____ x 1 = _____ FACW species _____ x 2 = _____ FAC species _____ x 3 = _____ FACU species _____ x 4 = _____ UPL species _____ x 5 = _____ Column Totals: _____ (A) _____ (B) Prevalence Index = B/A = _____
Sapling/Shrub Stratum (Plot size: <u>20x20</u> ) = Total Cover				
1. <u>Atropis lenticiformis</u>	<u>80</u>	<u>Y</u>	<u>FAC</u>	Hydrophytic Vegetation Indicators: ___ Dominance Test is >50% ___ Prevalence Index is ≤3.0 <sup>1</sup> ___ Morphological Adaptations <sup>1</sup> (Provide supporting data in Remarks or on a separate sheet) ___ Problematic Hydrophytic Vegetation <sup>1</sup> (Explain)  <sup>1</sup> Indicators of hydric soil and wetland hydrology must be present, unless disturbed or problematic.
2. _____	_____	_____	_____	
3. _____	_____	_____	_____	
4. _____	_____	_____	_____	
5. _____	_____	_____	_____	
Herb Stratum (Plot size: <u>20x20</u> ) = Total Cover				
1. <u>Silybum marianum</u>	<u>10</u>	<u>Y</u>	<u>NL</u>	
2. <u>Melilotus indicus</u>	<u>5</u>	<u>Y</u>	<u>FACU</u>	
3. _____	_____	_____	_____	
4. _____	_____	_____	_____	
5. _____	_____	_____	_____	
6. _____	_____	_____	_____	
7. _____	_____	_____	_____	
8. _____	_____	_____	_____	
Woody Vine Stratum (Plot size: _____) = Total Cover				
1. _____	_____	_____	_____	Hydrophytic Vegetation Present? Yes _____ No <input checked="" type="checkbox"/>
2. _____	_____	_____	_____	
% Bare Ground in Herb Stratum <u>85</u> % Cover of Biotic Crust _____				
Remarks:				

**SOIL**

Sampling Point: 5

**Profile Description: (Describe to the depth needed to document the indicator or confirm the absence of indicators.)**

Depth (inches)	Matrix		Redox Features				Texture	Remarks
	Color (moist)	%	Color (moist)	%	Type <sup>1</sup>	Loc <sup>2</sup>		
0-20	10YR 3/3	65	5YR 4/8	35	C	M	CL	blacky soil

<sup>1</sup>Type: C=Concentration, D=Depletion, RM=Reduced Matrix, CS=Covered or Coated Sand Grains.      <sup>2</sup>Location: PL=Pore Lining, M=Matrix.

**Hydric Soil Indicators: (Applicable to all LRRs, unless otherwise noted.)**

<input type="checkbox"/> Histosol (A1)	<input type="checkbox"/> Sandy Redox (S5)	<input type="checkbox"/> 1 cm Muck (A9) (LRR C)
<input type="checkbox"/> Histic Epipedon (A2)	<input type="checkbox"/> Stripped Matrix (S6)	<input type="checkbox"/> 2 cm Muck (A10) (LRR B)
<input type="checkbox"/> Black Histic (A3)	<input type="checkbox"/> Loamy Mucky Mineral (F1)	<input type="checkbox"/> Reduced Vertic (F18)
<input type="checkbox"/> Hydrogen Sulfide (A4)	<input type="checkbox"/> Loamy Gleyed Matrix (F2)	<input type="checkbox"/> Red Parent Material (TF2)
<input type="checkbox"/> Stratified Layers (A5) (LRR C)	<input type="checkbox"/> Depleted Matrix (F3)	<input type="checkbox"/> Other (Explain in Remarks)
<input type="checkbox"/> 1 cm Muck (A9) (LRR D)	<input type="checkbox"/> Redox Dark Surface (F6)	
<input type="checkbox"/> Depleted Below Dark Surface (A11)	<input type="checkbox"/> Depleted Dark Surface (F7)	
<input type="checkbox"/> Thick Dark Surface (A12)	<input type="checkbox"/> Redox Depressions (F8)	
<input type="checkbox"/> Sandy Mucky Mineral (S1)	<input type="checkbox"/> Vernal Pools (F9)	
<input type="checkbox"/> Sandy Gleyed Matrix (S4)		

<sup>3</sup>Indicators of hydrophytic vegetation and wetland hydrology must be present, unless disturbed or problematic.

**Restrictive Layer (if present):**  
 Type: \_\_\_\_\_  
 Depth (inches): \_\_\_\_\_

Hydric Soil Present? Yes \_\_\_\_\_ No

Remarks: concentrations are relict features with abrupt angular boundaries and extremely firm texture.

**HYDROLOGY**

**Wetland Hydrology Indicators:**

<u>Primary Indicators (minimum of one required; check all that apply)</u>		<u>Secondary Indicators (2 or more required)</u>
<input type="checkbox"/> Surface Water (A1)	<input type="checkbox"/> Salt Crust (B11)	<input type="checkbox"/> Water Marks (B1) (Riverine)
<input type="checkbox"/> High Water Table (A2)	<input type="checkbox"/> Biotic Crust (B12)	<input type="checkbox"/> Sediment Deposits (B2) (Riverine)
<input type="checkbox"/> Saturation (A3)	<input type="checkbox"/> Aquatic Invertebrates (B13)	<input type="checkbox"/> Drift Deposits (B3) (Riverine)
<input type="checkbox"/> Water Marks (B1) (Nonriverine)	<input type="checkbox"/> Hydrogen Sulfide Odor (C1)	<input type="checkbox"/> Drainage Patterns (B10)
<input type="checkbox"/> Sediment Deposits (B2) (Nonriverine)	<input type="checkbox"/> Oxidized Rhizospheres along Living Roots (C3)	<input type="checkbox"/> Dry-Season Water Table (C2)
<input type="checkbox"/> Drift Deposits (B3) (Nonriverine)	<input type="checkbox"/> Presence of Reduced Iron (C4)	<input type="checkbox"/> Crayfish Burrows (C8)
<input type="checkbox"/> Surface Soil Cracks (B6)	<input type="checkbox"/> Recent Iron Reduction in Tilled Soils (C6)	<input type="checkbox"/> Saturation Visible on Aerial Imagery (C9)
<input type="checkbox"/> Inundation Visible on Aerial Imagery (B7)	<input type="checkbox"/> Thin Muck Surface (C7)	<input type="checkbox"/> Shallow Aquitard (D3)
<input type="checkbox"/> Water-Stained Leaves (B9)	<input type="checkbox"/> Other (Explain in Remarks)	<input type="checkbox"/> FAC-Neutral Test (D5)

**Field Observations:**

Surface Water Present? Yes _____ No <input checked="" type="checkbox"/>	Depth (inches): _____	Wetland Hydrology Present? Yes _____ No <input checked="" type="checkbox"/>
Water Table Present? Yes _____ No <input checked="" type="checkbox"/>	Depth (inches): _____	
Saturation Present? Yes _____ No <input checked="" type="checkbox"/> (includes capillary fringe)	Depth (inches): _____	

Describe Recorded Data (stream gauge, monitoring well, aerial photos, previous inspections), if available:

Remarks:

**WETLAND DETERMINATION DATA FORM – Arid West Region**

Project/Site: Crow's Landing City/County: Stanislaus Sampling Date: 11/26/13  
 Applicant/Owner: Stanislaus County State: CA Sampling Point: 6  
 Investigator(s): T. Beyerl, P. Valle Section, Township, Range: \_\_\_\_\_  
 Landform (hillslope, terrace, etc.): terrace Local relief (concave, convex, none): none Slope (%): 0  
 Subregion (LRR): LRRC Lat: 37°24'55.16" N Long: 121°06'31.62" W Datum: \_\_\_\_\_  
 Soil Map Unit Name: Capay clay, 0 to 2% slopes, rarely flooded NWI classification: \_\_\_\_\_  
 Are climatic / hydrologic conditions on the site typical for this time of year? Yes  No \_\_\_\_\_ (If no, explain in Remarks.)  
 Are Vegetation N, Soil N, or Hydrology N significantly disturbed? Are "Normal Circumstances" present? Yes  No \_\_\_\_\_  
 Are Vegetation N, Soil N, or Hydrology N naturally problematic? (If needed, explain any answers in Remarks.)

**SUMMARY OF FINDINGS – Attach site map showing sampling point locations, transects, important features, etc.**

Hydrophytic Vegetation Present?	Yes <input checked="" type="checkbox"/>	No _____	Is the Sampled Area within a Wetland? Yes _____ No <input checked="" type="checkbox"/>
Hydric Soil Present?	Yes _____	No _____	
Wetland Hydrology Present?	Yes <input checked="" type="checkbox"/>	No _____	
Remarks: <u>Photos 4826-4828</u> <u>canal/channelized creek (Little Salado creek)</u>			

**VEGETATION – Use scientific names of plants.**

Tree Stratum (Plot size: _____)	Absolute % Cover	Dominant Species?	Indicator Status	Dominance Test worksheet:
1. _____				Number of Dominant Species That Are OBL, FACW, or FAC: <u>2</u> (A)
2. _____				Total Number of Dominant Species Across All Strata: <u>2</u> (B)
3. _____				Percent of Dominant Species That Are OBL, FACW, or FAC: <u>100</u> (A/B)
4. _____				
_____ = Total Cover				Prevalence Index worksheet: Total % Cover of: _____ Multiply by: _____ OBL species _____ x 1 = _____ FACW species _____ x 2 = _____ FAC species _____ x 3 = _____ FACU species _____ x 4 = _____ UPL species _____ x 5 = _____ Column Totals: _____ (A) _____ (B) Prevalence Index = B/A = _____
Sapling/Shrub Stratum (Plot size: _____)				
1. _____				
2. _____				
3. _____				
_____ = Total Cover				
Herb Stratum (Plot size: <u>10x10</u> )				
1. <u>Panicum punctata</u>	<u>30</u>	<u>Y</u>	<u>OBL</u>	
2. <u>Echinochloa crus-galli</u>	<u>25</u>	<u>Y</u>	<u>FACW</u>	
3. <u>Sorghum halapense</u>	<u>15</u>	<u>N</u>	<u>FACU</u>	
4. <u>Cyperus eragrostis</u>	<u>10</u>	<u>N</u>	<u>FACW</u>	
5. <u>Echinochloa brachycarpum</u>	<u>10</u>	<u>N</u>	<u>NL</u>	
6. <u>Hemithoeca echinoides</u>	<u>2</u>	<u>N</u>	<u>FACU</u>	
7. <u>Silybum marianum</u>	<u>2</u>	<u>N</u>	<u>NL</u>	
8. <u>Brassica nigra</u>	<u>1</u>	<u>N</u>	<u>NL</u>	
<u>95</u> = Total Cover				
Woody Vine Stratum (Plot size: _____)				
1. _____				
2. _____				
_____ = Total Cover				
% Bare Ground in Herb Stratum <u>5</u>		% Cover of Biotic Crust _____		
Hydrophytic Vegetation Present? Yes <input checked="" type="checkbox"/> No _____				
Remarks: <u>Willows are present downstream of this point.</u>				

**SOIL**

Sampling Point: 6

**Profile Description: (Describe to the depth needed to document the indicator or confirm the absence of indicators.)**

Depth (inches)	Matrix		Redox Features				Texture	Remarks
	Color (moist)	%	Color (moist)	%	Type <sup>1</sup>	Loc <sup>2</sup>		
							Clay	

<sup>1</sup>Type: C=Concentration, D=Depletion, RM=Reduced Matrix, CS=Covered or Coated Sand Grains.    <sup>2</sup>Location: PL=Pore Lining, M=Matrix.

Hydric Soil Indicators: (Applicable to all LRRs, unless otherwise noted.)		Indicators for Problematic Hydric Soils <sup>3</sup> :	
<input type="checkbox"/> Histosol (A1)	<input type="checkbox"/> Sandy Redox (S5)	<input type="checkbox"/> 1 cm Muck (A9) (LRR C)	
<input type="checkbox"/> Histic Epipedon (A2)	<input type="checkbox"/> Stripped Matrix (S6)	<input type="checkbox"/> 2 cm Muck (A10) (LRR B)	
<input type="checkbox"/> Black Histic (A3)	<input type="checkbox"/> Loamy Mucky Mineral (F1)	<input type="checkbox"/> Reduced Vertic (F18)	
<input type="checkbox"/> Hydrogen Sulfide (A4)	<input type="checkbox"/> Loamy Gleyed Matrix (F2)	<input type="checkbox"/> Red Parent Material (TF2)	
<input type="checkbox"/> Stratified Layers (A5) (LRR C)	<input type="checkbox"/> Depleted Matrix (F3)	<input type="checkbox"/> Other (Explain in Remarks)	
<input type="checkbox"/> 1 cm Muck (A9) (LRR D)	<input type="checkbox"/> Redox Dark Surface (F6)		
<input type="checkbox"/> Depleted Below Dark Surface (A11)	<input type="checkbox"/> Depleted Dark Surface (F7)		
<input type="checkbox"/> Thick Dark Surface (A12)	<input type="checkbox"/> Redox Depressions (F8)		
<input type="checkbox"/> Sandy Mucky Mineral (S1)	<input type="checkbox"/> Vernal Pools (F9)		
<input type="checkbox"/> Sandy Gleyed Matrix (S4)			

<sup>3</sup>Indicators of hydrophytic vegetation and wetland hydrology must be present, unless disturbed or problematic.

**Restrictive Layer (if present):**  
 Type: \_\_\_\_\_  
 Depth (inches): \_\_\_\_\_

Hydric Soil Present? Yes  No \_\_\_\_\_

Assumed hydric

Remarks: No soil pit - point is within the OTHWM of a channelized creek

**HYDROLOGY**

**Wetland Hydrology Indicators:**

Primary Indicators (minimum of one required; check all that apply)		Secondary Indicators (2 or more required)	
<input type="checkbox"/> Surface Water (A1)	<input type="checkbox"/> Salt Crust (B11)	<input type="checkbox"/> Water Marks (B1) (Riverine)	
<input type="checkbox"/> High Water Table (A2)	<input type="checkbox"/> Biotic Crust (B12)	<input type="checkbox"/> Sediment Deposits (B2) (Riverine)	
<input type="checkbox"/> Saturation (A3)	<input type="checkbox"/> Aquatic Invertebrates (B13)	<input type="checkbox"/> Drift Deposits (B3) (Riverine)	
<input type="checkbox"/> Water Marks (B1) (Nonriverine)	<input type="checkbox"/> Hydrogen Sulfide Odor (C1)	<input checked="" type="checkbox"/> Drainage Patterns (B10)	
<input type="checkbox"/> Sediment Deposits (B2) (Nonriverine)	<input type="checkbox"/> Oxidized Rhizospheres along Living Roots (C3)	<input type="checkbox"/> Dry-Season Water Table (C2)	
<input type="checkbox"/> Drift Deposits (B3) (Nonriverine)	<input type="checkbox"/> Presence of Reduced Iron (C4)	<input type="checkbox"/> Crayfish Burrows (C8)	
<input checked="" type="checkbox"/> Surface Soil Cracks (B6)	<input type="checkbox"/> Recent Iron Reduction in Tilled Soils (C6)	<input type="checkbox"/> Saturation Visible on Aerial Imagery (C9)	
<input type="checkbox"/> Inundation Visible on Aerial Imagery (B7)	<input type="checkbox"/> Thin Muck Surface (C7)	<input type="checkbox"/> Shallow Aquitard (D3)	
<input type="checkbox"/> Water-Stained Leaves (B9)	<input type="checkbox"/> Other (Explain in Remarks)	<input type="checkbox"/> FAC-Neutral Test (D5)	

**Field Observations:**

Surface Water Present? Yes \_\_\_\_\_ No  Depth (inches): \_\_\_\_\_

Water Table Present? Yes \_\_\_\_\_ No  Depth (inches): \_\_\_\_\_

Saturation Present? (includes capillary fringe) Yes \_\_\_\_\_ No  Depth (inches): \_\_\_\_\_

Wetland Hydrology Present? Yes  No \_\_\_\_\_

Describe Recorded Data (stream gauge, monitoring well, aerial photos, previous inspections), if available:

Remarks:



**WETLAND DETERMINATION DATA FORM – Arid West Region**

Project/Site: Crow's Landing City/County: Stanislaus Sampling Date: 11/26/13  
 Applicant/Owner: Stanislaus County State: CA Sampling Point: 7  
 Investigator(s): T. Beyerl, P. Valle Section, Township, Range: \_\_\_\_\_  
 Landform (hillslope, terrace, etc.): terrace Local relief (concave, convex, none): none Slope (%): 0  
 Subregion (LRR): LRRC Lat: 37° 24' 54.43" N Long: 121° 06' 53.95" W Datum: \_\_\_\_\_  
 Soil Map Unit Name: Capay clay, 0 to 2% slopes NWI classification: \_\_\_\_\_  
 Are climatic / hydrologic conditions on the site typical for this time of year? Yes  No \_\_\_\_\_ (If no, explain in Remarks.)  
 Are Vegetation N, Soil N, or Hydrology N significantly disturbed? Are "Normal Circumstances" present? Yes  No \_\_\_\_\_  
 Are Vegetation N, Soil N, or Hydrology N naturally problematic? (If needed, explain any answers in Remarks.)

**SUMMARY OF FINDINGS – Attach site map showing sampling point locations, transects, important features, etc.**

Hydrophytic Vegetation Present? Yes _____ No <input checked="" type="checkbox"/> Hydric Soil Present? Yes _____ No <input checked="" type="checkbox"/> Wetland Hydrology Present? Yes _____ No <input checked="" type="checkbox"/>	Is the Sampled Area within a Wetland? Yes _____ No <input checked="" type="checkbox"/>
Remarks: <u>4836-4838 upland ruderal field within fenced area that was a former firing range.</u>	

**VEGETATION – Use scientific names of plants.**

Tree Stratum (Plot size: _____)	Absolute % Cover	Dominant Species?	Indicator Status	Dominance Test worksheet:
1. _____				Number of Dominant Species That Are OBL, FACW, or FAC: _____ (A)
2. _____				Total Number of Dominant Species Across All Strata: _____ (B)
3. _____				Percent of Dominant Species That Are OBL, FACW, or FAC: _____ (A/B)
4. _____				
_____ = Total Cover				
Sapling/Shrub Stratum (Plot size: _____)	Absolute % Cover	Dominant Species?	Indicator Status	Prevalence Index worksheet:
1. _____				Total % Cover of: _____ Multiply by: _____
2. _____				OBL species _____ x 1 = _____
3. _____				FACW species _____ x 2 = _____
4. _____				FAC species _____ x 3 = _____
5. _____				FACU species _____ x 4 = _____
				UPL species _____ x 5 = _____
_____ = Total Cover				Column Totals: _____ (A) _____ (B)
				Prevalence Index = B/A = _____
Herb Stratum (Plot size: <u>20x20</u> )	Absolute % Cover	Dominant Species?	Indicator Status	Hydrophytic Vegetation Indicators:
1. <u>Avena sativa</u>	<u>25</u>	<u>Y</u>	<u>UPL</u>	_____ Dominance Test is >50%
2. <u>Bromus diandrus</u>	<u>15</u>	<u>Y</u>	<u>UPL</u>	_____ Prevalence Index is ≤3.0 <sup>1</sup>
3. <u>Festuca myuros</u>	<u>25</u>	<u>Y</u>	<u>FACW</u>	_____ Morphological Adaptations <sup>1</sup> (Provide supporting data in Remarks or on a separate sheet)
4. <u>Amisotkia intermedia</u>	<u>10</u>	<u>N</u>	<u>NL</u>	_____ Problematic Hydrophytic Vegetation <sup>1</sup> (Explain)
5. <u>Medicago polymorpha</u>	<u>10</u>	<u>N</u>	<u>FACW</u>	
6. <u>Hordeum murinum</u>	<u>5</u>	<u>N</u>	<u>FACW</u>	
7. <u>Carduus pycnocephalus</u>	<u>2</u>	<u>N</u>	<u>NL</u>	
8. <u>Convolvulus arvensis</u>	<u>1</u>	<u>N</u>	<u>NL</u>	
Other <u>2%</u>	<u>95</u>			
_____ = Total Cover				
Woody Vine Stratum (Plot size: _____)	Absolute % Cover	Dominant Species?	Indicator Status	Hydrophytic Vegetation Present?
1. _____				Yes _____ No <input checked="" type="checkbox"/>
2. _____				
_____ = Total Cover				
% Bare Ground in Herb Stratum <u>5</u> % Cover of Biotic Crust _____				
Remarks: _____				

**SOIL**

Sampling Point: 7

**Profile Description: (Describe to the depth needed to document the indicator or confirm the absence of indicators.)**

Depth (inches)	Matrix		Redox Features				Texture	Remarks
	Color (moist)	%	Color (moist)	%	Type <sup>1</sup>	Loc <sup>2</sup>		

<sup>1</sup>Type: C=Concentration, D=Depletion, RM=Reduced Matrix, CS=Covered or Coated Sand Grains.      <sup>2</sup>Location: PL=Pore Lining, M=Matrix.

<b>Hydric Soil Indicators: (Applicable to all LRRs, unless otherwise noted.)</b>		<b>Indicators for Problematic Hydric Soils<sup>3</sup>:</b>
<input type="checkbox"/> Histosol (A1)	<input type="checkbox"/> Sandy Redox (S5)	<input type="checkbox"/> 1 cm Muck (A9) (LRR C)
<input type="checkbox"/> Histic Epipedon (A2)	<input type="checkbox"/> Stripped Matrix (S6)	<input type="checkbox"/> 2 cm Muck (A10) (LRR B)
<input type="checkbox"/> Black Histic (A3)	<input type="checkbox"/> Loamy Mucky Mineral (F1)	<input type="checkbox"/> Reduced Vertic (F18)
<input type="checkbox"/> Hydrogen Sulfide (A4)	<input type="checkbox"/> Loamy Gleyed Matrix (F2)	<input type="checkbox"/> Red Parent Material (TF2)
<input type="checkbox"/> Stratified Layers (A5) (LRR C)	<input type="checkbox"/> Depleted Matrix (F3)	<input type="checkbox"/> Other (Explain in Remarks)
<input type="checkbox"/> 1 cm Muck (A9) (LRR D)	<input type="checkbox"/> Redox Dark Surface (F6)	
<input type="checkbox"/> Depleted Below Dark Surface (A11)	<input type="checkbox"/> Depleted Dark Surface (F7)	
<input type="checkbox"/> Thick Dark Surface (A12)	<input type="checkbox"/> Redox Depressions (F8)	
<input type="checkbox"/> Sandy Mucky Mineral (S1)	<input type="checkbox"/> Vernal Pools (F9)	
<input type="checkbox"/> Sandy Gleyed Matrix (S4)		

<sup>3</sup>Indicators of hydrophytic vegetation and wetland hydrology must be present, unless disturbed or problematic.

<b>Restrictive Layer (if present):</b> Type: _____ Depth (inches): _____	<b>Hydric Soil Present?</b> Yes _____ No _____
--	--

Remarks: *No soil pit - no hydrophytic vegetation or wetland hydrology and site was formerly used for a firing range and munitions could be present so may not be safe to dig.*

**HYDROLOGY**

<b>Wetland Hydrology Indicators:</b>	
<b>Primary Indicators (minimum of one required; check all that apply)</b>	<b>Secondary Indicators (2 or more required)</b>
<input type="checkbox"/> Surface Water (A1)	<input type="checkbox"/> Salt Crust (B11)
<input type="checkbox"/> High Water Table (A2)	<input type="checkbox"/> Biotic Crust (B12)
<input type="checkbox"/> Saturation (A3)	<input type="checkbox"/> Aquatic Invertebrates (B13)
<input type="checkbox"/> Water Marks (B1) (Nonriverine)	<input type="checkbox"/> Hydrogen Sulfide Odor (C1)
<input type="checkbox"/> Sediment Deposits (B2) (Nonriverine)	<input type="checkbox"/> Oxidized Rhizospheres along Living Roots (C3)
<input type="checkbox"/> Drift Deposits (B3) (Nonriverine)	<input type="checkbox"/> Presence of Reduced Iron (C4)
<input type="checkbox"/> Surface Soil Cracks (B6)	<input type="checkbox"/> Recent Iron Reduction in Tilled Soils (C6)
<input type="checkbox"/> Inundation Visible on Aerial Imagery (B7)	<input type="checkbox"/> Thin Muck Surface (C7)
<input type="checkbox"/> Water-Stained Leaves (B9)	<input type="checkbox"/> Other (Explain in Remarks)
	<input type="checkbox"/> Water Marks (B1) (Riverine)
	<input type="checkbox"/> Sediment Deposits (B2) (Riverine)
	<input type="checkbox"/> Drift Deposits (B3) (Riverine)
	<input type="checkbox"/> Drainage Patterns (B10)
	<input type="checkbox"/> Dry-Season Water Table (C2)
	<input type="checkbox"/> Crayfish Burrows (C8)
	<input type="checkbox"/> Saturation Visible on Aerial Imagery (C9)
	<input type="checkbox"/> Shallow Aquitard (D3)
	<input type="checkbox"/> FAC-Neutral Test (D5)

<b>Field Observations:</b>	
Surface Water Present? Yes _____ No <input checked="" type="checkbox"/>	Depth (inches): _____
Water Table Present? Yes _____ No <input checked="" type="checkbox"/>	Depth (inches): _____
Saturation Present? (includes capillary fringe) Yes _____ No <input checked="" type="checkbox"/>	Depth (inches): _____
<b>Wetland Hydrology Present?</b> Yes _____ No <input checked="" type="checkbox"/>	

Describe Recorded Data (stream gauge, monitoring well, aerial photos, previous inspections), if available:

Remarks:

**WETLAND DETERMINATION DATA FORM – Arid West Region**

Project/Site: Crow's Landing City/County: Stanislaus Sampling Date: 12/26/13  
 Applicant/Owner: Stanislaus County State: CA Sampling Point: 8  
 Investigator(s): T. Beyerl, P. Valle Section, Township, Range: \_\_\_\_\_  
 Landform (hillslope, terrace, etc.): terrace Local relief (concave, convex, none): concave Slope (%): 2  
 Subregion (LRR): LRRC Lat: \_\_\_\_\_ Long: \_\_\_\_\_ Datum: \_\_\_\_\_  
 Soil Map Unit Name: Capay clay, 0 to 2% slopes, rarely flooded NWI classification: \_\_\_\_\_  
 Are climatic / hydrologic conditions on the site typical for this time of year? Yes  No \_\_\_\_\_ (If no, explain in Remarks.)  
 Are Vegetation N, Soil N, or Hydrology N significantly disturbed? Are "Normal Circumstances" present? Yes  No \_\_\_\_\_  
 Are Vegetation N, Soil N, or Hydrology N naturally problematic? (If needed, explain any answers in Remarks.)

**SUMMARY OF FINDINGS – Attach site map showing sampling point locations, transects, important features, etc.**

Hydrophytic Vegetation Present? Yes _____ No <input checked="" type="checkbox"/> Hydric Soil Present? Yes _____ No <input checked="" type="checkbox"/> Wetland Hydrology Present? Yes _____ No <input checked="" type="checkbox"/>	Is the Sampled Area within a Wetland? Yes _____ No <input checked="" type="checkbox"/>
Remarks: <u>sample point is between Little Salado Creek bank/levee and Bell Road in a created swale.</u>	

**VEGETATION – Use scientific names of plants.**

Tree Stratum (Plot size: <u>25x50</u> )	Absolute % Cover	Dominant Species?	Indicator Status	Dominance Test worksheet:
1. <u>Elaeagnus angustifolia</u>	<u>60</u>	<u>Y</u>	<u>FAC</u>	Number of Dominant Species That Are OBL, FACW, or FAC: <u>1</u> (A)
2. _____	_____	_____	_____	Total Number of Dominant Species Across All Strata: <u>2</u> (B)
3. _____	_____	_____	_____	Percent of Dominant Species That Are OBL, FACW, or FAC: <u>50</u> (A/B)
4. _____	_____	_____	_____	<b>Prevalence Index worksheet:</b> Total % Cover of: _____ Multiply by: OBL species _____ x 1 = _____ FACW species _____ x 2 = _____ FAC species _____ x 3 = _____ FACU species _____ x 4 = _____ UPL species _____ x 5 = _____ Column Totals: _____ (A) _____ (B) Prevalence Index = B/A = _____
<u>60</u> = Total Cover				
Sapling/Shrub Stratum (Plot size: <u>25x50</u> )				
1. <u>Pyracantha angustifolia</u>	<u>25</u>	<u>NL</u>	_____	
2. _____	_____	_____	_____	<b>Hydrophytic Vegetation Indicators:</b> ___ Dominance Test is >50% ___ Prevalence Index is ≤3.0 <sup>1</sup> ___ Morphological Adaptations <sup>1</sup> (Provide supporting data in Remarks or on a separate sheet) ___ Problematic Hydrophytic Vegetation <sup>1</sup> (Explain)  <sup>1</sup> Indicators of hydric soil and wetland hydrology must be present, unless disturbed or problematic.
3. _____	_____	_____	_____	
4. _____	_____	_____	_____	
5. _____	_____	_____	_____	
<u>25</u> = Total Cover				
Herb Stratum (Plot size: _____)				
1. _____	_____	_____	_____	<b>Hydrophytic Vegetation Present?</b> Yes _____ No <input checked="" type="checkbox"/>
2. _____	_____	_____	_____	
3. _____	_____	_____	_____	
4. _____	_____	_____	_____	
_____ = Total Cover				
Woody Vine Stratum (Plot size: _____)				
1. _____	_____	_____	_____	% Bare Ground in Herb Stratum <u>100</u> % Cover of Biotic Crust _____
2. _____	_____	_____	_____	
_____ = Total Cover				
Remarks: <u>leaf litter and branches in herb layer</u>				

**SOIL**

Sampling Point: 8

Profile Description: (Describe to the depth needed to document the indicator or confirm the absence of indicators.)							
Depth (inches)	Matrix		Redox Features			Texture	Remarks
	Color (moist)	%	Color (moist)	%	Type <sup>1</sup>		
0-20	10YR 3/5	100				C	

<sup>1</sup>Type: C=Concentration, D=Depletion, RM=Reduced Matrix, CS=Covered or Coated Sand Grains. <sup>2</sup>Location: PL=Pore Lining, M=Matrix.

Hydric Soil Indicators: (Applicable to all LRRs, unless otherwise noted.)	Indicators for Problematic Hydric Soils <sup>3</sup> :
<input type="checkbox"/> Histosol (A1)	<input type="checkbox"/> 1 cm Muck (A9) (LRR C)
<input type="checkbox"/> Histic Epipedon (A2)	<input type="checkbox"/> 2 cm Muck (A10) (LRR B)
<input type="checkbox"/> Black Histic (A3)	<input type="checkbox"/> Reduced Vertic (F18)
<input type="checkbox"/> Hydrogen Sulfide (A4)	<input type="checkbox"/> Red Parent Material (TF2)
<input type="checkbox"/> Stratified Layers (A5) (LRR C)	<input type="checkbox"/> Other (Explain in Remarks)
<input type="checkbox"/> 1 cm Muck (A9) (LRR D)	
<input type="checkbox"/> Depleted Below Dark Surface (A11)	
<input type="checkbox"/> Thick Dark Surface (A12)	<sup>3</sup> Indicators of hydrophytic vegetation and wetland hydrology must be present, unless disturbed or problematic.
<input type="checkbox"/> Sandy Mucky Mineral (S1)	
<input type="checkbox"/> Sandy Gleyed Matrix (S4)	
<input type="checkbox"/> Sandy Redox (S5)	
<input type="checkbox"/> Stripped Matrix (S6)	
<input type="checkbox"/> Loamy Mucky Mineral (F1)	
<input type="checkbox"/> Loamy Gleyed Matrix (F2)	
<input type="checkbox"/> Depleted Matrix (F3)	
<input type="checkbox"/> Redox Dark Surface (F6)	
<input type="checkbox"/> Depleted Dark Surface (F7)	
<input type="checkbox"/> Redox Depressions (F8)	
<input type="checkbox"/> Vernal Pools (F9)	

**Restrictive Layer (if present):**  
 Type: \_\_\_\_\_  
 Depth (inches): \_\_\_\_\_

Hydric Soil Present? Yes \_\_\_\_\_ No

Remarks:

**HYDROLOGY**

Wetland Hydrology Indicators:		Secondary Indicators (2 or more required)
Primary Indicators (minimum of one required; check all that apply)		
<input type="checkbox"/> Surface Water (A1)	<input type="checkbox"/> Salt Crust (B11)	<input type="checkbox"/> Water Marks (B1) (Riverine)
<input type="checkbox"/> High Water Table (A2)	<input type="checkbox"/> Biotic Crust (B12)	<input type="checkbox"/> Sediment Deposits (B2) (Riverine)
<input type="checkbox"/> Saturation (A3)	<input type="checkbox"/> Aquatic Invertebrates (B13)	<input type="checkbox"/> Drift Deposits (B3) (Riverine)
<input type="checkbox"/> Water Marks (B1) (Nonriverine)	<input type="checkbox"/> Hydrogen Sulfide Odor (C1)	<input type="checkbox"/> Drainage Patterns (B10)
<input type="checkbox"/> Sediment Deposits (B2) (Nonriverine)	<input type="checkbox"/> Oxidized Rhizospheres along Living Roots (C3)	<input type="checkbox"/> Dry-Season Water Table (C2)
<input type="checkbox"/> Drift Deposits (B3) (Nonriverine)	<input type="checkbox"/> Presence of Reduced Iron (C4)	<input type="checkbox"/> Crayfish Burrows (C8)
<input type="checkbox"/> Surface Soil Cracks (B6)	<input type="checkbox"/> Recent Iron Reduction in Tilled Soils (C6)	<input type="checkbox"/> Saturation Visible on Aerial Imagery (C9)
<input type="checkbox"/> Inundation Visible on Aerial Imagery (B7)	<input type="checkbox"/> Thin Muck Surface (C7)	<input type="checkbox"/> Shallow Aquitard (D3)
<input type="checkbox"/> Water-Stained Leaves (B9)	<input type="checkbox"/> Other (Explain in Remarks)	<input type="checkbox"/> FAC-Neutral Test (D5)

**Field Observations:**  
 Surface Water Present? Yes \_\_\_\_\_ No  Depth (inches): \_\_\_\_\_  
 Water Table Present? Yes \_\_\_\_\_ No  Depth (inches): \_\_\_\_\_  
 Saturation Present? Yes \_\_\_\_\_ No  Depth (inches): \_\_\_\_\_  
 (includes capillary fringe)

Wetland Hydrology Present? Yes \_\_\_\_\_ No

Describe Recorded Data (stream gauge, monitoring well, aerial photos, previous inspections), if available:

Remarks:  
 No hydrology indicators but point is in low landscape position between canal berm and road bed of bell road.

**WETLAND DETERMINATION DATA FORM – Arid West Region**

Project/Site: Crow's Landing City/County: Stanislaus Sampling Date: 12/26/13  
 Applicant/Owner: Stanislaus County State: CA Sampling Point: 9  
 Investigator(s): T. Beyerl, P. Valle Section, Township, Range: \_\_\_\_\_  
 Landform (hillslope, terrace, etc.): terrace Local relief (concave, convex, none): none Slope (%): 2  
 Subregion (LRR): LRRC Lat: \_\_\_\_\_ Long: \_\_\_\_\_ Datum: \_\_\_\_\_  
 Soil Map Unit Name: Capay clay, 0 to 2% slopes, rarely flooded NWI classification: \_\_\_\_\_  
 Are climatic / hydrologic conditions on the site typical for this time of year? Yes  No \_\_\_\_\_ (If no, explain in Remarks.)  
 Are Vegetation N, Soil N, or Hydrology N significantly disturbed? Are "Normal Circumstances" present? Yes  No \_\_\_\_\_  
 Are Vegetation N, Soil N, or Hydrology N naturally problematic? (If needed, explain any answers in Remarks.)

**SUMMARY OF FINDINGS – Attach site map showing sampling point locations, transects, important features, etc.**

Hydrophytic Vegetation Present?	Yes _____ No <input checked="" type="checkbox"/>	Is the Sampled Area within a Wetland? Yes _____ No <input checked="" type="checkbox"/>
Hydric Soil Present?	Yes _____ No <input checked="" type="checkbox"/>	
Wetland Hydrology Present?	Yes _____ No <input checked="" type="checkbox"/>	
Remarks: <u>Upland point on bank of channelized creek (Little Salado creek)</u>		

**VEGETATION – Use scientific names of plants.**

Tree Stratum (Plot size: _____)	Absolute % Cover	Dominant Species?	Indicator Status	Dominance Test worksheet:
1. /				Number of Dominant Species That Are OBL, FACW, or FAC: <u>0</u> (A)
2. /				Total Number of Dominant Species Across All Strata: <u>2</u> (B)
3. /				Percent of Dominant Species That Are OBL, FACW, or FAC: <u>0</u> (A/B)
4. /				
= Total Cover				
Sapling/Shrub Stratum (Plot size: _____)				Prevalence Index worksheet:
1. /				Total % Cover of: _____ Multiply by: _____
2. /				OBL species _____ x 1 = _____
3. /				FACW species _____ x 2 = _____
4. /				FAC species _____ x 3 = _____
5. /				FACU species _____ x 4 = _____
				UPL species _____ x 5 = _____
= Total Cover				Column Totals: _____ (A) _____ (B)
				Prevalence Index = B/A = _____
Herb Stratum (Plot size: <u>20x20</u> )				Hydrophytic Vegetation Indicators:
1. <u>Brassica nigra</u>	<u>40</u>	<u>Y</u>	<u>NL</u>	___ Dominance Test is >50%
2. <u>Sorghum halepense</u>	<u>30</u>	<u>Y</u>	<u>FACU</u>	___ Prevalence Index is ≤3.0 <sup>1</sup>
3. <u>Silybum maritimum</u>	<u>5</u>	<u>N</u>	<u>NL</u>	___ Morphological Adaptations <sup>1</sup> (Provide supporting data in Remarks or on a separate sheet)
4. _____				___ Problematic Hydrophytic Vegetation <sup>1</sup> (Explain)
5. _____				
6. _____				
7. _____				
8. _____				
= Total Cover				
Woody Vine Stratum (Plot size: _____)				
1. /				
2. /				
= Total Cover				
% Bare Ground in Herb Stratum <u>25</u> % Cover of Biotic Crust _____				
Remarks: <u>Vegetation is maintained; in the process of burning weeds along the creek</u>				Hydrophytic Vegetation Present? Yes _____ No <input checked="" type="checkbox"/>

**SOIL**

Sampling Point: 9

**Profile Description: (Describe to the depth needed to document the indicator or confirm the absence of indicators.)**

Depth (inches)	Matrix		Redox Features				Texture	Remarks
	Color (moist)	%	Color (moist)	%	Type <sup>1</sup>	Loc <sup>2</sup>		
0-20	10YR 4/4	98	5YR 4/6	2	C	M	SCL	silty clay loam

<sup>1</sup>Type: C=Concentration, D=Depletion, RM=Reduced Matrix, CS=Covered or Coated Sand Grains.      <sup>2</sup>Location: PL=Pore Lining, M=Matrix.

<b>Hydric Soil Indicators: (Applicable to all LRRs, unless otherwise noted.)</b>		<b>Indicators for Problematic Hydric Soils<sup>3</sup>:</b>
<input type="checkbox"/> Histosol (A1)	<input type="checkbox"/> Sandy Redox (S5)	<input type="checkbox"/> 1 cm Muck (A9) (LRR C)
<input type="checkbox"/> Histic Epipedon (A2)	<input type="checkbox"/> Stripped Matrix (S6)	<input type="checkbox"/> 2 cm Muck (A10) (LRR B)
<input type="checkbox"/> Black Histic (A3)	<input type="checkbox"/> Loamy Mucky Mineral (F1)	<input type="checkbox"/> Reduced Vertic (F18)
<input type="checkbox"/> Hydrogen Sulfide (A4)	<input type="checkbox"/> Loamy Gleyed Matrix (F2)	<input type="checkbox"/> Red Parent Material (TF2)
<input type="checkbox"/> Stratified Layers (A5) (LRR C)	<input type="checkbox"/> Depleted Matrix (F3)	<input type="checkbox"/> Other (Explain in Remarks)
<input type="checkbox"/> 1 cm Muck (A9) (LRR D)	<input type="checkbox"/> Redox Dark Surface (F6)	
<input type="checkbox"/> Depleted Below Dark Surface (A11)	<input type="checkbox"/> Depleted Dark Surface (F7)	
<input type="checkbox"/> Thick Dark Surface (A12)	<input type="checkbox"/> Redox Depressions (F8)	
<input type="checkbox"/> Sandy Mucky Mineral (S1)	<input type="checkbox"/> Vernal Pools (F9)	
<input type="checkbox"/> Sandy Gleyed Matrix (S4)		

<sup>3</sup>Indicators of hydrophytic vegetation and wetland hydrology must be present, unless disturbed or problematic.

**Restrictive Layer (if present):**

Type: \_\_\_\_\_

Depth (inches): \_\_\_\_\_

Hydric Soil Present? Yes \_\_\_\_\_ No

Remarks: soil is in artificial creek berm and likely includes soil dredged from creek

**HYDROLOGY**

**Wetland Hydrology Indicators:**

Primary Indicators (minimum of one required; check all that apply)		Secondary Indicators (2 or more required)
<input type="checkbox"/> Surface Water (A1)	<input type="checkbox"/> Salt Crust (B11)	<input type="checkbox"/> Water Marks (B1) (Riverine)
<input type="checkbox"/> High Water Table (A2)	<input type="checkbox"/> Blotic Crust (B12)	<input type="checkbox"/> Sediment Deposits (B2) (Riverine)
<input type="checkbox"/> Saturation (A3)	<input type="checkbox"/> Aquatic Invertebrates (B13)	<input type="checkbox"/> Drift Deposits (B3) (Riverine)
<input type="checkbox"/> Water Marks (B1) (Nonriverine)	<input type="checkbox"/> Hydrogen Sulfide Odor (C1)	<input type="checkbox"/> Drainage Patterns (B10)
<input type="checkbox"/> Sediment Deposits (B2) (Nonriverine)	<input type="checkbox"/> Oxidized Rhizospheres along Living Roots (C3)	<input type="checkbox"/> Dry-Season Water Table (C2)
<input type="checkbox"/> Drift Deposits (B3) (Nonriverine)	<input type="checkbox"/> Presence of Reduced Iron (C4)	<input type="checkbox"/> Crayfish Burrows (C8)
<input type="checkbox"/> Surface Soil Cracks (B6)	<input type="checkbox"/> Recent Iron Reduction in Tilled Soils (C6)	<input type="checkbox"/> Saturation Visible on Aerial Imagery (C9)
<input type="checkbox"/> Inundation Visible on Aerial Imagery (B7)	<input type="checkbox"/> Thin Muck Surface (C7)	<input type="checkbox"/> Shallow Aquitard (D3)
<input type="checkbox"/> Water-Stained Leaves (B9)	<input type="checkbox"/> Other (Explain in Remarks)	<input type="checkbox"/> FAC-Neutral Test (D5)

**Field Observations:**

Surface Water Present? Yes \_\_\_\_\_ No  Depth (inches): \_\_\_\_\_

Water Table Present? Yes \_\_\_\_\_ No  Depth (inches): \_\_\_\_\_

Saturation Present? Yes \_\_\_\_\_ No  Depth (inches): \_\_\_\_\_ (includes capillary fringe)

Wetland Hydrology Present? Yes \_\_\_\_\_ No

Describe Recorded Data (stream gauge, monitoring well, aerial photos, previous inspections), if available:

Remarks: bank (berm) of channelized creek; mollusc shells found in soil pit

**WETLAND DETERMINATION DATA FORM – Arid West Region**

Project/Site: Crow's Landing City/County: Stanislaus Sampling Date: 12/26/13  
 Applicant/Owner: Stanislaus County State: CA Sampling Point: 10  
 Investigator(s): T. Beyerl, P. Valle Section, Township, Range: \_\_\_\_\_  
 Landform (hillslope, terrace, etc.): terrace Local relief (concave, convex, none): none Slope (%): 0  
 Subregion (LRR): LRRC Lat: \_\_\_\_\_ Long: \_\_\_\_\_ Datum: \_\_\_\_\_  
 Soil Map Unit Name: Capay clay, 0 to 2% slopes NWI classification: \_\_\_\_\_  
 Are climatic / hydrologic conditions on the site typical for this time of year? Yes  No \_\_\_\_\_ (If no, explain in Remarks.)  
 Are Vegetation N, Soil N, or Hydrology N significantly disturbed? Are "Normal Circumstances" present? Yes  No \_\_\_\_\_  
 Are Vegetation N, Soil N, or Hydrology N naturally problematic? (If needed, explain any answers in Remarks.)

**SUMMARY OF FINDINGS – Attach site map showing sampling point locations, transects, important features, etc.**

Hydrophytic Vegetation Present? Yes _____ No <input checked="" type="checkbox"/> Hydric Soil Present? Yes _____ No <input checked="" type="checkbox"/> Wetland Hydrology Present? Yes _____ No <input checked="" type="checkbox"/>	Is the Sampled Area within a Wetland? Yes _____ No <input checked="" type="checkbox"/>
Remarks: <u>Photos 4850-4854 Rmoff ditch running parallel to runways along perimeter of agricultural field conveys stormwater runoff &amp; agricultural tailwater.</u>	

**VEGETATION – Use scientific names of plants.**

Tree Stratum (Plot size: _____)	Absolute % Cover	Dominant Species?	Indicator Status	Dominance Test worksheet:
1. _____	_____	_____	_____	Number of Dominant Species That Are OBL, FACW, or FAC: <u>0</u> (A)  Total Number of Dominant Species Across All Strata: <u>3</u> (B)  Percent of Dominant Species That Are OBL, FACW, or FAC: <u>0</u> (A/B)
2. _____	_____	_____	_____	
3. _____	_____	_____	_____	
4. _____	_____	_____	_____	
= Total Cover				<b>Prevalence Index worksheet:</b> Total % Cover of: _____ Multiply by: _____ OBL species _____ x 1 = _____ FACW species _____ x 2 = _____ FAC species _____ x 3 = _____ FACU species _____ x 4 = _____ UPL species _____ x 5 = _____ Column Totals: _____ (A) _____ (B)  Prevalence Index = B/A = _____
= Total Cover				
= Total Cover				
1. <u>Sorghum halepense</u>	<u>40</u>	<u>Y</u>	<u>FACU</u>	
2. <u>Brassica nigra</u>	<u>15</u>	<u>Y</u>	<u>NL</u>	
3. <u>Salsola tragus</u>	<u>15</u>	<u>Y</u>	<u>FACU</u>	
4. <u>Erigeron bonariensis</u>	<u>10</u>	<u>N</u>	<u>FACU</u>	
5. <u>Bromus diandrus</u>	<u>5</u>	<u>N</u>	<u>NL</u>	
6. <u>Melilotus indicus</u>	<u>5</u>	<u>N</u>	<u>FACU</u>	
7. _____	_____	_____	_____	
8. _____	_____	_____	_____	
<u>90</u> = Total Cover				Hydrophytic Vegetation Indicators: ___ Dominance Test is >50% ___ Prevalence Index is ≤3.0 <sup>1</sup> ___ Morphological Adaptations <sup>1</sup> (Provide supporting data in Remarks or on a separate sheet) ___ Problematic Hydrophytic Vegetation <sup>1</sup> (Explain)
= Total Cover				
= Total Cover				<sup>1</sup> Indicators of hydric soil and wetland hydrology must be present, unless disturbed or problematic.
= Total Cover				
% Bare Ground in Herb Stratum <u>10</u> % Cover of Biotic Crust _____				Hydrophytic Vegetation Present? Yes _____ No <input checked="" type="checkbox"/>
Remarks: _____				

**SOIL**

Sampling Point: 10

**Profile Description: (Describe to the depth needed to document the indicator or confirm the absence of indicators.)**

Depth (inches)	Matrix		Redox Features				Texture	Remarks
	Color (moist)	%	Color (moist)	%	Type <sup>1</sup>	Loc <sup>2</sup>		

<sup>1</sup>Type: C=Concentration, D=Depletion, RM=Reduced Matrix, CS=Covered or Coated Sand Grains.      <sup>2</sup>Location: PL=Pore Lining, M=Matrix.

Hydric Soil Indicators: (Applicable to all LRRs, unless otherwise noted.)	Indicators for Problematic Hydric Soils <sup>3</sup> :
<input type="checkbox"/> Histosol (A1)	<input type="checkbox"/> Sandy Redox (S5)
<input type="checkbox"/> Histic Epipedon (A2)	<input type="checkbox"/> Stripped Matrix (S6)
<input type="checkbox"/> Black Histic (A3)	<input type="checkbox"/> Loamy Mucky Mineral (F1)
<input type="checkbox"/> Hydrogen Sulfide (A4)	<input type="checkbox"/> Loamy Gleyed Matrix (F2)
<input type="checkbox"/> Stratified Layers (A5) (LRR C)	<input type="checkbox"/> Depleted Matrix (F3)
<input type="checkbox"/> 1 cm Muck (A9) (LRR D)	<input type="checkbox"/> Redox Dark Surface (F6)
<input type="checkbox"/> Depleted Below Dark Surface (A11)	<input type="checkbox"/> Depleted Dark Surface (F7)
<input type="checkbox"/> Thick Dark Surface (A12)	<input type="checkbox"/> Redox Depressions (F8)
<input type="checkbox"/> Sandy Mucky Mineral (S1)	<input type="checkbox"/> Vernal Pools (F9)
<input type="checkbox"/> Sandy Gleyed Matrix (S4)	

<sup>3</sup>Indicators of hydrophytic vegetation and wetland hydrology must be present, unless disturbed or problematic.

**Restrictive Layer (if present):**  
 Type: \_\_\_\_\_  
 Depth (inches): \_\_\_\_\_

Hydric Soil Present? Yes \_\_\_\_\_ No

Remarks: *No soil pit excavated; point is within a runoff/return ditch that does not support hydrophytic vegetation.*

**HYDROLOGY**

**Wetland Hydrology Indicators:**

Primary Indicators (minimum of one required; check all that apply)	Secondary Indicators (2 or more required)
<input type="checkbox"/> Surface Water (A1)	<input type="checkbox"/> Salt Crust (B11)
<input type="checkbox"/> High Water Table (A2)	<input type="checkbox"/> Biotic Crust (B12)
<input type="checkbox"/> Saturation (A3)	<input type="checkbox"/> Aquatic Invertebrates (B13)
<input type="checkbox"/> Water Marks (B1) (Nonriverine)	<input type="checkbox"/> Hydrogen Sulfide Odor (C1)
<input type="checkbox"/> Sediment Deposits (B2) (Nonriverine)	<input type="checkbox"/> Oxidized Rhizospheres along Living Roots (C3)
<input type="checkbox"/> Drift Deposits (B3) (Nonriverine)	<input type="checkbox"/> Presence of Reduced Iron (C4)
<input type="checkbox"/> Surface Soil Cracks (B6)	<input type="checkbox"/> Recent Iron Reduction in Tilled Soils (C6)
<input type="checkbox"/> Inundation Visible on Aerial Imagery (B7)	<input type="checkbox"/> Thin Muck Surface (C7)
<input type="checkbox"/> Water-Stained Leaves (B9)	<input type="checkbox"/> Other (Explain in Remarks)
	<input type="checkbox"/> Water Marks (B1) (Riverine)
	<input type="checkbox"/> Sediment Deposits (B2) (Riverine)
	<input type="checkbox"/> Drift Deposits (B3) (Riverine)
	<input type="checkbox"/> Drainage Patterns (B10)
	<input type="checkbox"/> Dry-Season Water Table (C2)
	<input type="checkbox"/> Crayfish Burrows (C8)
	<input type="checkbox"/> Saturation Visible on Aerial Imagery (C9)
	<input type="checkbox"/> Shallow Aquitard (D3)
	<input type="checkbox"/> FAC-Neutral Test (D5)

**Field Observations:**

Surface Water Present? Yes _____ No <input checked="" type="checkbox"/>	Depth (inches): _____
Water Table Present? Yes _____ No <input checked="" type="checkbox"/>	Depth (inches): _____
Saturation Present? (includes capillary fringe) Yes _____ No <input checked="" type="checkbox"/>	Depth (inches): _____

Wetland Hydrology Present? Yes \_\_\_\_\_ No

Describe Recorded Data (stream gauge, monitoring well, aerial photos, previous inspections), if available:

Remarks: *Runoff ditch that conveys stormwater runoff and agricultural tailwater. 0Hwm = 6ft.*



**WETLAND DETERMINATION DATA FORM – Arid West Region**

Project/Site: Crow's Landing City/County: Stanislaus Sampling Date: 10/26/13  
 Applicant/Owner: Stanislaus County State: CA Sampling Point: 11  
 Investigator(s): T. Beyerl, P. Valle Section, Township, Range: \_\_\_\_\_  
 Landform (hillslope, terrace, etc.): terrace Local relief (concave, convex, none): none Slope (%): 1  
 Subregion (LRR): LRRC Lat: \_\_\_\_\_ Long: \_\_\_\_\_ Datum: \_\_\_\_\_  
 Soil Map Unit Name: Capay clay, 0 to 2% slopes, rarely flooded NWI classification: \_\_\_\_\_  
 Are climatic / hydrologic conditions on the site typical for this time of year? Yes  No \_\_\_\_\_ (If no, explain in Remarks.)  
 Are Vegetation N, Soil N, or Hydrology N significantly disturbed? Are "Normal Circumstances" present? Yes  No \_\_\_\_\_  
 Are Vegetation N, Soil N, or Hydrology N naturally problematic? (If needed, explain any answers in Remarks.)

**SUMMARY OF FINDINGS – Attach site map showing sampling point locations, transects, important features, etc.**

Hydrophytic Vegetation Present? Yes _____ No <input checked="" type="checkbox"/> Hydric Soil Present? Yes _____ No <input checked="" type="checkbox"/> Wetland Hydrology Present? Yes _____ No <input checked="" type="checkbox"/>	Is the Sampled Area within a Wetland? Yes _____ No <input checked="" type="checkbox"/>
Remarks: <u>Photos 4855-4857 Runoff ditch running parallel to paved road leading from support facilities to runway.</u>	

**VEGETATION – Use scientific names of plants.**

Tree Stratum (Plot size: _____)	Absolute % Cover	Dominant Species?	Indicator Status	Dominance Test worksheet:
1. _____	_____	_____	_____	Number of Dominant Species That Are OBL, FACW, or FAC: <u>0</u> (A)
2. _____	_____	_____	_____	Total Number of Dominant Species Across All Strata: <u>3</u> (B)
3. _____	_____	_____	_____	Percent of Dominant Species That Are OBL, FACW, or FAC: <u>0</u> (A/B)
4. _____	_____	_____	_____	
_____ = Total Cover				
Sapling/Shrub Stratum (Plot size: _____)				Prevalence Index worksheet: Total % Cover of: _____ Multiply by: _____ OBL species _____ x 1 = _____ FACW species _____ x 2 = _____ FAC species _____ x 3 = _____ FACU species _____ x 4 = _____ UPL species _____ x 5 = _____ Column Totals: _____ (A) _____ (B) Prevalence Index = B/A = _____
Herb Stratum (Plot size: _____)				Hydrophytic Vegetation Indicators: ___ Dominance Test is >50% ___ Prevalence Index is ≤3.0 <sup>1</sup> ___ Morphological Adaptations <sup>1</sup> (Provide supporting data in Remarks or on a separate sheet) ___ Problematic Hydrophytic Vegetation <sup>1</sup> (Explain)
1. <u>Centaurea solstitialis</u>	<u>35</u>	<u>Y</u>	<u>NL</u>	<sup>1</sup> Indicators of hydric soil and wetland hydrology must be present, unless disturbed or problematic.  Hydrophytic Vegetation Present? Yes _____ No <input checked="" type="checkbox"/>
2. <u>Helminthotheca echioides</u>	<u>25</u>	<u>Y</u>	<u>FACU</u>	
3. <u>Sorghum halepense</u>	<u>20</u>	<u>Y</u>	<u>FACU</u>	
4. <u>Brassica nigra</u>	<u>15</u>	<u>N</u>	<u>NL</u>	
5. _____	_____	_____	_____	
6. _____	_____	_____	_____	
7. _____	_____	_____	_____	
8. _____	_____	_____	_____	
<u>95</u> = Total Cover				
Woody Vine Stratum (Plot size: _____)				
1. _____	_____	_____	_____	
2. _____	_____	_____	_____	
_____ = Total Cover				
% Bare Ground in Herb Stratum <u>5</u>		% Cover of Biotic Crust _____		
Remarks:				

**SOIL**

Sampling Point: 11

**Profile Description: (Describe to the depth needed to document the indicator or confirm the absence of indicators.)**

Depth (inches)	Matrix		Redox Features				Texture	Remarks
	Color (moist)	%	Color (moist)	%	Type <sup>1</sup>	Loc <sup>2</sup>		

<sup>1</sup>Type: C=Concentration, D=Depletion, RM=Reduced Matrix, CS=Covered or Coated Sand Grains.      <sup>2</sup>Location: PL=Pore Lining, M=Matrix.

<b>Hydric Soil Indicators: (Applicable to all LRRs, unless otherwise noted.)</b>	<b>Indicators for Problematic Hydric Soils<sup>3</sup>:</b>
<input type="checkbox"/> Histosol (A1) <input type="checkbox"/> Histic Epipedon (A2) <input type="checkbox"/> Black Histic (A3) <input type="checkbox"/> Hydrogen Sulfide (A4) <input type="checkbox"/> Stratified Layers (A5) (LRR C) <input type="checkbox"/> 1 cm Muck (A9) (LRR D) <input type="checkbox"/> Depleted Below Dark Surface (A11) <input type="checkbox"/> Thick Dark Surface (A12) <input type="checkbox"/> Sandy Mucky Mineral (S1) <input type="checkbox"/> Sandy Gleyed Matrix (S4)	<input type="checkbox"/> Sandy Redox (S5) <input type="checkbox"/> Stripped Matrix (S6) <input type="checkbox"/> Loamy Mucky Mineral (F1) <input type="checkbox"/> Loamy Gleyed Matrix (F2) <input type="checkbox"/> Depleted Matrix (F3) <input type="checkbox"/> Redox Dark Surface (F6) <input type="checkbox"/> Depleted Dark Surface (F7) <input type="checkbox"/> Redox Depressions (F8) <input type="checkbox"/> Vernal Pools (F9)
	<input type="checkbox"/> 1 cm Muck (A9) (LRR C) <input type="checkbox"/> 2 cm Muck (A10) (LRR B) <input type="checkbox"/> Reduced Vertic (F18) <input type="checkbox"/> Red Parent Material (TF2) <input type="checkbox"/> Other (Explain in Remarks)

<sup>3</sup>Indicators of hydrophytic vegetation and wetland hydrology must be present, unless disturbed or problematic.

**Restrictive Layer (if present):**  
 Type: \_\_\_\_\_  
 Depth (Inches): \_\_\_\_\_

Hydric Soil Present? Yes \_\_\_\_\_ No

Remarks: *No soil pit excavated, point is within 0.1m of a runoff conveyance ditch that does not support hydrophytic vegetation.*

**HYDROLOGY**

<b>Wetland Hydrology Indicators:</b>	
<b>Primary Indicators (minimum of one required; check all that apply)</b>	<b>Secondary Indicators (2 or more required)</b>
<input type="checkbox"/> Surface Water (A1) <input type="checkbox"/> High Water Table (A2) <input type="checkbox"/> Saturation (A3) <input type="checkbox"/> Water Marks (B1) (Nonriverine) <input type="checkbox"/> Sediment Deposits (B2) (Nonriverine) <input type="checkbox"/> Drift Deposits (B3) (Nonriverine) <input type="checkbox"/> Surface Soil Cracks (B6) <input type="checkbox"/> Inundation Visible on Aerial Imagery (B7) <input type="checkbox"/> Water-Stained Leaves (B9)	<input type="checkbox"/> Salt Crust (B11) <input type="checkbox"/> Biotic Crust (B12) <input type="checkbox"/> Aquatic Invertebrates (B13) <input type="checkbox"/> Hydrogen Sulfide Odor (C1) <input type="checkbox"/> Oxidized Rhizospheres along Living Roots (C3) <input type="checkbox"/> Presence of Reduced Iron (C4) <input type="checkbox"/> Recent Iron Reduction in Tilled Soils (C6) <input type="checkbox"/> Thin Muck Surface (C7) <input type="checkbox"/> Other (Explain in Remarks)
	<input type="checkbox"/> Water Marks (B1) (Riverine) <input type="checkbox"/> Sediment Deposits (B2) (Riverine) <input type="checkbox"/> Drift Deposits (B3) (Riverine) <input type="checkbox"/> Drainage Patterns (B10) <input type="checkbox"/> Dry-Season Water Table (C2) <input type="checkbox"/> Crayfish Burrows (C8) <input type="checkbox"/> Saturation Visible on Aerial Imagery (C9) <input type="checkbox"/> Shallow Aquitard (D3) <input type="checkbox"/> FAC-Neutral Test (D5)

**Field Observations:**

Surface Water Present? Yes \_\_\_\_\_ No  Depth (Inches): \_\_\_\_\_

Water Table Present? Yes \_\_\_\_\_ No  Depth (Inches): \_\_\_\_\_

Saturation Present? (includes capillary fringe) Yes \_\_\_\_\_ No  Depth (Inches): \_\_\_\_\_

Wetland Hydrology Present? Yes \_\_\_\_\_ No

Describe Recorded Data (stream gauge, monitoring well, aerial photos, previous inspections), if available:

Remarks: *Runoff ditch that conveys storm water runoff from roads and facilities; constructed in uplands, width of 0.1m = 2ft.*

**WETLAND DETERMINATION DATA FORM – Arid West Region**

Project/Site: Crow's Landing City/County: Stanislaus Sampling Date: 10/18/16  
 Applicant/Owner: Stanislaus County State: CA Sampling Point: 12  
 Investigator(s): C. Battaglia Section, Township, Range: \_\_\_\_\_  
 Landform (hillslope, terrace, etc.): terrace Local relief (concave, convex, none): None Slope (%): 0  
 Subregion (LRR): LRRC Lat: 37°24'21.89" N Long: 121°4'52.25" W Datum: NAD83  
 Soil Map Unit Name: Capay clay, wet 0-2% slopes NWI classification: None  
 Are climatic / hydrologic conditions on the site typical for this time of year? Yes  No \_\_\_\_\_ (If no, explain in Remarks.)  
 Are Vegetation N, Soil N, or Hydrology N significantly disturbed? Are "Normal Circumstances" present? Yes  No \_\_\_\_\_  
 Are Vegetation N, Soil N, or Hydrology N naturally problematic? (If needed, explain any answers in Remarks.)

**SUMMARY OF FINDINGS – Attach site map showing sampling point locations, transects, important features, etc.**

Hydrophytic Vegetation Present? Yes <input checked="" type="checkbox"/> No _____ Hydric Soil Present? Yes <input checked="" type="checkbox"/> No _____ Wetland Hydrology Present? Yes <input checked="" type="checkbox"/> No _____	Is the Sampled Area within a Wetland? Yes <input checked="" type="checkbox"/> No _____
Remarks: <u>Small basin used to pump/fill with water; part of crop irrigation system (like Crow Rd - Hwy 33). Basin current dry so upland veg is colonizing.</u>	

**VEGETATION – Use scientific names of plants.**

Tree Stratum (Plot size: _____)	Absolute % Cover	Dominant Species?	Indicator Status	Dominance Test worksheet:
1. _____	_____	_____	_____	Number of Dominant Species That Are OBL, FACW, or FAC: <u>2</u> (A)
2. _____	_____	_____	_____	Total Number of Dominant Species Across All Strata: <u>3</u> (B)
3. _____	_____	_____	_____	Percent of Dominant Species That Are OBL, FACW, or FAC: <u>66</u> (A/B)
4. _____	_____	_____	_____	
_____ = Total Cover				
Sapling/Shrub Stratum (Plot size: _____)	Absolute % Cover	Dominant Species?	Indicator Status	Prevalence Index worksheet:
1. _____	_____	_____	_____	Total % Cover of: _____ Multiply by: _____
2. _____	_____	_____	_____	OBL species _____ x 1 = _____
3. _____	_____	_____	_____	FACW species _____ x 2 = _____
4. _____	_____	_____	_____	FAC species _____ x 3 = _____
5. _____	_____	_____	_____	FACU species _____ x 4 = _____
_____ = Total Cover				UPL species _____ x 5 = _____
				Column Totals: _____ (A) _____ (B)
				Prevalence Index = B/A = _____
Herb Stratum (Plot size: _____)	Absolute % Cover	Dominant Species?	Indicator Status	Hydrophytic Vegetation Indicators:
1. <u>Echinochloa crus-galli</u>	<u>35</u>	<u>Y</u>	<u>FACW</u>	<input checked="" type="checkbox"/> Dominance Test is >50%
2. <u>Typha latifolia</u>	<u>20</u>	<u>Y</u>	<u>OBL</u>	<input type="checkbox"/> Prevalence Index is ≤3.0 <sup>1</sup>
3. <u>Convolvulus arvensis</u>	<u>20</u>	<u>Y</u>	<u>NL</u>	<input type="checkbox"/> Morphological Adaptations <sup>1</sup> (Provide supporting data in Remarks or on a separate sheet)
4. <u>Erigeron bonariensis</u>	<u>10</u>	<u>N</u>	<u>FACU</u>	<input type="checkbox"/> Problematic Hydrophytic Vegetation <sup>1</sup> (Explain)
5. <u>Cyperus eragrostis</u>	<u>5</u>	<u>N</u>	<u>FACW</u>	
6. <u>Amaranthus albus</u>	<u>5</u>	<u>N</u>	<u>FACU</u>	
7. <u>Leptochloa fascicularis</u>	<u>5</u>	<u>N</u>	<u>NL</u>	
8. <u>Malva neglecta</u>	<u>&lt;1</u>	<u>N</u>	<u>NL</u>	
<u>100</u> = Total Cover				
				<sup>1</sup> Indicators of hydric soil and wetland hydrology must be present, unless disturbed or problematic.
Woody Vine Stratum (Plot size: _____)	Absolute % Cover	Dominant Species?	Indicator Status	Hydrophytic Vegetation Present?
1. _____	_____	_____	_____	Yes <input checked="" type="checkbox"/> No _____
2. _____	_____	_____	_____	
_____ = Total Cover				
% Bare Ground in Herb Stratum <u>10</u> % Cover of Biotic Crust _____				
Remarks: _____				

**SOIL**

Sampling Point: 12

Profile Description: (Describe to the depth needed to document the indicator or confirm the absence of indicators.)

Depth (inches)	Matrix		Redox Features				Texture	Remarks
	Color (moist)	%	Color (moist)	%	Type <sup>1</sup>	Loc <sup>2</sup>		

<sup>1</sup>Type: C=Concentration, D=Depletion, RM=Reduced Matrix, CS=Covered or Coated Sand Grains. <sup>2</sup>Location: PL=Pore Lining, M=Matrix.

Hydric Soil Indicators: (Applicable to all LRRs, unless otherwise noted.)	Indicators for Problematic Hydric Soils <sup>3</sup> :
<input type="checkbox"/> Histosol (A1) <input type="checkbox"/> Histic Epipedon (A2) <input type="checkbox"/> Black Histic (A3) <input type="checkbox"/> Hydrogen Sulfide (A4) <input type="checkbox"/> Stratified Layers (A5) (LRR C) <input type="checkbox"/> 1 cm Muck (A9) (LRR D) <input type="checkbox"/> Depleted Below Dark Surface (A11) <input type="checkbox"/> Thick Dark Surface (A12) <input type="checkbox"/> Sandy Mucky Mineral (S1) <input type="checkbox"/> Sandy Gleyed Matrix (S4)	<input type="checkbox"/> Sandy Redox (S5) <input type="checkbox"/> Stripped Matrix (S6) <input type="checkbox"/> Loamy Mucky Mineral (F1) <input type="checkbox"/> Loamy Gleyed Matrix (F2) <input type="checkbox"/> Depleted Matrix (F3) <input type="checkbox"/> Redox Dark Surface (F6) <input type="checkbox"/> Depleted Dark Surface (F7) <input type="checkbox"/> Redox Depressions (F8) <input type="checkbox"/> Vernal Pools (F9)
<input type="checkbox"/> 1 cm Muck (A9) (LRR C) <input type="checkbox"/> 2 cm Muck (A10) (LRR B) <input type="checkbox"/> Reduced Vertic (F18) <input type="checkbox"/> Red Parent Material (TF2) <input type="checkbox"/> Other (Explain in Remarks)	<sup>3</sup> Indicators of hydrophytic vegetation and wetland hydrology must be present, unless disturbed or problematic.

**Restrictive Layer (if present):**  
 Type: \_\_\_\_\_  
 Depth (inches): \_\_\_\_\_  
 Hydric Soil Present? Yes \_\_\_\_\_ No \_\_\_\_\_

Remarks: NO soil pit taken

**HYDROLOGY**

Wetland Hydrology Indicators:	Secondary Indicators (2 or more required)
<b>Primary Indicators (minimum of one required; check all that apply)</b> <input type="checkbox"/> Surface Water (A1) <input type="checkbox"/> High Water Table (A2) <input type="checkbox"/> Saturation (A3) <input type="checkbox"/> Water Marks (B1) (Nonriverine) <input type="checkbox"/> Sediment Deposits (B2) (Nonriverine) <input type="checkbox"/> Drift Deposits (B3) (Nonriverine) <input checked="" type="checkbox"/> Surface Soil Cracks (B6) <input checked="" type="checkbox"/> Inundation Visible on Aerial Imagery (B7) <input type="checkbox"/> Water-Stained Leaves (B9)	<input type="checkbox"/> Salt Crust (B11) <input type="checkbox"/> Biotic Crust (B12) <input type="checkbox"/> Aquatic Invertebrates (B13) <input type="checkbox"/> Hydrogen Sulfide Odor (C1) <input type="checkbox"/> Oxidized Rhizospheres along Living Roots (C3) <input type="checkbox"/> Presence of Reduced Iron (C4) <input type="checkbox"/> Recent Iron Reduction in Tilled Soils (C6) <input type="checkbox"/> Thin Muck Surface (C7) <input type="checkbox"/> Other (Explain in Remarks)
<input type="checkbox"/> Water Marks (B1) (Riverine) <input type="checkbox"/> Sediment Deposits (B2) (Riverine) <input type="checkbox"/> Drift Deposits (B3) (Riverine) <input type="checkbox"/> Drainage Patterns (B10) <input type="checkbox"/> Dry-Season Water Table (C2) <input type="checkbox"/> Crayfish Burrows (C8) <input type="checkbox"/> Saturation Visible on Aerial Imagery (C9) <input type="checkbox"/> Shallow Aquitard (D3) <input type="checkbox"/> FAC-Neutral Test (D5)	

**Field Observations:**  
 Surface Water Present? Yes \_\_\_\_\_ No  Depth (inches): \_\_\_\_\_  
 Water Table Present? Yes \_\_\_\_\_ No  Depth (inches): \_\_\_\_\_  
 Saturation Present? Yes \_\_\_\_\_ No  Depth (inches): \_\_\_\_\_  
 (includes capillary fringe)  
 Wetland Hydrology Present? Yes  No \_\_\_\_\_

Describe Recorded Data (stream gauge, monitoring well, aerial photos, previous inspections), if available:

Remarks: man-made, created, irrigation basin; flow controlled by pumps and culvert and control gate that moves water to larger ditch to south, across Ike Crow Rd, which is also partially within project boundary.

(OTWMM = 23 feet)

**WETLAND DETERMINATION DATA FORM – Arid West Region**

Project/Site: Crows Landing City/County: Stanislaus Sampling Date: 10/18/16  
 Applicant/Owner: Stanislaus County State: CA Sampling Point: 13  
 Investigator(s): C. Battaglia Section, Township, Range: \_\_\_\_\_  
 Landform (hillslope, terrace, etc.): terrace Local relief (concave, convex, none): None Slope (%): 0  
 Subregion (LRR): LRR C Lat: 37°26'7.02"N Long: 121°6'8.13"W Datum: NAD83  
 Soil Map Unit Name: Zacharias clay loam, 0-2% slopes NWI classification: None - ditch on south side of rd is PUBEX but outside PA  
 Are climatic / hydrologic conditions on the site typical for this time of year? Yes  No \_\_\_\_\_ (If no, explain in Remarks.)  
 Are Vegetation N, Soil N, or Hydrology N significantly disturbed? Are "Normal Circumstances" present? Yes  No \_\_\_\_\_  
 Are Vegetation N, Soil N, or Hydrology N naturally problematic? (If needed, explain any answers in Remarks.)

**SUMMARY OF FINDINGS – Attach site map showing sampling point locations, transects, important features, etc.**

Hydrophytic Vegetation Present? Yes _____ No <input checked="" type="checkbox"/>	Is the Sampled Area within a Wetland? Yes <input checked="" type="checkbox"/> No _____
Hydric Soil Present? Yes _____ No <input checked="" type="checkbox"/>	
Wetland Hydrology Present? Yes <input checked="" type="checkbox"/> No _____	

Remarks: Small basin NW corner of Marshall Rd & Hwy 33; used to hold/distribute irrigation water to field crops, part of irrigation ditch

**VEGETATION – Use scientific names of plants.**

Tree Stratum (Plot size: _____)	Absolute % Cover	Dominant Species?	Indicator Status	Dominance Test worksheet:
1. _____				Number of Dominant Species That Are OBL, FACW, or FAC: <u>1</u> (A)
2. _____				Total Number of Dominant Species Across All Strata: <u>2</u> (B)
3. _____				Percent of Dominant Species That Are OBL, FACW, or FAC: <u>50</u> (A/B)
4. _____				
_____ = Total Cover				
Sapling/Shrub Stratum (Plot size: _____)				<b>Prevalence Index worksheet:</b>
1. _____				Total % Cover of: _____ Multiply by: _____
2. _____				OBL species _____ x 1 = _____
3. _____				FACW species _____ x 2 = _____
4. _____				FAC species _____ x 3 = _____
5. _____				FACU species _____ x 4 = _____
_____ = Total Cover				UPL species _____ x 5 = _____
				Column Totals: _____ (A) _____ (B)
				Prevalence Index = B/A = _____
Herb Stratum (Plot size: _____)				<b>Hydrophytic Vegetation Indicators:</b>
1. <u>Echinochloa crus-galli</u>	<u>30</u>	<u>Y</u>	<u>FAC</u>	<input type="checkbox"/> Dominance Test is >50%
2. <u>Amaranthus albus</u>	<u>20</u>	<u>Y</u>	<u>FACU</u>	<input type="checkbox"/> Prevalence Index is ≤3.0 <sup>1</sup>
3. <u>Cyperus eragrostis</u>	<u>5</u>	<u>N</u>	<u>FACW</u>	<input type="checkbox"/> Morphological Adaptations <sup>1</sup> (Provide supporting data in Remarks or on a separate sheet)
4. <u>Rumex crispus</u>	<u>5</u>	<u>N</u>	<u>FAC</u>	<input type="checkbox"/> Problematic Hydrophytic Vegetation <sup>1</sup> (Explain)
5. _____				
6. _____				
7. _____				
8. _____				
<u>60</u> = Total Cover <u>30/12</u>				
Woody Vine Stratum (Plot size: _____)				<sup>1</sup> Indicators of hydric soil and wetland hydrology must be present, unless disturbed or problematic.
1. _____				
2. _____				
_____ = Total Cover				
% Bare Ground in Herb Stratum <u>50</u>		% Cover of Biotic Crust _____		<b>Hydrophytic Vegetation Present?</b> Yes _____ No <input checked="" type="checkbox"/>

Remarks: \_\_\_\_\_

**SOIL**

Sampling Point: \_\_\_\_\_

Profile Description: (Describe to the depth needed to document the indicator or confirm the absence of indicators.)

Depth (inches)	Matrix		Redox Features				Texture	Remarks
	Color (moist)	%	Color (moist)	%	Type <sup>1</sup>	Loc <sup>2</sup>		

<sup>1</sup>Type: C=Concentration, D=Depletion, RM=Reduced Matrix, CS=Covered or Coated Sand Grains. <sup>2</sup>Location: PL=Pore Lining, M=Matrix.

<b>Hydric Soil Indicators:</b> (Applicable to all LRRs, unless otherwise noted.) <input type="checkbox"/> Histosol (A1) <input type="checkbox"/> Histic Epipedon (A2) <input type="checkbox"/> Black Histic (A3) <input type="checkbox"/> Hydrogen Sulfide (A4) <input type="checkbox"/> Stratified Layers (A5) (LRR C) <input type="checkbox"/> 1 cm Muck (A9) (LRR D) <input type="checkbox"/> Depleted Below Dark Surface (A11) <input type="checkbox"/> Thick Dark Surface (A12) <input type="checkbox"/> Sandy Mucky Mineral (S1) <input type="checkbox"/> Sandy Gleyed Matrix (S4)	<input type="checkbox"/> Sandy Redox (S5) <input type="checkbox"/> Stripped Matrix (S6) <input type="checkbox"/> Loamy Mucky Mineral (F1) <input type="checkbox"/> Loamy Gleyed Matrix (F2) <input type="checkbox"/> Depleted Matrix (F3) <input type="checkbox"/> Redox Dark Surface (F6) <input type="checkbox"/> Depleted Dark Surface (F7) <input type="checkbox"/> Redox Depressions (F8) <input type="checkbox"/> Vernal Pools (F9)	<b>Indicators for Problematic Hydric Soils<sup>3</sup>:</b> <input type="checkbox"/> 1 cm Muck (A9) (LRR C) <input type="checkbox"/> 2 cm Muck (A10) (LRR B) <input type="checkbox"/> Reduced Vertic (F18) <input type="checkbox"/> Red Parent Material (TF2) <input type="checkbox"/> Other (Explain in Remarks)  <sup>3</sup> Indicators of hydrophytic vegetation and wetland hydrology must be present, unless disturbed or problematic.
--	---	---

<b>Restrictive Layer (if present):</b> Type: _____ Depth (inches): _____	<b>Hydric Soil Present?</b> Yes _____ No _____
--	--

Remarks: *no soil pit taken, as ag/irrigation basin is clearly defined*

**HYDROLOGY**

<b>Wetland Hydrology Indicators:</b>		
<b>Primary Indicators (minimum of one required; check all that apply)</b>		<b>Secondary Indicators (2 or more required)</b>
<input type="checkbox"/> Surface Water (A1) <input type="checkbox"/> High Water Table (A2) <input type="checkbox"/> Saturation (A3) <input type="checkbox"/> Water Marks (B1) (Nonriverine) <input type="checkbox"/> Sediment Deposits (B2) (Nonriverine) <input type="checkbox"/> Drift Deposits (B3) (Nonriverine) <input checked="" type="checkbox"/> Surface Soil Cracks (B6) <input checked="" type="checkbox"/> Inundation Visible on Aerial Imagery (B7) <input type="checkbox"/> Water-Stained Leaves (B9)	<input type="checkbox"/> Salt Crust (B11) <input type="checkbox"/> Biotic Crust (B12) <input type="checkbox"/> Aquatic Invertebrates (B13) <input type="checkbox"/> Hydrogen Sulfide Odor (C1) <input type="checkbox"/> Oxidized Rhizospheres along Living Roots (C3) <input type="checkbox"/> Presence of Reduced Iron (C4) <input type="checkbox"/> Recent Iron Reduction in Tilled Soils (C6) <input type="checkbox"/> Thin Muck Surface (C7) <input type="checkbox"/> Other (Explain in Remarks)	<input type="checkbox"/> Water Marks (B1) (Riverine) <input type="checkbox"/> Sediment Deposits (B2) (Riverine) <input type="checkbox"/> Drift Deposits (B3) (Riverine) <input type="checkbox"/> Drainage Patterns (B10) <input type="checkbox"/> Dry-Season Water Table (C2) <input type="checkbox"/> Crayfish Burrows (C8) <input type="checkbox"/> Saturation Visible on Aerial Imagery (C9) <input type="checkbox"/> Shallow Aquitard (D3) <input type="checkbox"/> FAC-Neutral Test (D5)

<b>Field Observations:</b>		
Surface Water Present? Yes _____ No <input checked="" type="checkbox"/> Water Table Present? Yes _____ No <input checked="" type="checkbox"/> Saturation Present? Yes _____ No <input checked="" type="checkbox"/> (includes capillary fringe)	Depth (inches): _____ Depth (inches): _____ Depth (inches): _____	<b>Wetland Hydrology Present?</b> Yes <input checked="" type="checkbox"/> No _____

Describe Recorded Data (stream gauge, monitoring well, aerial photos, previous inspections), if available:

Remarks: *man. made created irrigation basin; flow controlled by pumps and control gate that moves water to larger ditch to south, across marshall rd, which is outside project boundary. Deep soil cracks present. (OHWM = 20 feet)*

**WETLAND DETERMINATION DATA FORM – Arid West Region**

Project/Site: Crow's Landing City/County: Stanislaus Sampling Date: 10/18/16  
 Applicant/Owner: Stanislaus county State: CA Sampling Point: 14  
 Investigator(s): C. Battaglia Section, Township, Range: \_\_\_\_\_  
 Landform (hillslope, terrace, etc.): terrace Local relief (concave, convex, none): none Slope (%): 0  
 Subregion (LRR): LERC Lat: 37°26'7.82"N Long: 121°8'2.08"W Datum: NAD83  
 Soil Map Unit Name: ElSalado 10am, 0-2% slopes NWI classification: None

Are climatic / hydrologic conditions on the site typical for this time of year? Yes  No \_\_\_\_\_ (If no, explain in Remarks.)  
 Are Vegetation N, Soil N, or Hydrology N significantly disturbed? Are "Normal Circumstances" present? Yes  No \_\_\_\_\_  
 Are Vegetation N, Soil N, or Hydrology N naturally problematic? (If needed, explain any answers in Remarks.)

**SUMMARY OF FINDINGS – Attach site map showing sampling point locations, transects, important features, etc.**

Hydrophytic Vegetation Present? Yes <input checked="" type="checkbox"/> No _____ Hydric Soil Present? Yes _____ No _____ Wetland Hydrology Present? Yes <input checked="" type="checkbox"/> No _____	Is the Sampled Area within a Wetland? Yes _____ No _____
Remarks: <u>Irrigation canal used to distribute water to field crops (Marshall Rd, east of Ward Ave), parallel to Delta-Mendota Canal.</u>	

**VEGETATION – Use scientific names of plants.**

Tree Stratum (Plot size: _____)	Absolute % Cover	Dominant Species?	Indicator Status	Dominance Test worksheet:
1. _____	_____	_____	_____	Number of Dominant Species That Are OBL, FACW, or FAC: <u>1</u> (A)
2. _____	_____	_____	_____	Total Number of Dominant Species Across All Strata: <u>1</u> (B)
3. _____	_____	_____	_____	Percent of Dominant Species That Are OBL, FACW, or FAC: <u>100</u> (A/B)
4. _____	_____	_____	_____	
= Total Cover				
Sapling/Shrub Stratum (Plot size: _____)				<b>Prevalence Index worksheet:</b>
1. <u>Salix goodingii</u>	<u>2</u>	<u>N</u>	<u>FACW</u>	Total % Cover of: _____ Multiply by: _____
2. _____	_____	_____	_____	OBL species _____ x 1 = _____
3. _____	_____	_____	_____	FACW species _____ x 2 = _____
4. _____	_____	_____	_____	FAC species _____ x 3 = _____
5. _____	_____	_____	_____	FACU species _____ x 4 = _____
= Total Cover				UPL species _____ x 5 = _____
				Column Totals: _____ (A) _____ (B)
				Prevalence Index = B/A = _____
Herb Stratum (Plot size: _____)				<b>Hydrophytic Vegetation Indicators:</b>
1. <u>Echinochloa crus-galli</u>	<u>60</u>	<u>Y</u>	<u>FAC</u>	<input checked="" type="checkbox"/> Dominance Test is >50%
2. <u>Xanthium strumarium</u>	<u>10</u>	<u>N</u>	<u>FAC</u>	<input type="checkbox"/> Prevalence Index is ≤3.0 <sup>1</sup>
3. <u>Amaranthus albus</u>	<u>5</u>	<u>N</u>	<u>FACU</u>	<input type="checkbox"/> Morphological Adaptations <sup>1</sup> (Provide supporting data in Remarks or on a separate sheet)
4. <u>Cyperus eragrostis</u>	<u>5</u>	<u>N</u>	<u>FACW</u>	<input type="checkbox"/> Problematic Hydrophytic Vegetation <sup>1</sup> (Explain)
5. _____	_____	_____	_____	
6. _____	_____	_____	_____	
7. _____	_____	_____	_____	
8. _____	_____	_____	_____	
<u>80</u> = Total Cover				<sup>1</sup> Indicators of hydric soil and wetland hydrology must be present, unless disturbed or problematic.
<u>40/16</u>				
Woody Vine Stratum (Plot size: _____)				<b>Hydrophytic Vegetation Present?</b> Yes <input checked="" type="checkbox"/> No _____
1. _____	_____	_____	_____	
2. _____	_____	_____	_____	
= Total Cover				
% Bare Ground in Herb Stratum <u>20</u>		% Cover of Biotic Crust _____		
Remarks:				

**SOIL**

Sampling Point: 14

**Profile Description: (Describe to the depth needed to document the indicator or confirm the absence of indicators.)**

Depth (inches)	Matrix		Redox Features				Texture	Remarks
	Color (moist)	%	Color (moist)	%	Type <sup>1</sup>	Loc <sup>2</sup>		

<sup>1</sup>Type: C=Concentration, D=Depletion, RM=Reduced Matrix, CS=Covered or Coated Sand Grains.     <sup>2</sup>Location: PL=Pore Lining, M=Matrix.

**Hydric Soil Indicators: (Applicable to all LRRs, unless otherwise noted.)**

<input type="checkbox"/> Histosol (A1)	<input type="checkbox"/> Sandy Redox (S5)	<input type="checkbox"/> 1 cm Muck (A9) (LRR C)
<input type="checkbox"/> Histic Epipedon (A2)	<input type="checkbox"/> Stripped Matrix (S6)	<input type="checkbox"/> 2 cm Muck (A10) (LRR B)
<input type="checkbox"/> Black Histic (A3)	<input type="checkbox"/> Loamy Mucky Mineral (F1)	<input type="checkbox"/> Reduced Vertic (F18)
<input type="checkbox"/> Hydrogen Sulfide (A4)	<input type="checkbox"/> Loamy Gleyed Matrix (F2)	<input type="checkbox"/> Red Parent Material (TF2)
<input type="checkbox"/> Stratified Layers (A5) (LRR C)	<input type="checkbox"/> Depleted Matrix (F3)	<input type="checkbox"/> Other (Explain in Remarks)
<input type="checkbox"/> 1 cm Muck (A9) (LRR D)	<input type="checkbox"/> Redox Dark Surface (F6)	
<input type="checkbox"/> Depleted Below Dark Surface (A11)	<input type="checkbox"/> Depleted Dark Surface (F7)	
<input type="checkbox"/> Thick Dark Surface (A12)	<input type="checkbox"/> Redox Depressions (F8)	
<input type="checkbox"/> Sandy Mucky Mineral (S1)	<input type="checkbox"/> Vernal Pools (F9)	
<input type="checkbox"/> Sandy Gleyed Matrix (S4)		

**Indicators for Problematic Hydric Soils<sup>3</sup>:**

<sup>3</sup>Indicators of hydrophytic vegetation and wetland hydrology must be present, unless disturbed or problematic.

**Restrictive Layer (if present):**

Type: \_\_\_\_\_

Depth (inches): \_\_\_\_\_

Hydric Soil Present? Yes \_\_\_\_\_ No \_\_\_\_\_

Remarks: *No soil pit taken as clearly defined irrigation canal with wetland vegetation & hydrology; upland beyond ditch is ag fields or roads*

**HYDROLOGY**

**Wetland Hydrology Indicators:**

<b>Primary Indicators (minimum of one required; check all that apply)</b>		<b>Secondary Indicators (2 or more required)</b>
<input type="checkbox"/> Surface Water (A1)	<input type="checkbox"/> Salt Crust (B11)	<input type="checkbox"/> Water Marks (B1) (Riverine)
<input type="checkbox"/> High Water Table (A2)	<input type="checkbox"/> Biotic Crust (B12)	<input type="checkbox"/> Sediment Deposits (B2) (Riverine)
<input type="checkbox"/> Saturation (A3)	<input type="checkbox"/> Aquatic Invertebrates (B13)	<input type="checkbox"/> Drift Deposits (B3) (Riverine)
<input type="checkbox"/> Water Marks (B1) (Nonriverine)	<input type="checkbox"/> Hydrogen Sulfide Odor (C1)	<input type="checkbox"/> Drainage Patterns (B10)
<input type="checkbox"/> Sediment Deposits (B2) (Nonriverine)	<input type="checkbox"/> Oxidized Rhizospheres along Living Roots (C3)	<input type="checkbox"/> Dry-Season Water Table (C2)
<input type="checkbox"/> Drift Deposits (B3) (Nonriverine)	<input type="checkbox"/> Presence of Reduced Iron (C4)	<input type="checkbox"/> Crayfish Burrows (C8)
<input checked="" type="checkbox"/> Surface Soil Cracks (B6)	<input type="checkbox"/> Recent Iron Reduction in Tilled Soils (C6)	<input type="checkbox"/> Saturation Visible on Aerial Imagery (C9)
<input checked="" type="checkbox"/> Inundation Visible on Aerial Imagery (B7)	<input type="checkbox"/> Thin Muck Surface (C7)	<input type="checkbox"/> Shallow Aquitard (D3)
<input type="checkbox"/> Water-Stained Leaves (B9)	<input type="checkbox"/> Other (Explain in Remarks)	<input type="checkbox"/> FAC-Neutral Test (D5)

**Field Observations:**

Surface Water Present? Yes \_\_\_\_\_ No  Depth (inches): \_\_\_\_\_

Water Table Present? Yes \_\_\_\_\_ No  Depth (inches): \_\_\_\_\_

Saturation Present? Yes \_\_\_\_\_ No  Depth (inches): \_\_\_\_\_  
(includes capillary fringe)

Wetland Hydrology Present? Yes  No \_\_\_\_\_

Describe Recorded Data (stream gauge, monitoring well, aerial photos, previous inspections), if available:

Remarks: *Large ditch/canal parallel to mendoza canal. Water appears to be pumped into ditch to south, across Marshall rd., which is currently full of water, and moved into this ditch periodically via control gate. Deep soil cracks present.*

(OTHWM = 16 feet)



**WETLAND DETERMINATION DATA FORM – Arid West Region**

Project/Site: Crow's Landing City/County: Stanislaus Sampling Date: 10/18/16  
 Applicant/Owner: Stanislaus County State: CA Sampling Point: 15  
 Investigator(s): C. Battaglia Section, Township, Range: \_\_\_\_\_  
 Landform (hillslope, terrace, etc.): terrace Local relief (concave, convex, none): \_\_\_\_\_ Slope (%): \_\_\_\_\_  
 Subregion (LRR): LRRL Lat: 37° 23' 48.44" N Long: 121° 8' 18.93" W Datum: \_\_\_\_\_  
 Soil Map Unit Name: \_\_\_\_\_ NWI classification: None

Are climatic / hydrologic conditions on the site typical for this time of year? Yes  No \_\_\_\_\_ (If no, explain in Remarks.)  
 Are Vegetation N, Soil N, or Hydrology N significantly disturbed? Are "Normal Circumstances" present? Yes  No \_\_\_\_\_  
 Are Vegetation N, Soil N, or Hydrology N naturally problematic? (If needed, explain any answers in Remarks.)

**SUMMARY OF FINDINGS – Attach site map showing sampling point locations, transects, important features, etc.**

Hydrophytic Vegetation Present? Yes _____ No <input checked="" type="checkbox"/> Hydric Soil Present? Yes _____ No _____ Wetland Hydrology Present? Yes _____ No _____	Is the Sampled Area within a Wetland? Yes _____ No <input checked="" type="checkbox"/>
Remarks: <u>roadside ditch dominated by upland vegetation and lacking indicators of hydrology; appears to convey runoff only in large rain events.</u>	

**VEGETATION – Use scientific names of plants.**

Tree Stratum (Plot size: _____)	Absolute % Cover	Dominant Species?	Indicator Status	Dominance Test worksheet:
1. _____				Number of Dominant Species That Are OBL, FACW, or FAC: <u>1</u> (A)
2. _____				Total Number of Dominant Species Across All Strata: <u>3</u> (B)
3. _____				Percent of Dominant Species That Are OBL, FACW, or FAC: <u>33</u> (A/B)
4. _____				
_____ = Total Cover				
Sapling/Shrub Stratum (Plot size: _____)	Absolute % Cover	Dominant Species?	Indicator Status	Prevalence Index worksheet:
1. _____				Total % Cover of: _____ Multiply by: _____
2. _____				OBL species _____ x 1 = _____
3. _____				FACW species _____ x 2 = _____
4. _____				FAC species _____ x 3 = _____
5. _____				FACU species _____ x 4 = _____
_____ = Total Cover				UPL species _____ x 5 = _____
				Column Totals: _____ (A) _____ (B)
				Prevalence Index = B/A = _____
Herb Stratum (Plot size: _____)	Absolute % Cover	Dominant Species?	Indicator Status	Hydrophytic Vegetation Indicators:
1. <u>Bromus diandrus</u>	<u>40</u>	<u>Y</u>	<u>NL</u>	<input type="checkbox"/> Dominance Test is >50%
2. <u>Conium maculatum</u>	<u>35</u>	<u>Y</u>	<u>FAC</u>	<input type="checkbox"/> Prevalence Index is ≤3.0 <sup>1</sup>
3. <u>Brassica nigra</u>	<u>10</u>	<u>Y</u>	<u>NL</u>	<input type="checkbox"/> Morphological Adaptations <sup>1</sup> (Provide supporting data in Remarks or on a separate sheet)
4. <u>Asclepias fascicularis</u>	<u>4</u>	<u>N</u>	<u>FAC</u>	<input type="checkbox"/> Problematic Hydrophytic Vegetation <sup>1</sup> (Explain)
5. <u>Grindelia camporum</u>	<u>3</u>	<u>N</u>	<u>FACW</u>	
6. <u>Carduus pycnocephalus</u>	<u>2</u>	<u>N</u>	<u>NL</u>	
7. <u>Rumex crispus</u>	<u>1</u>	<u>N</u>	<u>FAC</u>	
8. _____				
<u>95</u> = Total Cover				
<u>47.5/19</u>				
Woody Vine Stratum (Plot size: _____)	Absolute % Cover	Dominant Species?	Indicator Status	Hydrophytic Vegetation Present?
1. _____				Yes _____ No <input checked="" type="checkbox"/>
2. _____				
_____ = Total Cover				
% Bare Ground in Herb Stratum <u>5</u> % Cover of Biotic Crust _____				
Remarks: _____				

**SOIL**

Sampling Point: 15

Profile Description: (Describe to the depth needed to document the indicator or confirm the absence of indicators.)

Depth (inches)	Matrix		Redox Features				Texture	Remarks
	Color (moist)	%	Color (moist)	%	Type <sup>1</sup>	Loc <sup>2</sup>		

<sup>1</sup>Type: C=Concentration, D=Depletion, RM=Reduced Matrix, CS=Covered or Coated Sand Grains. <sup>2</sup>Location: PL=Pore Lining, M=Matrix.

<b>Hydric Soil Indicators: (Applicable to all LRRs, unless otherwise noted.)</b> <input type="checkbox"/> Histosol (A1) <input type="checkbox"/> Histic Epipedon (A2) <input type="checkbox"/> Black Histic (A3) <input type="checkbox"/> Hydrogen Sulfide (A4) <input type="checkbox"/> Stratified Layers (A5) (LRR C) <input type="checkbox"/> 1 cm Muck (A9) (LRR D) <input type="checkbox"/> Depleted Below Dark Surface (A11) <input type="checkbox"/> Thick Dark Surface (A12) <input type="checkbox"/> Sandy Mucky Mineral (S1) <input type="checkbox"/> Sandy Gleyed Matrix (S4)	<input type="checkbox"/> Sandy Redox (S5) <input type="checkbox"/> Stripped Matrix (S6) <input type="checkbox"/> Loamy Mucky Mineral (F1) <input type="checkbox"/> Loamy Gleyed Matrix (F2) <input type="checkbox"/> Depleted Matrix (F3) <input type="checkbox"/> Redox Dark Surface (F6) <input type="checkbox"/> Depleted Dark Surface (F7) <input type="checkbox"/> Redox Depressions (F8) <input type="checkbox"/> Vernal Pools (F9)	<b>Indicators for Problematic Hydric Soils<sup>3</sup>:</b> <input type="checkbox"/> 1 cm Muck (A9) (LRR C) <input type="checkbox"/> 2 cm Muck (A10) (LRR B) <input type="checkbox"/> Reduced Vertic (F18) <input type="checkbox"/> Red Parent Material (TF2) <input type="checkbox"/> Other (Explain in Remarks)
--	---	--

<sup>3</sup>Indicators of hydrophytic vegetation and wetland hydrology must be present, unless disturbed or problematic.

**Restrictive Layer (if present):**

Type: \_\_\_\_\_  
 Depth (inches): \_\_\_\_\_

Hydric Soil Present? Yes \_\_\_\_\_ No \_\_\_\_\_

Remarks: *man-made ditch clearly defined channel along edge of Interstate 5 southbound on-ramp. Ditch is dominated by upland vegetation and lacks HYD indicators*

**HYDROLOGY**

**Wetland Hydrology Indicators:**

Primary Indicators (minimum of one required; check all that apply)

Secondary Indicators (2 or more required)

<input type="checkbox"/> Surface Water (A1)	<input type="checkbox"/> Salt Crust (B11)	<input type="checkbox"/> Water Marks (B1) (Riverine)
<input type="checkbox"/> High Water Table (A2)	<input type="checkbox"/> Biotic Crust (B12)	<input type="checkbox"/> Sediment Deposits (B2) (Riverine)
<input type="checkbox"/> Saturation (A3)	<input type="checkbox"/> Aquatic Invertebrates (B13)	<input type="checkbox"/> Drift Deposits (B3) (Riverine)
<input type="checkbox"/> Water Marks (B1) (Nonriverine)	<input type="checkbox"/> Hydrogen Sulfide Odor (C1)	<input type="checkbox"/> Drainage Patterns (B10)
<input type="checkbox"/> Sediment Deposits (B2) (Nonriverine)	<input type="checkbox"/> Oxidized Rhizospheres along Living Roots (C3)	<input type="checkbox"/> Dry-Season Water Table (C2)
<input type="checkbox"/> Drift Deposits (B3) (Nonriverine)	<input type="checkbox"/> Presence of Reduced Iron (C4)	<input type="checkbox"/> Crayfish Burrows (C8)
<input type="checkbox"/> Surface Soil Cracks (B6)	<input type="checkbox"/> Recent Iron Reduction in Tilled Soils (C6)	<input type="checkbox"/> Saturation Visible on Aerial Imagery (C9)
<input type="checkbox"/> Inundation Visible on Aerial Imagery (B7)	<input type="checkbox"/> Thin Muck Surface (C7)	<input type="checkbox"/> Shallow Aquitard (D3)
<input type="checkbox"/> Water-Stained Leaves (B9)	<input type="checkbox"/> Other (Explain in Remarks)	<input type="checkbox"/> FAC-Neutral Test (D5)

**Field Observations:**

Surface Water Present? Yes \_\_\_\_\_ No  Depth (inches): \_\_\_\_\_  
 Water Table Present? Yes \_\_\_\_\_ No  Depth (inches): \_\_\_\_\_  
 Saturation Present? Yes \_\_\_\_\_ No  Depth (inches): \_\_\_\_\_  
 (includes capillary fringe)

Wetland Hydrology Present? Yes \_\_\_\_\_ No

Describe Recorded Data (stream gauge, monitoring well, aerial photos, previous inspections), if available:

Remarks: *man-made ditch parallel to Interstate 5 conveys storm runoff from upper watershed. An intermittent stream terminates upslope of Fink Road Landfill, but runoff from culverts and roadways makes it way into this ditch. NO HYD indicators, so OTHNM based on width of ditch ( $\bar{x} = 8'$ )*

**WETLAND DETERMINATION DATA FORM – Arid West Region**

Project/Site: Crow's Landing City/County: Stanislaus Sampling Date: 10/18/16  
 Applicant/Owner: Stanislaus County State: \_\_\_\_\_ Sampling Point: 16  
 Investigator(s): C. Battaglia Section, Township, Range: \_\_\_\_\_  
 Landform (hillslope, terrace, etc.): Terrace Local relief (concave, convex, none): None Slope (%): 1-2  
 Subregion (LRR): LRRC Lat: 37°23'50.20"N Long: 121°8'23.08"W Datum: NAD83  
 Soil Map Unit Name: \_\_\_\_\_ NWI classification: \_\_\_\_\_

Are climatic / hydrologic conditions on the site typical for this time of year? Yes  No \_\_\_\_\_ (If no, explain in Remarks.)  
 Are Vegetation N, Soil N, or Hydrology N significantly disturbed? Are "Normal Circumstances" present? Yes  No \_\_\_\_\_  
 Are Vegetation N, Soil N, or Hydrology N naturally problematic? (If needed, explain any answers in Remarks.)

**SUMMARY OF FINDINGS – Attach site map showing sampling point locations, transects, important features, etc.**

Hydrophytic Vegetation Present?	Yes _____ No <input checked="" type="checkbox"/>	Is the Sampled Area within a Wetland?	Yes _____ No <input checked="" type="checkbox"/>
Hydric Soil Present?	Yes _____ No _____		
Wetland Hydrology Present?	Yes _____ No _____		

Remarks: Roadside ditch dominated by upland vegetation and lacking indicators of hydrology; appears to convey storm runoff only during large flashy rain events. This ditch is likely

**VEGETATION – Use scientific names of plants.** realignment of historic Little Salado Creek

Tree Stratum (Plot size: _____)	Absolute % Cover	Dominant Species?	Indicator Status	Dominance Test worksheet:	
1. _____	_____	_____	_____	Number of Dominant Species That Are OBL, FACW, or FAC: <u>1</u>	(A)
2. _____	_____	_____	_____	Total Number of Dominant Species Across All Strata: <u>1</u>	(B)
3. _____	_____	_____	_____	Percent of Dominant Species That Are OBL, FACW, or FAC: <u>0</u>	(A/B)
4. _____	_____	_____	_____	= Total Cover	
Sapling/Shrub Stratum (Plot size: _____)			Prevalence Index worksheet:		
1. _____	_____	_____	_____	Total % Cover of: _____	Multiply by: _____
2. _____	_____	_____	_____	OBL species _____	x 1 = _____
3. _____	_____	_____	_____	FACW species _____	x 2 = _____
4. _____	_____	_____	_____	FAC species _____	x 3 = _____
5. _____	_____	_____	_____	FACU species _____	x 4 = _____
= Total Cover				UPL species _____	x 5 = _____
Herb Stratum (Plot size: _____)			Column Totals: _____ (A) _____ (B)		
1. <u>Bromus diandrus</u>	<u>70</u>	<u>Y</u>	<u>NL</u>	Prevalence Index = B/A = _____	
2. <u>Brassica nigra</u>	<u>10</u>	<u>N</u>	<u>NL</u>	Hydrophytic Vegetation Indicators:	
3. <u>Salsola tragus</u>	<u>10</u>	<u>N</u>	<u>FACU</u>	___ Dominance Test is >50%	
4. <u>Grindelia camporum</u>	<u>10</u>	<u>N</u>	<u>FACW</u>	___ Prevalence Index is ≤3.0 <sup>1</sup>	
5. _____	_____	_____	_____	___ Morphological Adaptations <sup>1</sup> (Provide supporting data in Remarks or on a separate sheet)	
6. _____	_____	_____	_____	___ Problematic Hydrophytic Vegetation <sup>1</sup> (Explain)	
7. _____	_____	_____	_____	___ Problematic Hydrophytic Vegetation <sup>1</sup> (Explain)	
8. _____	_____	_____	_____	___ Problematic Hydrophytic Vegetation <sup>1</sup> (Explain)	
= Total Cover				___ Problematic Hydrophytic Vegetation <sup>1</sup> (Explain)	
Woody Vine Stratum (Plot size: _____)			Hydrophytic Vegetation Present?		
1. _____	_____	_____	_____	Yes _____ No <input checked="" type="checkbox"/>	
2. _____	_____	_____	_____		
= Total Cover					
% Bare Ground in Herb Stratum <u>0</u>	% Cover of Biotic Crust _____				

Remarks: \_\_\_\_\_

**SOIL**

Sampling Point: 1b

Profile Description: (Describe to the depth needed to document the indicator or confirm the absence of indicators.)							
Depth (inches)	Matrix		Redox Features			Texture	Remarks
	Color (moist)	%	Color (moist)	%	Type <sup>1</sup>		

<sup>1</sup>Type: C=Concentration, D=Depletion, RM=Reduced Matrix, CS=Covered or Coated Sand Grains. <sup>2</sup>Location: PL=Pore Lining, M=Matrix.

Hydric Soil Indicators: (Applicable to all LRRs, unless otherwise noted.)	Indicators for Problematic Hydric Soils <sup>3</sup> :
<input type="checkbox"/> Histosol (A1) <input type="checkbox"/> Histic Epipedon (A2) <input type="checkbox"/> Black Histic (A3) <input type="checkbox"/> Hydrogen Sulfide (A4) <input type="checkbox"/> Stratified Layers (A5) (LRR C) <input type="checkbox"/> 1 cm Muck (A9) (LRR D) <input type="checkbox"/> Depleted Below Dark Surface (A11) <input type="checkbox"/> Thick Dark Surface (A12) <input type="checkbox"/> Sandy Mucky Mineral (S1) <input type="checkbox"/> Sandy Gleyed Matrix (S4)	<input type="checkbox"/> Sandy Redox (S5) <input type="checkbox"/> Stripped Matrix (S6) <input type="checkbox"/> Loamy Mucky Mineral (F1) <input type="checkbox"/> Loamy Gleyed Matrix (F2) <input type="checkbox"/> Depleted Matrix (F3) <input type="checkbox"/> Redox Dark Surface (F6) <input type="checkbox"/> Depleted Dark Surface (F7) <input type="checkbox"/> Redox Depressions (F8) <input type="checkbox"/> Vernal Pools (F9)

<input type="checkbox"/> 1 cm Muck (A9) (LRR C) <input type="checkbox"/> 2 cm Muck (A10) (LRR B) <input type="checkbox"/> Reduced Vertic (F18) <input type="checkbox"/> Red Parent Material (TF2) <input type="checkbox"/> Other (Explain in Remarks)	<sup>3</sup> Indicators of hydrophytic vegetation and wetland hydrology must be present, unless disturbed or problematic.
---	---

<b>Restrictive Layer (if present):</b> Type: _____ Depth (inches): _____	Hydric Soil Present? Yes _____ No _____
--	---

Remarks: *Man-made ditch paralleling Fink Rd. Ditch is dominated by upland veg and lacks HYD indicators.*

**HYDROLOGY**

Wetland Hydrology Indicators:		
Primary Indicators (minimum of one required; check all that apply)	Secondary Indicators (2 or more required)	
<input type="checkbox"/> Surface Water (A1) <input type="checkbox"/> High Water Table (A2) <input type="checkbox"/> Saturation (A3) <input type="checkbox"/> Water Marks (B1) (Nonriverine) <input type="checkbox"/> Sediment Deposits (B2) (Nonriverine) <input type="checkbox"/> Drift Deposits (B3) (Nonriverine) <input type="checkbox"/> Surface Soil Cracks (B6) <input type="checkbox"/> Inundation Visible on Aerial Imagery (B7) <input type="checkbox"/> Water-Stained Leaves (B9)	<input type="checkbox"/> Salt Crust (B11) <input type="checkbox"/> Biotic Crust (B12) <input type="checkbox"/> Aquatic Invertebrates (B13) <input type="checkbox"/> Hydrogen Sulfide Odor (C1) <input type="checkbox"/> Oxidized Rhizospheres along Living Roots (C3) <input type="checkbox"/> Presence of Reduced Iron (C4) <input type="checkbox"/> Recent Iron Reduction in Tilled Soils (C6) <input type="checkbox"/> Thin Muck Surface (C7) <input type="checkbox"/> Other (Explain in Remarks)	<input type="checkbox"/> Water Marks (B1) (Riverine) <input type="checkbox"/> Sediment Deposits (B2) (Riverine) <input type="checkbox"/> Drift Deposits (B3) (Riverine) <input type="checkbox"/> Drainage Patterns (B10) <input type="checkbox"/> Dry-Season Water Table (C2) <input type="checkbox"/> Crayfish Burrows (C8) <input type="checkbox"/> Saturation Visible on Aerial Imagery (C9) <input type="checkbox"/> Shallow Aquitard (D3) <input type="checkbox"/> FAC-Neutral Test (D5)

<b>Field Observations:</b> Surface Water Present? Yes _____ No <input checked="" type="checkbox"/> Depth (inches): _____ Water Table Present? Yes _____ No <input checked="" type="checkbox"/> Depth (inches): _____ Saturation Present? Yes _____ No <input checked="" type="checkbox"/> Depth (inches): _____ (includes capillary fringe)	Wetland Hydrology Present? Yes _____ No <input checked="" type="checkbox"/>
---	---

Describe Recorded Data (stream gauge, monitoring well, aerial photos, previous inspections), if available:

Remarks: *Roadside (Fink Rd.) ditch that conveys water under I-5 and the CA Aqueduct. Originates upstope in watershed in areas of agriculture. Located in area of historic Little Salado Ck. channel, but creek terminates upstream in agriculture fields. NO HYD indicators, so OTHWM based on avg. width of ditch. (OTHWM = 5')*

**WETLAND DETERMINATION DATA FORM – Arid West Region**

Project/Site: Crow's Landing City/County: Stanislaus Sampling Date: 11/18/16

Applicant/Owner: Stanislaus County State: CA Sampling Point: 17

Investigator(s): C. Battaglia Section, Township, Range: \_\_\_\_\_

Landform (hillslope, terrace, etc.): terrace Local relief (concave, convex, none): None Slope (%): 0

Subregion (LRR): LRRC Lat: 37°24'21.14"N Long: 121°5'27.21"W Datum: NAD83

(2) Soil Map Unit Name: capay clay, loamy substrate / zacharias clay NWI classification: None  
0-2 percent slopes / loam 0-2% slopes

Are climatic / hydrologic conditions on the site typical for this time of year? Yes  No \_\_\_\_\_ (If no, explain in Remarks.)

Are Vegetation N, Soil N, or Hydrology N significantly disturbed? Are "Normal Circumstances" present? Yes  No \_\_\_\_\_

Are Vegetation N, Soil N, or Hydrology N naturally problematic? (If needed, explain any answers in Remarks.)

**SUMMARY OF FINDINGS – Attach site map showing sampling point locations, transects, important features, etc.**

Hydrophytic Vegetation Present? Yes <input checked="" type="checkbox"/> No _____	Is the Sampled Area within a Wetland? Yes <input checked="" type="checkbox"/> No _____
Hydric Soil Present? Yes <input checked="" type="checkbox"/> No _____	
Wetland Hydrology Present? Yes <input checked="" type="checkbox"/> No _____	

Remarks: shallow ag ditch draining off tomato fields (Ike Crow Rd east of Bell rd) lots of soil disturbance from ag operations combined with irrigation create the conditions present

**VEGETATION – Use scientific names of plants.**

Tree Stratum (Plot size: _____)	Absolute % Cover	Dominant Species?	Indicator Status	Dominance Test worksheet:
1. _____				Number of Dominant Species That Are OBL, FACW, or FAC: <u>1</u> (A)
2. _____				Total Number of Dominant Species Across All Strata: <u>1</u> (B)
3. _____				Percent of Dominant Species That Are OBL, FACW, or FAC: <u>100</u> (A/B)
4. _____				
= Total Cover				
Sapling/Shrub Stratum (Plot size: _____)				Prevalence Index worksheet:
1. _____				Total % Cover of: _____ Multiply by: _____
2. _____				OBL species _____ x 1 = _____
3. _____				FACW species _____ x 2 = _____
4. _____				FAC species _____ x 3 = _____
5. _____				FACU species _____ x 4 = _____
= Total Cover				UPL species _____ x 5 = _____
				Column Totals: _____ (A) _____ (B)
				Prevalence Index = B/A = _____
Herb Stratum (Plot size: _____)				Hydrophytic Vegetation Indicators:
1. <u>Echinochloa crus-galli</u>	<u>40</u>	<u>Y</u>	<u>FAC</u>	<input checked="" type="checkbox"/> Dominance Test is >50%
2. <u>Cyperus eragrostis</u>	<u>5</u>	<u>N</u>	<u>FACW</u>	<input type="checkbox"/> Prevalence Index is ≤3.0 <sup>1</sup>
3. <u>Leptochloa fascicularis</u>	<u>5</u>	<u>N</u>	<u>NL</u>	<input type="checkbox"/> Morphological Adaptations <sup>1</sup> (Provide supporting data in Remarks or on a separate sheet)
4. <u>Erigeron bonariensis</u>	<u>21</u>	<u>N</u>	<u>FACU</u>	<input type="checkbox"/> Problematic Hydrophytic Vegetation <sup>1</sup> (Explain)
5. _____				
6. _____				
7. _____				
8. _____				
= Total Cover				
Woody Vine Stratum (Plot size: _____)				
1. _____				
2. _____				
= Total Cover				
% Bare Ground in Herb Stratum <u>50</u>	% Cover of Biotic Crust _____			
				Hydrophytic Vegetation Present? Yes <input checked="" type="checkbox"/> No _____

Remarks: \_\_\_\_\_

**SOIL**

Sampling Point: 17

**Profile Description: (Describe to the depth needed to document the indicator or confirm the absence of indicators.)**

Depth (inches)	Matrix		Redox Features				Texture	Remarks
	Color (moist)	%	Color (moist)	%	Type <sup>1</sup>	Loc <sup>2</sup>		

<sup>1</sup>Type: C=Concentration, D=Depletion, RM=Reduced Matrix, CS=Covered or Coated Sand Grains.    <sup>2</sup>Location: PL=Pore Lining, M=Matrix.

<b>Hydric Soil Indicators: (Applicable to all LRRs, unless otherwise noted.)</b>	<b>Indicators for Problematic Hydric Soils<sup>3</sup>:</b>
<input type="checkbox"/> Histosol (A1) <input type="checkbox"/> Histic Epipedon (A2) <input type="checkbox"/> Black Histic (A3) <input type="checkbox"/> Hydrogen Sulfide (A4) <input type="checkbox"/> Stratified Layers (A5) (LRR C) <input type="checkbox"/> 1 cm Muck (A9) (LRR D) <input type="checkbox"/> Depleted Below Dark Surface (A11) <input type="checkbox"/> Thick Dark Surface (A12) <input type="checkbox"/> Sandy Mucky Mineral (S1) <input type="checkbox"/> Sandy Gleyed Matrix (S4)	<input type="checkbox"/> Sandy Redox (S5) <input type="checkbox"/> Stripped Matrix (S6) <input type="checkbox"/> Loamy Mucky Mineral (F1) <input type="checkbox"/> Loamy Gleyed Matrix (F2) <input type="checkbox"/> Depleted Matrix (F3) <input type="checkbox"/> Redox Dark Surface (F6) <input type="checkbox"/> Depleted Dark Surface (F7) <input type="checkbox"/> Redox Depressions (F8) <input type="checkbox"/> Vernal Pools (F9)

<sup>3</sup>Indicators of hydrophytic vegetation and wetland hydrology must be present, unless disturbed or problematic.

**Restrictive Layer (if present):**  
 Type: \_\_\_\_\_  
 Depth (inches): \_\_\_\_\_

**Hydric Soil Present? Yes**  **No**

**Remarks:** *no soil pit taken as clearly defined irrigation ditch with wetland vegetation & hydrology; upland outside of ditch is roadside and tomato ag/tomato field.*

**HYDROLOGY**

**Wetland Hydrology Indicators:**

<u>Primary Indicators (minimum of one required; check all that apply)</u>	<u>Secondary Indicators (2 or more required)</u>
<input type="checkbox"/> Surface Water (A1) <input type="checkbox"/> High Water Table (A2) <input type="checkbox"/> Saturation (A3) <input type="checkbox"/> Water Marks (B1) (Nonriverine) <input type="checkbox"/> Sediment Deposits (B2) (Nonriverine) <input type="checkbox"/> Drift Deposits (B3) (Nonriverine) <input checked="" type="checkbox"/> Surface Soil Cracks (B6) <input checked="" type="checkbox"/> Inundation Visible on Aerial Imagery (B7) <input type="checkbox"/> Water-Stained Leaves (B9)	<input type="checkbox"/> Salt Crust (B11) <input type="checkbox"/> Biotic Crust (B12) <input type="checkbox"/> Aquatic Invertebrates (B13) <input type="checkbox"/> Hydrogen Sulfide Odor (C1) <input type="checkbox"/> Oxidized Rhizospheres along Living Roots (C3) <input type="checkbox"/> Presence of Reduced Iron (C4) <input type="checkbox"/> Recent Iron Reduction in Tilled Soils (C6) <input type="checkbox"/> Thin Muck Surface (C7) <input type="checkbox"/> Other (Explain in Remarks)

<input type="checkbox"/> Water Marks (B1) (Riverine) <input type="checkbox"/> Sediment Deposits (B2) (Riverine) <input type="checkbox"/> Drift Deposits (B3) (Riverine) <input checked="" type="checkbox"/> Drainage Patterns (B10) <input type="checkbox"/> Dry-Season Water Table (C2) <input type="checkbox"/> Crayfish Burrows (C8) <input type="checkbox"/> Saturation Visible on Aerial Imagery (C9) <input type="checkbox"/> Shallow Aquitard (D3) <input type="checkbox"/> FAC-Neutral Test (D5)
--

**Field Observations:**

Surface Water Present? Yes <input type="checkbox"/> No <input checked="" type="checkbox"/>	Depth (inches): _____
Water Table Present? Yes <input type="checkbox"/> No <input checked="" type="checkbox"/>	Depth (inches): _____
Saturation Present? (includes capillary fringe) Yes <input checked="" type="checkbox"/> No <input type="checkbox"/>	Depth (inches): _____

**Wetland Hydrology Present? Yes**  **No**

Describe Recorded Data (stream gauge, monitoring well, aerial photos, previous inspections), if available:

**Remarks:** *deep soil cracks & fine/sandy sediment accumulated in ditch from consistent runoff from ag/tomato field combined with disturbance of soils due to digging ditches and watering during growing season. (OHWM = 10 feet)*

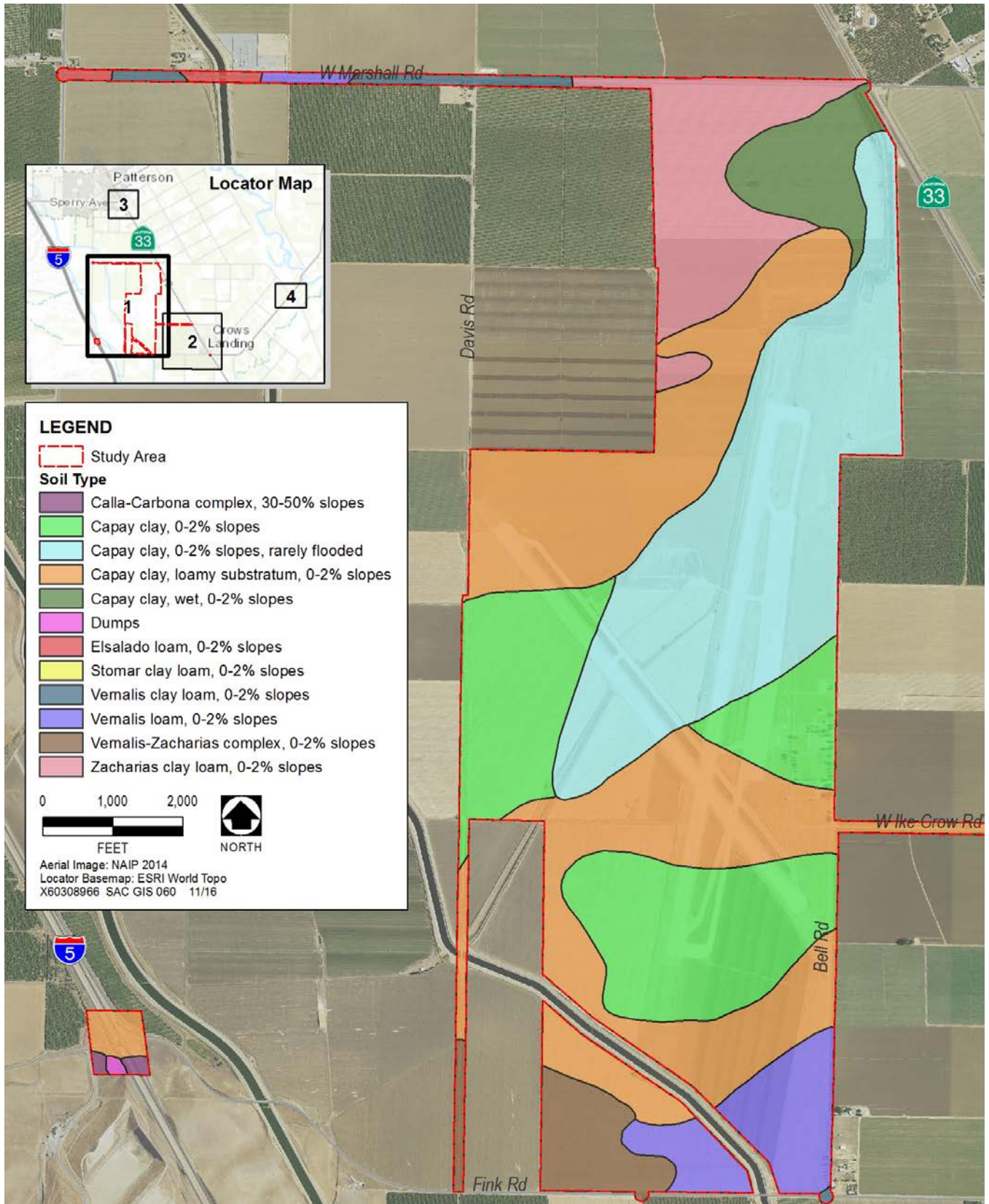
## **APPENDIX B**

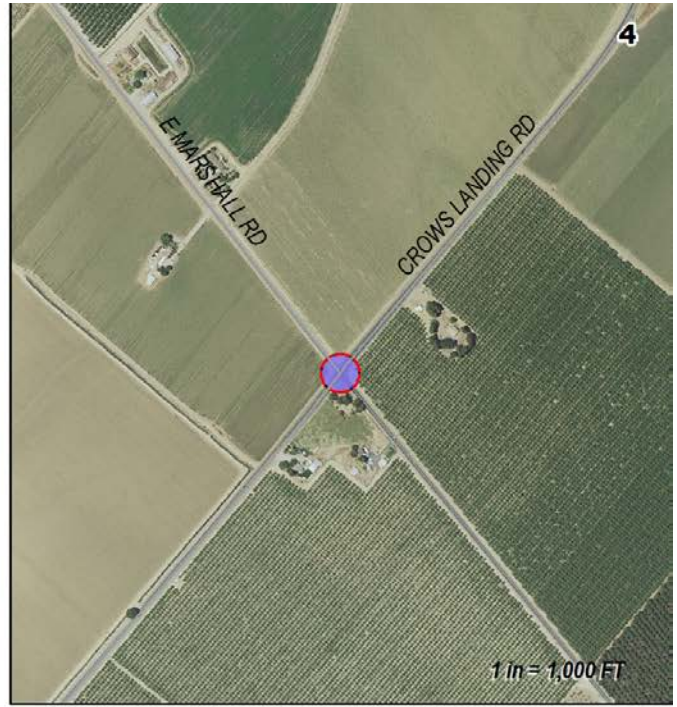
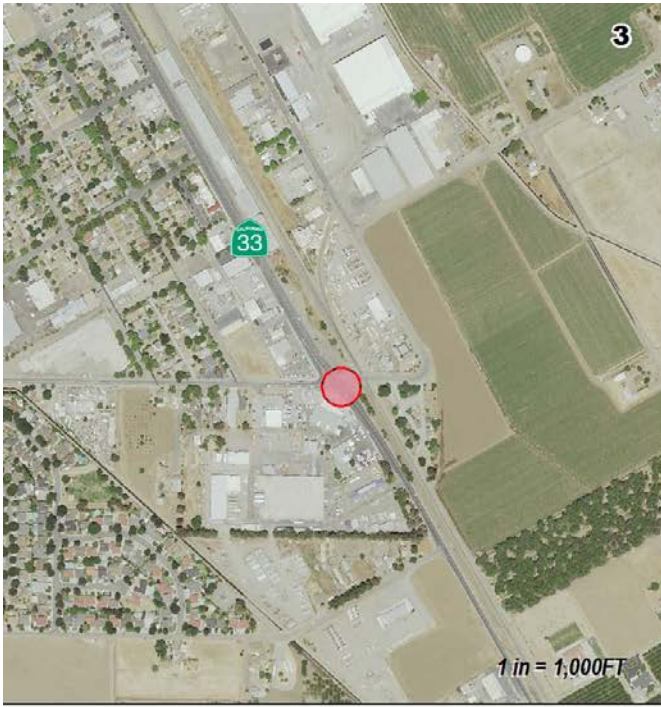
---

Soils Map









**LEGEND**

- |   |  |
|---|--|
| Study Area                                | Elsalado loam, 0-2% slopes             |
| Calla-Carbona complex, 30-50% slopes      | Stomar clay loam 0-2% slopes           |
| Capay clay, 0-2% slopes                   | Vemalis clay loam 0-2% slopes          |
| Capay clay, 0-2% slopes, rarely flooded   | Vemalis loam, 0-2% slopes              |
| Capay clay, loamy substratum, 0-2% slopes | Vemalis-Zacharias complex, 0-2% slopes |
| Capay clay, wet 0-2% slopes               | Zacharias clay loam, 0-2% slopes       |
| Dumps                                     |  |



Aerial Image: NAIP 2014  
 Locator Basemap: ESRI World Topo  
 X60308966 SAC GIS 061 11/16

## **APPENDIX C**

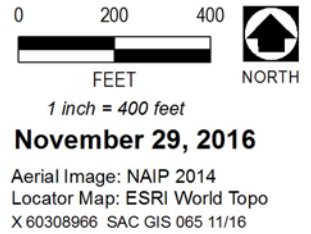
---

### Wetland Delineation Map





- LEGEND**
- ⊙ Sample Points
  - [ - - - ] Study Area (1641.36 ac)
  - Basin (BN) (0.05 ac)
  - Ditch (D) (2.56 ac)
  - Little Salado Creek (LSC) (3.6 ac)
  - Willow Scrub (WS) (1.01 ac)

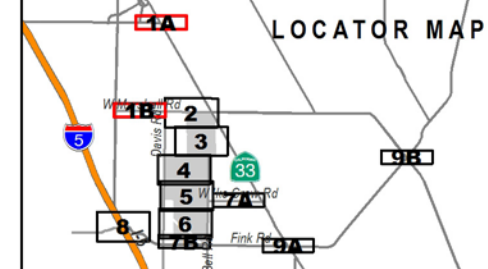


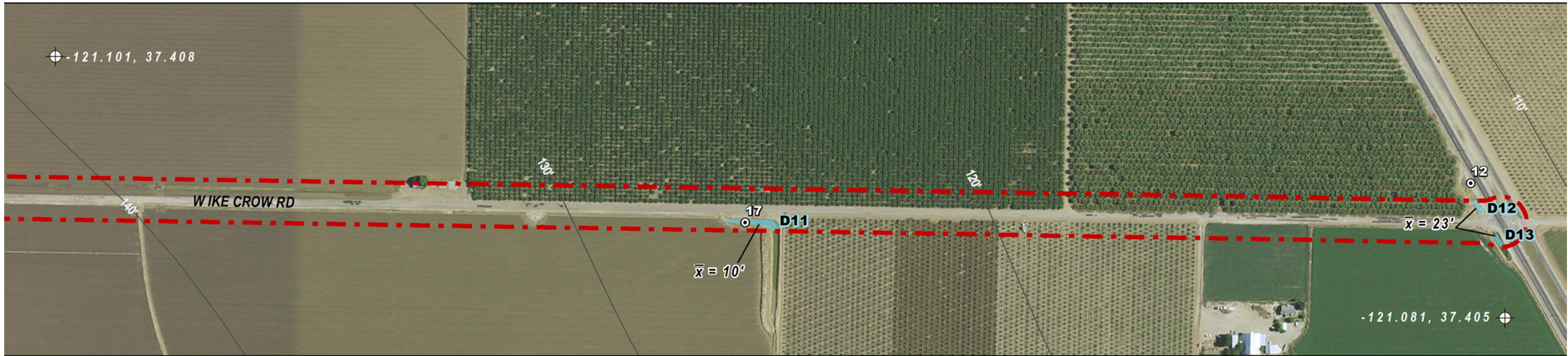
AQUATIC RESOURCE SUMMARY					AQUATIC RESOURCE SUMMARY					AQUATIC RESOURCE SUMMARY				
Aquatic Resource Name	Cowardin Code	Location (long/lat)	Acres	Linear Feet (of channel)	Aquatic Resource Name	Cowardin Code	Location (long/lat)	Acres	Linear Feet (of channel)	Aquatic Resource Name	Cowardin Code	Location (long/lat)	Acres	Linear Feet (of channel)
BN1	NA	-121.11300, 38.76741	0.04	NA	D5	R4SB5	-121.11000, 37.41207	0.65	2327.54	LSC1	R4SB5	-121.10200, 37.43044	1.29	4495.31
BN2	NA	-121.11300, 38.76762	0.00	NA	D6	R4SB7	-121.10700, 37.40331	0.34	4306.24	LSC2	R4SB7	-121.10800, 37.41860	0.99	5368.41
D1	R4SB5	-121.10100, 37.43260	0.18	799.71	D7	R4SB5	-121.10700, 37.42562	0.03	125.50	LSC3	R4SB7	-121.11600, 37.40881	0.96	2147.35
D2	R4SB7	-121.10700, 37.42532	0.01	104.99	D8	R4SB5	-121.13400, 37.43552	0.03	52.19	LSC4	R4SB5	-121.12100, 37.40156	0.01	32.11
D3	R4SB5	-121.10700, 37.42496	0.01	90.60	D9	R4SB5	-121.13400, 37.43521	0.03	57.23	LSC5	R4SB7	-121.13800, 37.39775	0.13	210.51
D4A	R4SB5	-121.10500, 37.42184	0.41	2955.07	D10	R4SB5	-121.10200, 37.43534	0.04	61.38	LSC6	R4SB7	-121.13900, 37.39738	0.20	212.49
D4B	R4SB5	-121.10500, 37.41573	0.23	1648.76	D11	R4SB5	-121.09100, 37.40587	0.11	250.00	WSC1	NA	-121.10100, 37.42770	1.01	NA
D4C	R4SB5	-121.10500, 37.41240	0.03	754.87	D12	R4SB5	-121.08100, 37.40609	0.03	55.94	<b>Total</b>			<b>7.21</b>	<b>124.29</b>
D4D	R4SB5	-121.10500, 37.41055	0.04	517.31	D13	R4SB5	-121.08100, 37.40572	0.03	67.93					
D4E	R4SB5	-121.10500, 37.40936	0.02	252.19	D14	R4SB5	-121.13800, 37.39675	0.13	394.65					
D4F	R4SB5	-121.10500, 37.40843	0.02	371.39	D15	R4SB5	-121.13800, 37.39827	0.14	370.97					
D4G	R4SB5	-121.10600, 37.40714	0.05	657.82										

Source: Cowardin 1979, AECOM 2016

**DIRECTIONS:**  
 Take Interstate 5 South to Fink Road  
 Turn left onto Fink Road  
 Turn left on Bell Road.

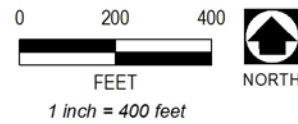
**DELINEATED BY:**  
 T. Beyerl and P.Brillante on November 25 and December 26, 2013; and October 18, 2016.





**LEGEND**

- ⊙ Sample Points
- [Red dashed line] Study Area (1641.36 ac)
- Blue Basin (BN) (0.05 ac)
- Light Blue Ditch (D) (2.56 ac)
- Light Green Little Salado Creek (LSC) (3.6 ac)
- Dark Green Willow Scrub (WS) (1.01 ac)



**November 29, 2016**

Aerial Image: NAIP 2014  
 Locator Map: ESRI World Topo  
 X 60308966 SAC GIS 066 11/16

AQUATIC RESOURCE SUMMARY				
Aquatic Resource Name	Cowardin Code	Location (longlat)	Acres	Linear Feet (of channel)
BN1	NA	-121.11300 38.76741	0.04	NA
BN2	NA	-121.11300 38.76762	0.00	NA
D1	R4SB5	-121.10100 37.43260	0.18	799.71
D2	R4SB7	-121.10700 37.42532	0.01	104.99
D3	R4SB5	-121.10700 37.42496	0.01	90.60
D4A	R4SB5	-121.10500 37.42184	0.41	2955.07
D4B	R4SB5	-121.10500 37.41573	0.23	1648.76
D4C	R4SB5	-121.10500 37.41240	0.03	754.87
D4D	R4SB5	-121.10500 37.41055	0.04	517.31
D4E	R4SB5	-121.10500 37.40936	0.02	252.19
D4F	R4SB5	-121.10500 37.40843	0.02	371.39
D4G	R4SB5	-121.10600 37.40714	0.05	657.82

AQUATIC RESOURCE SUMMARY				
Aquatic Resource Name	Cowardin Code	Location (longlat)	Acres	Linear Feet (of channel)
D5	R4SB5	-121.11000 37.41207	0.65	2327.54
D6	R4SB7	-121.10700 37.40331	0.34	4306.24
D7	R4SB5	-121.10700 37.42562	0.03	125.50
D8	R4SB5	-121.13400 37.43552	0.03	52.19
D9	R4SB5	-121.13400 37.43521	0.03	57.23
D10	R4SB5	-121.10200 37.43534	0.04	61.38
D11	R4SB5	-121.09100 37.40567	0.11	250.00
D12	R4SB5	-121.08100 37.40609	0.03	55.94
D13	R4SB5	-121.08100 37.40572	0.03	67.93
D14	R4SB5	-121.13800 37.39675	0.13	394.05
D15	R4SB5	-121.13800 37.39827	0.14	370.97

AQUATIC RESOURCE SUMMARY				
Aquatic Resource Name	Cowardin Code	Location (longlat)	Acres	Linear Feet (of channel)
LSC1	R4SB5	-121.10200 37.43044	1.29	4495.31
LSC2	R4SB7	-121.10800 37.41800	0.99	5368.41
LSC3	R4SB7	-121.11600 37.40881	0.98	2147.35
LSC4	R4SB5	-121.12100 37.40156	0.01	32.11
LSC5	R4SB7	-121.13800 37.39775	0.13	210.51
LSC6	R4SB7	-121.13900 37.39738	0.20	212.49
WSC1	NA	-121.10100 37.42770	1.01	NA
<b>Total</b>			<b>7.21</b>	<b>124.29</b>

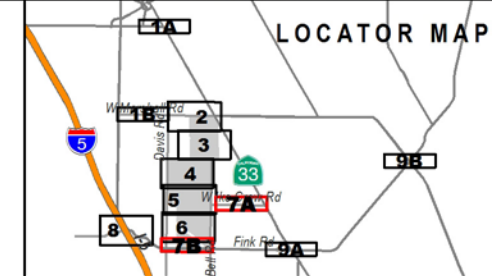
Source: Cowardin 1979, AECOM 2016

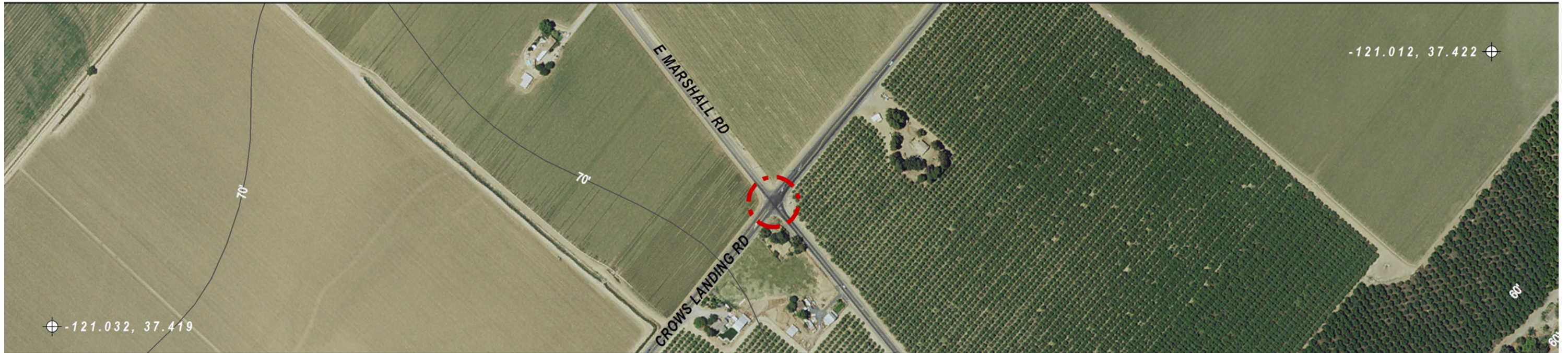
**DIRECTIONS:**

Take Interstate 5 South to Fink Road  
 Turn left onto Fink Road  
 Turn left on Bell Road.

**DELINEATED BY:**

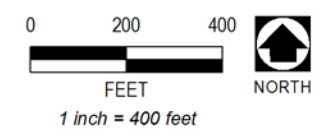
T. Beyerl and P. Brillante on November 25 and December 26, 2013; and October 18, 2016.





**LEGEND**

- ⊙ Sample Points
- [Red dashed box] Study Area (1641.36 ac)
- [Blue box] Basin (BN) (0.05 ac)
- [Light blue box] Ditch (D) (2.56 ac)
- [Light green box] Little Salado Creek (LSC) (3.6 ac)
- [Dark green box] Willow Scrub (WS) (1.01 ac)



**November 30, 2016**  
Aerial Image: NAIP 2014  
Locator Map: ESRI World Topo  
X 60308966 SAC GIS 067 11/16

**AQUATIC RESOURCE SUMMARY**

Aquatic Resource Name	Cowardin Code	Location (long/lat)	Acres	Linear Feet (of channel)
BN1	NA	-121.11300 38.76741	0.04	NA
BN2	NA	-121.11300 38.76762	0.05	NA
D1	R4SB5	-121.10100 37.43260	0.18	799.71
D2	R4SB7	-121.10700 37.42532	0.01	104.99
D3	R4SB5	-121.10700 37.42496	0.01	90.60
D4A	R4SB5	-121.10500 37.42184	0.41	2955.07
D4B	R4SB5	-121.10500 37.41573	0.23	1648.76
D4C	R4SB5	-121.10500 37.41240	0.03	754.87
D4D	R4SB5	-121.10500 37.41055	0.04	517.31
D4E	R4SB5	-121.10500 37.40936	0.02	252.19
D4F	R4SB5	-121.10500 37.40843	0.02	371.39
D4G	R4SB5	-121.10600 37.40714	0.05	657.82

**AQUATIC RESOURCE SUMMARY**

Aquatic Resource Name	Cowardin Code	Location (long/lat)	Acres	Linear Feet (of channel)
D5	R4SB5	-121.11000 37.41207	0.65	2327.54
D6	R4SB7	-121.10700 37.40331	0.34	4306.24
D7	R4SB5	-121.10700 37.42562	0.03	125.50
D8	R4SB5	-121.13400 37.43552	0.03	52.19
D9	R4SB5	-121.13400 37.43521	0.03	57.23
D10	R4SB5	-121.10200 37.43534	0.04	61.38
D11	R4SB5	-121.09100 37.40587	0.11	250.00
D12	R4SB5	-121.08100 37.40609	0.03	55.94
D13	R4SB5	-121.08100 37.40572	0.03	67.93
D14	R4SB5	-121.13800 37.39675	0.13	394.65
D15	R4SB5	-121.13800 37.39827	0.14	370.97

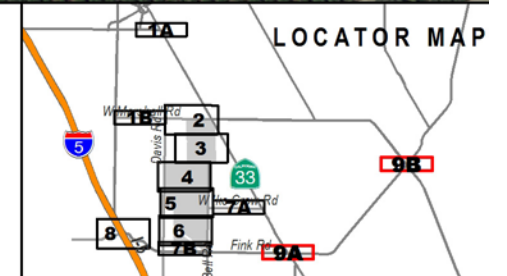
**AQUATIC RESOURCE SUMMARY**

Aquatic Resource Name	Cowardin Code	Location (long/lat)	Acres	Linear Feet (of channel)
LSC1	R4SB5	-121.10200 37.43044	1.29	4495.31
LSC2	R4SB7	-121.10800 37.41860	0.99	5368.41
LSC3	R4SB7	-121.11600 37.40881	0.98	2147.35
LSC4	R4SB5	-121.12100 37.40156	0.01	32.11
LSC5	R4SB7	-121.13800 37.39775	0.13	210.51
LSC6	R4SB7	-121.13900 37.39738	0.20	212.49
WSC1	NA	-121.10100 37.42770	1.01	NA
<b>Total</b>			<b>7.21</b>	<b>124.29</b>

Source: Cowardin 1979, AECOM 2016

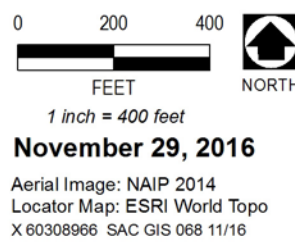
**DIRECTIONS:**  
Take Interstate 5 South to Fink Road  
Turn left onto Fink Road  
Turn left on Bell Road.

**DELINEATED BY:**  
T. Beyerl and P.Brillante on November 25 and December 26, 2013; and October 18, 2016.





- LEGEND**
- Sample Points
  - [Red Dashed Line] Study Area (1641.36 ac)
  - [Blue Box] Basin (BN) (0.05 ac)
  - [Light Blue Box] Ditch (D) (2.56 ac)
  - [Green Box] Little Salado Creek (LSC) (3.6 ac)
  - [Dark Green Box] Willow Scrub (WS) (1.01 ac)



AQUATIC RESOURCE SUMMARY				
Aquatic Resources Name	Cowardin Code	Location (longlat)	Acres	Linear Feet (of channel)
BN1	NA	-121.11300 38.76741	0.04	NA
BN2	NA	-121.11300 38.76762	0.00	NA
D1	R4S85	-121.10100 37.43260	0.18	799.71
D2	R4S87	-121.10700 37.42532	0.01	104.99
D3	R4S85	-121.10700 37.42496	0.01	90.60
D4A	R4S85	-121.10500 37.42184	0.41	2955.07
D4B	R4S85	-121.10500 37.41573	0.23	1648.76
D4C	R4S85	-121.10500 37.41240	0.03	754.87
D4D	R4S85	-121.10500 37.41055	0.04	517.31
D4E	R4S85	-121.10500 37.40936	0.02	252.19
D4F	R4S85	-121.10500 37.40843	0.02	371.39
D4G	R4S85	-121.10000 37.40714	0.05	657.82

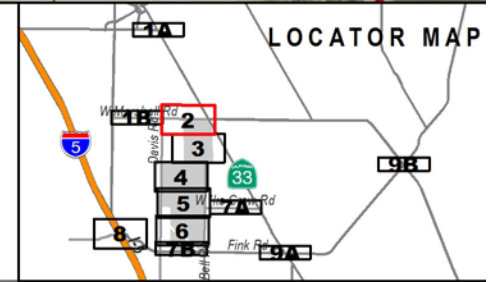
AQUATIC RESOURCE SUMMARY				
Aquatic Resources Name	Cowardin Code	Location (longlat)	Acres	Linear Feet (of channel)
D5	R4S85	-121.11000 37.41207	0.65	2327.54
D6	R4S87	-121.10700 37.40331	0.34	4306.24
D7	R4S85	-121.10700 37.42562	0.03	125.50
D8	R4S85	-121.13400 37.43552	0.03	52.19
D9	R4S85	-121.13400 37.43521	0.03	57.23
D10	R4S85	-121.10200 37.43534	0.04	61.38
D11	R4S85	-121.09100 37.40587	0.11	250.00
D12	R4S85	-121.08100 37.40609	0.03	55.94
D13	R4S85	-121.08100 37.40572	0.03	67.93
D14	R4S85	-121.13800 37.39675	0.13	394.05
D15	R4S85	-121.13800 37.39827	0.14	370.97

AQUATIC RESOURCE SUMMARY				
Aquatic Resources Name	Cowardin Code	Location (longlat)	Acres	Linear Feet (of channel)
LSC1	R4S85	-121.10200 37.43044	1.29	4495.31
LSC2	R4S87	-121.10800 37.41860	0.99	5368.41
LSC3	R4S87	-121.11600 37.40881	0.98	2147.35
LSC4	R4S85	-121.12100 37.40156	0.01	32.11
LSC5	R4S87	-121.13800 37.39775	0.13	210.51
LSC6	R4S87	-121.13900 37.39738	0.20	212.49
WSC1	NA	-121.10100 37.42770	1.01	NA
<b>Total</b>			<b>7.21</b>	<b>124.29</b>

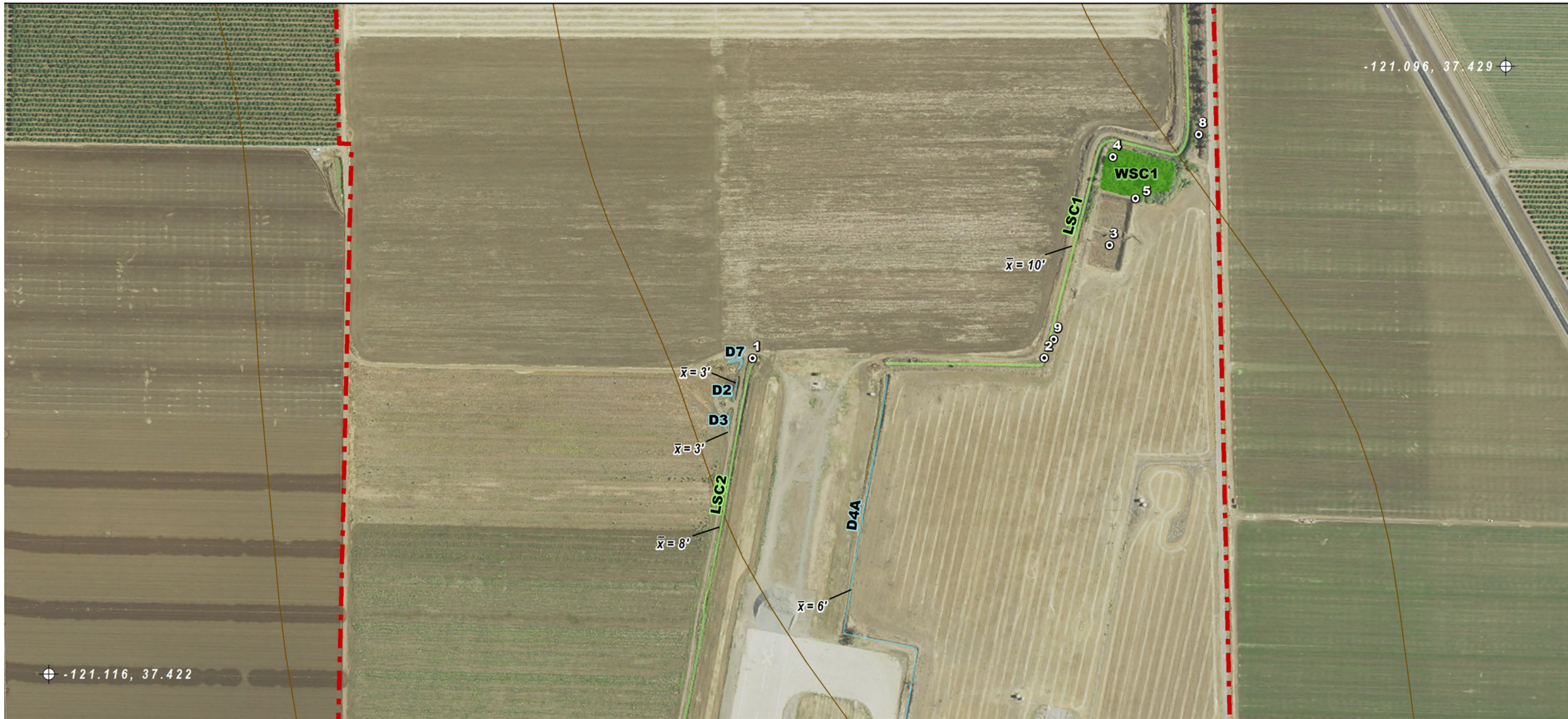
Source: Cowardin 1979, AECOM 2016

**DIRECTIONS:**  
 Take Interstate 5 South to Fink Road  
 Turn left onto Fink Road  
 Turn left on Bell Road.

**DELINEATED BY:**  
 T. Beyerl and P.Brillante on November 25 and December 26, 2013; and October 18, 2016.

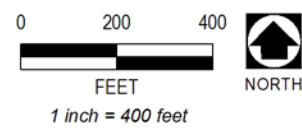






**LEGEND**

- Sample Points
- Study Area (1641.36 ac)
- Basin (BN) (0.05 ac)
- Ditch (D) (2.56 ac)
- Little Salado Creek (LSC) (3.6 ac)
- Willow Scrub (WS) (1.01 ac)



**November 29, 2016**

Aerial Image: NAIP 2014  
Locator Map: ESRI World Topo  
X 60308966 SAC GIS 069 11/16

**AQUATIC RESOURCE SUMMARY**

Aquatic Resource Name	Cowardin Code	Location (longlat)	Acres	Linear Feet (of channel)
BN1	NA	-121.11300 38.76741	0.04	NA
BN2	NA	-121.11300 38.76762	0.00	NA
D1	R4SB5	-121.10100 37.43260	0.18	799.71
D2	R4SB7	-121.10700 37.42532	0.01	104.99
D3	R4SB5	-121.10700 37.42496	0.01	90.60
D4A	R4SB5	-121.10500 37.42184	0.41	2955.07
D4B	R4SB5	-121.10500 37.41573	0.23	1648.76
D4C	R4SB5	-121.10500 37.41240	0.03	754.87
D4D	R4SB5	-121.10500 37.41055	0.04	517.31
D4E	R4SB5	-121.10500 37.40936	0.02	252.19
D4F	R4SB5	-121.10500 37.40843	0.02	371.39
D4G	R4SB5	-121.10600 37.40714	0.05	657.82

**AQUATIC RESOURCE SUMMARY**

Aquatic Resource Name	Cowardin Code	Location (longlat)	Acres	Linear Feet (of channel)
D5	R4SB5	-121.11000 37.41207	0.65	2327.54
D6	R4SB7	-121.10700 37.40331	0.34	4306.24
D7	R4SB5	-121.10700 37.42562	0.03	125.50
D8	R4SB5	-121.13400 37.43552	0.03	52.19
D9	R4SB5	-121.13400 37.43521	0.03	57.23
D10	R4SB5	-121.10200 37.43534	0.04	61.38
D11	R4SB5	-121.09100 37.40587	0.11	250.00
D12	R4SB5	-121.08100 37.40609	0.03	55.94
D13	R4SB5	-121.08100 37.40572	0.03	67.93
D14	R4SB5	-121.13800 37.39675	0.13	394.65
D15	R4SB5	-121.13800 37.39827	0.14	370.97

**AQUATIC RESOURCE SUMMARY**

Aquatic Resource Name	Cowardin Code	Location (longlat)	Acres	Linear Feet (of channel)
LSC1	R4SB5	-121.10200 37.43044	1.29	4495.31
LSC2	R4SB7	-121.10800 37.41800	0.99	5368.41
LSC3	R4SB7	-121.11600 37.40881	0.96	2147.35
LSC4	R4SB5	-121.12100 37.40156	0.01	32.11
LSC5	R4SB7	-121.13800 37.39775	0.13	210.51
LSC6	R4SB7	-121.13900 37.39738	0.20	212.49
WSC1	NA	-121.10100 37.42770	1.01	NA
<b>Total</b>			<b>7.21</b>	<b>124.29</b>

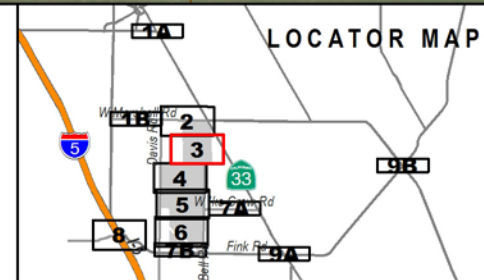
Source: Cowardin 1979, AECOM 2016

**DIRECTIONS:**

Take Interstate 5 South to Fink Road  
Turn left onto Fink Road  
Turn left on Bell Road.

**DELINEATED BY:**

T. Beyerl and P.Brillante on November 25 and December 26, 2013; and October 18, 2016.





- LEGEND**
- ⊙ Sample Points
  - [Red dashed line] Study Area (1641.36 ac)
  - Basin (BN) (0.05 ac)
  - Ditch (D) (2.56 ac)
  - Little Salado Creek (LSC) (3.6 ac)
  - Willow Scrub (WS) (1.01 ac)

0 200 400  
FEET  
NORTH

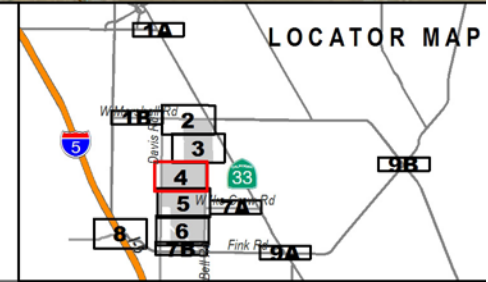
1 inch = 400 feet  
**November 29, 2016**  
Aerial Image: NAIP 2014  
Locator Map: ESRI World Topo  
X 60308966 SAC GIS 070 11/16

AQUATIC RESOURCE SUMMARY					AQUATIC RESOURCE SUMMARY					AQUATIC RESOURCE SUMMARY				
Aquatic Resources Name	Cowardin Code	Location (longlat)	Acres	Linear Feet (of channel)	Aquatic Resources Name	Cowardin Code	Location (longlat)	Acres	Linear Feet (of channel)	Aquatic Resources Name	Cowardin Code	Location (longlat)	Acres	Linear Feet (of channel)
BN1	NA	-121.11300, 38.76741	0.04	NA	D5	R4SB5	-121.11000, 37.41207	0.65	2327.54	LSC1	R4SB5	-121.10200, 37.43044	1.29	4495.31
BN2	NA	-121.11300, 38.76762	0.00	NA	D6	R4SB7	-121.10700, 37.40331	0.34	4306.24	LSC2	R4SB7	-121.10800, 37.41860	0.99	5368.41
D1	R4SB5	-121.10100, 37.43260	0.18	799.71	D7	R4SB5	-121.10700, 37.42562	0.03	125.50	LSC3	R4SB7	-121.11600, 37.40881	0.98	2147.35
D2	R4SB7	-121.10700, 37.42532	0.01	104.99	D8	R4SB5	-121.13400, 37.43552	0.03	52.19	LSC4	R4SB5	-121.12100, 37.40156	0.01	32.11
D3	R4SB5	-121.10700, 37.42496	0.01	90.60	D9	R4SB5	-121.13400, 37.43521	0.03	57.23	LSC5	R4SB7	-121.13800, 37.39775	0.13	210.51
D4A	R4SB5	-121.10500, 37.42184	0.41	2955.07	D10	R4SB5	-121.10200, 37.43534	0.04	61.38	LSC6	R4SB7	-121.13900, 37.39738	0.20	212.49
D4B	R4SB5	-121.10500, 37.41573	0.23	1648.76	D11	R4SB5	-121.09100, 37.40587	0.11	250.00	WSC1	NA	-121.10100, 37.42770	1.01	NA
D4C	R4SB5	-121.10500, 37.41240	0.03	754.87	D12	R4SB5	-121.08100, 37.40609	0.03	55.94	<b>Total</b>			<b>7.21</b>	<b>124.29</b>
D4D	R4SB5	-121.10500, 37.41055	0.04	517.31	D13	R4SB5	-121.08100, 37.40572	0.03	67.93					
D4E	R4SB5	-121.10500, 37.40936	0.02	252.19	D14	R4SB5	-121.13800, 37.39675	0.13	394.05					
D4F	R4SB5	-121.10500, 37.40843	0.02	371.39	D15	R4SB5	-121.13800, 37.39827	0.14	370.97					
D4G	R4SB5	-121.10600, 37.40714	0.05	657.82										

Source: Cowardin 1979, AECOM 2016

**DIRECTIONS:**  
Take Interstate 5 South to Fink Road  
Turn left onto Fink Road  
Turn left on Bell Road.

**DELINEATED BY:**  
T. Beyerl and P.Brillante on November 25 and December 26, 2013; and October 18, 2016.





- LEGEND**
- Sample Points
  - [Red dashed line] Study Area (1641.36 ac)
  - [Blue line] Basin (BN) (0.05 ac)
  - [Light blue line] Ditch (D) (2.56 ac)
  - [Green line] Little Salado Creek (LSC) (3.6 ac)
  - [Dark green line] Willow Scrub (WS) (1.01 ac)

0 200 400  
FEET  
NORTH

**November 29, 2016**  
Aerial Image: NAIP 2014  
Locator Map: ESRI World Topo  
X 60308966 SAC GIS 071 11/16

Aquatic Resource Name	Cowardin Code	Location (longlat)	Acres	Linear Feet (of channel)
BN1	NA	-121.11300, 38.76741	0.04	NA
BN2	NA	-121.11300, 38.76762	0.00	NA
D1	R4SB5	-121.10100, 37.43260	0.18	799.71
D2	R4SB7	-121.10700, 37.42532	0.01	104.99
D3	R4SB5	-121.10700, 37.42496	0.01	90.60
D4A	R4SB5	-121.10500, 37.42184	0.41	2955.07
D4B	R4SB5	-121.10500, 37.41573	0.23	1648.76
D4C	R4SB5	-121.10500, 37.41240	0.03	754.87
D4D	R4SB5	-121.10500, 37.41055	0.04	517.31
D4E	R4SB5	-121.10500, 37.40936	0.02	252.19
D4F	R4SB5	-121.10500, 37.40843	0.02	371.39
D4G	R4SB5	-121.10600, 37.40714	0.05	657.82

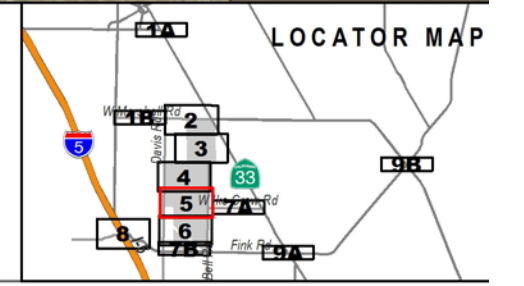
Aquatic Resource Name	Cowardin Code	Location (longlat)	Acres	Linear Feet (of channel)
D5	R4SB5	-121.11000, 37.41207	0.65	2327.54
D6	R4SB7	-121.10700, 37.40331	0.34	4306.24
D7	R4SB5	-121.10700, 37.42562	0.03	125.50
D8	R4SB5	-121.13400, 37.43552	0.03	52.19
D9	R4SB5	-121.13400, 37.43521	0.03	57.23
D10	R4SB5	-121.10200, 37.43534	0.04	61.38
D11	R4SB5	-121.09100, 37.40587	0.11	250.00
D12	R4SB5	-121.08100, 37.40609	0.03	55.94
D13	R4SB5	-121.08100, 37.40572	0.03	67.93
D14	R4SB5	-121.13800, 37.39675	0.13	394.65
D15	R4SB5	-121.13800, 37.39827	0.14	370.97

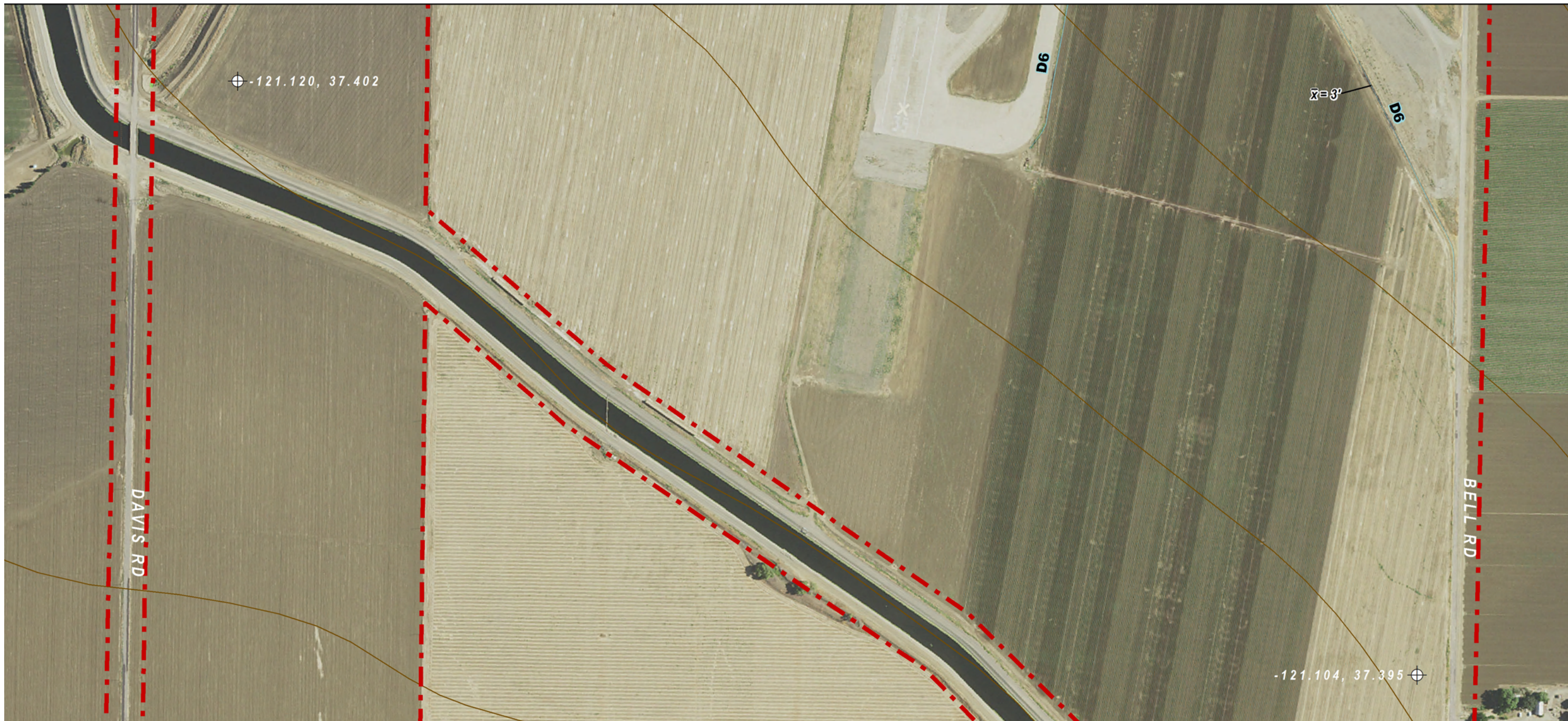
Aquatic Resource Name	Cowardin Code	Location (longlat)	Acres	Linear Feet (of channel)
LSC1	R4SB5	-121.10200, 37.43044	1.29	4495.31
LSC2	R4SB7	-121.10800, 37.41860	0.99	5368.41
LSC3	R4SB7	-121.11600, 37.40881	0.96	2147.35
LSC4	R4SB5	-121.12100, 37.40156	0.01	32.11
LSC5	R4SB7	-121.13800, 37.39775	0.13	210.51
LSC6	R4SB7	-121.13900, 37.39738	0.20	212.49
WSC1	NA	-121.10100, 37.42770	1.01	NA
<b>Total</b>			<b>7.21</b>	<b>124.29</b>

Source: Cowardin 1979, AECOM 2016

**DIRECTIONS:**  
Take Interstate 5 South to Fink Road  
Turn left onto Fink Road  
Turn left on Bell Road.

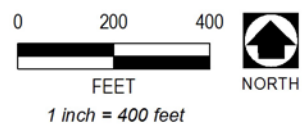
**DELINEATED BY:**  
T. Beyerl and P.Brillante on November 25 and December 26, 2013; and October 18, 2016.





**LEGEND**

- ⊙ Sample Points
- [Red dashed line] Study Area (1641.36 ac)
- Basin (BN) (0.05 ac)
- Ditch (D) (2.56 ac)
- Little Salado Creek (LSC) (3.6 ac)
- Willow Scrub (WS) (1.01 ac)



**November 29, 2016**

Aerial Image: NAIP 2014  
 Locator Map: ESRI World Topo  
 X 60308966 SAC GIS 072 11/16

AQUATIC RESOURCE SUMMARY				
Aquatic Resource Name	Cowardin Code	Location (long/lat)	Acres	Linear Feet (of channel)
BN1	NA	-121.11300 38.76741	0.04	NA
BN2	NA	-121.11300 38.76762	0.00	NA
D1	R4SB5	-121.10100 37.43260	0.18	799.71
D2	R4SB7	-121.10700 37.42532	0.01	104.99
D3	R4SB5	-121.10700 37.42496	0.01	90.60
D4A	R4SB5	-121.10500 37.42184	0.41	2955.07
D4B	R4SB5	-121.10500 37.41573	0.23	1648.76
D4C	R4SB5	-121.10500 37.41240	0.03	754.87
D4D	R4SB5	-121.10500 37.41055	0.04	517.31
D4E	R4SB5	-121.10500 37.40936	0.02	252.19
D4F	R4SB5	-121.10500 37.40843	0.02	371.39
D4G	R4SB5	-121.10600 37.40714	0.05	657.82

AQUATIC RESOURCE SUMMARY				
Aquatic Resource Name	Cowardin Code	Location (long/lat)	Acres	Linear Feet (of channel)
D5	R4SB5	-121.11000 37.41207	0.65	2327.54
D6	R4SB7	-121.10700 37.40331	0.34	4306.24
D7	R4SB5	-121.10700 37.42562	0.03	125.50
D8	R4SB5	-121.13400 37.43552	0.03	52.19
D9	R4SB5	-121.13400 37.43521	0.03	57.23
D10	R4SB5	-121.10200 37.43534	0.04	61.38
D11	R4SB5	-121.09100 37.40567	0.11	250.00
D12	R4SB5	-121.08100 37.40609	0.03	55.94
D13	R4SB5	-121.08100 37.40572	0.03	67.93
D14	R4SB5	-121.13800 37.39675	0.13	394.65
D15	R4SB5	-121.13800 37.39827	0.14	370.97

AQUATIC RESOURCE SUMMARY				
Aquatic Resource Name	Cowardin Code	Location (long/lat)	Acres	Linear Feet (of channel)
LSC1	R4SB5	-121.10200 37.43044	1.29	4495.31
LSC2	R4SB7	-121.10800 37.41800	0.99	5368.41
LSC3	R4SB7	-121.11600 37.40881	0.98	2147.35
LSC4	R4SB5	-121.12100 37.40156	0.01	32.11
LSC5	R4SB7	-121.13800 37.39775	0.13	210.51
LSC6	R4SB7	-121.13900 37.39738	0.20	212.49
WSC1	NA	-121.10100 37.42770	1.01	NA
<b>Total</b>			<b>7.21</b>	<b>124.29</b>

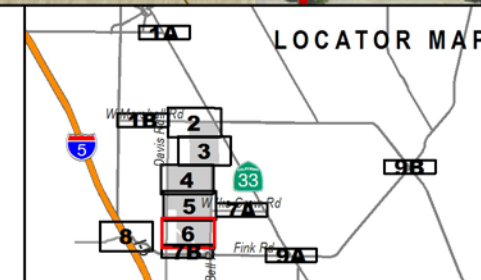
Source: Cowardin 1979, AECOM 2016

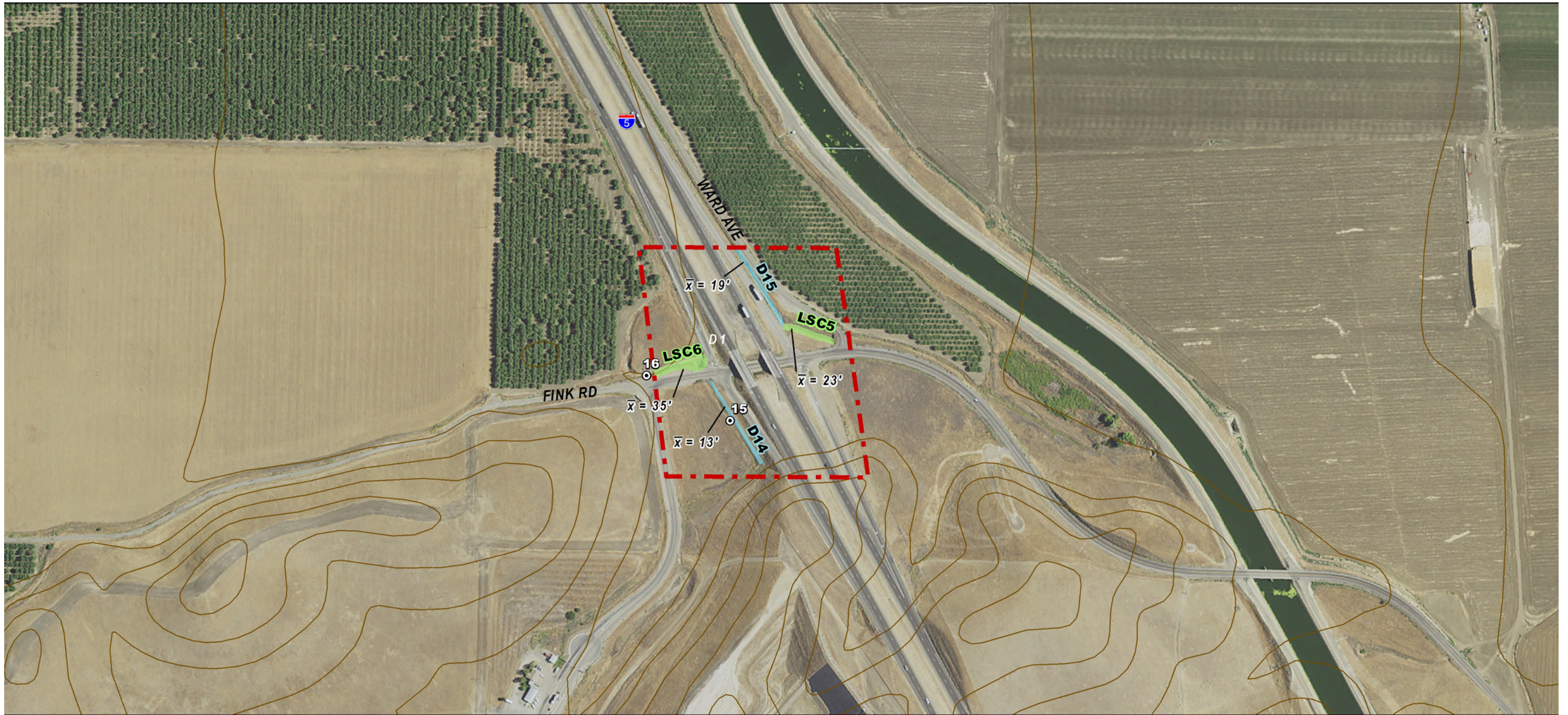
**DIRECTIONS:**

Take Interstate 5 South to Fink Road  
 Turn left onto Fink Road  
 Turn left on Bell Road.

**DELINEATED BY:**

T. Beyerl and P.Brillante on November 25 and December 26, 2013; and October 18, 2016.





- LEGEND**
- Sample Points
  - [Red dashed box] Study Area (1641.36 ac)
  - [Blue box] Basin (BN) (0.05 ac)
  - [Light blue box] Ditch (D) (2.56 ac)
  - [Light green box] Little Salado Creek (LSC) (3.6 ac)
  - [Dark green box] Willow Scrub (WS) (1.01 ac)

0 200 400  
FEET  
NORTH

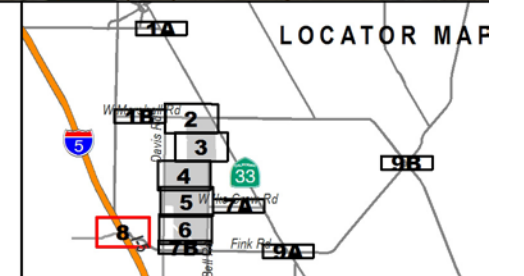
**November 29, 2016**  
Aerial Image: NAIP 2014  
Locator Map: ESRI World Topo  
X 60308966 SAC GIS 073 11/16

AQUATIC RESOURCE SUMMARY					AQUATIC RESOURCE SUMMARY					AQUATIC RESOURCE SUMMARY				
Aquatic Resource Name	Cowardin Code	Location (longlat)	Acres	Linear Feet (of channel)	Aquatic Resource Name	Cowardin Code	Location (longlat)	Acres	Linear Feet (of channel)	Aquatic Resource Name	Cowardin Code	Location (longlat)	Acres	Linear Feet (of channel)
BN1	NA	-121.11300, 38.76741	0.04	NA	D5	R4SB5	-121.11000, 37.41207	0.65	2327.54	LSC1	R4SB5	-121.10200, 37.43044	1.29	4495.31
BN2	NA	-121.11300, 38.76762	0.06	NA	D6	R4SB7	-121.10700, 37.40331	0.34	4306.24	LSC2	R4SB7	-121.10800, 37.41860	0.99	5368.41
D1	R4SB5	-121.10100, 37.43260	0.18	799.71	D7	R4SB5	-121.10700, 37.42562	0.03	125.50	LSC3	R4SB7	-121.11600, 37.40881	0.98	2147.35
D2	R4SB7	-121.10700, 37.42532	0.01	104.99	D8	R4SB5	-121.13400, 37.43552	0.03	52.19	LSC4	R4SB5	-121.12100, 37.40156	0.01	32.11
D3	R4SB5	-121.10700, 37.42496	0.01	90.60	D9	R4SB5	-121.13400, 37.43521	0.03	57.23	LSC5	R4SB7	-121.13800, 37.39775	0.13	210.51
D4A	R4SB5	-121.10500, 37.42184	0.41	2955.07	D10	R4SB5	-121.10200, 37.43534	0.04	61.38	LSC6	R4SB7	-121.13900, 37.39738	0.20	212.49
D4B	R4SB5	-121.10500, 37.41573	0.23	1648.76	D11	R4SB5	-121.09100, 37.40587	0.11	250.00	WSC1	NA	-121.10100, 37.42770	1.01	NA
D4C	R4SB5	-121.10500, 37.41240	0.03	754.87	D12	R4SB5	-121.08100, 37.40609	0.03	55.94	<b>Total</b>			<b>7.21</b>	<b>124.29</b>
D4D	R4SB5	-121.10500, 37.41055	0.04	517.31	D13	R4SB5	-121.08100, 37.40572	0.03	67.93					
D4E	R4SB5	-121.10500, 37.40936	0.02	252.19	D14	R4SB5	-121.13800, 37.39675	0.13	394.65					
D4F	R4SB5	-121.10500, 37.40843	0.02	371.39	D15	R4SB5	-121.13800, 37.39827	0.14	370.97					
D4G	R4SB5	-121.10600, 37.40714	0.05	657.82										

Source: Cowardin 1979, AECOM 2016

**DIRECTIONS:**  
Take Interstate 5 South to Fink Road  
Turn left onto Fink Road  
Turn left on Bell Road.

**DELINEATED BY:**  
T. Beyerl and P.Brillante on November 25 and December 26, 2013; and October 18, 2016.





## **APPENDIX D**

---

### Representative Photographs







Little Salado Creek at Sample Point 2 contains a patch of cattails within the channel.



View of Little Salado Creek upstream of Sample Point 2 showing the levee bank, ruderal vegetation, and adjacent agricultural fields.



Little Salado Creek at Sample Point 6.



Small basin (BN1) excavated within the channel of Little Salado Creek.



Little Salado Creek is culverted under the runway.



Typical ditch found beside the runways on the project site; Sample Point 10.



Narrow runoff ditch running beside a road leading from the former Naval support facilities to the main runway; Sample Point 11.



The understory of the willow scrub wetland is covered by heavy leaf litter and woody debris; Sample Point 4.



Wetland soil in the willow scrub wetland habitat is characterized by a redox dark surface. This soil has a very dark grayish brown (10 YR 3/2) top layer 6 inches thick with 5 percent prominent redox concentrations occurring as soft masses and pore linings.



Characteristic upland soils on the project site are dark brown (10 YR 3/3) with relict redox concentrations that are extremely firm and have abrupt boundaries. This soil is from Sample Point 5 in the saltbush scrub habitat.



Sewer treatment basin with ruderal upland vegetation at Sample Point 3.



Developed/disturbed areas include the levees on either side of Little Salado Creek and this former Navy munitions facility (top right).



Disturbed soil mounds with ruderal vegetation and an old paved road at the site of a former Naval munitions facility.



Ruderal vegetation at Sample Point 7, the site of a former firing range.



Realigned channel of Little Salado Creek (LSC4) along Fink Road east side of I-5.



Realigned channel of Little Salado Creek (LSC5) along Fink Road west side of I-5.





Vegetated agricultural ditch (D11) at intersection of Ike Crow Road and Highway 33 (sample point 12).



Agricultural ditch (D9) at intersection of Marshall Road and Highway 33 (sample point 3).



Agricultural ditch (D8) crossing Marshall Road parallel to Delta-Mendota Canal (sample point 4).



Roadside ditch (Dx) along southbound ramp onto I-5.

## **APPENDIX E**

---

### Plant Species Observed on the Project Site



<b>Appendix E: Plant Species Observed on the Crows Landing Redevelopment Project Site.</b>		
<b>Scientific Name</b>	<b>Common Name</b>	<b>Indicator Status<sup>1</sup></b>
<i>Acacia longifolia</i>	Golden wattle	NL
<i>Amaranthus albus</i>	Pigweed amaranth	FACU
<i>Amsinckia intermedia</i>	Common fiddleneck	NL
<i>Asclepias fascicularis</i>	Narrow-leaf milkweed	FAC
<i>Atriplex lentiformis</i>	Big saltbush	FAC
<i>Avena sativa</i>	Common oat	UPL
<i>Bidens frondosa</i>	Devil's beggartick	FACW
<i>Brassica nigra</i>	Black mustard	NL
<i>Bromus diandrus</i>	Ripgut brome	NL
<i>Bromus hordeaceus</i>	Soft chess	FACU
<i>Bromus madritensis</i>	Red brome	UPL
<i>Carduus pycnocephalus</i>	Italian thistle	NL
<i>Cedrus deodara</i>	Deodar cedar	NL
<i>Centaurea solstitialis</i>	Yellow star thistle	NL
<i>Conium maculatum</i>	Poison hemlock	FAC
<i>Convolvulus arvensis</i>	Field bindweed	NL
<i>Cynodon dactylon</i>	Bermuda grass	FACU
<i>Cyperus eragrostis</i>	Tall flatsedge	FACW
<i>Distichlis spicata</i>	Saltgrass	FAC
<i>Echinochloa crus-galli</i>	Barnyard grass	FAC
<i>Elaeagnus angustifolia</i>	Russian olive	FAC
<i>Epilobium brachycarpum</i>	Annual fireweed	FAC
<i>Epilobium ciliatum</i>	Fringed Willowherb	FACW
<i>Erigeron bonariensis</i>	Asthmaweed	FACU
<i>Erodium cicutarium</i>	Redstem filaree	NL
<i>Festuca arundinacea</i>	Tall fescue	FACU
<i>Festuca myuros</i>	Rattail sixweeks fescue	FACU
<i>Festuca perennis</i>	Italian ryegrass	NL
<i>Grindelia camporum</i>	Common gumplant	FACW
<i>Helianthus annuus</i>	Common sunflower	FACU
<i>Helminthotheca echioides</i>	Bristly ox-tongue	FACU
<i>Hordeum murinum</i>	Wall barley	FACU
<i>Juniperus sp.</i>	Juniper	NL
<i>Ligustrum vulgare</i>	European privet	UPL
<i>Leptochloa fusca ssp. fascicularis</i>	Bearded sprangletop	NL
<i>Malva neglecta</i>	Common mallow	NL
<i>Medicago sativa</i>	Alfalfa	UPL
<i>Medicago polymorpha</i>	Bur clover	FACU
<i>Melilotus indicus</i>	Yellow sweetclover	FACU
<i>Morus alba</i>	White mulberry	FACU
<i>Persicaria punctata</i>	Dotted smartweed	OBL

**Appendix E: Plant Species Observed on the Crows Landing Redevelopment Project Site.**

<b>Scientific Name</b>	<b>Common Name</b>	<b>Indicator Status<sup>1</sup></b>
<i>Photinia</i> sp.	Photinia	NL
<i>Plantago lanceolata</i>	English Plantain	FAC
<i>Poa pratensis</i>	Kentucky bluegrass	FAC
<i>Populus fremontii</i> ssp. <i>fremontii</i>	Fremont cottonwood	NL
<i>Pyracantha anfastifolia</i>	Firethorn	NL
<i>Rosa</i> cultivar	Domestic rose	NL
<i>Rubus armeniacus</i>	Himalayan blackberry	FACU
<i>Rumex crispus</i>	Curly dock	FAC
<i>Rumex pulcher</i>	Fiddle dock	FAC
<i>Salix exigua</i>	Narrow-leaf willow	FACW
<i>Salix gooddingii</i>	Goodding's black willow	FACW
<i>Salsola tragus</i>	Russian thistle	FACU
<i>Sorghum halepense</i>	Johnsongrass	FACU
<i>Silybum marianum</i>	Blessed milk thistle	NL
<i>Typha latifolia</i>	Broad-leaved cattail	OBL
<i>Vicia villosa</i>	Hairy vetch	NL
<i>Xanthium strumarium</i>	Rough cocklebur	FAC

<sup>1</sup> OBL= obligate wetland; FACW=facultative wetland; FAC=facultative; FACU=facultative upland; UPL= upland; NL=not listed.

Sources: species observed: AECOM 2013 and 2016; indicator status: Lichvar and Kartesz 2016

# **APPENDIX F**

---

Aquatic Resource Excel Sheet





Waters_Name	State	Cowardin_Code	HGM_Code	Meas_Type	Amount	Units	Waters_Type	Latitude	Longitude
LSC1	CALIFORNIA	R4SB5	RIVERINE	Linear	4495.31	FOOT	RPW	37.43044000	-121.10200000
LSC2	CALIFORNIA	R4SB7	RIVERINE	Linear	5368.41	FOOT	RPW	37.41860000	-121.10800000
LSC3	CALIFORNIA	R4SB7	RIVERINE	Linear	2147.35	FOOT	RPW	37.40881000	-121.11600000
LSC4	CALIFORNIA	R4SB5	RIVERINE	Linear	32.11	FOOT	RPW	37.40156000	-121.12100000
LSC5	CALIFORNIA	R4SB7	RIVERINE	Linear	210.51	FOOT	RPW	37.39775000	-121.13800000
LSC6	CALIFORNIA	R4SB7	RIVERINE	Linear	212.49	FOOT	RPW	37.39738000	-121.13900000
D1	CALIFORNIA	R6	RIVERINE	Linear	799.71	FOOT	NRPW	37.43260000	-121.10100000
D2	CALIFORNIA	R6	RIVERINE	Linear	104.99	FOOT	NRPW	37.42532000	-121.10700000
D3	CALIFORNIA	R6	RIVERINE	Linear	90.6	FOOT	NRPW	37.42496000	-121.10700000
D4A	CALIFORNIA	R6	RIVERINE	Linear	2955.07	FOOT	NRPW	37.42184000	-121.10500000
D4B	CALIFORNIA	R6	RIVERINE	Linear	1648.76	FOOT	NRPW	37.41573000	-121.10500000
D4C	CALIFORNIA	R6	RIVERINE	Linear	754.87	FOOT	NRPW	37.41240000	-121.10500000
D4D	CALIFORNIA	R6	RIVERINE	Linear	517.31	FOOT	NRPW	37.41055000	-121.10500000
D4E	CALIFORNIA	R6	RIVERINE	Linear	252.19	FOOT	NRPW	37.40936000	-121.10500000
D4F	CALIFORNIA	R6	RIVERINE	Linear	371.39	FOOT	NRPW	37.40843000	-121.10500000
D4G	CALIFORNIA	R6	RIVERINE	Linear	657.82	FOOT	NRPW	37.40714000	-121.10600000
D5	CALIFORNIA	R6	RIVERINE	Linear	2327.54	FOOT	NRPW	37.41207000	-121.11000000
D6	CALIFORNIA	R6	RIVERINE	Linear	4306.24	FOOT	NRPW	37.40331000	-121.10700000
D7	CALIFORNIA	R6	RIVERINE	Linear	125.5	FOOT	NRPW	37.42562000	-121.10700000
D8	CALIFORNIA	R4SB5	RIVERINE	Linear	52.19	FOOT	NRPW	37.43552000	-121.13400000
D9	CALIFORNIA	R4SB5	RIVERINE	Linear	57.23	FOOT	NRPW	37.43551000	-121.13400000
D10	CALIFORNIA	R4SB7	RIVERINE	Linear	61.38	FOOT	NRPW	37.43534000	-121.10200000
D11	CALIFORNIA	R4SB7	RIVERINE	Linear	250	FOOT	NRPW	37.40587000	-121.09100000
D12	CALIFORNIA	R4SB7	RIVERINE	Linear	55.94	FOOT	NRPW	37.40609000	-121.08100000
D13	CALIFORNIA	R4SB7	RIVERINE	Linear	67.93	FOOT	NRPW	37.40572000	-121.10500000
D14	CALIFORNIA	R6	RIVERINE	Linear	394.65	FOOT	NRPW	37.39674538	-121.1384959
D15	CALIFORNIA	R6	RIVERINE	Linear	370.97	FOOT	NRPW	37.39826606	-121.1381987
BN1	CALIFORNIA		DEPRESS	Area	0.02	ACRE	IMPNDMNT	37.41249816	-121.1128184
BN2	CALIFORNIA		DEPRESS	Area	0.03	ACRE	IMPNDMNT	37.41236116	-121.1125613
WS1	CALIFORNIA	PSS1	DEPRESS	Area	1.01	ACRE	RPWWN	37.42769900	-121.10127100

**Notes for Aquatic Resource Excel Sheet**

Waters_Type	Description
DELINEATE	Delineation Only - PJD or No JD Required
IMPNDMNT	Impoundments
ISOLATE	Isolated (interstate or intrastate) waters, including isolated wetlands
NRPW	Non-RPWs that flow directly or indirectly into TNWs
NRPWW	Wetlands adjacent to non-RPWs that flow directly or indirectly into TNWs
RPW	Relatively Permanent Waters (RPWs) that flow directly or indirectly into TNWs
RPWWD	Wetlands directly abutting RPWs that flow directly or indirectly into TNWs
RPWWN	Wetlands adjacent to but not directly abutting RPWs that flow directly or indirectly into TNWs
TNW	TNWs, including territorial seas
TNWRPW	Tributary consisting of both RPWs and non-RPWs
TNWW	Wetlands adjacent to TNWs
UPLAND	Uplands

HGM_Code	Name	Description
DEPRESS	Depressional	Depressional is characterized by a water source consisting of return flow from groundwater and interflow with primarily vertical hydrodynamics.
ESTUARINEF	Estuarine Fringed	The water source of the estuarine fringe consists of overbank flow from estuaries, with bidirectional and horizontal hydrodynamics being dominant.
LACUSTRINF	Lacustrine Fringe	A Lacustrine fringe has a dominant water source of lake overbank flow, and the dominant hydrodynamics are bidirectional and horizontal.
MINSOILFLT	Mineral Soil Flats	Mineral soil flats have a water source of precipitation, and vertical hydrodynamics are dominant.
ORGSOILFLT	Organic Soil Flats	Organic soil flats have precipitation as the water source, and its dominant hydrodynamic is vertical.
RIVERINE	Riverine	Riverine is characterized by a water source of overbank flow from a channel, and hydrodynamics which are predominantly unidirectional and horizontal.
SLOPE	Slope	The Slope wetland class is characterized by a water source of return flow from groundwater, with principally unidirectional and horizontal hydrodynamics.

Notes for Aquatic Resource Excel Sheet

Cowardin_Code	Category	Description	Name
E	Estuarine	Estuarine - Consists of deepwater tidal habitats and adjacent tidal wetlands that are usually semienclosed by land but have open, partly obstructed, or sporadic access to the open ocean, and in which ocean water is at least occasionally diluted by freshwater runoff from the land. The salinity may be periodically increased above that of the open ocean by evaporation. Along some low-energy coastlines there is appreciable dilution of sea water. Offshore areas with typical estuarine plants and animals, such as red mangroves and eastern oysters, are also included in the Estuarine System.	E-ESTUARINE
E1	Estuarine	Subtidal, Estuarine	E1-ESTUARINE, SUBTIDAL
E1AB	Estuarine	Aquatic Bed, Estuarine	E1AB-ESTUARINE, SUBTIDAL, AQUATIC BED
E1AB1	Estuarine	Algal, Aquatic Bed, Subtidal, Estuarine	E1AB1-ESTUARINE, SUBTIDAL, AQUATIC BED, ALGAL
E1AB3	Estuarine	Rooted Vascular, Aquatic Bed, Subtidal, Estuarine	E1AB3-ESTUARINE, SUBTIDAL, AQUA BED, ROOT VASC
E1AB4	Estuarine	Floating Vascular, Aquatic Bed, Subtidal, Estuarine	E1AB4-ESTUARINE, SUBTIDAL, AQUA BED, FLOT VASC
E1AB5	Estuarine	Unknown Submergent, Aquatic Bed, Subtidal, Estuarine	E1AB5-ESTUARINE, SUBTIDAL, AQUA BED, UNK SUB
E1AB6	Estuarine	Unknown Surface, Aquatic Bed, Subtidal, Estuarine	E1AB6-ESTUARINE, SUBTIDAL, AQUA BED, UNK SUR
E1OW	Estuarine	Open Water, Subtidal, Estuarine (used on older maps)	E1OW-ESTUARINE, SUBTIDAL, OPEN WATER
E1RB	Estuarine	Rock Bottom, Subtidal, Estuarine	E1RB-ESTUARINE, SUBTIDAL, ROCK BOTTOM
E1RB1	Estuarine	Bedrock, Rock Bottom, Subtidal, Estuarine	E1RB1-ESTUARINE, SUBTIDAL, ROCK BOTTOM, BEDROK
E1RB2	Estuarine	Rubble, Rock Bottom, Subtidal, Estuarine	E1RB2-ESTUARINE, SUBTIDAL, ROCK BOTTOM, RUBBLE
E1RF	Estuarine	Reef, Subtidal, Estuarine	E1RF-ESTUARINE, SUBTIDAL, REEF
E1RF2	Estuarine	Mollusc, Reef, Subtidal, Estuarine	E1RF2-ESTUARINE, SUBTIDAL, REEF, MOLLUSC
E1RF3	Estuarine	Worm, Reef, Subtidal, Estuarine	E1RF3-ESTUARINE, SUBTIDAL, REEF, WORM
E1UB	Estuarine	Unconsolidated Bottom, Subtidal, Estuarine	E1UB-ESTUARINE, SUBTIDAL UNCONSOLIDATED BOTTM
E1UB1	Estuarine	Cobble-Gravel, Unconsolidated Bottom, Subtidal, Estuarine	E1UB1-ESTUARINE, SUBTIDAL, UNCONSOL BOTOM, COB
E1UB2	Estuarine	Sand, Unconsolidated Bottom, Subtidal, Estuarine	E1UB2-ESTUARINE, SUBTIDAL, UNCONSOL BOT, SAND
E1UB3	Estuarine	Mud, Unconsolidated Bottom, Subtidal, Estuarine	E1UB3-ESTUARINE, SUBTIDAL, UNCONSOL BOT, MUD
E1UB4	Estuarine	Organic, Unconsolidated Bottom, Subtidal, Estuarine	E1UB4-ESTUARINE, SUBTIDAL, UNCONSOL BOT, ORG
E2	Estuarine	Intertidal, Estuarine	E2-ESTUARINE, INTERTIDAL
E2AB	Estuarine	Aquatic Bed, Intertidal, Estuarine	E2AB-ESTUARINE, INTERTIDAL, AQUATIC BED
E2AB1	Estuarine	Algal, Aquatic, Bed, Intertidal, Estuarine	E2AB1-ESTUARINE, INTERTIDAL, AQUA BED, ALGAL
E2AB3	Estuarine	Rooted Vascular, Aquatic Bed, Intertidal, Estuarine	E2AB3-ESTUARINE, INTERTIDAL, AQUA BED, ROOT VA
E2AB4	Estuarine	Floating Vascular, Aquatic Bed, Intertidal, Estuarine	E2AB4-ESTUARINE, INTERTIDAL, AQUABED, FLOAT VA
E2AB5	Estuarine	Unknown Submergent, Aquatic Bed, Intertidal, Estuarine	E2AB5-ESTUARINE, INTERTIDAL, AQUABED, UNK SUB
E2AB6	Estuarine	Unknown Surface, Aquatic Bed, Intertidal, Estuarine	E2AB6-ESTUARINE, INTERTIDAL, AQUABED, UNK SUR
E2EM	Estuarine	Emergent, Intertidal, Estuarine	E2EM-ESTUARINE, INTERTIDAL, EMERGENT
E2EM1	Estuarine	Persistent, Emergent, Intertidal, Estuarine	E2EM1-ESTUARINE, INTERTIDAL, EMERGENT, PERSIST
E2EM2	Estuarine	Nonpersistent, Emergent, Intertidal, Estuarine	E2EM2-ESTUARINE, INTERTIDAL, EMERGENT, NONPERS
E2FO	Estuarine	Forested, Intertidal, Estuarine	E2FO-ESTUARINE, INTERTIDAL, FORESTED
E2FO1	Estuarine	Broad-Leaved Deciduous, Forested, Intertidal, Estuarine	E2FO1-ESTUARINE, INTERTIDAL, FORESTED, BLD
E2FO2	Estuarine	Needle-Leaved Deciduous, Forested, Intertidal, Estuarine	E2FO2-ESTUARINE, INTERTIDAL, FORESTED, NLD
E2FO3	Estuarine	Broad-Leaved Evergreen, Forested, Intertidal, Estuarine	E2FO3-ESTUARINE, INTERTIDAL, FORESTED, BLE
E2FO4	Estuarine	Needle-Leaved Evergreen, Forested, Intertidal, Estuarine	E2FO4-ESTUARINE, INTERTIDAL, FORESTED, NLE
E2FO5	Estuarine	Dead, Forested, Intertidal, Estuarine	E2FO5-ESTUARINE, INTERTIDAL, FORESTED, DEAD
E2FO6	Estuarine	Indeterminate Deciduous, Forested, Intertidal, Estuarine	E2FO6-ESTUARINE, INTERTIDAL, FORESTED, IND
E2FO7	Estuarine	Indeterminate Evergreen, Forested, Intertidal, Estuarine	E2FO7-ESTUARINE, INTERTIDAL, FORESTED, INE
E2RF	Estuarine	Reef, Intertidal, Estuarine	E2RF-ESTUARINE, INTERTIDAL, REEF
E2RF2	Estuarine	Mollusc, Reef, Intertidal, Estuarine	E2RF2-ESTUARINE, INTERTIDAL, REEF, MOLLUSC
E2RF3	Estuarine	Worm, Reef, Intertidal, Estuarine	E2RF3-ESTUARINE, INTERTIDAL, REEF, WORM
E2RS	Estuarine	Rocky Shore, Intertidal, Estuarine	E2RS-ESTUARINE, INTERTIDAL, ROCKY SHORE
E2RS1	Estuarine	Bedrock, Rocky Shore, Intertidal, Estuarine	E2RS1-ESTUARINE, INTERTIDAL, ROCK SHR, BEDROK
E2RS2	Estuarine	Rubble, Rocky Shore, Intertidal, Estuarine	E2RS2-ESTUARINE, INTERTIDAL, ROCK SHR, RUBBLE
E2SB	Estuarine	Stream Bed, Intertidal, Estuarine	E2SB-ESTUARINE, INTERTIDAL, STREAM BED
E2SB3	Estuarine	Cobble-Gravel, Stream Bed, Intertidal, Estuarine	E2SB3-ESTUARINE, INTERTIDAL, STREAM BED, COBBL
E2SB4	Estuarine	Sand, Stream Bed, Intertidal, Estuarine	E2SB4-ESTUARINE, INTERTIDAL, STREAM BED, SAND
E2SB5	Estuarine	Mud, Stream Bed, Intertidal, Estuarine	E2SB5-ESTUARINE, INTERTIDAL, STREAM BED, MUD
E2SB6	Estuarine	Organic, Stream Bed, Intertidal, Estuarine	E2SB6-ESTUARINE, INTERTIDAL, STREAM BED, ORGAN
E2SS	Estuarine	Scrub-Shrub, Intertidal, Estuarine	E2SS-ESTUARINE, INTERTIDAL, SCRUB-SHRUB
E2SS1	Estuarine	Broad-Leaved Deciduous, Scrub-Shrub, Intertidal, Estuarine	E2SS1-ESTUARINE, INTERTIDAL, SCRUB-SHRUB, BLD
E2SS2	Estuarine	Needle-Leaved Deciduous, Scrub-Shrub, Intertidal, Estuarine	E2SS2-ESTUARINE, INTERTIDAL, SCRUB-SHRUB, NLD
E2SS3	Estuarine	Broad-Leaved Evergreen, Scrub-Shrub, Intertidal, Estuarine	E2SS3-ESTUARINE, INTERTIDAL, SCRUB-SHRUB, BLE
E2SS4	Estuarine	Needle-Leaved Evergreen, Scrub-Shrub, Intertidal, Estuarine	E2SS4-ESTUARINE, INTERTIDAL, SCRUB-SHRUB, NLE
E2SS5	Estuarine	Dead, Scrub-Shrub, Intertidal, Estuarine	E2SS5-ESTUARINE, INTERTIDAL, SCRUB-SHRUB, DEAD

Notes for Aquatic Resource Excel Sheet

E2SS6	Estuarine	Indeterminate Deciduous, Scrub-Shrub, Intertidal, Estuarine	E2SS6-ESTUARINE, INTERTIDAL, SCRUB-SHRUB, IND
E2SS7	Estuarine	Indeterminate Evergreen, Scrub-Shrub, Intertidal, Estuarine	E2SS7-ESTUARINE, INTERTIDAL, SCRUB-SHRUB, INE
E2US	Estuarine	Unconsolidated Shore, Intertidal, Estuarine	E2US-ESTUARINE, INTERTIDAL, UNCONSOL SHORE
E2US1	Estuarine	Cobble, Unconsolidated Shore, Intertidal, Estuarine	E2US1-ESTUARINE, INTERTIDAL, UNCONSOL SHR, COB
E2US2	Estuarine	Sand, Unconsolidated Shore, Intertidal, Estuarine	E2US2-ESTUARINE, INTERTIDAL, UNCONSOL SHR, SAN
E2US3	Estuarine	Mud, Unconsolidated Shore, Intertidal, Estuarine	E2US3-ESTUARINE, INTERTIDAL, UNCONSOL BOT, MUD
E2US4	Estuarine	Organic, Unconsolidated Shore, Intertidal, Estuarine	E2US4-ESTUARINE, INTERTIDAL, UNCONSOL SHR, ORG
L	Lacustrine	Lacustrine - Includes wetlands and deepwater habitats with all of the following characteristics: (1) situated in a topographic depression or a dammed river channel; (2) lacking trees, shrubs, persistent emergents, emergent mosses or lichens with greater than 30% areal coverage; and (3) total area exceeds 8 ha (20 acres). Similar wetland and deepwater habitats totaling less than 8 ha are also included in the Lacustrine System if an active wave-formed or bedrock shoreline feature makes up all or part of the boundary, or if the water depth in the deepest part of the basin exceeds 2 m (6.6 feet) at low water. Lacustrine waters may be tidal or nontidal, but ocean-derived salinity is always less than 0.5%.	L-LACUSTRINE
L1	Lacustrine	Lacustrine - Includes wetlands and deepwater habitats with all of the following characteristics: (1) situated in a topographic depression or a dammed river channel; (2) lacking trees, shrubs, persistent emergents, emergent mosses or lichens with greater than 30% areal coverage; and (3) total area exceeds 8 ha (20 acres). Similar wetland and deepwater habitats totaling less than 8 ha are also included in the Lacustrine System if an active wave-formed or bedrock shoreline feature makes up all or part of the boundary, or if the water depth in the deepest part of the basin exceeds 2 m (6.6 feet) at low water. Lacustrine waters may be tidal or nontidal, but ocean-derived salinity is always less than 0.5%.	L1-LACUSTRINE, LIMNETIC
L1AB	Lacustrine	Aquatic Bed, Limnetic, Lacustrine	L1AB-LACUSTRINE, LIMNETIC, AQUA BED
L1AB1	Lacustrine	Algal, Aquatic Bed, Limnetic, Lacustrine	L1AB1-LACUSTRINE, LIMNETIC, AQUA BED, ALGAL
L1AB2	Lacustrine	Aquatic Moss, Aquatic Bed, Limnetic, Lacustrine	L1AB2-LACUSTRINE, LIMNETIC, AQUA BED, AQUA MOS
L1AB3	Lacustrine	Rooted Vascular, Aquatic Bed, Limnetic, Lacustrine	L1AB3-LACUSTRINE, LIMNETIC, AQUA BED, ROOT VAS
L1AB4	Lacustrine	Floating Vascular, Aquatic Bed, Limnetic, Lacustrine	L1AB4-LACUSTRINE, LIMNETIC, AQUA BED, FLOT VAS
L1AB5	Lacustrine	Unknown Submergent, Aquatic Bed, Limnetic, Lacustrine	L1AB5-LACUSTRINE, LIMNETIC, AQUA BED, UNK SUB
L1AB6	Lacustrine	Unknown Surface, Aquatic Bed, Limnetic, Lacustrine	L1AB6-LACUSTRINE, LIMNETIC, AQUA BED, UNK SURF
L1OW	Lacustrine	Open Water/Unknown Bottom, Limnetic, Lacustrine (used on older maps)	L1OW-LACUSTRINE, LIMNETIC, OPEN WATER/UNK BOT
L1RB	Lacustrine	Rock Bottom, Limnetic, Lacustrine	L1RB-LACUSTRINE, LIMNETIC, ROCK BOTTOM
L1RB1	Lacustrine	Bedrock, Rock Bottom, Limnetic, Lacustrine	L1RB1-LACUSTRINE, LIMNETIC, ROCK BOT, BEDROCK
L1RB2	Lacustrine	Rubble, Rock Bottom, Limnetic, Lacustrine	L1RB2-LACUSTRINE, LIMNETIC, ROCK BOT, RUBBLE
L1UB	Lacustrine	Unconsolidated Bottom, Limnetic, Lacustrine	L1UB-LACUSTRINE, LIMNETIC, UNCONSOL BOTTOM
L1UB1	Lacustrine	Cobble-Gravel, Unconsolidated Bottom, Limnetic, Lacustrine	L1UB1-LACUSTRINE, LIMNETIC, UNCONSOL BOT, COGGLE
L1UB2	Lacustrine	Sand, Unconsolidated Bottom, Limnetic, Lacustrine	L1UB2-LACUSTRINE, LIMNETIC, UNCONSOL BOT, SAND
L1UB3	Lacustrine	Mud, Unconsolidated Bottom, Limnetic, Lacustrine	L1UB3-LACUSTRINE, LIMNETIC, UNCONSOL BOT, MUD
L1UB4	Lacustrine	Organic, Unconsolidated Bottom, Limnetic, Lacustrine	L1UB4-LACUSTRINE, LIMNETIC, UNCONSOL BOT, ORGANI
L2	Lacustrine	Littoral, Lacustrine	L2-LACUSTRINE, LITTORAL
L2AB	Lacustrine	Aquatic Bed, Littoral, Lacustrine	L2AB-LACUSTRINE, LITTORAL, AQUA BED
L2AB1	Lacustrine	Algal, Aquatic Bed, Littoral, Lacustrine	L2AB1-LACUSTRINE, LITTORAL, AQUA BED, ALGAL
L2AB2	Lacustrine	Aquatic Moss, Aquatic Bed, Littoral, Lacustrine	L2AB2-LACUSTRINE, LITTORAL, AQUA BED, AQUA MOS
L2AB3	Lacustrine	Rooted Vascular, Aquatic Bed, Littoral, Lacustrine	L2AB3-LACUSTRINE, LITTORAL, AQUA BED, ROOT VAS
L2AB4	Lacustrine	Floating Vascular, Aquatic Bed, Littoral, Lacustrine	L2AB4-LACUSTRINE, LITTORAL, AQUA BED, FLOT VAS
L2AB5	Lacustrine	Unknown Submergent, Aquatic Bed, Littoral, Lacustrine	L2AB5-LACUSTRINE, LITTORAL, AQUA BED, UNK SUB
L2AB6	Lacustrine	Unknown Surface, Aquatic Bed, Littoral, Lacustrine	L2AB6-LACUSTRINE, LITTORAL, AQUA BED, UNK SURF
L2EM	Lacustrine	Emergent, Littoral, Lacustrine	L2EM-LACUSTRINE, LITTORAL, EMERGENT
L2EM2	Lacustrine	Nonpersistent, Emergent, Littoral, Lacustrine	L2EM2-LACUSTRINE, LITTORAL, EMERGENT, NONPERS
L2OW	Lacustrine	Open Water/Unknown Bottom, Littoral, Lacustrine	L2OW-LACUSTRINE, LITTORAL, OPEN WATER
L2RB	Lacustrine	Rock Bottom, Littoral, Lacustrine	L2RB-LACUSTRINE, LITTORAL, ROCK BOTTOM
L2RB1	Lacustrine	Bedrock, Rock Bottom, Littoral, Lacustrine	L2RB1-LACUSTRINE, LITTORAL, ROCK BOT, BEDROCK
L2RB2	Lacustrine	Rubble, Rock Bottom, Littoral, Lacustrine	L2RB2-LACUSTRINE, LITTORAL, ROCK BOT, RUBBLE
L2RS	Lacustrine	Rocky Shore, Littoral, Lacustrine	L2RS-LACUSTRINE, LITTORAL, ROCKY SHORE
L2RS1	Lacustrine	Bedrock, Rocky Shore, Littoral, Lacustrine	L2RS1-LACUSTRINE, LITTORAL, ROCKY SHR, BEDROCK
L2RS2	Lacustrine	Rubble, Rocky Shore, Littoral, Lacustrine	L2RS2-LACUSTRINE, LITTORAL, ROCKY SHR, RUBBLE
L2UB	Lacustrine	Unconsolidated Bottom, Littoral, Lacustrine	L2UB-LACUSTRINE, LITTORAL, UNCONSOL BOT
L2UB1	Lacustrine	Cobble-Gravel, Unconsolidated Bottom, Littoral, Lacustrine	L2UB1-LACUSTRINE, LITTORAL, UNCONSOL BOT, COBBLE
L2UB2	Lacustrine	Sand, Unconsolidated Bottom, Littoral, Lacustrine	L2UB2-LACUSTRINE, LITTORAL, UNCONSOL BOT, SAND
L2UB3	Lacustrine	Mud, Unconsolidated Bottom, Littoral, Lacustrine	L2UB3-LACUSTRINE, LITTORAL, UNCONSOL BOT, MUD
L2UB4	Lacustrine	Organic, Unconsolidated Bottom, Littoral, Lacustrine	L2UB4-LACUSTRINE, LITTORAL, UNCONSOL BOT, ORGAN
L2US	Lacustrine	Unconsolidated Shore, Littoral, Lacustrine	L2US-LACUSTRINE, LITTORAL, UNCONSOL SHORE
L2US1	Lacustrine	Cobble-Gravel, Unconsolidated Shore, Littoral, Lacustrine	L2US1-LACUSTRINE, LITTORAL, UNCONSOL SHR, COBBLE
L2US2	Lacustrine	Sand, Unconsolidated Shore, Littoral, Lacustrine	L2US2-LACUSTRINE, LITTORAL, UNCONSOL SHR, SAND
L2US3	Lacustrine	Mud, Unconsolidated Shore, Littoral, Lacustrine	L2US3-LACUSTRINE, LITTORAL, UNCONSOL SHR, MUD

Notes for Aquatic Resource Excel Sheet

L2US4	Lacustrine	Organic, Unconsolidated Shore, Littoral, Lacustrine	L2US4-LACUSTRINE, LITTORAL, UNCONSOL SHR, ORGAN
L2US5	Lacustrine	Vegetated, Unconsolidated Shore, Littoral, Lacustrine	L2US5-LACUSTRINE, LITTORAL, UNCONSOL SHR, VEGET
M	Marine	Marine - Consists of the open ocean overlying the continental shelf and its associated high-energy coastline. Marine habitats are exposed to the waves and currents of the open ocean and the water regimes are determined primarily by the ebb and flow of oceanic tides. Salinities exceed 30‰ with little or no dilution except outside the mouths of estuaries. Shallow coastal indentations or bays without appreciable freshwater inflow, and coasts with exposed rocky islands that provide the mainland with little or no shelter from wind and waves, are also considered part of the Marine System because they generally support typical marine biota.	M-MARINE
M1	Marine	Subtidal Marine	M1-MARINE, SUBTIDAL
M1AB	Marine	Aquatic Bed, Subtidal, Marine	M1AB-MARINE, SUBTIDAL, AQUATIC BED
M1AB1	Marine	Algal, Aquatic Bed, Subtidal, Marine	M1AB1-MARINE, SUBTIDAL, AQUATIC BED, ALGAL
M1AB3	Marine	Rooted Vascular, Aquatic Bed, Subtidal, Marine	M1AB3-MARINE, SUBTIDAL, AQUATIC BED, ROOT VASC
M1AB5	Marine	Unknown Submergent, Aquatic Bed, Subtidal, Marine	M1AB5-MARINE, SUBTIDAL, AQUATIC BED, UNK SUB
M1OW	Marine	Open Water, Subtidal, Marine (Used on older maps)	M1OW-MARINE, SUBTIDAL, OPEN WATER
M1RB	Marine	Rock Bottom Subtidal Marine	M1RB-MARINE, SUBTIDAL, ROCK BOTTOM
M1RB1	Marine	Bedrock, Rock Bottom, Subtidal, Marine	M1RB1-MARINE, SUBTIDAL, ROCK BOTTOM, BEDROCK
M1RB2	Marine	Rubble, Rock Bottom, Subtidal, Marine	M1RB2-MARINE, SUBTIDAL, ROCK BOTTOM, RUBBLE
M1RF	Marine	Nonpersistent, Emergent, Lower Perennial, Riverine	M1RF-MARINE, SUBTIDAL, REEF
M1RF1	Marine	Coral, Reef, Subtidal, Marine	M1RF1-MARINE, SUBTIDAL, REEF, CORAL
M1RF3	Marine	Worm, Reef, Subtidal, Marine	M1RF3-MARINE, SUBTIDAL, REEF, WORM
M1UB	Marine	Unconsolidated Bottom, Subtidal, Marine	M1UB-MARINE, SUBTIDAL, UNCONSOLIDATED BOTTOM
M1UB1	Marine	Cobble-Gravel, Unconsolidated, Subtidal, Marine	M1UB1-MARINE, SUBTIDAL, UNCONSOL BOTTOM, COBBL
M1UB2	Marine	Sand, Unconsolidated Bottom, Subtidal, Marine	M1UB2-MARINE, SUBTIDAL, UNCONSOL BOTTOM, SAND
M1UB3	Marine	Mud, Unconsolidated Bottom, Subtidal, Marine	M1UB3-MARINE, SUBTIDAL, UNCONSOL BOTTOM, MUD
M1UB4	Marine	Organic, Unconsolidated Bottom, Subtidal, Marine	M1UB4-MARINE, SUBTIDAL, UNCONSOL BOTTOM, ORGAN
M2	Marine	Intertidal, Marine	M2-MARINE, INTERTIDAL
M2AB	Marine	Aquatic Bed, Intertidal, Marine	M2AB-MARINE, INTERTIDAL, AQUATIC BED
M2AB1	Marine	Algal, Aquatic Bed, Intertidal, Marine	M2AB1-MARINE, INTERTIDAL, AQUATIC BED, ALGAL
M2AB3	Marine	Rooted Vascular, Aquatic Bed, Intertidal, Marine	M2AB3-MARINE, INTERTIDAL, AQUATIC BED, ROOT VASC
M2AB5	Marine	Unknown Submergent, Aquatic Bed, Intertidal, Marine	M2AB5-MARINE, INTERTIDAL, AQUATIC BED, UNK SUB
M2RF	Marine	Reef, Intertidal, Marine	M2RF-MARINE, INTERTIDAL, REEF
M2RF1	Marine	Coral, Reef, Intertidal, Marine	M2RF1-MARINE, INTERTIDAL, REEF, CORAL
M2RF3	Marine	Worm, Reef, Intertidal, Marine	M2RF3-MARINE, INTERTIDAL, REEF, WORM
M2RS	Marine	Rocky Shore, Intertidal, Marine	M2RS-MARINE, INTERTIDAL, ROCKY SHORE
M2RS1	Marine	Bedrock, Rocky Shore, Intertidal, Marine	M2RS1-MARINE, INTERTIDAL, ROCKY SHORE, BEDROCK
M2RS2	Marine	Rubble, Rocky Shore, Intertidal, Marine	M2RS2-MARINE, INTERTIDAL, ROCKY SHORE, RUBBLE
M2US	Marine	Unconsolidated Shore, Intertidal, Marine	M2US-MARINE, INTERTIDAL, UNCONSOLIDATED SHORE
M2US1	Marine	Cobble-Gravel, Unconsolidated Shore, Intertidal, Marine	M2US1-MARINE, INTERTIDAL, UNCONSOL SHORE, COBB
M2US2	Marine	Sand, Unconsolidated Shore, Intertidal, Marine	M2US2-MARINE, INTERTIDAL, UNCONSOL SHORE, SAND
M2US3	Marine	Mud, Unconsolidated Shore, Intertidal, Marine	M2US3-MARINE, INTERTIDAL, UNCONSOL SHORE, MUD
M2US4	Marine	Organic, Unconsolidated Shore, Intertidal, Marine	M2US4-MARINE, INTERTIDAL, UNCONSOL SHORE, ORG
P	Palustrine	Palustrine - Includes all nontidal wetlands dominated by trees, shrubs, persistent emergents, emergent mosses or lichens, and all such wetlands that occur in tidal areas where salinity due to ocean-derived salts is below 0.5‰. It also includes wetlands lacking such vegetation, but with all of the following characteristics: (1) area less than 8 ha (20 acres); (2) active wave-formed or bedrock shoreline features lacking; (3) water depth in the deepest part of basin less than 2 m at low water; and (4) salinity due to ocean-derived salts less than 0.5‰.	P-PALUSTRINE
PAB	Palustrine	Aquatic Bed, Palustrine	PAB-PALUSTRINE, AQUA BED
PAB1	Palustrine	Algal, Aquatic Bed, Palustrine	PAB1-PALUSTRINE, AQUA BED, ALGAL
PAB2	Palustrine	Aquatic Moss, Aquatic Bed, Palustrine	PAB2-PALUSTRINE, AQUA BED, AQUATIC MOSS
PAB3	Palustrine	Rooted Vascular, Aquatic Bed, Palustrine	PAB3-PALUSTRINE, AQUA BED, ROOTED VASC
PAB4	Palustrine	Floating Vascular, Aquatic Bed, Palustrine	PAB4-PALUSTRINE, AQUA BED, FLOAT VASC
PAB5	Palustrine	Unknown Submergent, Aquatic Bed, Palustrine	PAB5-PALUSTRINE, AQUA BED, UNK SUB
PAB6	Palustrine	Unknown Surface, Aquatic Bed, Palustrine	PAB6-PALUSTRINE, AQUA BED, UNK SURF
PEM	Palustrine	Emergent, Palustrine	PEM-PALUSTRINE, EMERGENT
PEM1	Palustrine	Persistent, Emergent, Palustrine	PEM1-PALUSTRINE, EMERGENT, PERSISTENT
PEM2	Palustrine	Nonpersistent, Emergent, Palustrine	PEM2-PALUSTRINE, EMERGENT, NONPERSISTENT
PFO	Palustrine	Forested, Palustrine	PFO-PALUSTRINE, FORESTED
PFO1	Palustrine	Broad-Leaved Deciduous, Forested, Palustrine	PFO1-PALUSTRINE, FORESTED, BLD
PFO2	Palustrine	Needle-Leaved Deciduous, Forested, Palustrine	PFO2-PALUSTRINE, FORESTED, NLE
PFO3	Palustrine	Broad-Leaved Evergreen, Forested, Palustrine	PFO3-PALUSTRINE, FORESTED, BLE
PFO4	Palustrine	Needle-Leaved Evergreen, Forested, Palustrine	PFO4-PALUSTRINE, FORESTED, NLE

Notes for Aquatic Resource Excel Sheet

PFO5	Palustrine	Dead, Forested, Palustrine	PFO5-PALUSTRINE, FORESTED, DEAD
PFO6	Palustrine	Indeterminate Deciduous, Forested, Palustrine	PFO6-PALUSTRINE, FORESTED, INDET DEC
PFO7	Palustrine	Indeterminate Evergreen, Forested, Palustrine	PFO7-PALUSTRINE, FORESTED, INDETER EVER
PML	Palustrine	Moss-Lichens, Palustrine	PML-PALUSTRINE, MOSS-LICHENS
PML1	Palustrine	Moss, Moss-Lichens, Palustrine	PML1-PALUSTRINE, MOSS-LICHENS, MOSS
PML2	Palustrine	Lichen, Moss-Lichen, Palustrine	PML2-PALUSTRINE, MOSS-LICHEN, LICHEN
POW	Palustrine	POW-PALUSTRINE, OPEN WATER	POW-PALUSTRINE, OPEN WATER
PRB	Palustrine	Rock Bottom, Palustrine	PRB-PALUSTRINE, ROCK BOTTOM
PRB1	Palustrine	Bedrock, Rock Bottom, Palustrine	PRB1-PALUSTRINE, ROCK BOTTOM, BEDROCK
PRB2	Palustrine	Rubble, Rock Bottom, Palustrine	PRB2-PALUSTRINE, ROCK BOTTOM, RUBBLE
PSS	Palustrine	Scrub-Shrub, Palustrine	PSS-PALUSTRINE, SCRUB-SHRUB
PSS1	Palustrine	Broad-Leaved Deciduous, Scrub-Shrub, Palustrine	PSS1-PALUSTRINE, SCRUB-SHRUB, BLD
PSS2	Palustrine	Needle-Leaved Deciduous, Scrub-Shrub, Palustrine	PSS2-PALUSTRINE, SCRUB-SHRUB, NLD
PSS3	Palustrine	Broad-Leaved Evergreen, Scrub-Shrub, Palustrine	PSS3-PALUSTRINE, SCRUB-SHRUB, BLE
PSS4	Palustrine	Needle-Leaved Evergreen, Scrub-Shrub, Palustrine	PSS4-PALUSTRINE, SCRUB-SHRUB, NLE
PSS5	Palustrine	Dead, Scrub-Shrub	PSS5-PALUSTRINE, SCRUB-SHRUB, DEAD
PSS6	Palustrine	Indeterminate Deciduous, Scrub-Shrub, Palustrine	PSS6-PALUSTRINE, SCRUB-SHRUB, INDET DEC
PSS7	Palustrine	Indeterminate Evergreen, Scrub-Shrub, Palustrine	PSS7-PALUSTRINE, SCRUB-SHRUB, INDET EVER
PUB	Palustrine	Unconsolidated Bottom, Palustrine	PUB-PALUSTRINE, UNCONSOL BOT
PUB1	Palustrine	Cobble-Gravel, Unconsolidated Bottom, Palustrine	PUB1-PALUSTRINE, UNCONSOL BOT, COBBLE
PUB2	Palustrine	Sand, Unconsolidated Bottom, Palustrine	PUB2-PALUSTRINE, UNCONSOL BOT, SAND
PUB3	Palustrine	Mud, Unconsolidated Bottom, Palustrine	PUB3-PALUSTRINE, UNCONSOL BOT, MUD
PUB4	Palustrine	Organic, Unconsolidated Bottom, Palustrine	PUB4-PALUSTRINE, UNCONSOL BOT, ORGANIC
RP	Riparian	Riparian - Plant communities contiguous to and affected by surface and subsurface hydrologic features of perennial or intermittent lotic and lentic water bodies (rivers, streams, lakes, or drainage ways). Riparian areas have one or both of the following characteristics: 1) distinctively different vegetative species than adjacent areas, and 2) species similar to adjacent areas but exhibiting more vigorous or robust growth forms. Riparian areas are usually transitional between wetland and upland.	RP-RIPARIAN
RP1	Riparian	Lotic, Riparian	RP1-RIPARIAN, LOTIC
RP1EM	Riparian	Emergent, Lotic, Riparian	RP1EM-RIPARIAN, LOTIC, EMERGENT
RP1FO	Riparian	Forested, Lotic, Riparian	RP1FO-RIPARIAN, LOTIC, FORESTED
RP1FO6	Riparian	Deciduous, Forested, Lotic, Riparian	RP1FO6-RIPARIAN, LOTIC, FORESTED, DECIDOUS
RP1FO7	Riparian	Evergreen, Forested, Lotic, Riparian	RP1FO7-RIPARIAN, LOTIC, FORESTED, EVERGREEN
RP1FO8	Riparian	Mixed, Forested, Lotic, Riparian	RP1FO8-RIPARIAN, LOTIC, FORESTED, MIXED
RP1SS	Riparian	Scrub-Shrub, Lotic, Riparian	RP1SS-RIPARIAN, LOTIC, SCRUB-SHRUB
RP1SS6	Riparian	Deciduous, Scrub-Shrub, Lotic, Riparian	RP1SS6-RIPARIAN, LOTIC, SCRUB-SHRUB, DECIDOUS
RP1SS7	Riparian	Evergreen, Scrub-Shrub, Lotic, Riparian	RP1SS7-RIPARIAN, LOTIC, SCRUB-SHRUB, EVERGREEN
RP1SS8	Riparian	Mixed, Scrub-Shrub, Lotic, Riparian	RP1SS8-RIPARIAN, LOTIC, SCRUB-SHRUB, MIXED
RP2	Riparian	Lentic, Riparian	RP2-RIPARIAN, LENTIC
RP2EM	Riparian	Emergent, Lentic, Riparian	RP2EM-RIPARIAN, LENTIC, EMERGENT
RP2FO	Riparian	Forested, Lentic, Riparian	RP2FO-RIPARIAN, LENTIC, FORESTED
RP2FO6	Riparian	Deciduous, Forested, Lentic, Riparian	RP2FO6-RIPARIAN, LENTIC, FORESTED, DECIDOUS
RP2FO7	Riparian	Evergreen, Forested, Lentic, Riparian	RP2FO7-RIPARIAN, LENTIC, FORESTED, EVERGREEN
RP2FO8	Riparian	Mixed, Forested, Lentic, Riparian	RP2FO8-RIPARIAN, LENTIC, FORESTED, MIXED
RP2SS	Riparian	Scrub-Shrub, Lentic, Riparian	RP2SS-RIPARIAN, LENTIC, SCRUB-SHRUB
RP2SS6	Riparian	Deciduous, Scrub-Shrub, Lentic, Riparian	RP2SS6-RIPARIAN, LENTIC, SCRUB-SHRUB, DECIDOUS
RP2SS7	Riparian	Evergreen, Scrub-Shrub, Lentic, Riparian	RP2SS7-RIPARIAN, LENTIC, SCRUB-SHRUB, EVERGREEN
RP2SS8	Riparian	Mixed, Scrub-Shrub, Lentic, Riparian	RP2SS8-RIPARIAN, LENTIC, SCRUB-SHRUB, MIXED
R	Riverine	Riverine - Includes all wetlands and deepwater habitats contained within a channel, with two exceptions: (1) wetlands dominated by trees, shrubs, persistent emergents, emergent mosses, or lichens, and (2) habitats with water containing ocean-derived salts in excess of 0.5%.	R-RIVERINE
R1	Riverine	Tidal, Riverine	R1-RIVERINE, TIDAL
R1AB	Riverine	Aquatic Bed, Tidal, Riverine	R1AB-RIVERINE, TIDAL, AQUATIC BED
R1AB1	Riverine	Algal, Aquatic Bed, Tidal, Riverine	R1AB1-RIVERINE, TIDAL, AQUATIC BED, ALGAL
R1AB2	Riverine	Aquatic Moss, Aquatic Bed, Tidal, Riverine	R1AB2-RIVERINE, TIDAL, AQUA BED, MOSS
R1AB3	Riverine	Rooted Vascular, Aquatic Bed, Tidal, Riverine	R1AB3-RIVERINE, TIDAL, AQUA BED, ROOTED VASC
R1AB4	Riverine	Floating Vascular, Aquatic Bed, Tidal, Riverine	R1AB4-RIVERINE, TIDAL, AQUA BED, FLOATING VASC
R1AB5	Riverine	Unknown Submergent, Aquatic Bed, Tidal, Riverine	R1AB5-RIVERINE, TIDAL, AQUA BED, UNK SUBMERGEN
R1AB6	Riverine	Unknown Surface, Aquatic Bed, Tidal, Riverine	R1AB6-RIVERINE, TIDAL, AQUA BED, UNK SURFACE
R1EM	Riverine	Emergent, Tidal, Riverine	R1EM-RIVERINE, TIDAL, EMERGENT
R1EM2	Riverine	Nonpersistent, Emergent, Tidal, Riverine	R1EM2-RIVERINE, TIDAL, EMERGENT, NONPERSISTENT

Notes for Aquatic Resource Excel Sheet

R1RB	Riverine	Rock Bottom, Tidal, Riverine	R1RB-RIVERINE, TIDAL, ROCK BOTTOM
R1RB1	Riverine	Bedrock, Rock Bottom, Tidal, Riverine	R1RB1-RIVERINE, TIDAL, ROCK BOTTOM, BEDROCK
R1RB2	Riverine	Rubble, Rock Bottom, Tidal, Riverine	R1RB2-RIVERINE, TIDAL, ROCK BOTTOM, RUBBLE
R1RS	Riverine	Rocky Shore, Tidal, Riverine	R1RS-RIVERINE, TIDAL, ROCKY SHORE
R1RS1	Riverine	Bedrock, Rocky Shore, Tidal, Riverine	R1RS1-RIVERINE, TIDAL, ROCKY SHORE, BEDROCK
R1RS2	Riverine	Rubble, Rocky Shore, Tidal, Riverine	R1RS2-RIVERINE, TIDAL, ROCKY SHORE, RUBBLE
R1SB	Riverine	Streambed, Tidal, Riverine	R1SB-RIVERINE, TIDAL, STREAMBED
R1SB1	Riverine	Bedrock, Streambed, Tidal, Riverine	R1SB1-RIVERINE, TIDAL, STREAMBED, BEDROCK
R1SB2	Riverine	Rubble, Streambed, Tidal, Riverine	R1SB2-RIVERINE, TIDAL, STREAMBED, RUBBLE
R1SB3	Riverine	Cobble-Gravel, Streambed, Tidal, Riverine	R1SB3-RIVERINE, TIDAL, STREAMBED, COBBLE
R1SB4	Riverine	Sand, Streambed, Tidal, Riverine	R1SB4-RIVERINE, TIDAL, STREAMBED, SAND
R1SB5	Riverine	Mud, Streambed, Tidal, Riverine	R1SB5-RIVERINE, TIDAL, STREAMBED, MUD
R1SB6	Riverine	Organic, Streambed, Tidal, Riverine	R1SB6-RIVERINE, TIDAL, STREAMBED, ORGANIC
R1SB7	Riverine	Vegetated, Streambed, Tidal, Riverine	R1SB7-RIVERINE, TIDAL, STREAMBED, VEGETATED
R1UB	Riverine	Unconsolidated Bottom, Tidal, Riverine	R1UB-RIVERINE, TIDAL, UNCONSOLIDATED BOTTOM
R1UB1	Riverine	Cobble-Gravel, Unconsolidated Bottom, Tidal, Riverine	R1UB1-RIVERINE, TIDAL, UNCONSOL BOTTOM, COBBLE
R1UB2	Riverine	Sand, Unconsolidated Bottom, Tidal, Riverine	R1UB2-RIVERINE, TIDAL, UNCONSOL BOTTOM, SAND
R1UB3	Riverine	Mud, Unconsolidated Bottom, Tidal, Riverine	R1UB3-RIVERINE, TIDAL, UNCONSOL BOTTOM, MUD
R1UB4	Riverine	Organic, Unconsolidated Bottom, Tidal, Riverine	R1UB4-RIVERINE, TIDAL, UNCONSOL BOTTOM, ORGAN
R1US	Riverine	Unconsolidated Shore, Tidal, Riverine	R1US-RIVERINE, TIDAL, UNCONSOL SHORE
R1US1	Riverine	Cobble-Gravel, Unconsolidated Shore, Tidal, Riverine	R1US1-RIVERINE, TIDAL, UNCONSOL SHORE, COBBLE
R1US2	Riverine	Sand, Unconsolidated Shore, Tidal, Riverine	R1US2-RIVERINE, TIDAL, UNCONSOL SHORE, SAND
R1US3	Riverine	Mud, Unconsolidated Shore, Tidal, Riverine	R1US3-RIVERINE, TIDAL, UNCONSOL SHORE, MUD
R1US4	Riverine	Organic, Unconsolidated Shore, Tidal, Riverine	R1US4-RIVERINE, TIDAL, UNCONSOL SHORE, ORGANIC
R1US5	Riverine	Vegetated, Unconsolidated Shore, Tidal, Riverine	R1US5-RIVERINE, TIDAL, UNCONSOL SHORE, VEGETAT
R2	Riverine	Lower Perennial, Riverine	R2-RIVERINE, LOWER PERENNIAL
R2AB	Riverine	Aquatic Bed, Lower Tidal, Riverine	R2AB-RIVERINE, LOWER PEREN, AQUA BED
R2AB1	Riverine	Algal, Aquatic Bed, Lower Tidal, Riverine	R2AB1-RIVERINE, LOWER PEREN, AQUA BED, ALGAL
R2AB2	Riverine	Aquatic Moss, Aquatic Bed, Lower Tidal, Riverine	R2AB2-RIVERINE, LOWER PEREN, AQUA BED, AQ MOSS
R2AB3	Riverine	Rooted Vascular, Aquatic Bed, Lower Tidal, Riverine	R2AB3-RIVERINE, LOWER PEREN, AQUA BED, ROOT VASC
R2AB4	Riverine	Floating Vascular, Aquatic Bed, Lower Tidal, Riverine	R2AB4-RIVERINE, LOWER PEREN, AQUA BED, FLOAT VAS
R2AB5	Riverine	Unknown Submergent, Aquatic Bed, Lower Tidal, Riverine	R2AB5-RIVERINE, LOWER PEREN, AQUA BED, UNK SUB
R2AB6	Riverine	Unknown Surface, Aquatic Bed, Lower Tidal, Riverine	R2AB6-RIVERINE, LOWER PEREN, AQUA BED, UNK SURF
R2EM	Riverine	Emergent, Lower Tidal, Riverine	R2EM-RIVERINE, LOWER PEREN, EMERGENT
R2EM2	Riverine	Nonpersistent, Emergent, Lower Tidal, Riverine	R2EM2-RIVERINE, LOWER PEREN, EMERGENT, NONPERS
R2RB	Riverine	Rock Bottom, Lower Perennial, Riverine	R2RB-RIVERINE, LOWER PEREN, ROCK BOTTOM
R2RB1	Riverine	Bedrock, Rock Bottom, Lower Perennial, Riverine	R2RB1-RIVERINE, LOWER PEREN, ROCK BOT, BEDROCK
R2RB2	Riverine	Rubble, Rock Bottom, Lower Perennial, Riverine	R2RB2-RIVERINE, LOWER PEREN, TOCK BOT, RUBBLE
R2RS	Riverine	Rocky Shore, Lower Tidal, Riverine	R2RS-RIVERINE, LOWER PEREN, ROCKY SHORE
R2RS1	Riverine	Bedrock, Rocky Shore, Lower Tidal, Riverine	R2RS1-RIVERINE, LOWER PEREN, ROCKY SHORE, BEDRK
R2RS2	Riverine	Rubble, Rocky Shore, Lower Tidal, Riverine	R2RS2-RIVERINE, LOWER PEREN, ROCKY SHORE, RUBBL
R2UB	Riverine	Unconcolidated Bottom, Lower Perennial, Riverine	R2UB-RIVERINE, LOWER PEREN, UNCONSOL BOT
R2UB1	Riverine	Cobble-Gravel, Unconsolidated Bottom, Lower Perennial, Riverine	R2UB1-RIVERINE, LOWER PEREN, UNCONSOL BOT, COB
R2UB2	Riverine	Sand, Unconsolidated Bottom, Lower Perennial, Riverine	R2UB2-RIVERINE, LOWER PEREN, UNCONSOL BOT, SAN
R2UB3	Riverine	Mud, Unconsolidated Bottom, Lower Perennial, Riverine	R2UB3-RIVERINE, LOWER PEREN, UNCONSOL BOT, MUD
R2UB4	Riverine	Organic, Unconsolidated Bottom, Lower Perennial, Riverine	R2UB4-RIVERINE, LOWER PEREN, UNCONSOL BOT, ORG
R2US	Riverine	Unconsolidated Shore, Lower Tidal, Riverine	R2US-RIVERINE, LOWER PEREN, UNCONSOL SHORE
R2US1	Riverine	Cobble-Gravel, Unconsolidated Shore, Lower Tidal, Riverine	R2US1-RIVERINE, LOWER PEREN, UNCONSOL SHR, COB
R2US2	Riverine	Sand, Unconsolidated Shore, Lower Tidal, Riverine	R2US2-RIVERINE, LOWER PEREN, UNCONSOL SHR, SAN
R2US3	Riverine	Rooted Vascular, Unconsolidaated Shore, Lower Tidal, Riverine	R2US3-RIVERINE, LOWER PEREN, UNCONSOL SHR, RV
R2US4	Riverine	Floating Vascular, Unconsolidated Shore, Lower Tidal, Riverine	R2US4-RIVERINE, LOWER PEREN, UNCONSOL SHR, FV
R2US5	Riverine	Unknown Submergent, Unconsolidated Shore, Lower Tidal, Riverine	R2US5-RIVERINE, LOWER PEREN, UNCONSOL SHR, UN SUB
R2US6	Riverine	Unknown Surface, Unknown Surface, Lower Tidal, Riverine	R2US6-RIVERINE, LOWER PEREN, UNCONSOL SHR, UNK SUR
R3	Riverine	Upper Perennial, Riverine	R3-RIVERINE, UPPER PERENNIAL
R3AB	Riverine	Aquatic Bed, Upper Perennial, Riverine	R3AB-RIVERINE, UPPER PEREN, AQUA BED
R3AB1	Riverine	Algal, Aquatic Bed, Upper Perennial, Riverine	R3AB1-RIVERINE, UPPER PEREN, AQUA BED, ALGAL
R3AB2	Riverine	Aquatic Moss, Aquatic Bed, Upper Perennial, Riverine	R3AB2-RIVERINE, UPPER PEREN, AQUA BED, AQUA MOSS
R3AB3	Riverine	Rooted Vascular, Aquatic Bed, Upper Perennial, Riverine	R3AB3-RIVERINE, UPPER PEREN, AQUA BED, ROOT VAS
R3AB4	Riverine	Floating Vascular, Aquatic Bed, Upper Perennial, Riverine	R3AB4-RIVERINE, UPPER PEREN, AQUA BED, FLOAT VAS

Notes for Aquatic Resource Excel Sheet

R3AB5	Riverine	Unknown Submergent, Aquatic Bed, Upper Perennial, Riverine	R3AB5-RIVERINE, UPPER PEREN, AQUA BED, UNK SUB
R3AB6	Riverine	Unknown Surface, Aquatic Bed, Upper Perennial, Riverine	R3AB6-RIVERINE, UPPER PEREN, AQUA BED, UNK SURF
R3RB	Riverine	Rock Bottom, Upper Perennial, Riverine	R3RB-RIVERINE, UPPER PEREN, ROCK BOTTOM
R3RB1	Riverine	Bedrock, Rock Bottom, Upper Perennial, Riverine	R3RB1-RIVERINE, UPPER PEREN, ROCK BOT, BEDROCK
R3RB2	Riverine	Rubble, Rock Bottom, Upper Perennial, Riverine	R3RB2-RIVERINE, UPPER PEREN, ROCK BOT, RUBBLE
R3RS	Riverine	Rocky Shore, Upper Perennial, Riverine	R3RS-RIVERINE, UPPER PEREN, ROCKY SHORE
R3RS1	Riverine	Bedrock, Rocky Shore, Upper Perennial, Riverine	R3RS1-RIVERINE, UPPER PEREN, ROCKY SHR, BEDROCK
R3RS2	Riverine	Rubble, Rocky Shore, Upper Perennial, Riverine	R3RS2-RIVERINE, UPPER PEREN, ROCKY SHR, RUBBLE
R3UB	Riverine	Unconsolidated Bottom, Upper Perennial, Riverine	R3UB-RIVERINE, UPPER PEREN, UNCONSOL BOT
R3UB1	Riverine	Cobble-Gravel, Unconsolidated Bottom, Upper Perennial, Riverine	R3UB1-RIVERINE, UPPER PEREN, UNCONSOL BOT, COBBLE
R3UB2	Riverine	Sand, Unconsolidated Bottom, Upper Perennial, Riverine	R3UB2-RIVERINE, UPPER PEREN, UNCONSOL BOT, SAND
R3UB3	Riverine	Mud, Unconsolidated Bottom, Upper Perennial, Riverine	R3UB3-RIVERINE, UPPER PEREN, UNCONSOL BOT, MUD
R3UB4	Riverine	Organic, Unconsolidated Bottom, Upper Perennial, Riverine	R3UB4-RIVERINE, UPPER PEREN, UNCONSOL BOT, ORGAN
R3US	Riverine	Unconsolidated Shore, Upper Perennial, Riverine	R3US-RIVERINE, UPPER PEREN, UNCONSOL SHR
R3US1	Riverine	Cobble-Gravel, Unconsolidated Shore, Upper Perennial, Riverine	R3US1-RIVERINE, UPPER PEREN, UNCONSOL SHR, COBBLE
R3US2	Riverine	Sand, Unconsolidated Shore, Upper Perennial, Riverine	R3US2-RIVERINE, UPPER PEREN, UNCONSOL SHR, SAND
R3US3	Riverine	Mud, Unconsolidated Shore, Upper Perennial, Riverine	R3US3-RIVERINE, UPPER PEREN, UNCONSOL SHR, MUD
R3US4	Riverine	Organic, Unconsolidated Shore, Upper Perennial, Riverine	R3US4-RIVERINE, UPPER PEREN, UNCONSOL SHR, ORGANIC
R3US5	Riverine	Vegetated, Unconsolidated Shore, Upper Perennial, Riverine	R3US5-RIVERINE, UPPER PEREN, UNCONSOL SHR, VEGETATED
R4	Riverine	Intermittent, Riverine	R4-RIVERINE, INTERMIT
R4SB	Riverine	Streambed, Intermittent, Riverine	R4SB-RIVERINE, INTERMIT, STREAMBED
R4SB1	Riverine	Bedrock, Streambed, Intermittent, Riverine	R4SB1-RIVERINE, INTERMIT, STREAMBED, BEDROCK
R4SB2	Riverine	Rubble, Streambed, Intermittent, Riverine	R4SB2-RIVERINE, INTERMIT, STREAMBED, RUBBLE
R4SB3	Riverine	Cobble-Gravel, Streambed, Intermittent, Riverine	R4SB3-RIVERINE, INTERMIT, STREAMBED, COBBLE
R4SB4	Riverine	Sand, Streambed, Intermittent, Riverine	R4SB4-RIVERINE, INTERMIT, STREAMBED, SAND
R4SB5	Riverine	Mud, Streambed, Intermittent, Riverine	R4SB5-RIVERINE, INTERMIT, STREAMBED, MUD
R4SB6	Riverine	Organic, Streambed, Intermittent, Riverine	R4SB6-RIVERINE, INTERMIT, STREAMBED, ORGANIC
R4SB7	Riverine	Vegetated, Streambed, Intermittent, Riverine	R4SB7-RIVERINE, INTERMIT, STREAMBED, VEGETATED
R5	Riverine	Unknown Perennial, Riverine	R5-RIVERINE, UNKNOWN PERENNIAL
R5AB	Riverine	Aquatic Bed, Unknown Perennial, Riverine	R5AB-RIVERINE, UNK PEREN, AQUA BED
R5AB1	Riverine	Algal, Aquatic Bed, Unknown Perennial, Riverine	R5AB1-RIVERINE, UNK PEREN, AQUA BED, ALGAL
R5AB2	Riverine	Aquatic Moss, Aquatic Bed, Unknown Perennial, Riverine	R5AB2-RIVERINE, UNK PEREN, AQUA BED, AQUA MOSS
R5AB3	Riverine	Rooted Vascular, Aquatic Bed, Unknown Perennial, Riverine	R5AB3-RIVERINE, UNK PEREN, AQUA BED, ROOT VASC
R5AB4	Riverine	Floating Vascular, Aquatic Bed, Unknown Perennial, Riverine	R5AB4-RIVERINE, UNK PEREN, AQUA BED, FLOAT VASC
R5AB5	Riverine	Unknown Submergent, Aquatic Bed, Unknown Perennial, Riverine	R5AB5-RIVERINE, UNK PEREN, AQUA BED, UNK SUB
R5AB6	Riverine	Unknown Surface, Aquatic Bed, Unknown Perennial, Riverine	R5AB6-RIVERINE, UNK PEREN, AQUA BED, UNK SURF
R5RB	Riverine	Rock Bottom, Unknown Perennial, Riverine	R5RB-RIVERINE, UNK PEREN, ROCK BOTTOM
R5RB1	Riverine	Bedrock, Rock Bottom Unknown Perennial, Riverine	R5RB1-RIVERINE, UNK PEREN, ROCK BOTTOM, BEDROCK
R5RB2	Riverine	Rubble, Rock Bottom, Unknown Perennial, Riverine	R5RB2-RIVERINE, UNK PEREN, ROCK BOTTOM, RUBBLE
R5RS	Riverine	Rocky Shore, Unknown Perennial, Riverine	R5RS-RIVERINE, UNK PEREN, ROCKY SHORE
R5RS1	Riverine	Bedrock, Rocky Shore, Unknown Perennial, Riverine	R5RS1-RIVERINE, UNK PEREN, ROCKY SHORE, BEDROCK
R5RS2	Riverine	Rubble, Rocky Shore, Unknown Perennial, Riverine	R5RS2-RIVERINE, UNK PEREN, ROCKY SHORE, RUBBLE
R5UB	Riverine	Unconsolidated Bottom, Unknown Perennial, Riverine	R5UB-RIVERINE, UNK PEREN, UNCONSOLIDATED BOTTOM
R5UB1	Riverine	Cobble-Gravel, Unconsolidated Bottom, Unknown Perennial, Riverine	R5UB1-RIVERINE, UNK PEREN, UNCONSOL BOT, COBBLE
R5UB2	Riverine	Sand, Unconsolidated Bottom, Unknown Perennial, Riverine	R5UB2-RIVERINE, UNK PEREN, UNCONSOL BOT, SAND
R5UB3	Riverine	Mud, Unconsolidated Bottom, Unknown Perennial, Riverine	R5UB3-RIVERINE, UNK PEREN, UNCONSOL BOT, MUD
R5UB4	Riverine	Organic, Unconsolidated Bottom, Unknow Perennial, Riverine	R5UB4-RIVERINE, UNK PEREN, UNCONSOL BOT, ORGANIC
R5US	Riverine	Unconsolidated Shore, Unknown Perennial, Riverine	R5US-RIVERINE, UNK PEREN, UNCONCOL SHORE
R5US1	Riverine	Cobble-Gravel, Unconsolidated Shore, Riverine	R5US1-RIVERINE, UNK PEREN, UNCONSOL SHR, COBBLE
R5US2	Riverine	Sand, Unconsolidated Shore, Unknown Perennial, Riverine	R5US2-RIVERINE, UNK PEREN, UNCONSOL SHR, SAND
R5US3	Riverine	Mud, Unconsolidated Shore, Unknown Perennial, Riverine	R5US3-RIVERINE, UNK PEREN, UNCONSOL SHR, MUD
R5US4	Riverine	Organic, Unconsolidated Shore, Unknown Perennial, Riverine	R5US4-RIVERINE, UNK PEREN, UNCONSOL SHR, ORGANIC
R5US5	Riverine	Vegetated, Unconsolidated Shore, Unknown Perennial, Riverine	R5US5-RIVERINE, UNK PEREN, UNCONSOL SHR, VEGETATED
R6	Riverine	A wetland, spring, stream, river, pond or lake that only exists for a short period	R6 - RIVERINE, EPHEMERAL
U	Uplands	Upland - Not a wetland or deepwater habitat of the United States as described by Cowardin.	U-UPLANDS





**DRAFT**

# Airport Layout Plan Narrative Report



# CROWS LANDING AIRPORT



February 2017



# **Crows Landing Airport Layout Plan Narrative Report**

February 2017

Prepared for  
**Stanislaus County**  
Department of Planning and  
Community Development  
1010 10th Street, Suite 6800  
Modesto, CA 95354

Prepared by



Mead & Hunt, Inc.



# Table of Contents

## CHAPTER 1 INTRODUCTION

BACKGROUND.....	1-1
Conceptual Design .....	1-2
Crows Landing Airport Layout Plan (ALP).....	1-2
Figure 1A Location Map.....	1-4
Figure 1B Airport Location and Property Boundaries .....	1-5

## CHAPTER 2 AIRPORT ROLE AND ACTIVITY FORECASTS

INTRODUCTION.....	2-1
METHODOLOGY.....	2-1
Based Aircraft.....	2-2
Aircraft Operations .....	2-4
At Opening: (0 – 10 Years) .....	2-4
Future Development (11 to 30 Years).....	2-5
AVIATION FORECAST SUMMARY .....	2-6
Table 2-1 Activity Forecasts .....	2-7
Table 2-2 Area Airports .....	2-8
Figure 2A Representative Aircraft .....	2-9

## CHAPTER 3 AIRPORT DEVELOPMENT CONCEPTS

INTRODUCTION .....	3-1
AIRPORT DEVELOPMENT OVERVIEW .....	3-1
At Opening: 0 – 10 Years.....	3-1
Future Development 11 – 30 Year .....	3-2
Ultimate Buildout: >30 Years .....	3-3
AIRPORT DESIGN FACTORS .....	3-4
Airport Classification and Design Aircraft .....	3-4
Wind Coverage .....	3-5
RUNWAY DESIGN .....	3-5
Runway Configuration .....	3-5
Runway Length .....	3-6
Runway Width .....	3-6
Runway Safety Areas .....	3-7
Object Free Areas .....	3-7
Obstacle Free Zones .....	3-7
Runway Protection Zone.....	3-7
Building Restriction Line .....	3-8
Other Runway Features .....	3-9
Visual Approach Aids .....	3-9
Electronic Navigational Aids .....	3-11
Taxiways .....	3-11
Taxiway Design .....	3-11
Taxiway Designations .....	3-11
Runway-to-Taxiway Separation .....	3-12
Taxiway Object Free Area .....	3-12
Signage .....	3-12
Helicopter Takeoff and Landing Area .....	3-13

TABLE OF CONTENTS

Building Area Design Factors .....	3-13
Aircraft Hangars .....	3-13
Aircraft Apron .....	3-15
Airport Operations Office .....	3-15
Fixed Base Operations Facilities .....	3-15
Other Support Facilities .....	3-16
Safety and Security .....	3-16
Utilities .....	3-17
Drainage .....	3-17
Road Access .....	3-17
Table 3-1 Airport Development Concepts .....	3-18
Table 3-2 Airport Design Standards .....	3-19
Figure 3A Building Area Inset – At Opening (0-10 Years).....	3-21
Figure 3B Building Area Inset – Future (11-30 Years).....	3-22
Figure 3C Building Area Inset – Build Out (30+ Years) .....	3-23

**CHAPTER 4 AIRPORT PLANS**

AIRPORT LAYOUT PLANS DRAWINGS.....	4-1
Airport Layout Plan .....	4-2
Airspace Plan .....	4-2
FINANCIAL FACTORS .....	4-2
Development Staging.....	4-3
Financial Issues .....	4-3
Management and Operational Issues .....	4-3
Funding Sources .....	4-4
Cost Estimates .....	4-6
NOISE IMPACTS .....	4-6
Table 4-1 Pre-Opening Issues .....	4-4
Table 4-2 Capital Improvement Plan Cost Estimates .....	4-8
Table 4-3 Typical Decibel Level of Common Sounds .....	4-9
Table 4-4 Airport Activity Data Summary .....	4-10
Figure 4A Airport Improvement Staging Plan .....	4-11
Figure 4B Noise Impacts – At Opening (Year 1) .....	4-12
Figure 4C Noise Impacts – Long-Range (11-30 Years) .....	4-13

**APPENDICES**

A	Glossary of Terms
B	Aircraft Owner Summary Table
C	Airport Layout Plan Drawing
Sheet 1	Index
Sheet 2	Airport Layout Plan
Sheet 3	Airport Data
Sheet 4	Part 77 Airspace Plan
Sheet 5	Inner Approach Plan & Profile
Sheet 6	Exhibit A Property Map

---

**CHAPTER 1**  
**INTRODUCTION**





## INTRODUCTION

The County of Stanislaus proposes to reuse a portion of the former Crows Landing Naval Air Facility as a public-use, general aviation (GA) airport and an amenity to the Crows Landing Industrial Business Park (CLIBP). The purpose of this *Airport Layout Plan (ALP) Narrative Report* is to facilitate the development and opening of the new Crows Landing Airport. The ALP Narrative Report focuses on the immediate needs associated with opening a GA facility and documents the County's short-term and long-range development goals. Certain items, such as detailed land use plans, financial plans, management, and fixed-base operation arrangements are not specifically addressed in this report; these specific items will be studied as needs arise and budgets permit.

Crows Landing Airport is located in the northwestern portion of the San Joaquin Valley in Stanislaus County, California. The airport is less than 1 mile east of Interstate 5 and the Fink Road interchange, which provides regional highway connections to both Sacramento and the San Francisco Bay Area. The airport is situated 1.6 miles west of the community of Crows Landing, 4 miles south of the community of Patterson, and 80 miles southeast of the City of San Francisco (see the location map in **Figure 1A**).

## BACKGROUND

The former Crows Landing Naval Auxiliary Landing Field was commissioned in 1943 to serve as a training field during World War II. The facility was reduced to caretaker status following World War II until the early 1950s, when it was used for fleet carrier landing practice during the Korean War. Throughout the 1970s and 1980s, the facility was used for practice operations by the Navy, Air Force, Army, and Coast Guard. The National Aeronautics and Space Administration (NASA) Ames Research Center, located at Moffett Field, took over operation of the facility in 1994 and ceased operations in 1997, when they proposed to declare the base as excess. Congress passed H.R. 356 in 1999, which states that, "as soon as practicable, the Administrator



---

of NASA shall convey to Stanislaus County, California, all right, title, and interest of the United States in and to the former Crows Landing Air Facility.”

Since the decommissioning of the facility by NASA in the late 1990s, the Stanislaus County Board of Supervisors has pursued and studied reuse opportunities for the site. In April 2001, the Board adopted a reuse plan that would designate a portion of the property for use as a GA airport and develop other areas of the property to help offset the jobs-to-housing imbalance that has historically persisted in Stanislaus County. On October 12, 2004, the Stanislaus County Board of Supervisors accepted the conveyance of land pursuant to Public Law 106-82. The County envisioned optimizing the site’s opportunities for economic development by creating a regional job center while maintaining an aviation use.

## Conceptual Design

In 2006, the County developed and evaluated three land use scenarios, or concepts, to support the development of the Crows Landing Airport. The three concepts were designed to determine the extent to which the existing aviation facilities and infrastructure could be reused and integrated with new aviation-compatible uses on the remaining property:

- Concept 1: Maintain and build upon the existing intersecting runway configuration;
- Concept 2: Maintain and protect for ultimate build-out aviation facilities based upon the north/south runway (Runway 16-34); and
- Concept 3: Maintain and protect for ultimate build-out of aviation facilities based upon the northwest/southeast runway (Runway 11-29).

In September 2006, the County Board of Supervisors approved Concept 3 for the Crows Landing Airport and authorized staff to seek a long-term development partner to assist in the finance, design, build, and operation of aviation-compatible land uses in the form of an industrial business park on the site of the former Crows Landing Air Facility (Action Item No. 2006-776). **Figure 1B** depicts the former Crows Landing Air Facility property and the location of the Crows Landing Airport as envisioned by Concept 3.

Since 2007, the County has worked closely with area residents, members of the business community, and regulatory agencies to envision a GA airport that would meet the needs of the aviation community and complement the development of a regional employment center on the former military facility. A draft Airport Layout Plan (ALP) was developed and presented to the public during various community meetings from 2008 to 2014. Since then, the ALP has been modified to reflect suggestions offered by various stakeholders and to reflect changes in regional and national economic conditions. The proposed design, as described below, continues to reflect the reuse concept approved by the Board of Supervisors in 2006.

## Airport Layout Plan

The purpose of this ALP report is to describe the requirements for the overall design of the Crows Landing Airport and present a recommended ALP drawing. The primary objective of this ALP is to document the extent, type, and approximate schedule of development needed to accommodate the opening of, and future aviation demand for, the Crows Landing Airport. The ALP will serve three major functions:

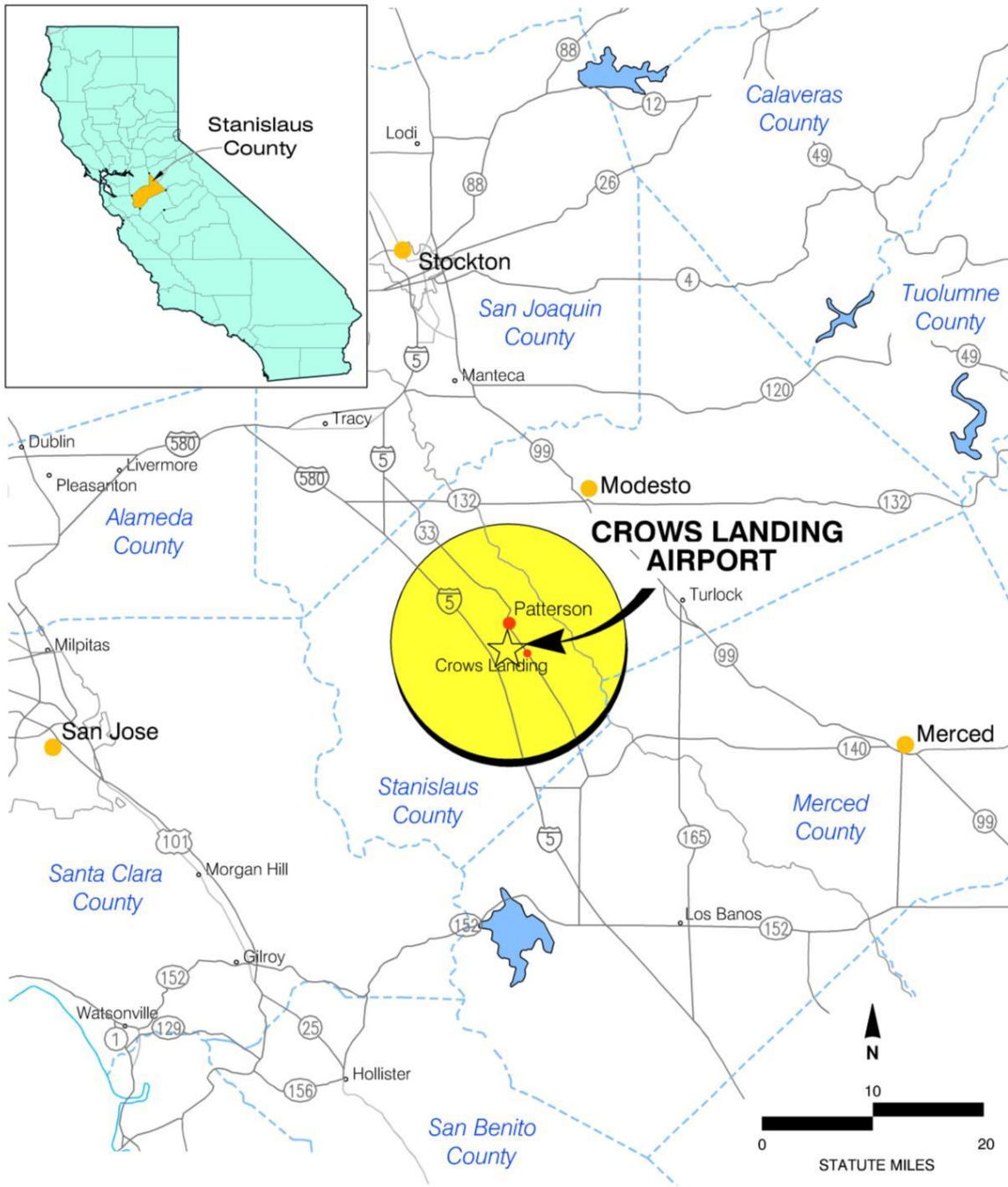
---

- 
- The ALP will document existing aviation facilities at the former military facility and generally describe future development plans for the airport. This information will assist the County of Stanislaus, as the airport operator, in obtaining required approvals from various reviewing agencies, including the California Department of Transportation's Division of Aeronautics and the Stanislaus County Airport Land Use Commission. The ALP will also serve as the basis for subsequent Federal Aviation Administration (FAA) review, approval, and funding.
  - The ALP will help the County make decisions on how best to operate and develop the airport to meet future demand.
  - The ALP will serve as a basis for amending the Stanislaus County Airport Land Use Compatibility Plan (ALUCP) to include the Crows Landing Airport and its anticipated use as a GA facility.

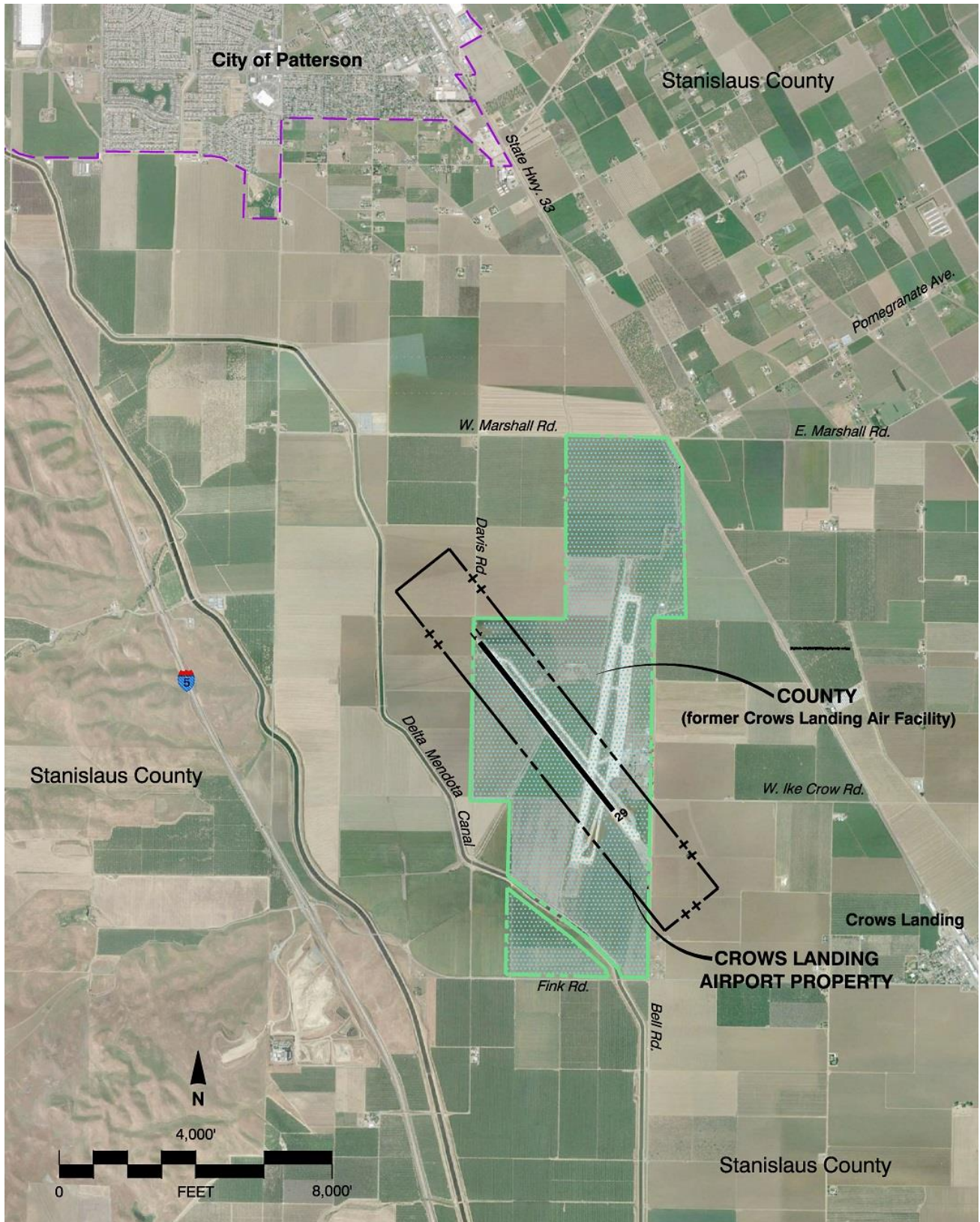
This ALP report is organized into four chapters. Subsequent chapters provide the following information:

- **Chapter 2** presents aircraft activity forecasts for the proposed stages of airport development. The forecasts generally identify the fleet mix, number of based aircraft, and number of annual aircraft operations that would be accommodated under each stage of development. The forecasts are used to develop building area concepts and aircraft noise contours for the airport.
- **Chapter 3** describes three potential airfield and building area development plans for the airport: during its first 30 years of operation and beyond. The assumed facilities, services, and capabilities that would be associated with the airport at various milestones following its opening as a public-use GA facility are identified. Costs estimates for the various stages of development and for individual projects are also presented.
- **Chapter 4** presents the conceptual designs for the proposed Crows Landing Airport including the ALP drawing, an airspace plan drawing reflecting the ultimate runway configuration for the airport, and existing and ultimate aircraft noise contours. The ALP approval process is also described.

Appendices are included to present supporting materials, including a glossary of terms, a copy of the completed FAA ALP checklist, and a synopsis of the *Aircraft Owner Survey* completed in January 2006 for the proposed Crows Landing Airport. The report concludes with a complete set of ALP drawings.



**Figure 1A. Location Map**



**Figure 1B. Airport and Property Boundaries**



**CHAPTER 2**

---

**AIRPORT ROLE AND ACTIVITY FORECASTS**





# 2

## AIRPORT ROLE AND ACTIVITY FORECASTS

### INTRODUCTION

Stanislaus County has designated the former Crows Landing Naval Air Facility as the Crows Landing Industrial Business Park (CLIBP). The County will develop a 370-acre portion of the 1,528-acre CLIBP as a general aviation (GA) airport. The primary market the County desires to serve is personal/recreational and business/corporate aircraft, while retaining the flexibility to accommodate commercial air cargo should demand warrant it in the future.

The aircraft activity forecasts developed for this ALP emphasize the airport's role as a public-use GA facility and its anticipated use by business aircraft associated with the adjacent industrial and business park. To provide operational flexibility, the proposed Crows Landing Airport would be sufficiently sized and equipped to readily accommodate small- to medium-sized air cargo/air freight feeder aircraft (e.g., Cessna Caravans, Beech 99s, Lear Jets, retrofitted twin-turboprop commuter aircraft, etc.). The airport's use by large air cargo aircraft is neither envisioned nor considered in this ALP report. **Figure 2A** presents the type of aircraft that would use the proposed Crows Landing Airport.

Forecasts of aeronautical activity at an airport are an essential component for both facility planning and environmental impact assessment. The two key forecast elements are based aircraft and annual airport operations (i.e., landings and takeoffs). The forecast of annual operations includes both local and itinerant operations. Local operations are those that remain in the immediate vicinity of the airport; such as flight training operations. Itinerant operations refer to departures that leave the airport vicinity or arrivals from outside the airport vicinity.

### METHODOLOGY

The projection of historical trends is the most common method of forecasting activity at GA airports. Because the proposed Crows Landing Airport does not have an operating history as a public-use, general aviation airport, alternative methods have been employed to forecast aircraft operations. The FAA's *Aerospace Forecast* was used to define broad trends in regional and national general aviation activity. However, the FAA's forecast is of limited utility in a quantitative sense. Growth in aviation activity at the proposed Crows Landing Airport will be driven by the unique features of its location and the overall success of the CLIBP, which will include logistics, light industrial, and business park uses.

---

The relocation of aircraft from other airports will be the primary source of based aircraft growth in the early years; the initial forecasts have been developed by drawing inferences from experience with recent hangar development projects and historical examples of airport development at other airports (e.g., Contra Costa County's Byron Airport). Longer-term forecasts were principally shaped by assumptions about the nature of the adjacent industrial development and long-term regional and national general aviation growth factors.

Each forecast that follows is defined by the mix of facilities and services that would be available at each stage of development. These features are presented in greater detail in Chapter 3. Although these forecasts are tied to each stage of development described throughout this report (e.g., At Opening, Short-term, and Long Range. , it is more appropriate to think of these forecasts as linked to the specific facilities and services listed for each phase of airport development. The text that follows describes the factors used to shape the forecasts. The subsequent section presents the development scenarios and their associated forecasts. The activity forecasts are summarized in Table 2-1.

## **Based Aircraft**

Growth in based aircraft will be determined initially by the number of aircraft that relocate from nearby airports. Experience has shown that people are generally willing to drive up to 30 minutes from their home or office to the airport where their aircraft are based. Specific circumstances can result in a willingness to drive longer distances, including:

- The absence of a suitable airport within a 30-minute drive,
- The absence of critical facilities or services at nearer airports (e.g., runway lights, instrument approach procedure, hangars, or Jet A fuel),
- Superior weather conditions,
- Closure of nearby airports (e.g., Patterson Airport and Turlock Air Park), and
- Significantly lower costs for fuel, hangars, etc.

The community nearest to Crows Landing Airport is the City of Patterson. Patterson is located approximately 4 miles north of Crows Landing Airport. The City's GA Airport closed in recent years the property has been designated for other uses. Several larger communities are within 30 minutes driving time of the airfield including: Tracy, Modesto and Merced. Based upon the most recent Airport Master Records for airports in the area (i.e., Tracy, New Jerusalem, Modesto, Turlock, Merced, Castle, Gustine, and Los Banos), about 579 aircraft are based at airports in the region surrounding Crows Landing Airport. Aircraft owners in those communities will likely consider moving to Crows Landing Airport if the quality and price of facilities and services provided are significantly superior to those offered at their current location or similar services are not available at their current location. Table 2-2 presents the facilities currently available at these nearby airports. The superiority of the facilities and services at Crows Landing Airport must outweigh the cost and inconvenience of driving to the airport. Therefore, the forecasts include explicit assumptions on the facilities and services that will be available at each stage of development. The forecasts also assume that the County will offer competitive prices for facilities and services provided at the Crows Landing Airport.

---

The January 2006, the County invited aircraft owners in the region surrounding the former Crows Landing Air Facility to participate in a survey (Aircraft Owner Survey). A summary of the completed survey is provided in Appendix C. Of the 55 responses received, 37 indicated a moderate to high level of interest in relocating to Crows Landing Airport. As could be expected, the interest in relocating to Crows Landing Airport was linked to the availability of facilities:

- 78% indicated that availability of self-serve general aviation gas was very important
- 73% indicated that availability of T-hangars was very important
- 62% indicated that airfield lighting was very important
- 36% indicated that availability of an instrument approach procedure was very important

Based on recent experience with hangar projects at various airports, it would be expected that 25% to 50% of those expressing interest would be willing to relocate. Therefore, if appropriate facilities were available at a competitive price, it is anticipated that 10 to 20 of the aircraft owners contacted would actually relocate. Residents of the communities of Patterson, Crows Landing, or Diablo Grande might acquire aircraft if Crows Landing Airport were available.

Aviation businesses are another potential source of based aircraft. Aviation businesses that provide flight training or charter services (collectively known as fixed-base operators or FBOs) are aviation businesses that are likely to have based aircraft. As with other aircraft owners, the attractiveness of the airport to these aviation businesses will depend upon the characteristics (e.g., availability of utilities, ability to use existing aprons and auto parking areas, proximity to markets) and price of leaseholds. The number of based aircraft and existence of other FBOs will also be factors affecting the attractiveness of Crows Landing Airport. No substantial aviation businesses are likely to base operations at Crows Landing Airport until runway lights are installed. Given the occurrence of fog, charter and fractional ownership operators are unlikely to base at the airport until there is an instrument approach that would provide at least  $\frac{3}{4}$  mile visibility minimums, which will require some form of an approach lighting system. Some aviation businesses are unlikely to own aircraft, such as those that provide aircraft maintenance, painting, upholstery, and avionics.

The ongoing development of the Crows Landing Industrial Business Park is expected to generate some based aircraft. However, current trends in charter and fractional aircraft ownership suggest that many of the businesses in the proposed business park that use aircraft will not have an aircraft based at the airport. Instead, these businesses will utilize aircraft based at other airports that service them on a transient basis.

Most aircraft based at Crows Landing Airport would likely be single-engine, piston-powered aircraft. The based aircraft would be used largely for personal/recreational purposes. Given the limited facilities available in early years, these aircraft will principally be attracted by low prices. The availability of low-cost hangars will be a critical factor.

---

## Aircraft Operations

An aircraft operation is defined as either a landing or a takeoff. A common training maneuver called a touch-and-go consists of a landing immediately followed by a takeoff without stopping. A touch-and-go counts as two operations. Operations at Crows Landing Airport will be generated by both based and transient aircraft. Operations are expected to be generated by:

- Flight training
- Trips by based aircraft
- Aircraft receiving services from FBOs
- Aircraft from other airports transporting passengers to/from Crows Landing Airport
- Law enforcement, emergency response, and utility patrol aircraft

Aircraft used for business purposes commonly have much higher utilization rates than aircraft used for personal purposes (e.g., recreational and personal business). Aircraft used in flight training also commonly have high utilization rates. An airport's utilization rate is typically expressed in terms of the annual operations per based aircraft. Based upon characteristics observed at other airports, the following ranges can be expected:

- An airport that does not have an FBO offering flight training or a significant number of based business aircraft will typically have a utilization rate of 100 to 200 annual operations per based aircraft.
- An airport that does not have an FBO offering flight training but does have significant number of based business aircraft will typically have a utilization rate of 200 to 400 annual operations per based aircraft.
- If a flight school is present at an airport or if an airport is regularly used for flight training by aircraft based at nearby airports, annual operations in the range of 400 to 500 operations per based aircraft are common.

The higher ends of the ranges are more likely to occur in metropolitan areas. Figure 2A illustrates representative aircraft in Airport Reference Codes B-II and C-II.

The annual operations forecasts associated with the 30-year planning horizon are summarized below. Additional detail is presented in Chapter 3.

## At Opening Through Year 10

### Opening/Year 1

- Based Aircraft = 10 (5 on tie-downs and 5 in basic privately-developed Port-A-Ports / hangars)
  - This is an optimistic number; 5 based aircraft is more realistic
  - All aircraft are likely to be single-engine, propeller airplanes
  - A few agricultural airplanes or a helicopter
- Total Annual Operations = 4,000 total operations

- 
- 1,000 operations by based aircraft
  - 3,000 operations, mostly touch-and-goes, by aircraft based at other airports

### **Year 5**

- Based Aircraft = 15 (5 on tie-downs and 10 in basic privately-developed Port-A-Ports / hangars)
  - Majority of aircraft are likely to be single-engine, propeller airplanes
  - Maybe a few multi-engine, propeller airplanes
  - Maybe a few agricultural airplanes
  - Some helicopters possible, but distances to major metropolitan areas makes this uncertain
- Total Annual Operations = 6,000 operations
  - 1,500 operations by based aircraft. At this point the airport would start to see aircraft use linked to business activities in the adjacent industrial park and the FBO
  - 4,500 operations, mostly touch-and-goes, by aircraft from other airports

### **6 to 10 Years**

- Based Aircraft = 20 (5 on tie-downs and 15 in Port-A-Ports / hangars)
  - Majority of aircraft are likely to be single-engine, propeller airplanes
  - A few multi-engine, piston airplanes
  - One or two turbine-powered aircraft (turboprops and/or jets)
  - A few agricultural airplanes
  - Some helicopters possible, but distances to major metropolitan areas makes this uncertain
- Total Annual Operations = 8,000 operations
  - 3,000 operations by based aircraft and transient aircraft providing transportation for passengers associated with the industrial and business park
  - 5,000 operations, mostly touch-and-goes, by aircraft from other airports

### **Future Development**

#### **11 to 20 Years**

- Based Aircraft = 40 (5 on tie-downs and 35 in Port-A-Ports / hangars)
  - Majority of aircraft are likely to be single-engine, propeller airplanes
  - A few multi-engine, piston airplanes
  - A few turbine-powered aircraft (turboprops and/or jets)
  - A few agricultural airplanes
  - Some helicopters possible, but distances to major metropolitan areas makes this uncertain
- Total Annual Operations = 16,000 operations
  - 11,000 operations by based aircraft and transient aircraft providing transportation for passengers associated with the industrial and business park
  - 5,000 operations, mostly touch-and-goes, by aircraft from other airports

#### **21 to 30 Years**

- Based Aircraft = 80 (15 on tie-downs and 65 in Port-A-Ports / hangars)
- Total Annual Operations = 34,000 operations
  - 15,000 annual touch-and-goes by aircraft based at the airport
  - 8,500 operations by jet and turboprop aircraft

---

## **Aviation Forecast Summary**

Aviation is subject to economic conditions, and the overall growth of general aviation is expected to be slow in the years ahead. Business/corporate use of general aviation aircraft is anticipated to continue to be the strongest sector of the general aviation industry, but even this segment of aviation is subject to economic conditions. National trends indicate that business/corporate aviation is using more sophisticated, turbine-powered aircraft. Crows Landing Airport is well positioned to serve business/corporate aircraft that are high-performance, single-engine airplanes, light to medium twin-engine aircraft, and corporate jets. The airport is likely to benefit from some of the projected growth in business/corporate use of the general aviation aircraft fleet. Additionally, a new class of advanced, small-turbine-powered jet aircraft is emerging in the general aviation industry. This small personal/business jet aircraft would be capable of operating on shorter runways (approximately 3,000 feet in length). Introduction of this class of jets could further enhance projected general aviation jet activity at Crows Landing Airport. Personal/recreational general aviation uses are also anticipated to become a large component of the airport's future based aircraft.

The proposed Crows Landing Airport is well suited to accommodate future increases in based aircraft and aircraft operations volumes. The airport is not seriously constrained with respect to airfield or building area capacities. The proposed Crows Landing Industrial Business Park will be developed with aviation-compatible uses, such as light industry, logistics, and government offices, and the adjacent property uses are agricultural. The number of projected future aircraft operations at Crows Landing Airport is not a major factor in the planning or design of improvements. The proposed runway/taxiway system is more than adequate to meet projected activity levels for the airport. In terms of building area capacity, the proposed Crows Landing Airport has approximately 132 acres available at build-out for future aviation-related development.

**Table 2-1. Activity Forecasts**

Forecast	Opening	Year 5	Year 10	Year 20	Year 30
<b>Based Aircraft</b>					
<b>Aircraft Type</b>	<b>(Number of Aircraft by Type)</b>				
Single-Engine, Piston	10	13	15	25	50
Twin-Engine, Piston	0	2	2	5	10
Turboprop	0	0	2	7	14
Jets	0	0	1	3	6
<b>Total Based Aircraft</b>	<b>10</b>	<b>15</b>	<b>20</b>	<b>40</b>	<b>80</b>
<b>Storage Demand</b>					
	<b>(Number of Spaces or Aprons Required)</b>				
Hangar Spaces	5	10	15	35	65
Aprons	5	5	5	5	15
<b>Total Aircraft</b>	<b>10</b>	<b>15</b>	<b>20</b>	<b>40</b>	<b>80</b>
<b>Annual Aircraft Operations</b>					
<b>Aircraft Mix</b>	<b>(Number of Operations by Aircraft Type)</b>				
Single-Engine, Piston Fixed-Pitch Prop	4,000	5,500	6,500	10,500	22,000
Twin-Engine, Piston		350	600	1,500	3,500
Turboprop		100	600	2,500	5,000
Jets		50	300	1,500	3,500
<b>Total</b>	<b>4,000</b>	<b>6,000</b>	<b>8,000</b>	<b>16,000</b>	<b>34,000</b>
<b>Annual Aircraft Operations</b>					
	<b>(Number of Operations)</b>				
Local	3,000	4,000	5,000	7,000	15,000
Itinerant	1,000	2,000	3,000	9,000	19,000
<b>Total</b>	<b>4,000</b>	<b>6,000</b>	<b>8,000</b>	<b>16,000</b>	<b>34,000</b>

**Table 2-2  
Area Airports  
(Crows Landing Airport Vicinity)**

Airport Name	Owner	Location				Facilities				Services						
		Community/County	Distance/Direction	Based Aircraft	Number of Runways	Longest Runway (ft.)	Surface <sup>2</sup>	Lighted-Intensity <sup>3</sup>	Approach Visibility <sup>4</sup> / Category	Control Tower	Airline Service	AVGas	Jet Fuel	Maintenance	Automobile Rentals	Food
<b>AREA AIRPORTS</b>																
Castle	Merced County	Merced/ Merced	32	76	1	11,802	ASPH/ CONC	H	ILS/LOC/ VOR/DME/ GPS	√	-	√	√	√	-	-
Gustine	City of Gustine	Gustine/ Merced	11	23	1	3,200	ASPH	M	VIS	-	-	√	-	√	-	-
Los Banos	City of Los Banos	Los Banos/ Merced	24	34	1	3,800	ASPH	M	VOR/DME/ GPS	-	-	√	√	√	-	√
Merced Municipal	City of Merced	Merced/ Merced	29	111	1	5,903	ASPH/ POR	H	GPS/ILS/ VOR/DME	-	√	√	√	√	√	√
Modesto City- County	City of Modesto	Modesto/ Stanislaus	17	182	2	5,911	ASPH	M	ILS/LOC/ VOR/DME/ GPS	√	√	√	√	√	-	-
New Jerusalem	City of Tracy	Tracy/ San Joaquin	20	77	1	3,530	ASPH	-	VIS	-	-	-	-	-	-	-
Turlock	City of Turlock	Turlock/ Merced	23	64	1	2,985	ASPH	-	VIS	-	-	√	-	-	-	-
<sup>1</sup> Distance in statute miles from Crows Landing Airport <sup>2</sup> ASPH=asphalt; CONC=concrete; POR=Porous Friction Coat <sup>3</sup> L=low; M=medium; H=high <sup>4</sup> Statute mile NP=Nonprecision; VIS=visual; ILS=Instrument Landing System; LOC=Localizer; VOR=Very High Frequency Omnidirectional Range; DME=Distance Measuring Equipment; GPS=Global Positioning System																



---

**Figure 2A. Representative Aircraft**



**CHAPTER 3**

---

**AIRPORT DEVELOPMENT CONCEPTS**



# AIRPORT DEVELOPMENT CONCEPTS

## INTRODUCTION

Chapter 3 presents a staged development plan for the airfield and building area at the Crows Landing Airport. The staging plan reflects the project development priorities and schedules for three planning periods:

- **At Opening: 0 to 10 Years**
- **Future Development: 11 to 30 Years**
- **Ultimate Build-out Concept: >30 Years**

The focus of this ALP is on providing direction for the appropriate types of facilities necessary for the initial start-up and intermediate development of the Crows Landing Airport during its first 30 years of operation. Recommendations are limited to a basic development framework that emphasizes the airfield requirements and site suitability for various uses (e.g., hangars, internal access roads, navigational aids, etc.). **Table 3-1, Airport Development Concepts**, and **Table 3-2, Airport Design**, which are provided at the end of this chapter, describe the types of facilities envisioned for each of the three planning phases. Conceptual layouts of airport facilities are provided for illustration purposes in **Figures 3A through 3C**.

A detailed layout of most future development (i.e., Short-Term and Long-Term) within the core building area is not included in this report as the siting of these facilities will be driven by demand and other factors (e.g., public road access to the airport, funding, etc.). Follow-up planning and engineering studies will be required to expand upon the basic framework presented in this ALP.

## AIRPORT DEVELOPMENT OVERVIEW

The conceptual development plan for Crows Landing Airport is described below. The factors affecting the siting and development of future airport facilities and the specific design requirements applicable to Crows Landing Airport are discussed in subsequent sections of this chapter.

### At Opening: 0 to 10 Years

Approximately 370 acres of the former Crows Landing Air Facility property will be used for a GA airport. The new Crows Landing Airport will open for public use as a very basic/visual approach, day-use-only general aviation facility that would support Airport Reference Code (ARC) B-II aircraft. A portion of the existing concrete pavement remaining from runways and taxiways at the former Crows Landing Air Facility will be rehabilitated and serve as a new runway/taxiway system and building area.

---

The former northwest/southeast runway (Runway 11-29) will be remarked as a 5,300-foot-long by 100-foot-wide runway. Initially, the runway will be unlighted and available for daytime use only. Visual approach aids will be provided, such as a segmented circle and three unlighted wind socks. The former parallel taxiway system for Runway 11-29 will also be retained, as the separation distance between the runway and parallel taxiway satisfies FAA design standards for an ARC B-II runway and taxiway. Inline (or lead-in) taxiways will provide access to and from the new runway thresholds. Standard right-angle runway entrance taxiways will be provided later as funding becomes available.

A portion of the former north/south runway (Runway 16-34) and apron area located northeast of Runway 11-29 will serve as the airport's core building area. Initial development is anticipated to use existing pavement to the greatest extent practicable. The building area will provide space for a small aircraft parking apron accommodating five aircraft tie-downs and ten hangars, and an airport operations office with restrooms and a telephone. Aircraft hangars are anticipated to be provided by the private sector on property leased from the County. To prevent inadvertent entry to the airport, a perimeter fence will be provided to separate the airport from the adjacent industrial business park development. A manual gate will provide controlled access to the Airport from West Ike Crow Road. To make the airport attractive to new users, aviation gas (100LL) will be provided using a self-service/skid-mounted/above-ground storage tank that would be located on existing pavement near the airport operations office. If required, Jet-A fuel would likely be dispensed by a refueler truck, but jet fuel facilities are likely to occur in subsequent development stages. A wash rack will also be provided. • The future fuel station and wash rack are planned to be located immediately adjacent to one another in an effort to share a common filtration system. The initial planning, design, and operational tasks that must be completed prior to opening the Airport are identified in Chapter 4, Table 4-2.

### **Future Development: 11 to 30 Years**

In this phase of development, minimal structural modifications to the runway/taxiway system are envisioned. The principal change will be the addition of runway lighting and navigational aids, as well as upgraded runway markings to reflect non-precision instrument approach capabilities. It should be noted that a non-precision GPS-based instrument approach does not require on-the-ground support facilities. Lighting and navigational aids include medium-intensity runway edge lights (MIRL), precision approach path indicator (PAPI), runway end identifier lights (REIL), and a rotating beacon. The three wind cones installed during the first five years also will be lighted. A description of these facilities is provided later in this chapter in the discussion of Other Runway Features.

A 3-acre area will be reserved on the southeast side of the airport to provide a heliport facility. Initially, the heliport will include a helicopter takeoff and landing area which will utilize existing airfield pavement. Other support facilities, such as helicopter parking and/or a fixed-base operator (FBO) facility, may require additional pavement depending on the heliport layout and design.

This phase of development also includes the construction of a perimeter access road. Initially, only a segment of the perimeter road would be needed to provide access between the northeast building area and the heliport and perhaps direct access to the heliport from Bell Road. Eventually, as the southwest building area is developed, a complete perimeter road would be advantageous to provide airport tenants, fuel trucks, and airport personnel with uninterrupted passage between the northeast and southwest building areas.

---

Building area development is anticipated to include:

- **New apron to accommodate additional aircraft parking and/or an FBO:** Additional apron pavement will likely be needed to accommodate additional based aircraft (five additional hangars or tie-downs) and/or a FBO facility. The transient tie-down apron located near the operations office can be relocated if a FBO desires to site its facilities on the existing pavement near the airport entrance. If this occurs, the taxiway system would need to be reconfigured. **Figure 3B** reflects this design.
- **Lighting and navigational aids:** Airport lighting facilities are presented in the discussion of Visual Approach Aids that appears later in this chapter.

### **Ultimate Build-out: >30 Years**

The principal change occurring in this phase of development is a proposed runway extension that would lengthen Runway 11-29 from 5,300 feet to 6,300 feet. The runway/taxiway system would be upgraded during this phase to accommodate ARC C-II aircraft, and to provide precision instrument approach capabilities. These upgrades will require:

- Acquiring 202 acres, of which approximately 200 acres are within the existing approach protection easement.
- Constructing a 1,000-foot extension of Runway 11 to the northwest and blast pad.
- Realigning a portion of Davis Road to keep all runway clear areas on airport property.
- Constructing a new parallel taxiway and apron area on the southwest side of the runway to satisfy FAA requirements.
- separation requirements.
- Upgrading the runway markings to reflect precision instrument approach capabilities and installing an approach lighting system(s).
- Relocating and providing additional fencing.
- Providing 90-degree taxiway entrance/exits to the runway ends.
- Relocating all structures that do not satisfy the setback requirements for an ARC C-II runway.

Expansion of the airport building and apron areas is anticipated to accommodate additional based and transient aircraft as well as FBO facilities. Development of the southwest building area and enhancement of the heliport facilities are also anticipated. Details associated with the facility layout will depend on demand and available funding.

## AIRPORT DESIGN FACTORS

The FAA establishes extensive standards pertaining to all aspects of airport design. These standards vary depending upon the characteristics of the critical aircraft anticipated to use the facility regularly and the airport's specific operating conditions (e.g., elevation, average maximum temperature, prevailing wind direction, type of approach).

### Airport Classification and Design Aircraft

FAA airport design standards are set in accordance with an Airport Reference Code (ARC) that may apply to the airport as a whole or Range to an individual runway or taxiway (FAA Advisory Circular 150/5300-13, Airport Design). The primary determinants of ARC classifications are the approach speed and wingspan of the most demanding types of aircraft expected to operate regularly at the airport, together with the type of instrument approach capability associated with the runway.

As described in Chapter 2, Airport Role and Activity Forecasts, the majority of airport operations would be generated by small single-engine, piston aircraft. However, within the short-term planning period, the most demanding class of aircraft expected to use the airport regularly, as defined by the FAA as more than 500 annual operations, is the medium-sized, twin-engine, turbo-prop aircraft, such as the Beechcraft Super King Air B200. Ultimately, the most demanding class of aircraft anticipated to operate at Crows Landing Airport is business/corporate jets.

For facility planning purposes, the following ARCs and design aircraft were used to identify facility needs for the Crows Landing Airport:

- **At Opening** : ARC B-II, Beechcraft Super King Air B200 (103 knots approach speed, 12,500 pounds maximum takeoff weight, 54.5-foot wingspan, 43.8 feet in length).
- **Ultimate Build-out (>30 years)** : ARC C-II, Gulfstream III (136 knots approach speed, 68,700 pounds maximum takeoff weight, 77.8 foot wingspan, 83.1 feet in length).

Airport Reference Code Criteria	
Approach Category	Approach Speed Range
A	<91 kts
B	≥91 kts <121 kts
C	≥121 kts <141kts
D	≥141 kts <161 kts
E	≥166 kts
Design Group	Wingspan Range
I	<49 feet
II	≥49 feet <79 feet
III	≥79 feet <118 feet
IV	≥118 feet <171 feet
V	≥171 feet <214 feet
VI	≥214 feet <262 feet

#### ARC B-II Aircraft Beechcraft Super King Air B-200

Twin-turboprop, seats 6-10, includes most business/corporate turboprop aircraft.



#### ARC C-II Aircraft Gulfstream III

Business jet/medium cabin, seats 4-10, includes commercial regional jet aircraft.





---

## Wind Coverage

Strong winds at an airport can pose airfield and building design concerns. Wind conditions affect all airplanes in varying degrees. Generally, the smaller the airplane, the more it is affected by wind, particularly crosswind components.

Ideally, a runway should be aligned with the prevailing wind to allow a pilot to land and takeoff into the wind. FAA guidelines establish that the orientation of an airport's runways should enable the airport to be usable, with crosswinds at an acceptable velocity, during at least 95% of the year. Airports with lower annual wind coverage can qualify for FAA funding to construct a crosswind runway. The criteria for an acceptable crosswind velocity are tied to the runway's ARC and to the type of aircraft using the runway. Small, light aircraft are more affected by strong crosswinds than larger, heavier planes. For small planes, the FAA considers a 10.5 knot crosswind to be the maximum acceptable, whereas heavy jets can tolerate crosswinds up to 20 knots.

In terms of design aircraft parking aprons, aircraft operators generally prefer to park their aircraft nose-forward into the wind. Aircraft pointed into the wind are far less likely to suffer control surface damage from wind gusts (i.e., gusts striking the aircraft from the sides or the rear are capable of overstressing/bending critical aircraft control surfaces). Other advantages include faster cooling down of aircraft engines and preventing engine fumes from entering the cabin.

*A **Wind Rose** is a meteorological diagram depicting the distribution of **wind** direction and speed at a specific location over a period of time.*

***Visual flight rules (VFR)** are a set of aviation regulations under which a pilot may operate an aircraft, if weather conditions are sufficient to allow the pilot to visually control the aircraft's attitude, navigate, and maintain separation with obstacles such as terrain and other aircraft.*

***Instrument flight rules (IFR)** are a set of regulations and procedures for flying aircraft without the assumption that pilots will be able to see and avoid obstacles, terrain, and other air traffic; it is an alternative to visual flight rules (VFR), where the pilot is primarily or exclusively responsible for see-and-avoid.*

## RUNWAY DESIGN

The basic design factors and requirements associated with an airport runway system are described in the following paragraphs. The airfield design features for each development phase associated with the Crows Landing Airport are summarized in **Table 3-2**.

### Runway Configuration

The former Crows Landing Air Facility had two intersecting runways: Runway 16-34, which was aligned in a north/south direction, and Runway 11-29, which was oriented in a northwest/southeast direction. In 2006, the County decided to retain Runway 11-29 for its new GA airport. The concrete runway associated with the former Crows Landing Air Facility is sufficient to accommodate the load-bearing weight of ARC B-II and C-II aircraft envisioned to use the new Crows Landing Airport. The runway is in usable condition, but weed removal, crack filling, and marking are necessary. The surfaces are reasonably smooth with some uniform unevenness over the entire surface, but no serious dips or humps are present. Concrete damage is restricted to cracking at the corners of relatively few slabs. Runway 11-29 is aligned with the prevailing wind direction from the northwest.

## Runway Length

The length of the runway required to accommodate the most demanding airplanes anticipated to use the airport is a fundamental factor of airfield design. Runway length requirements for specific aircraft depend upon the airfield elevation and design temperature (the average high temperature for the hottest month). For several categories of small aircraft, the FAA has established formulas to identify the desirable runway length. For large aircraft, this data is available in performance charts provided by aircraft manufacturers.

The Crows Landing Airport is located in the northwestern part of the San Joaquin Valley at an elevation of 156 feet above mean sea level (MSL). The Airport is situated approximately 10 miles east of the Diablo Range and 80 miles east of the Sierra Nevada Foothills. The mean maximum temperature of the hottest month (July) is 96.6 degrees Fahrenheit.<sup>1</sup> Based on this data, the FAA's program indicates that a runway length of less than 5,000 feet would be sufficient to accommodate all small aircraft weighing less than 12,500 pounds. Larger, heavier aircraft (>12,500 pounds.) would require a longer runway. The specific runway length requirements for Crows Landing Airport are:

- **At Opening through Year 30:** runway length is 5,175 feet
  - Length is suitable to accommodate all small general aviation aircraft and some use by large aircraft; and
  - All runway critical areas (runway safety and objected free areas) remain on airport property.
- **Ultimate Build-out (>30 years):** runway length is 6,175 feet
  - Length is sufficient to accommodate most of the small-to-medium sized business jets within in ARC C-II.
  - The acquisition of 202 acres off the ends of the runway and the realignment of a portion of Davis Road and Bell Road will be necessary to allow the runway critical areas to remain on airport property and under County control.

## Runway Width

FAA runway width design standards consider both the airport's ARC designation and the visibility conditions under which aircraft operate (visual, visibility minimums of  $< \frac{3}{4}$  statute mile). Generally, fast-moving aircraft operating during reduced visibility conditions require wide runways to ensure that sufficient hard surface is available for safe landing and takeoff. The runway width design standards for ARC B-II and C-II are presented in the Runway Width Criteria table.

Runway Width Criteria		
Visibility*	ARC B-II	ARC C-II
Visual or $\geq \frac{3}{4}$ mile	75	100
$< \frac{3}{4}$ mile	100	100
* Visibility minimums in statute miles		

For the Crows Landing Airport, the runway width is designed at 100 feet as existing runway pavement from the former Crows Landing Air Facility is available and in good condition. This runway width surpasses the minimum FAA requirements for ARC B-11 aircraft, which are anticipated to use the airport during its first ten years of operation.

<sup>1</sup> Western Regional Climate Center - for Newman Station 8 miles south

---

## Runway Safety Areas

Runway Safety Areas (RSAs) are graded areas situated along the sides and ends of runways. RSAs must be clear of objects, except those that must be located near the runway because of their aeronautical function. Under dry conditions, the area must be capable of supporting emergency equipment and the occasional passage of an aircraft without causing structural damage to the aircraft. Consistent with FAA design standards, the RSA for Crows Landing Airport is:

- **At Opening and Future Development:** 150 feet wide and 300 feet beyond the runway ends
- **Ultimate Build-out:** 500 feet wide and 1,000 feet beyond the runway ends

## Object Free Areas

Object Free Areas (OFAs) also surround runways and must be clear of nonessential objects including parked airplanes. The major difference between these two critical areas is that the grading criteria for RSAs do not apply to OFAs. For example, ditches can be located in an OFA. Also, aircraft may taxi or hold within an OFA, but not an RSA. The length of the OFA beyond the ends of the runway is identical to the requirements of an RSA or can be extended to the end of the runway protection zone. The OFA width, however, is based on the airport's ARC designation and approach visibility minimums. The OFA width dimensions applicable to Crows Landing Airport are presented in the adjacent table.

Object Free Area (OFA) Width		
Visibility*	ARC B-II	ARC C-II
Visual or ≥ 3/4 mile	500'	800'
< 3/4 mile	800'	800'
* <i>Visibility minimums in statute miles</i>		

## Obstacle Free Zones

A third critical area surrounding a runway is the Obstacle Free Zone (OFZ). OFZs are three-dimensional—consequently, short objects may be acceptable in places where taller objects may not be acceptable. Only frangible, mounted navigational aids are allowed to penetrate an OFZ. Other objects, including taxiing or parked airplanes, are not permitted. Consistent with FAA standards, the OFZ for Crows Landing Airport is 400 feet wide and extends 200 feet beyond the ends of the runway for all three development phases.

## Runway Protection Zone

A runway protection zone (RPZ) is a trapezoidal area beginning 200 feet beyond the end of the runway. The purpose of the RPZ is to enhance the protection of people and property on the ground, and this is achieved when the airport owner maintains control over land within its RPZs. Such control includes clearing and maintaining RPZ areas to be free of incompatible objects and activities.

Control over the RPZ is best exercised through the acquisition of sufficient property interests in the RPZ. The RPZ dimension is a function of the type of aircraft and approach visibility minimum associated with that runway end. Consistent with FAA design standards, the RPZ dimensions for Crows Landing Airport are:

- 
- **At Opening and Future Development:** 250 feet inner width, 450 feet outer width, and 1,000 feet in length
  - **Ultimate Build-out:** 1,000 feet inner width, 1,750 feet outer width, and 2,500 feet in length

### **Building Restriction Line**

The building restriction line (BRL) establishes the closest location in which buildings can be placed relative to a nearby runway or, in some cases, a primary taxiway. The FAA no longer defines a specific BRL setback distance standard, but it provides guidance on factors to be considered in determining the BRL location.

The location of the BRL is determined in large part by the necessary setback distances from the runway and taxiway system. An additional consideration is the need to provide sufficient vertical clearance over fixed or movable objects (e.g., buildings, parked or taxiing aircraft). Vertical clearance requirements are established in accordance to Federal Aviation Regulations (FAR) Part 77, *Safe, Efficient Use and Preservation of the Navigable Airspace*, which identifies the airspace necessary for navigation. The airspace requirements applicable to Crows Landing Airport are provided in Chapter 4, *Airport Plans*.

For the Crows Landing Airport, the BRLS were established to accommodate anticipated development during the three development phases (Opening, Short-term, and Long-Range). The primary building area, which will accommodate initial airport development, is located northeast of Runway 11L-29R.

- **At Opening and Future Development (0 to 30 years):**
  - BRL B-II: 15-foot vertical clearance is located 355 feet from the runway centerline
  - BRL B-II: 30-foot vertical clearance is located 460 from the runway centerline
- **Ultimate Build-out (>30 years):**
  - BRL C-II: 15-foot vertical clearance is located 605 feet from the runway centerline
  - BRL C-II: 30-foot vertical clearance is located 710 from the runway centerline

To minimize the future expense of relocating structures, permanent airport facilities (e.g., buildings, fueling facility) should be located in the areas farthest from the runway to meet ARC C-II setback requirements. Temporary objects or semi-permanent structures (e.g., portable hangars, tiedown aprons) are suitable for the areas defined by the BRLs for ARC B-II.

---

## Other Runway Features

### Blast Pads

Blast pads consist of light-duty pavement situated beyond the ends of runways. They serve to minimize erosion and the blowing of dirt and debris from unprotected ground that result when aircraft, particularly jets, apply full power to initiate takeoff. Although paved, blast pads are not usable by aircraft under normal circumstances and are not included in the runway length.

In the early phases of development, blast pads are not needed as minimal jet activity is anticipated. Once the runway is upgraded to an ARC C-II facility, the existing concrete pavement leading up to the Runway 29R threshold would be marked as a blast pad. New blast pads would be constructed at the other runway ends during the Long-Range development phase.

### Marking

The pavement remaining from the Crows Landing Air Facility is more extensive than what is needed for the new general aviation facility. Therefore, together with the pavement resurfacing, the new runway threshold bars, chevrons, edge striping, and shoulder marking will serve to delineate the reduced length and width of the runway. The runway marking will be upgraded as instrument approaches capabilities are provided (e.g., non-precision and precision). Figures 3A through 3C reflect the following different runway marking standards:

- **At Opening (Year 0 to 10):** Basic runway markings reflecting a runway with no straight-in instrument approach procedures.
- **Future Development (Years 11 to 30):** Non-precision runway markings reflecting straight-in instrument approach procedures providing horizontal guidance only.
- **Ultimate Build-out (>30 Years):** Precision runway markings reflecting straight-in instrument approach procedures providing horizontal and vertical guidance.

### Visual Approach Aids

The visual approach aids described below are envisioned for development at the Crows Landing Airport after the first ten years of operation as demand warrants.

- **Runway edge lights.** Runway edge lighting is designed to show the width and length of the usable landing area; there are two rows of lights—one row on each side of the runway—that extend along the length of the runway. These light systems are classified according to the intensity they are capable of producing. For the Crows Landing Airport, Medium Intensity Runway Lights (MIRL) or High Intensity Runway Lights (HIRL) are anticipated. These lights can be part of a Pilot-Controlled Lighting (PLC) system, which allows a pilot to turn on an airport's runway edge, approach, and taxiway lights via radio. PLC systems are most common at non-towered or infrequently used airfields where it is not economical to light the runways all night or to provide staff to turn the lights on and off.
- **Precision Approach Path Indicator (PAPI).** A lighting system positioned beside the runway that consists of two, three, or four boxes of lights to provide a visual indication of an aircraft's position on the glidepath for the associated runway. The PAPI is usually located on the left side of the runway

---

and can be seen from distances of up to 5 miles during the day and 20 miles at night.

- **Approach Lighting System (ALS).** A lighting system installed on the approach end of an airport runway that consists of a series of lightbars, strobe lights, or a combination of the two, and extends outward from the runway end. An ALS usually serves a runway that has an associated instrument approach procedure (IAP), upon arrival and it allows the pilot to visually identify the runway environment upon arrival at a prescribed point on an approach. A medium- intensity approach lighting system with runway alignment indicator lights (MALSR) is proposed for Crows Landing Airport. The light bars, spaced 200 feet apart, extend outward to a distance of 2,400 feet from the runway ends.
- **Runway end identifier lights (REIL).** Lights installed at many airports to provide rapid and positive identification of the approach end of a particular runway. The system consists of a pair of synchronized flashing lights located laterally on each side of the runway threshold.
- **Rotating Beacon.** A device used to assist pilots in finding an airport, particularly those flying in visual flight rules (VFR) at night. A standard green-and-white rotating beacon is proposed for construction near the airport's entrance during the short term.
- **Wind indicator.** A windsock or wind cone is a conical textile tube designated to indicate wind direction and relative wind speed. Per FAA standards (FAA Advisory Circular 150/5345-27D), a 15-knot (17-mph) wind will fully extend the windsock. A 3-knot (3.5-mph) breeze will cause the windsock to orient itself according to the wind. At many airports windsocks are lighted at night, either by flood lights on top surrounding it or with one pole-mounted light that shines inside the wind sock.

Three unlighted wind cones will be provided initially at the Crows Landing Airport as the airport will be used only during the day. The primary wind cone is collocated with the segmented circle at midfield. Two others are found near the approach ends of Runways 11 and 29. Lighted wind cones will be provided when runway lighting becomes available.

- **Segmented circle.** A segmented circle is used to aid pilots determine takeoff and landing information at an airport. The optimum location for the segmented circle is midfield. This centralized location enables pilots to locate the segmented circle easily.

## Electronic Navigational Aids

Electronic navigational aids (NAVAIDs), in particular instrument approach aids, are an important operational element of any public-use airport. NAVAIDs facilitate user access to and from the airport during inclement weather conditions. To be fully effective, the NAVAIDs must be complemented by airfield improvements such as an appropriate runway lighting system, runway markings, and signing. It is anticipated that the Crows Landing Airport will initially open for public-use with a basic GPS-based Non-Precision Instrument Approach (NPIA) serving each of the two runway ends. Such NPIAs would likely have approach minimums of 1 statute mile visibility and a 400-foot ceiling. As the Airport and its airfield components are expanded and improved, it is anticipated that the Airport's runway will be served by multiple GPS-based Precision Instrument Approaches (PIA) with approach minimums of ½ statute mile visibility and a 200-foot ceiling.

*Global Positioning System. A system of satellites that allows one's position to be calculated with great accuracy by the use of an electronic receiver.*

## TAXIWAYS

Taxiways provide the links by which aircraft travel between runways and parking facilities in the airport building area. At the Crows Landing Airport, this system will consist of major taxiways parallel to the runway and with various secondary taxiways to provide access to parking aprons and hangar areas.

### Taxiway Design

In the early phases of development (At Opening and Short-Term), the taxiway system will utilize the pavement remaining from the former Crows Landing Air Facility. The taxiways will be centered on the existing pavement and marked to reflect a 35-foot wide taxiway, consistent with FAA design standards for ARC B-II and C-II runways. Hold lines, as required by FAA standards, will be marked on each exit taxiway which intersects with the runway. The hold lines will be marked 200 feet from the runway centerline, consistent with the standards applicable to an ARC B-II runway. The hold line will be remarked 250 feet from the centerline once the runway is upgraded to an ARC C-II facility or precision instrument approach capabilities are provided (i.e., <3/4 statute mile visibility). The future taxiways can be equipped with medium-intensity taxiway lighting and/or reflectors at the same time the runway lighting is installed.

Taxiway Hold Line Distance		
Visibility*	ARC B-II	ARC C-II
Visual or ≥ 3/4 mile	200'	250'
< 3/4 mile	250'	250'
* Visibility minimums in statute miles		

### Taxiway Designations

Taxiways are generally labeled with letters of the alphabet in accordance with criteria outlined in FAA Advisory Circular 150/5340-18C, Standards for Airport Sign Systems. The parallel taxiway along the northeast side of Runway 11-29 and the exit taxiway serving the approach end of Runway 29 will be designated Taxiway A. The four 90-degree exit taxiways angling from the middle section of Runway 11-29 will be designated A1, A2, A3, and A4 as they progress southward.

---

## Runway-to-Taxiway Separation

For runways classified as ARC B-II, the FAA standard for runway-to-parallel taxiway separation is 240 feet. Based on this alignment, the separation distance between the runway and taxiway is 288 feet. When either the Airport's instrument approach capabilities or ARC classification is upgraded, the separation distance will need to increase to meet the FAA's design standards noted in the adjacent table.

Runway-to-Taxiway Separation		
Visibility*	ARC B-II	ARC C-II
Visual or $\geq 3/4$ mile	240'	300'
$< 3/4$ mile	300'	400'
* Visibility minimums in statute miles		

## Taxiway Object Free Area

Similar to the runway object free area (OFA), the taxiway OFA clearing standards prohibit service vehicle roads, parked airplanes, and aboveground objects, except those needed for air navigation or ground maneuvering. In combination with meeting FAR Part 77 requirements, the taxiway OFA is often used to establish the Aircraft Parking Limit (APL) line. APLs define the areas which are appropriate for parking of aircraft.

As designed, the distance from the centerline of Taxiway A to adjacent aircraft parking positions is approximately 67 feet. This amount of wingtip clearance is ample for the anticipated mix of aircraft using the airport. It meets FAA standards for ARC B-II and C-II aircraft (i.e., aircraft with wingspans up to 79 feet, such as a Gulfstream III).

## Signage

FAA standards for airfield signage are set forth in Advisory Circular 150/5340-18C, *Standards for Airport Sign Systems*. These standards mandate the installation of certain instructional signs at all airports. Other types of signs provide guidance to pilots (e.g., signs that show the designation of or direction to runways and taxiways). All signs on lighted runways or taxiways should be lighted.

For the Crows Landing Airport, the only applicable signs considered mandated for airport safety are the Holding Position signs at taxiway intersections with runways. A sign plan should be prepared for the airport, and all signs required or recommended by the FAA should be installed once the airport is upgraded to an ARC C-II facility. An entrance sign should also be installed near the airport operations office or entrance gate.



---

## Helicopter Takeoff and Landing Area

Initially, in lieu of a formal heliport, helicopters are expected to use the runway for landing and takeoff, then hover /taxi to a parking place, or, under good-visibility, daylight conditions, may fly directly to where they intend to park. As helicopter demand increases, a formal takeoff and landing area with appurtenant parking positions can be established. A suitable helicopter parking area would be on the southern-most end of the former Runway 34. Helicopter parking could also utilize existing concrete pavement. The precise location will depend upon the ultimate location of future development on the airport's south side. In general, approximately 3 acres of land will be necessary to accommodate a heliport (i.e., formal takeoff and landing area, helicopter parking spaces, required clear areas, FBO building, and associated automobile parking). An access road to the facility will also be required.

## Building Area Design Factors

The building area of an airport encompasses all of the airport property not devoted to runways, major taxiways, required clear areas, and other airfield-related functions. Common uses of building area land at general aviation airports similar to that anticipated at Crows Landing Airport are listed in the box to the right.

Many types of airport facilities have similar functions and needs, and it is efficient to group similar uses together. For example, high-intensity uses such as corporate hangars and aviation-related businesses, which serve transient aircraft as well as the public, require good visibility from the roads, direct public access, and runway access. Conversely, low-intensity uses such as the smaller aircraft storage hangars (e.g., T-hangars and box hangars) require good runway access. These hangar areas are typically restricted areas with controlled gated-access.

Numerous facilities are essential to the accommodation of future demands for aviation-related use of the airport building area. This ALP identifies the suitable locations and general configurations for future building area development and aviation uses. The precise location and type of facilities will be based on demand and specific facility needs (e.g., convenient road access, large FBO hangar). More detailed designs will be required before construction can begin. The discussion that follows provides a general description of the types of facilities that could be sited at Crows Landing Airport.

## Aircraft Hangars

As is the case at most general aviation airports, it is anticipated that the demand for aircraft parking space at Crows Landing Airport will be primarily for hangars. Aircraft storage hangars can be grouped into five general categories:

### Typical Building Area Functions at General Aviation Airports

#### Commonly Found Facilities:

- *Based aircraft tie-downs and storage hangars*
- *Transient aircraft parking*
- *Administration building or airport office*
- *Pilots' lounge / flight preparation room*
- *Public rest rooms / public telephones*
- *Fixed-base operations facilities*
- *Fuel storage and dispensing equipment*
- *Aircraft washing area (wash rack)*
- *Security/perimeter fencing and access gates*
- *Access roads and automobile parking*

#### Other Facilities Common at Larger Airports:

- *Corporate aircraft storage hangars and offices*
- *Air traffic control tower*
- *Emergency response equipment and storage facility*
- *Coffee shop or restaurant*
- *Rental car facilities*
- *Air freight handling facilities*
- *Commercial/industrial buildings*

- **T-Hangars** – T-hangars are the most common form of aircraft storage at general aviation airports. The back-to-back arrangement of the individual T-shaped bays is efficient from a structure-size standpoint, but requires taxiway access on both sides of the building. For reasonable economy of construction, T-hangar buildings preferably should contain at least 10 aircraft bays.
- **Rectangular –Executive Hangars** – Rectangular-shaped hangar units are well suited to locations where access is practical to only one side of the building. The hangar bays are larger than typical T-hangar units and usually are designed to accommodate twin-engine airplanes or small business jets. Alternatively, they may be used for storage of two or three smaller aircraft. The buildings may consist of either single or multiple bays. Some executive hangars may include small attached office areas.
- **Conventional Corporate Hangars** – Corporate hangars are large, free-standing structures intended to house large business jets or multiple smaller aircraft. A size of 100 square feet is common at many general aviation airports, although the size of the buildings can vary. Office and pilots' lounge areas typically are attached. Corporate hangars usually have an adjacent parking area that vehicles can access without passing through a security gate.
- **Shade Hangars**—Shade hangars are similar to T-hangars, but they do not include doors or interior partitions. They help keep the sun and rain off the aircraft, but they do not provide the security afforded by an enclosed T-hangar. Shade hangars can be constructed advantageously on existing apron pavement in that water drainage through the building is not a concern. Compared to T-hangar construction for which existing pavement must be removed and the site regraded, shade hangars may cost only half as much. On raw ground, the price between the two types differs by only 20%. Shade hangars can be optimal in locations where the mass of an enclosed building would act as a visual barrier.
- **Individual Portable Hangars**—Portables are small, individual hangars designed to be constructed elsewhere and hauled to the airport. They typically are T-shaped, but can be rectangular. An advantage of portables is that they can be added economically in increments of just one unit at a time. However, the cost per unit is similar to, or even higher than, the cost of an individual unit in a multiple-unit T-hangar



**T-Hangar**



**Executive Hangar**



**Corporate Hangar**



**Shade Hangar**



**Portable Hangar**

building. Most often they are owned individually rather than by the airport or a hangar developer. Portables can be installed almost anywhere on the airport, including on existing apron pavement or on unpaved areas. A chief disadvantage is that their inconsistency of appearance. Poor maintenance can make them unattractive.

### Aircraft Apron

Airports need paved apron areas for parking the portion of their based aircraft fleet that is not hangared, as well as for short-term usage by transient aircraft visiting the airport.



#### Tiedown Apron

*Spaces for based and smaller transient aircraft are normally equipped with tiedown anchors and chains or ropes to prevent the aircraft from being battered by strong winds.*

Initially, portions of the former Crows Landing Air Facility apron will be used for aircraft parking. There is sufficient space to accommodate approximately five tie-down positions, which would accommodate demand through the intermediate phase of development (see **Table 3-2**). Additional tie-down aprons will be required to accommodate future increased numbers of based and transient aircraft.

### Airport Operations Office

An administration building should be centrally located with good access both to the transient aircraft apron and to automobile parking. Many GA airports have an administration building that houses not only the airport management offices, but also a pilots' lounge, rest rooms, and other facilities for pilots and the public. Sometimes a coffee shop or restaurant is included. In the future, a multi-function administration building may be necessary. To draw more transient activity, attractive facilities for pilots and other visitors and provision of a meeting area would be advantageous.

Initially, a small, modular building can be used for airport offices located near the entrance to Crows Landing Airport. This location affords good views of the runway, parking aprons, and self-fueling facility, as well as convenient public access. The modular building can be initially sited on the existing concrete pavement.

### Fixed-Base Operations Facilities

Fixed-base operators (FBO) constitute the commercial side of general aviation business. They provide a wide variety of facilities and services for pilots and their aircraft (see adjacent box). Busy airports usually have multiple FBOs, while smaller ones may have one or none. The primary FBOs at an airport commonly offer many of these facilities and services; specialized FBOs may supply just one. Also, at many airports, the airport operator provides some or all of the hangar facilities and fueling services. FBOs often develop and own their facilities on land leased from the airport, but in many cases both the facilities and the land are leased. Primary FBOs should be situated where they are easily visible and accessible both from the airport's airside and from adjacent roads. Specialty FBO sites can be sited in more isolated locations, although vehicle access without the need to go through a security gate is desirable.

#### Examples of FBO Facilities and Services

- Aircraft rental and charter
- Flighting instruction
- Flight preparation room, pilots' lounge and rest rooms
- Pilots' supplies
- Aircraft and avionics maintenance and repair
- Aircraft fueling

---

Sufficient space in the northeast and southwest building areas is available to accommodate establishment of future FBO facilities. The primary constraint is providing sufficient public access and utilities to these areas. Initial FBO development is anticipated near the airport's entrance in the northeast building area.

## Other Support Facilities

- **Aircraft Fueling Facilities**—Fuel can be stored in aboveground tanks and/or dispensed by truck. The ability for small aircraft to obtain fuel at self-service pumps with 24-hour, credit-card-type access is desirable. For larger aircraft, especially for turbine-powered aircraft, fuel delivered by truck is desirable. As airport activity increases, a site near the transient parking apron may be needed (see **Figure 3B**).
- **Aircraft Wash Rack**—Construction of a pollution control facility (e.g., wash rack) may be considered. Siting the wash rack and fueling facility in close proximity of each other would enable sharing of a filtration system. The pollution control facility should be designed to meet current state and local standards to control pollutants from aircraft washing.
- **Air Traffic Control Tower**—The projected activity during the 20-year planning horizon is below the volume at which establishment of an air traffic control tower at the airport is warranted.
- **Airport Fire Station**—Fire protection at the airport is anticipated to be provided by the West Stanislaus Fire Department located in the City of Patterson and on-site fire extinguishers. FAA would not require an on-site firefighting facility during the planning horizon.

## Safety and Security

### Fencing and Gates

The principal form of security at most GA airports is a perimeter fence and controlled-access gates. For safety and security purposes, fencing should keep unauthorized individuals and especially vehicles from accessing the aircraft operating areas and building area. Entry should be possible only with an access code, card, or remote control or by passing through a monitored area such as the airport administration building or a fixed-based operations facility. Determining appropriate locations for fencing and gates in an airport building area can be complex in that public access to certain facilities needs to be maintained.

In May of 2004, the Transportation Security Administration, in conjunction with a wide group of general aviation industry representatives, developed and disseminated a series of security recommendations for consideration by general aviation airport operators, tenants, and users entitled Security Guidelines for General Aviation Airports (IP A-001). These recommendations, while not regulatory, should be carefully considered for application at Crows Landing Airport.

A perimeter fence will be provided during the initial phase of development. Perimeter fencing at the Crows Landing Airport would initially be located along Davis and Bell roads, as well as around the airport's entrance to the core building area. As airport activity increases and growth occurs in the adjacent industrial business park, the remainder of the airport property will need to be enclosed. Additional fencing will be needed in the long term in conjunction with airfield expansion and the acquisition of additional property.

---

## Utilities

The utility lines to the former Crows Landing Air Facility (e.g., water and sewer, electricity, gas and telephone hook-up) will be provided as part of the Crows Landing Business Park Development and extended onto the airport site. Capacity is not assumed to pose a problem for most of the potential aviation uses.

## Drainage

The topography at the Crows Landing Airport is very flat. Once the property on the northeast side of the airfield is developed with impervious parking and building areas, additional drainage facilities will be necessary. Grading of the northeast building area will need to provide positive drainage flows to maintain and formalize the general drainage patterns currently existing on the airport. While drainage will need to be considered in the engineering designs of the north-side facilities, it is not a significant layout planning consideration. At some point in the future, it may prove advantageous to prepare a Storm Water Drainage Master Plan to address the long-term drainage development needs of the airport.

## Road Access

Good road access and visibility from adjacent roads are important marketing factors for most businesses that serve local pilots and the general public.

- **Internal Service Road**—An internal service road is needed to enable vehicles to travel around the airport without entering the controlled aircraft movement area and allow them to get from one part of the airport to another without using public roads or passing through gates. The service road is not open to the general public, only to airport vehicles, hangar tenants, and others authorized to pass through a controlled-access gate. These features are a time-saving convenience. In addition, the ability to remain off the public roads is particularly important for fuel trucks in that these vehicles normally are not licensed and insured for driving on public roads. Providing continuous vehicular access between the northeast and southwest building areas will require going around the ends of the runway. An internal service road for the Crows Landing Airport is proposed to follow the airport property to ensure clearance of critical airfield safety areas (RSA, OFA). However, internal service roads may not be necessary in all areas depending on the layout of new development on the northeast side. The internal access road is anticipated to accommodate the fuel trucks, hangar tenants, and other authorized vehicles. Thus, the load bearing capacity of the future service road pavement will need to be capable of handling the weight of the fuel trucks.
- **External Road Access**— Convenient access from the adjacent major roads is essential to aviation-related businesses located at the airport. Corporate hangars also need to be accessible without the need for visitors to pass through a controlled-access gate. The difficulty of providing a good external road access to the interior area of the north-side property is a significant constraint to the options for development of the site. Therefore, the layout of airport facilities will depend largely upon on the external road network.

Table 3-1

**Airport Development Concepts  
Crows Landing Airport**

Phase	Development Concepts
<p><b>At Opening (0 to 10 Years)</b></p>	<p><b>Airport Reference Code B-II</b></p> <ul style="list-style-type: none"> <li>▪ One Portland cement concrete runway: Runway 11-29 (5,175' x 100')</li> <li>▪ Full-length parallel taxiway on northeast side</li> <li>▪ Unlighted runway –daytime use, visual flight rules (VFR) only</li> <li>▪ Small airport operations office (e.g., modular unit) on existing concrete pavement</li> <li>▪ Small aircraft parking apron with 5 tiedowns on existing concrete pavement fronting operations office</li> <li>▪ Up to 10 privately financed hangars on County leases sited on existing concrete pavement</li> <li>▪ All aeronautical support facilities to be sited on northeast side of Runway 11-29 (e.g., aprons, hangars)</li> <li>▪ Perimeter fencing along Davis and Bell Roads and apron area</li> <li>▪ Basic aviation fuel services: 100LL via self-service from a skid-mount tank and maybe Jet-A via a refueler truck</li> <li>▪ Wash rack facility, perhaps combined with fueling facility to allow sharing of filtration system</li> <li>▪ Modular unit with telephones/wifi and restrooms</li> </ul>
<p><b>Future (11 to 30 Years)</b></p>	<p><b>Airport Reference Code B-II</b></p> <ul style="list-style-type: none"> <li>▪ One Portland cement concrete runway: Runway 11-29 (5,175 x 100')</li> <li>▪ Full-length parallel taxiway on northeast side</li> <li>▪ Medium intensity runway lights, PAPI, rotating beacon</li> <li>▪ Nonprecision instrument approach capability (GPS based)</li> <li>▪ Basic Fixed Base Operator (FBO) services: on-site presence, basic aircraft maintenance, and maybe an FBO hangar, little or no flight training by FBO anticipated</li> <li>▪ Small terminal building to replace modular unit (passenger waiting area, phone, restrooms, operations office), perhaps combined with FBO facilities</li> <li>▪ Basic helicopter takeoff and landing area using existing hard-surface area southwest of Runway 11-29 may be acceptable</li> <li>▪ Perimeter access road and perimeter fencing fully enclosing airport property</li> <li>▪ Additional privately-developed aircraft storage hangars</li> </ul>
<p><b>Ultimate (&gt;30 Years)</b></p>	<p><b>Airport Reference Code C-II</b></p> <ul style="list-style-type: none"> <li>▪ One Portland cement concrete runway: Runway 11-29 (6,175' x 100')</li> <li>▪ New full-length parallel taxiway on northeast side of Runway 11-29 satisfying ARC C-II standards</li> <li>▪ Precision (GPS-based) instrument approach capability</li> <li>▪ Aviation fuel services/jet fuel</li> <li>▪ Additional Fixed Base Operator services (e.g., specialty aeronautical services; some flight training)</li> <li>▪ Enhanced heliport facility (e.g., takeoff and landing area, helicopter parking, FBO facility)</li> <li>▪ Begin development of aeronautical support facilities (e.g., aprons, tied-owns, hangars) on southwest building area</li> </ul>

Table 3-2			
Airport Design Standards Crows Landing Airport			
Airfield Element	At Opening (0 to 10 years)	Future (11 to 30 years)	Ultimate Build-out (>30 years)
Airport Property (acres)	370	No Change	592
Airport Reference Code (ARC)	B-II	No Change	C-II
Runway Design	At Opening	Future	Ultimate Build-out
Runway Length	5,175'	No Change	6,175'
No. of Runways	1	No Change	No Change
Runway Safety Area (RSA) Length Beyond Runway End	300'	No Change	1,000'
Runway Safety Area Width	150'	No Change	500'
Object Free Zone (OFZ) Width	400'	No Change	No Change
Object Free Area (OFA) Width	500	No Change	800
Runway Protection Zone (RPZ) (inner width, outer width, length)	250' x 400' x 1,000'	No Change	1,000' x 1,750' x 2,500'
Runway markings	Basic	Non-precision	Precision
Approach and Landing Aids	At Opening	Future	Ultimate Build-out
Approach Type	Visual	Non-precision (GPS-based)	Precision (GPS-based)
Approach Slope <sup>1</sup>	20:1	34:1	50:1
Primary Surface Width <sup>1</sup>	250'	500'	1,000'
Runway Lighting	None	MIRL/REIL <sup>2</sup>	No Change
Approach Lights	None	None	MALSR <sup>2</sup>
NAVAIDS <sup>2</sup>	Segmented circle, unlit wind cones	Segmented circle, Lighted wind cones, Rotating Beacon, PAPI <sup>2</sup>	No Change

Table 3-2,  
continued

**Airport Design Standards**

Taxiway Design	At Opening	Future	Ultimate Buildout
No of parallel Taxiways (standard taxiway width)	1 (35')	No Change	1 <sup>3</sup> (35')
Taxiway Separation Distance <sup>4</sup>	288'	No Change	400'
Taxiway Hold Line Distance <sup>4</sup>	200'	No Change	250'
Other Design Factors	At Opening	Future	Ultimate Buildout
Building Restriction Line <sup>5</sup>	B-II:15' and 30'	No Change	C-II: 15' and 30'
Airplane Parking Line <sup>6</sup>	66'	No Change	No Change
Hangar Units	15	35	65
Tie-down Spaces	5	No Change	No Change
Based Aircraft	20	40	80
Heliport	None	70' x 70'	No Change

**Notes**

<sup>1</sup> Consistent with criteria established in Federal Aviation Regulation (FAR) Part 77, *Safe and Efficient Use of Navigable Airspace*.

<sup>2</sup> Definitions: Medium Intensity Runway Lights (MIRL); Runway end identifier lights (REIL); Navigational Aids (NAVAIDs); Precision Approach Path Indicator (PAPI); Medium-Intensity Approach Lighting System with Runway Alignment Indicator Lights (MALSR)

<sup>3</sup> A new parallel taxiway to be constructed to meet FAA separation standards for ARC C-II runways

<sup>4</sup> Distance measured from runway centerline

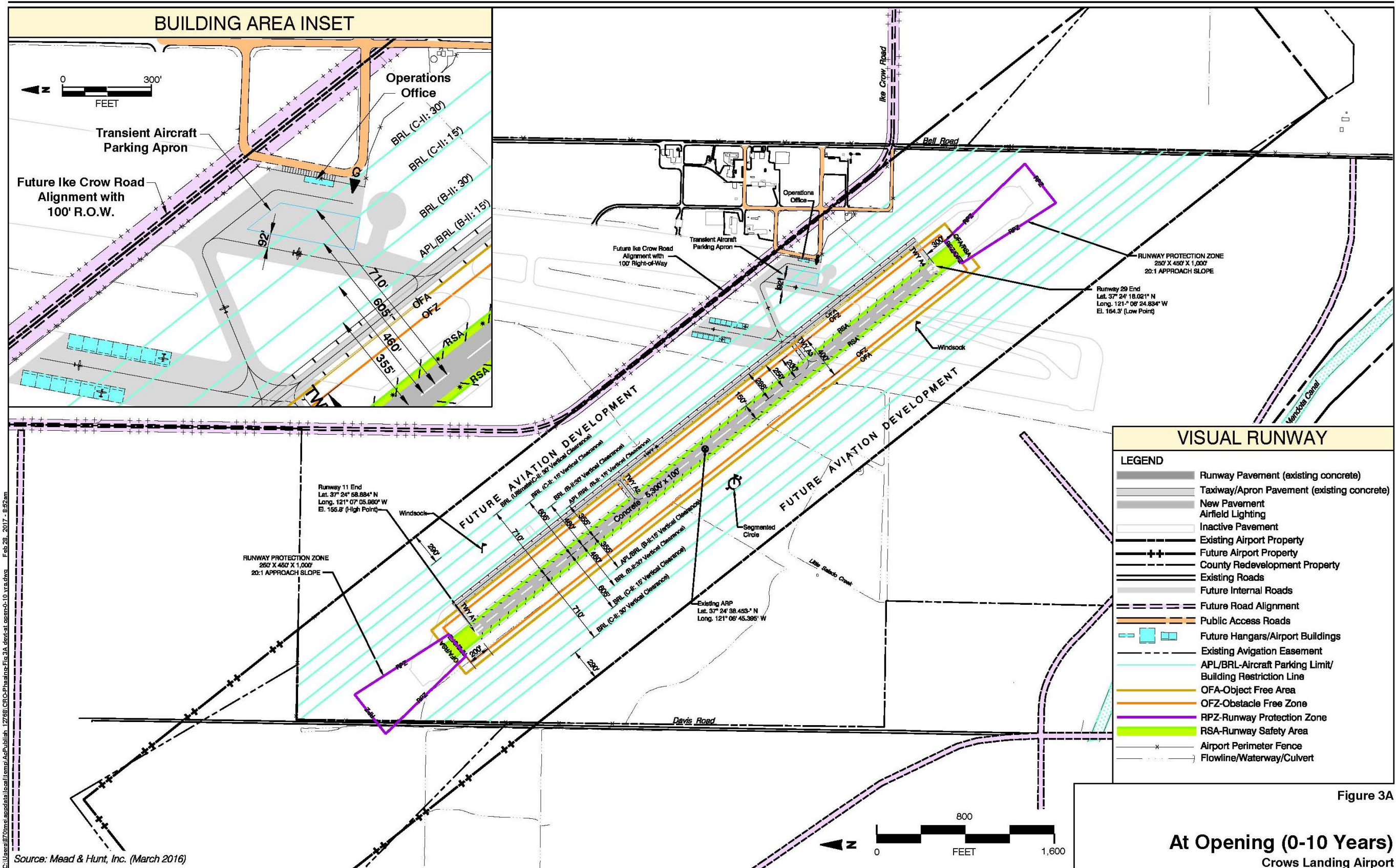
<sup>5</sup> Building restriction line (BRL) separation from Runway Centerline:

ARC B-II:15' = 355'; ARC B-II:30' = 460'; ARC C-II:15' = 605'; ARC C-II:30' = 710'

<sup>6</sup> APL separation requirement from taxiway centerline

Note: proposed design consistent with FAA airport design standards (FAA Advisory Circular 150/5300-13, Change 1, *Airport Design*).





C:\Users\jrd\OneDrive\Documents\Local\Mapa\Mapa\Pub\Pub\12758\_CFD\_CFD\Plan\Plan\Fig 3A.dwg 12/28/2017 8:52am  
 Source: Mead & Hunt, Inc. (March 2016)

Figure 3A

**At Opening (0-10 Years)**  
 Crows Landing Airport

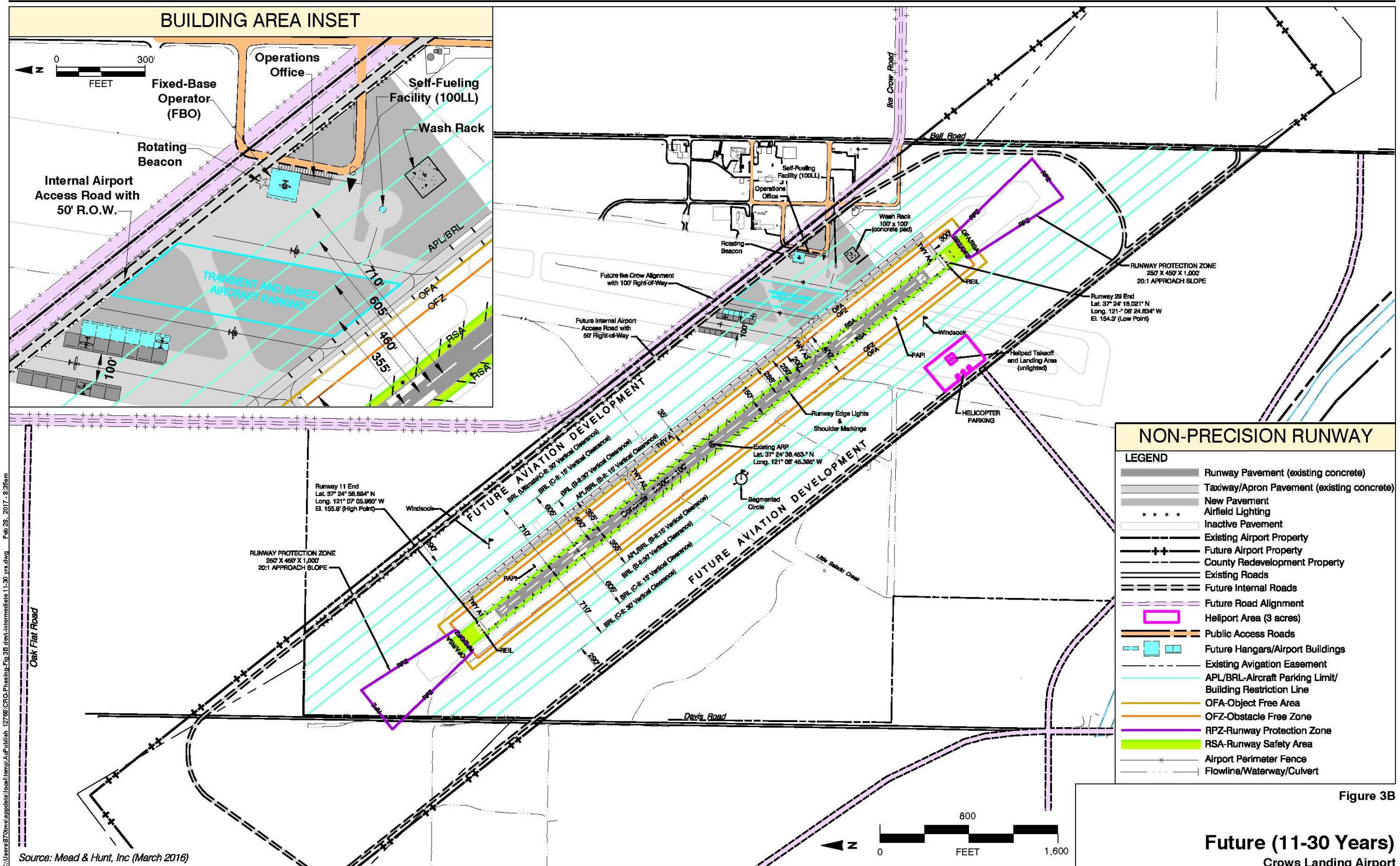


Figure 3B

Future (11-30 Years)  
Crows Landing Airport

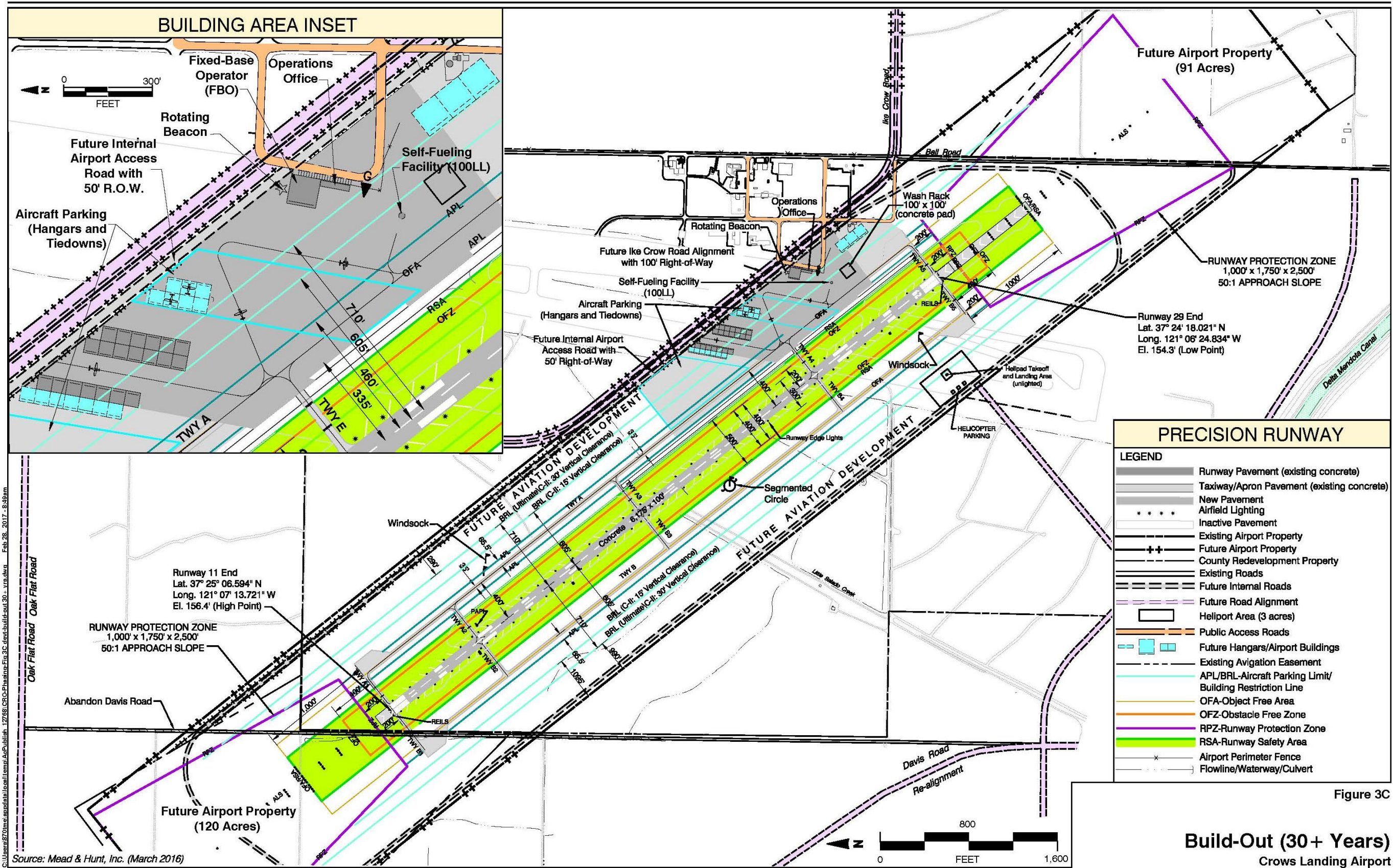


Figure 3C

**Build-Out (30+ Years)**  
 Crows Landing Airport

C:\Users\870me\AppData\Local\Temp\AsP\Pub\127688\_CRCO-Phase-1-Fig-3C.dwg; build-out 30+ yrs.dwg; Feb 28, 2017 - 8:49am  
 Source: Mead & Hunt, Inc. (March 2016)



**CHAPTER 4**  
**AIRPORT PLANS**

---



# 4

## AIRPORT PLANS

An Airport Layout Plan (ALP) is a graphic representation of the airport owner's intentions regarding the future course of airport development. The ALP is a key document that serves as a reference to aviation requirements, as well as to land use and financial planning. It is a prerequisite for state or federal funding of airport improvement projects. The California Division of Aeronautics requires approval of an ALP in order for the airport to qualify for issuance of an operating permit and possible California Aid to Airports Program funding. At the federal level, a current airport layout plan must be approved by the Federal Aviation Administration (FAA) before a project can become eligible for funding under the Airport Improvement Program (AIP). In addition, proposed capital projects must be consistent with the ALP, and the ALP must be updated periodically.

This chapter describes the plan documents associated with the recommended airport development program as set forth in Chapter 3. Airfield and building area improvements are necessary to maintain safety and operational efficiency and to accommodate projected aviation demand.

It is anticipated that the Crows Landing Airport will seek classification as a National Plan of Integrated Airport Systems (NPIAS) airport. The NPIAS identifies existing and proposed airports that are significant to national air transportation and thus eligible to receive Federal grants under the AIP. The NPIAS also includes estimates of the amount of AIP money needed to fund infrastructure development projects that will bring these airports up to current design standards and add capacity to congested airports. A majority of the NPIAS projects are considered to be of high-priority as they are intended to rehabilitate existing infrastructure and enhance airport safety. The timing of these improvements may be affected by economic conditions.

### AIRPORT LAYOUT PLAN DRAWINGS

As presented at the end of this report, the Crows Landing Airport ALP set consists of the following drawings: Index Sheet (Sheet 1), ALP (Sheet 2), Airport Data (Sheet 3), Airspace Plan (Sheets 4 to 5), and Property Map (Sheet 6). Although the Airport is These drawings are prepared guidelines set forth in Title 21, Section 3534 of the California Code of Regulations and FAA criteria established in FAA's Advisory Circular 150/5300-13, *Change 1, Airport Design*, FAA Advisory Circular 150/5070-6A, *FAA Standard Operating Procedures 2.00 and 3.00*, and Title 14 of the Code of Federal Regulations (CFR) Part 77, *Safe, Efficient Use, and Preservation of Navigable Airspace*. The principal drawing illustrating the long-term development plan for the Airport is the Airport Layout Plan itself (Sheet 2). The Part 77 Airspace Plan defines the airspace required for air navigation.

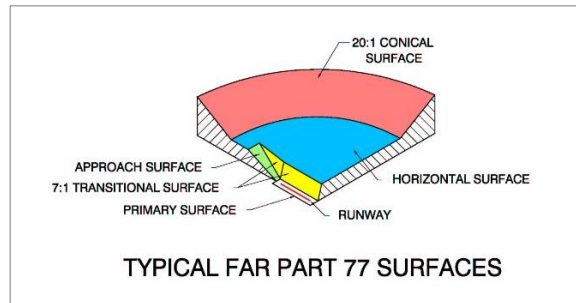
## Airport Layout Plan

The ALP drawing (Sheet 2) depicts the phased development of the Crows Landing Airport, including the recommended locations of the runway, apron area, and other supporting airport facilities (e.g., internal access road, heliport). Pertinent clearance and dimensional information are indicated as needed to show conformance with applicable airport standards. Other important data, (airport latitude, longitude, and elevation; runway gradient and orientation; pavement strength; expected number of based aircraft; etc.) are noted in tabular form.

## Airspace Plan

The principal strategy of mitigating hazards within the vicinity of an airport centers on FAA regulations set forth in 14 CFR Part 77, *Safe, Efficient Use, and Preservation of Navigable Airspace*. Part 77 establishes regulatory standards for determining obstructions to navigable airspace and the effects of such obstructions on the safe and efficient use of that airspace. The regulations

require that the FAA be notified of proposed construction or alteration of objects—whether permanent, temporary, or of natural growth—if those objects would achieve a height which exceeds the FAR Part 77 criteria. The height limits are defined in terms of imaginary surfaces in the airspace and extend approximately 2 to 3 miles around airport runways and approximately 9.5 miles from the



ends of runways having a precision instrument approach. The FAA conducts an aeronautical study of proposed construction and determines whether the use would be a hazard to air navigation. The evaluation considers only the height of the proposed structure(s). The FAA may recommend removal, marking, or lighting the obstruction(s). The Airspace Plan consists of Sheets 3 and 4.

The FAA also provides guidance on avoiding certain land uses on or near an airport which could endanger or interfere with the landing, taking off, or maneuvering of an aircraft at an airport. Specific land use characteristics to be avoided include:

- Tall structures
- Hazardous wildlife attractants
- Creation of glare, dust, steam, or smoke, which could impair visibility for pilots
- Lights that could be mistaken for airport lights or otherwise interfere with a pilot's vision
- Facilities that produce electronic interference with aircraft communications or navigation equipment

## FINANCIAL FACTORS

One of the means available to help ensure financially sound airport development is to avoid facility construction too far in advance of the demand. As noted in Chapter 2, the growth in numbers of based and transient aircraft at Crows Landing Airport is expected to be moderate throughout the 30-year planning horizon. The growth rate for the principal measure of demand—the size of the airport's based aircraft fleet—is expected to average two percent per year. However, it is more



likely that increases in the fleet size will occur in erratic increments rather than in the consistent two to three percent annual rate of growth rate suggested.

## Development Staging

The challenges to the appropriate staging of airport facility development over an extended period of time are twofold.

- One challenge is to minimize costly “Phase 1” construction that may not be fully utilized (and paid for) for many years.
- Another challenge is posed by the need to ensure that early development is not located in a manner that, while perhaps less expensive initially, hinders future development.

The overall goal of an ALP is to establish a plan that is flexible enough to adapt to changes in type and pace of facility demands, is cost-effective, and optimizes functionality during each stage of development.

## Financial Issues

Because the opening of a new airport is a complex project, special attention needs to be given to certain financial issues. (Advance recognition of potential problems will help to avoid costly remedies later.) Not only is it important to take all the necessary actions, but it is also important to take these actions in the proper sequence. Among these issues are:

- **Funding Commitments** – Unless another source of funding is readily available, County expenditure of any significant sums of money for engineering design or other work should await notice of a tentative allocation of funds from the FAA following inclusion in the NPIAS.
- **Role of Project Engineer** – Regardless of whether County staff is utilized or a consultant is hired, the project engineer should be familiar with the entire airport development process.
- **Pre-application for Federal Grants** – The pre-application for Federal funds should state the estimated cost of the complete first stage of airport development including construction. The pre-application should be revised as engineering designs allow more refined estimates of development costs.

## Management and Operational Issues

Other issues that should be addressed prior to opening of a new airport include, but are not limited to:

- **Management Alternatives** – The form of management desired for the new airport must be determined and necessary personnel hired to perform on-site duties. For the Crows Landing Airport, it is recommended that the management be shared between County departments based on expertise.
- **Lease and Rental Agreements** – Consideration should be given to obtaining a fixed-base operator (FBO) for the airport. Also, rates and charges for T-hangars, tie-downs, and other facilities must be set.
- **Airport Rules and Regulations** – These should be adopted, even if only on an interim basis, before the new airport opens.

- **Airport Minimum Standards** – A set of standards that define the service, personnel, and facility requirements needed to conduct commercial operations on the airport should be established and in place prior to or shortly after place prior to the opening of the airport.
- **Land Use Controls** – Several actions, including the adoption of an Airport Land Use Compatibility Plan (ALUCP) by the County’s Airport Land Use Commission and the adoption of General Plan and Zoning Code amendments, are essential to the long-term viability of the new airport.

The following pre-planning, design, and operational tasks will need to be completed prior to opening the Crows Landing Airport for public use.

Table 4-1. Pre-Opening Issues Crows Landing Airport, Stanislaus County, California	
<b>Tasks</b>	<ul style="list-style-type: none"> <li>▪ Delineate an appropriate Airport access road system</li> <li>▪ Construct appropriate security fencing and gates to preclude inadvertent access to the Airport</li> <li>▪ Remove old military airfield surface markings and signs conflicting with new public-use general aviation airport requirements</li> <li>▪ Remove all former military obstructions/surface deviations/equipment/etc. that interfere with public-airport use</li> <li>▪ Mark former Runway 16-34 as permanently closed (i.e., with painted “X”s)</li> <li>▪ Clean and fill all cracks on Runway 11-29 (@ 5,300’ x 100’), parallel taxiway system (@ 35’ wide), and apron use areas</li> <li>▪ Restripe/remark/resign airfield surfaces (e.g., runway, taxiways, apron areas) as appropriate</li> <li>▪ Install segmented circle and three unlighted wind cones (one at each approach end and one at segmented circle)</li> <li>▪ Install tie-down anchors (cable-based or fixed point) as appropriate on aircraft parking aprons</li> <li>▪ Establish an operational focal-point (e.g., operations office, telephone, restrooms, etc.)</li> <li>▪ Endeavor to provide 24-hour user accessibility to telephone and restrooms</li> <li>▪ Provide a basic level of emergency response capability (e.g., locate portable fire extinguishers near apron areas, establish notification procedures for emergency response by local fire department, provide public telephone capability)</li> <li>▪ Determine the appropriate level of County staffing presence desired for Airport operational/maintenance/security/safety</li> <li>▪ Arrange for appropriate airport insurance coverage to protect the County</li> <li>▪ Apply for Airport Permit from California Division of Aeronautics</li> <li>▪ Issue appropriate Notices-To-Airmen announcing Airport availability</li> <li>▪ Facilitate development of privately-funded aircraft storage hangars as appropriate</li> </ul>

### Funding Sources

The primary source of funding for most of the substantial capital improvements recommended for Crows Landing Airport is the FAA following inclusion in the NPIAS. Limited funding is available through the Aeronautics Account of the California State Transportation Fund. Specific funding programs for airport improvement projects include the following:

### Federal Airport Improvement Program (AIP) Grants

AIP provides both entitlement funds and discretionary funds. These entitlement funds can be used each year that they become available or they can be held up to two years for a larger project. The AIP program also allows for discretionary funding to be made available from the FAA to provide financial support for capacity and safety-related projects, as well as projects intended to keep the critical components of the airfield operational (e.g., runway/taxiway rehabilitation).

Projects that are eligible for FAA AIP funding are determined based on guidelines contained in FAA Order 5100.38, *Airport Improvement Handbook*. As a general rule, only airport projects that are related to non-revenue producing facilities, such as airfield construction, public areas of a terminal, and land acquisition, have been eligible for federal funding. For general aviation airports in California, the FAA share is 95%, with a 5% match required from the airport sponsor.

## State of California Aviation Program

The State of California operates an airport grant program similar in concept to the Federal AIP program. The state grant program is administered by the California Department of Transportation's Division of Aeronautics. All grants are awarded on a competitive basis. Grants are judged using a numerical weighting scheme. As with the Federal program, priority is given to projects that enhance safety.

- **State Annual Grant**—General aviation airports are eligible to receive a \$10,000 annual grant. These funds can be used for airfield maintenance and construction projects, as well as airfield and land use compatibility planning. Airports can accumulate these funds for up to five years. No local match is required for an annual grant.
- **AIP Matching Grants**—This state grant assists the airport sponsor in meeting the local match for AIP grants from the FAA. The state's AIP matching grant provides 5% of the federal share of eligible projects. Currently, with the federal share at 95%, the state will contribute 4.75%, leaving the airport sponsor's match at just 0.25% of the project amount.
- **Acquisition and Development Grants**—This state grant program is similar to the FAA's AIP in that an outright grant is offered for qualifying projects. The local match can vary from 10% to 50% of the project's cost. The local match rate has been 10% during the last 25 years.

The Division of Aeronautics also administers a revolving loan program called the State Loan Program. Loans are available to provide funds to match AIP grants to develop revenue –producing facilities (e.g., aircraft storage hangars and fuel facilities). The interest rate is favorable and the payback period is between 8 and 17 years.

## Other Grant Programs

Airport projects can also sometimes qualify for grant funding from non-aviation sources. Although not commonly available, airports have received grants from a variety of federal and state programs including: economic development, community development, and rural infrastructure. Airports are encouraged to seek out and qualify for these non-aviation funding programs where applicable.

## Local/Airport Funds

At general aviation airports similar to the proposed Crows Landing Airport, airport sponsor self-funding is principally provided by a combination of airport-generated income and owner (County) funds. Funding airport improvements that are not grant eligible and providing the local matching share for grants-in-aid are usually the simplest most economical methods because direct interest costs are eliminated.

## Cost Estimates

The proposed 20+ year capital improvement program for Crows Landing Airport is presented in **Table 4-2**. Proposed improvements described in the preceding chapter are included on the list according to the proposed development phases discussed in Chapter 3.

- At Opening (0 to 10 years)
- Future (11 to 30 years)
- Ultimate Runway Buildout (>30 years)

The indicated costs are order-of-magnitude estimates in 2016 dollar values. Design engineering, construction inspection, and other related costs are included for each item and a contingency factor is added as well. The cost estimates are intended only for preliminary planning and programming purposes. Specific project analyses and detailed engineering design will be required at the time of project implementation to provide more refined and up-to-date estimates of the individual project costs.

The ALP drawing depicts the location of each of the proposed major improvements and the anticipated time frame of construction. The timing indicated is based upon the forecasts presented in Chapter 2. It is important to emphasize, though, that the general sequence of development indicated in the capital improvement program is more significant than the precise timing. The actual timing of major improvements will be driven by demand and funding availability, not by the calendar. If the growth rate of projected aviation activity is not realized, then each phase of development would extend over additional years. On the other hand, demand for construction of certain facilities could arise more quickly than the staging plan anticipates.

## NOISE IMPACTS

Approval for individual components of the airport capital improvement program recommended for Crows Landing Airport will occur within the environmental review framework of Stanislaus County. The environmental impacts associated with the Airport are being established as part of the General Plan Update for the Crows Landing Redevelopment Area and its immediate vicinity.

Noise is often described as unwanted or disruptive sound. A pure sound is measured in terms of: its magnitude, (often thought of as loudness) as indicated on the decibel (dB) scale; its frequency, (or tonal quality) measured in cycles per second (hertz); and its duration or length of time over which it occurs (See **Table 4-3** for examples of typical decibel levels). To measure the noise value of a sound other factors must also be considered. Airport noise is particularly complex to measure because of the widely varying characteristics of the individual sound events and the intermittent nature of these events' occurrence.

### CNEL Contour Calculations Inputs

- *The number of operations by aircraft type or group.*
- *The distribution of operations by time of day for each aircraft type.*
- *The average takeoff profile and standard approach slope used by each aircraft type.*
- *The amount of noise transmitted by each aircraft type, measured at various distances from the aircraft.*
- *The runway system configuration and runway lengths.*
- *Runway utilization distribution by aircraft type and time of day.*
- *The geometry of common aircraft flight tracks.*
- *The distribution of operations for each flight track.*

---

In an attempt to provide a single measure of airport noise impacts, various cumulative noise level

metric have been devised. The metric most commonly used in California is the Community Noise Equivalent Level (CNEL). The results of CNEL calculations are normally depicted by a series of contours representing points of equal noise exposure in 5 dB increments. Key factors involved in calculation CNEL contours are noted to the left.

Noise contours were prepared using the FAA's Integrated Noise Model (Version 7.0). The results are presented at the end of this chapter. **Figure 4B** presents the aircraft noise contours for the activity levels at opening. Future (11 – 30 years) aircraft noise contours are presented in **Figure 4C**. **Table 4-4** summarizes airport activity data.

**Crows Landing Airport**

Capital Improvement Plan Cost Estimates - DRAFT

Phased Projects		Cost Estimate
<b>Short Term: At Opening to 10 Years</b>		
A1	Remove old runway lighting and level runway RSA, OFZ and OFA	\$ 712,000
A2	Perform Airport Pavement Management Plan and clean and fill runway/taxiway/apron pavement cracks / other pavement repairs	\$ 589,600
A3	Prepare Airfield Marking Plan, remove old airfield marking and paint new taxiway and runway markings for visual runway	\$ 214,000
A4	Repair airport access roads and utilities	\$ 425,000
A5	Construct airport entrance and parking spaces	\$ 468,000
A6	Install airport entrance sign	\$ 60,000
A7	Install apron security lighting near airport entrance	\$ 210,000
A8	Install 25,000 LF 8 foot fence with 3-strand barbed wire along airport boundary and manual gate at airport entrance	\$ 890,000
A9	Install 4 taxiway hold signs	\$ 30,000
A10	Install segmented circle and 3 wind cones (non-lit)	\$ 72,500
A11	Install 10 tiedowns and site preparation for 5 hangars	\$ 122,500
A12	Install 780 s.f. modular unit for operations office with restrooms and utility connections	\$ 256,750
A13	Install 12,000 gallon skid-mounted general aviation fuel tank (100LL), jet-A refueler truck, truck pad and wash rack	\$ 160,000
A14	Construct Connector Taxiways A2, A3, A4, A5.	\$ 400,000
		<b>Subtotal</b>
		<b>\$ 4,610,350</b>
<b>Intermediate Term: 11 to 30 Years</b>		
B1	Construct additional apron area to accommodate aircraft tiedowns, hangars and FBO sites	\$ 4,110,000
B2	Construct internal perimeter access road and install manual gate at Bell Road to access helipad	\$ 505,000
B3	Paint helipad markings on southwest side of runway	\$ 25,000
B4	Remark Runway 11-29 to reflect non-precision (GPS based) instrument approach	\$ 60,000
B5	Install Medium Intensity Runway Edge Lights (MIRL)	\$ 398,300
B6	Install Runway End Identifier Lights (REILS) at each runway end	\$ 42,550
B7	Install Precision Approach Path Indicator (PAPI) at each runway end	\$ 334,500
B8	Install rotating beacon	\$ 40,000
B9	Light existing wind cones (3 wind cones)	\$ 43,500
B10	Construct additional apron area northeast of airfield	\$ 4,860,000
B11	Replace modular unit with permanent terminal building including pilot lounge, restrooms and airport office space(s)	\$ 450,000
		<b>Subtotal</b>
		<b>\$ 10,868,850</b>
<b>Runway Build Out Concept: 30+ Years</b>		
D1	Acquire 202 acres for future airport expansion and remove obstructions	TBD
D2	Construct 1,000-foot extension of Runway 11 to north & blast pad, realign REILS, & remark runway for precision instrument approach	TBD
D3	Construct and mark new parallel taxiway and remark old taxiway pavement as closed	TBD
D4	Construct internal perimeter access road around Runway 11 extension, abandon segment of Davis Road and remove segment of perimeter fence	TBD
D5	Install 10,500 ft. of perimeter security fencing to enclose future airport property and additional security gate	TBD
D6	Install MALSR approach lighting at both ends of Runway 11-29	TBD
D7	Mark blast pad for Runway 29	TBD
D8	Construct additional apron area west of runway	TBD
		<b>Subtotal</b>
		<b>TBD</b>
		<b>TOTAL</b>
		<b>\$ 15,479,200</b>
* Aircraft storage hangars anticipated to be provided by private sector		
** Cost estimates in 2016 dollars		

**Table 4-2. Airport Improvement Cost Estimates**

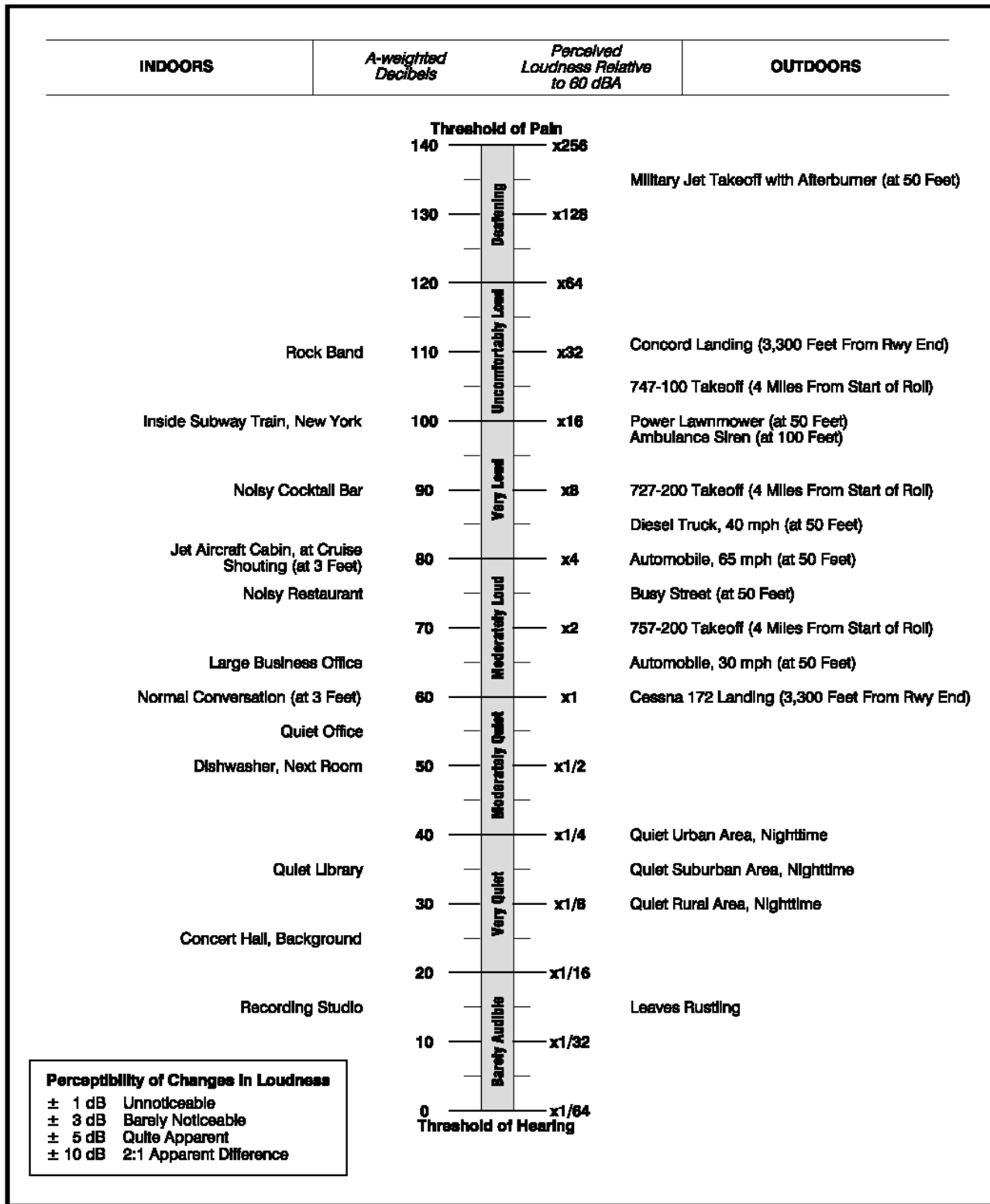


Table 4-3

<b>BASED AIRCRAFT</b>			<b>RUNWAY USE DISTRIBUTION <sup>A</sup></b>		
	<b>At Opening <sup>a</sup></b>	<b>Future <sup>b</sup></b>		<b>At Opening</b>	<b>Future</b>
	<i>Year 0-10</i>	<i>11-30 Years</i>		<i>Year 0-10</i>	<i>11-30 Years</i>
<i>Aircraft Type</i>			<i>All Aircraft</i>		
Single-Engine, Piston	10	50	Runway 11	20%	20%
Twin-Engine, Piston	--	10	Runway 29	80%	80%
Turboprop	--	14			
Business Jets	--	6			
<i>Total</i>	<i>10</i>	<i>80</i>			
<hr/>			<i>Distribution by Operation and Aircraft Type</i>		
<i>Aircraft Operations</i>			<i>Takeoffs / Landings - Day/Evening/Night</i>		
	<b>At Opening <sup>a</sup></b>	<b>Future <sup>b</sup></b>	<i>Single-Engine, Piston</i>		
	<i>Year 0-10</i>	<i>11-30 Years</i>	<i>Runway 11</i>		
<i>Total</i>			<i>Runway 29</i>		
Annual	4,000	34,000		20%	20%
Average Day	11	93		80%	80%
<i>Distribution by Aircraft Type</i>			<i>Twin-Engine, Piston</i>		
Single-Engine, Piston	100%	65%	Runway 11	20%	20%
Twin-Engine Piston	--	10%	Runway 29	80%	80%
Turboprop	--	15%			
Business Jet	--	10%	<i>Turboprop</i>		
<i>Distribution by Type of Operation</i>			<i>Runway 11</i>		
Local	75%	44%	<i>Runway 29</i>		
(incl. touch-and-goes)				20%	20%
Itinerant	25%	56%		80%	80%
<hr/>			<i>Business Jets</i>		
<i>Time of Day Distribution <sup>A</sup></i>			<i>Runway 11</i>		
	<b>At Opening</b>	<b>Future <sup>b</sup></b>	<i>Runway 29</i>		
	<i>Year 0-10</i>	<i>11-30 Years</i>	<i>Touch-and-go operations - Day/Evening/Night</i>		
<i>All Aircraft</i>			<i>Single-Engine, Piston</i>		
Day (7am to 7pm)	98%	85%	<i>Runway 11</i>		
Evening (7pm to 10pm)	2%	10%	<i>Runway 29</i>		
Night (10pm to 7am)	--	5%		20%	20%
				80%	80%
			<hr/>		
			<i>Flight Track Use <sup>A</sup></i>		
			> 100% straight-out departures		
			> 100% straight-in arrivals		
			> Tough-and-go: 100% left traffic		
<hr/>					
<b>Notes</b>					
<sup>a</sup> Estimated by Mead & Hunt and ESA Airports for compatibility planning purposes.					
<sup>b</sup> Estimate represents the theoretical capacity as established for the Draft Airport Layout Plan Narrative Report. This forecast scenario assumes full build-out of the adjacent Crows Landing Industrial Business Park. The timeframe is undefined but assumed to be beyond 2046.					

Typical Decibel Level of Common Sounds

**Table 4-4**  
**Airport Activity Data Summary**  
**Crows Landing Airport**



**LEGEND**

- Stanislaus County Redevelopment Property
- Existing Crows Landing Airport Property
- Future Crows Landing Airport Property
- At Opening (0-10 Years)
- Future (11-30 Years)
- Ultimate Build-out (30+ Years)

(Refer to Table 4-1 for project descriptions and cost estimates)



Source: Mead & Hunt, Inc. (March 2016)

Figure 4A  
**Airport Improvement Staging Plan**  
Crows Landing Airport

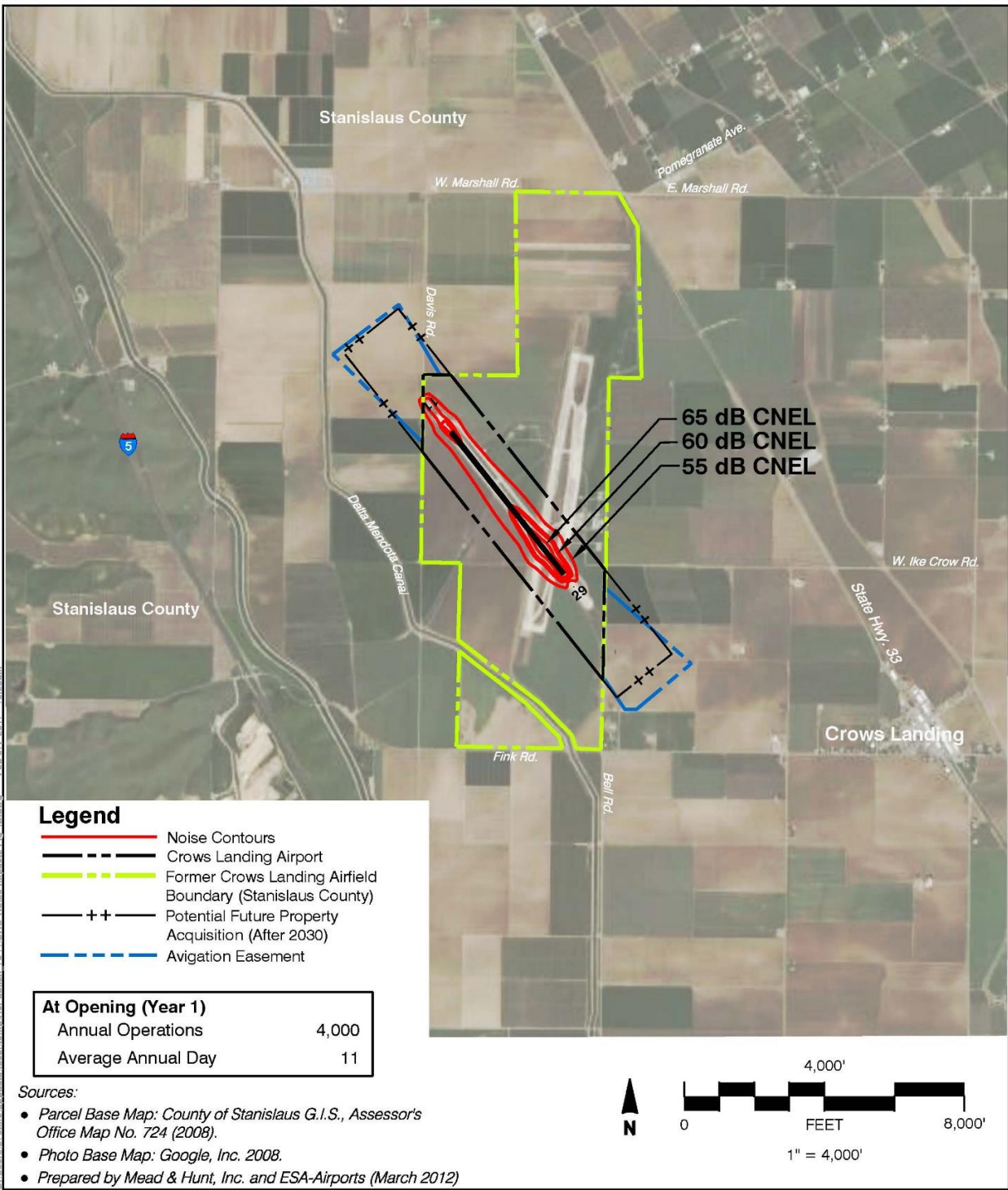


Figure 4B

**Noise Impacts — At Opening (Year 1)**  
Crows Landing Airport

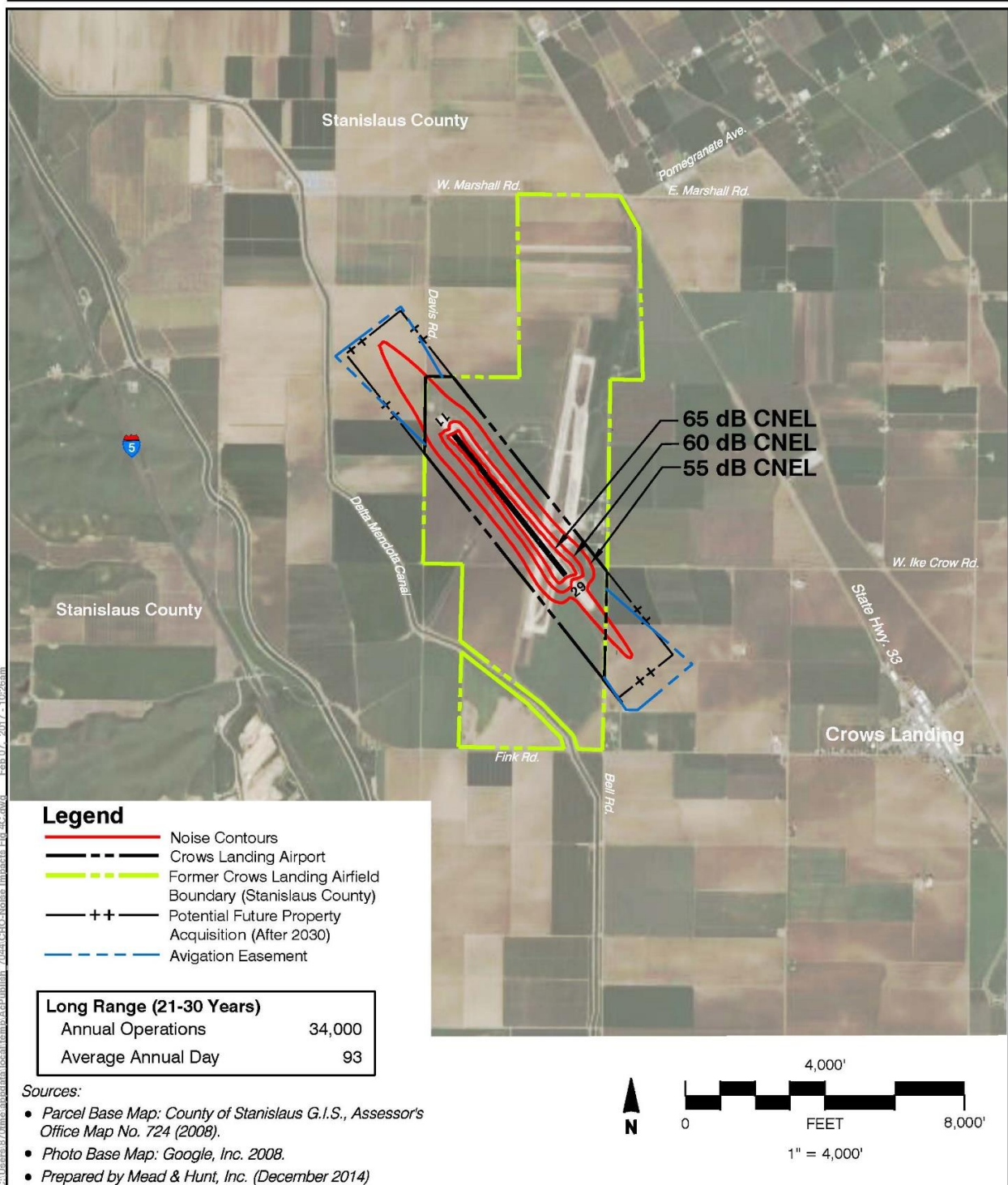


Figure 4C

## Noise Impacts — Long Range (11-30 Years) Crows Landing Airport



**APPENDIX A**

---

**GLOSSARY OF TERMS**



Crows Landing Airport Plan Narrative Report  
February 2017



## Glossary of Terms

**ABOVE GROUND LEVEL (AGL):** An elevation datum given in feet above ground level.

**AIR CARRIER:** A person who undertakes directly by lease, or other arrangement, to engage in air transportation. (FAR 1) (Also see Certificated Air Carrier)

**AIR CARRIERS:** The commercial system of air transportation, consisting of the certificated air carriers, air taxis (including commuters), supplemental air carriers, commercial operators of large aircraft, and air travel clubs. (FAA Census)

**AIR ROUTE TRAFFIC CONTROL CENTER (ARTCC):** A facility established to provide air traffic control service to aircraft operating on IFR flight plans within controlled airspace, principally during the en route phase of flight. When equipment capabilities and controller workload permit, certain advisory/assistance services may be provided to VFR aircraft. (AIM)

**AIR TAXI:** A classification of air carriers which directly engage in the air transportation of persons, property, mail, or in any combination of such transportation and which do not directly or indirectly utilize large aircraft (over 30 seats or a maximum payload capacity of more than 7,500 pounds) and do not hold a Certificate of Public Convenience and Necessity or economic authority issued by the Department of Transportation. (Also see commuter air carrier and demand air taxi.) (FAA Census)

**AIR TRAFFIC CONTROL (ATC):** A service operated by appropriate authority to promote the safe, orderly, and expeditious flow of air traffic. (FAR 1)

**AIRCRAFT ACCIDENT:** An occurrence associated with the operation of an aircraft which takes place between the time any person boards the aircraft with the intention of flight and all such persons have disembarked, and in which any person suffers death or serious injury, or in which the aircraft receives substantial damage. (NTSB)

**AIRCRAFT APPROACH CATEGORY:** A grouping of aircraft (Categories A–E) based on 1.3 times their stall speed in their landing configuration at their maximum certificated landing weight. (Airport Design)

**AIRCRAFT OPERATION:** The airborne movement of aircraft in controlled or non-controlled airport terminal areas and about given en route fixes or at other points where counts can be made. There are two types of operations — local and itinerant. (FAA Stats)

**AIRCRAFT PARKING LINE LIMIT (APL):** A line established by the airport authorities beyond which no part of a parked aircraft should protrude. (Airport Design)

**AIR/FIRE ATTACK BASE:** An established on-airport base of operations for the purposes of aerial suppression of large-scale fires by specially-modified aircraft. Typically, such aircraft are operated by the California Department of Forestry and/or the U.S. Forest Service.

**AIRPLANE DESIGN GROUP:** A grouping of airplanes (Groups I–V) based on wingspan. (Airport Design)

**AIRPORT:** An area of land or water that is used or intended to be used for the landing and takeoff of aircraft, and includes its buildings and facilities, if any. (FAR 1)

**AIRPORT ELEVATION:** The highest point of an airport's usable runways, measured in feet above mean sea level. (AIM)

---

**AIRPORT HAZARD:** Any structure or natural object located on or in the vicinity of a public airport, or any use of land near such airport, that obstructs the airspace required for the flight of aircraft in landing or taking off at the airport or is otherwise hazardous to aircraft landing, taking off, or taxiing at the airport. (Airport Design)

**AIRPORT LAND USE COMMISSION (ALUC):** A commission established in accordance with the California State Aeronautics Act in each county having an airport operated for the benefit of the general public. The purpose of each ALUC is -to assist local agencies in ensuring compatibility land uses in the vicinity of all new airports and in the vicinity of existing airports to the extent that the land in the vicinity of those airports is not already devoted to incompatible uses. An ALUC need not be created if an alternative process, as specified by the statutes, is established to accomplish the same purpose. (California Public Utilities Code, Section 21670 et seq.)

**AIRPORT LAYOUT PLAN (ALP):** A scale drawing of existing and proposed airport facilities, their location on the airport, and the pertinent clearance and dimensional information required to demonstrate conformance with applicable standards.

**AIRPORT REFERENCE CODE (ARC):** A coding system used to relate airport design criteria to the operational and physical characteristics of the airplanes intended to operate at the airport. (Airport Design)

**AIRPORT REFERENCE POINT (ARP):** A point established on an airport, having equal relationship to all existing and proposed landing and takeoff areas, and used to geographically locate the airport and for other planning purposes. (Airport Design)

**AIRPORT TRAFFIC CONTROL TOWER (ATCT):** A terminal facility that uses air/ground communications, visual signaling, and other devices to provide ATC services to aircraft operating in the vicinity of an airport or on the movement area. (AIM)

**AIRWAY/FEDERAL AIRWAY:** A Class E airspace area established in the form of a corridor, the centerline of which is defined by radio navigational aids. (AIM)

**ALERT AREA:** A special use airspace which may contain a high volume of pilot training activities or an unusual type of aerial activity, neither of which is hazardous to aircraft. (AIM)

**APPROACH LIGHT SYSTEM (ALS):** An airport lighting system which provides visual guidance to landing aircraft by radiating light beams in a directional pattern by which the pilot aligns the aircraft with the extended runway centerline during a final approach to landing. Among the specific types of systems are:

- **LDIN**—Lead-in Light System.
- **MALSR**—Medium-intensity Approach Light System with Runway Alignment Indicator Lights.
- **ODALS**—Omnidirectional Approach Light System, a combination of LDIN and REILS.
- **SSALR**—Simplified Short Approach Light System with Runway Alignment Indicator Lights. (AIM)

**APPROACH SPEED:** The recommended speed contained in aircraft manuals used by pilots when making an approach to landing. This speed will vary for different segments of an approach as well as for aircraft weight and configuration. (AIM)

**AUTOMATED WEATHER OBSERVING SYSTEM (AWOS):** Airport electronic equipment which automatically measures meteorological parameters, reduces and analyzes the data via computer, and broadcasts weather information which can be received on aircraft radios in some applications, via telephone.

**AUTOMATIC DIRECTION FINDER (ADF):** An aircraft radio navigation system which senses and indicates the direction to a L/MF nondirectional radio beacon (NDB) ground transmitter. (AIM)



---

**AUTOMATIC TERMINAL INFORMATION SERVICE (ATIS):** The continuous broadcast of recorded non-control information in selected terminal areas. (AIM)

**BACK COURSE APPROACH:** A non-precision instrument approach utilizing the rearward projection of the ILS localizer beam.

**BALANCED FIELD LENGTH:** The runway length at which the distance required for a given aircraft to abort a takeoff and stop on the runway (accelerate-stop distance) equals the distance required to continue the takeoff and reach a height of 35 feet above the runway end (accelerate-go distance).

**BASED AIRCRAFT:** Aircraft stationed at an airport on a long-term basis.

**BUILDING RESTRICTION LINE (BRL):** A line which identifies suitable building area locations on airports.

**CEILING:** Height above the earth's surface to the lowest layer of clouds or obscuring phenomena that is reported as "broken", "overcast", or "obscuration" and is not classified as "thin" or "partial". (AIM)

**CERTIFICATED ROUTE AIR CARRIER:** An air carrier holding a Certificate of Public Convenience and Necessity issued by the Department of Transportation authorizing the performance of scheduled service over specified routes, and a limited amount of nonscheduled service. (FAA Census)

**CIRCLING APPROACH/CIRCLE-TO-LAND MANEUVER:** A maneuver initiated by the pilot to align the aircraft with a runway for landing when a straight-in landing from an instrument approach is not possible or is not desirable. (AIM)

**COMMERCIAL OPERATOR:** A person who, for compensation or hire, engages in the carriage by aircraft in air commerce of persons or property, other than as an air carrier. (FAR 1)

**COMPASS LOCATOR:** A low power, low or medium frequency (L/MF) radio beacon installed at the site of the outer or middle marker of an instrument landing system (ILS). (AIM)

**COMPASS ROSE:** A circle, graduated in degrees, printed on some charts or marked on the ground at an airport. It is used as a reference to either true or magnetic direction. (AIM)

**COMMUNITY NOISE EQUIVALENT LEVEL (CNEL):** The noise rating adopted by the State of California for measurement of airport noise. It represents the average daytime noise level during a 24-hour day, measured in decibels and adjusted to an equivalent level to account for the lower tolerance of people to noise during evening and nighttime periods.

**COMMUTER AIR CARRIER:** An air taxi operator which performs at least five round trips per week between two or more points and publishes flight schedules which specify the times, days of the week and places between which such flights are performed. (FAA Census)

**CONTROLLED AIRSPACE:** A generic term that covers the different classifications of airspace (Class A, Class B, Class C, Class D and Class E airspace) and defines dimensions within which air traffic control service is provided to IFR flights and to VFR flights in accordance with the airspace classification. Controlled airspace in the United States is designated as follows:

- **Class A**—Generally, that airspace from 18,000 feet MSL up to and including 60,000 feet MSL (Flight Level 600), including the airspace overlying the waters within 12 nautical miles of the coast of the 48 contiguous states and Alaska. Unless otherwise authorized, all persons must operate their aircraft under IFR.
- **Class B**—Generally, that airspace from the surface to 10,000 feet MSL surrounding the nation's busiest airports in terms of airport operations or passenger enplanements. The configuration of each Class B airspace area is individually tailored and consists of a surface area and two or more layers (some Class B airspaces areas resemble upside-down wedding cakes), and is designed to contain all published instrument procedures once an aircraft enters the airspace. An ATC

---

clearance is required for all aircraft to operate in the area, and all aircraft that are so cleared receive separation services within the airspace. The cloud clearance requirement for VFR operations is "clear of clouds".

- **Class C**—Generally, that airspace from the surface to 4,000 feet above the airport elevation (charted in MSL) surrounding those airports that have an operational control tower, are serviced by radar approach control, and that have a certain number of IFR operations or passenger enplanements. Although the configuration of each Class C airspace area is individually tailored, the airspace usually consists of a surface area with a 5 nm radius, and an outer area with a 10 nm radius that extends from 1,200 feet to 4,000 feet above the airport elevation. Each person must establish two-way radio communications with the ATC facility providing air traffic services prior to entering the airspace and thereafter maintain those communications while within the airspace. VFR aircraft are only separated from IFR aircraft within the airspace.
- **Class D**—Generally, that airspace from the surface to 2,500 feet above the airport elevation (charted in MSL) surrounding those airports that have an operational control tower. The configuration of each Class D airspace area is individually tailored and when instrument procedures are published, the airspace will normally be designed to contain the procedures. Arrival extensions for instrument approach procedures may be Class D or Class E airspace. Unless otherwise authorized, each person must establish two-way radio communications with the ATC facility providing air traffic services prior to entering the airspace and thereafter maintain those communications while in the airspace. No separation services are provided to VFR aircraft.
- **Class E**—Generally, if the airspace is not Class A, Class B, Class C, or Class D, and it is controlled airspace, it is Class E airspace. Class E airspace extends upward from either the surface or a designated altitude to the overlying or adjacent controlled airspace. When designated as a surface area, the airspace will be configured to contain all instrument procedures. Also in this class are Federal airways, airspace beginning at either 700 or 1,200 feet AGL used to transition to/from the terminal or en route environment, en route domestic, and offshore airspace areas designated below 18,000 feet MSL. Unless designated at a lower altitude, Class E airspace begins at 14,500 MSL over the United States, including that airspace overlying the waters within 12 nautical miles of the coast of the 48 contiguous States and Alaska. Class E airspace does not include the airspace 18,000 feet MSL or above.

**DEMAND AIR TAXI:** Use of an aircraft operating under Federal Aviation Regulations, Part 135, passenger and cargo operations, including charter and excluding commuter air carrier. (FAA Census)

**DISPLACED THRESHOLD:** A threshold that is located at a point on the runway other than the designated beginning of the runway. (AIM)

**DISTANCE MEASURING EQUIPMENT (DME):** Equipment (airborne and ground) used to measure, in nautical miles, the slant range distance of an aircraft from the DME navigational aid. (AIM)

**FAR PART 77:** The part of the Federal Aviation Regulations that deals with objects affecting navigable airspace.

**FAR PART 77 SURFACES:** Imaginary surfaces established with relation to each runway of an airport. There are five types of surfaces: (1) primary; (2) approach; (3) transitional; (4) horizontal; and (5) conical.

**FEDERAL AVIATION ADMINISTRATION (FAA):** The United States government agency that is responsible for insuring the safe and efficient use of the nation's airspace.

**FIXED BASE OPERATOR (FBO):** A business operating at an airport that provides aircraft services to the general public, including but not limited to sale of fuel and oil; aircraft sales, rental, maintenance, and repair; parking and tiedown or storage of aircraft; flight training; air taxi/charter operations; and specialty services, such as instrument and avionics maintenance, painting, overhaul, aerial application, aerial photography, aerial hoists, or pipeline patrol.

---

**FLIGHT SERVICE STATION (FSS):** FAA facilities which provide pilot briefings on weather, airports, altitudes, routes, and other flight planning information.

**FRACTIONAL OWNERSHIP:** A company or individual buys, or leases, a fractional interest in one aircraft just as they might acquire a partial interest in one condo unit. They can use their own aircraft or another similar or identical aircraft a certain number of hours or days per year. The economics of each situation differs depending on the number of people who will use the aircraft, the value of their time to the company, and the dollars saved in airline tickets, hotels, etc.

**GENERAL AVIATION:** That portion of civil aviation which encompasses all facets of aviation except air carriers. (FAA Stats)

**GENERIC VISUAL GLIDE SLOPE INDICATOR (GVGI):** A generic term for the group of airport visual landing aids which includes Visual Approach Slope Indicators (VASI), Precision Approach Path Indicators (PAPI), and Pulsed Light Approach Slope Indicators (PLASI). When FAA funding pays for this equipment, whichever type receives the lowest bid price will be installed unless the airport owner wishes to pay the difference for a more expensive unit.

**GLIDE SLOPE:** An electronic signal radiated by a component of an ILS to provide descent path guidance to approaching aircraft.

**GLOBAL POSITIONING SYSTEM (GPS):** A relatively new navigational system which utilizes a network of satellites to determine a positional fix almost anywhere on or above the earth. Developed and operated by the U.S. Department of Defense, GPS has been made available to the civilian sector for surface, marine, and aerial navigational use. For aviation purposes, the current form of GPS guidance provides en route aerial navigation and selected types of nonprecision instrument approaches. Eventual application of GPS as the principal system of navigational guidance throughout the world is anticipated.

**HELIPAD:** A small, designated area, usually with a prepared surface, on a heliport, airport, landing/takeoff area, apron/ramp, or movement area used for takeoff, landing, or parking of helicopters. (AIM)

**INSTRUMENT APPROACH PROCEDURE:** A series of predetermined maneuvers for the orderly transfer of an aircraft under instrument flight conditions from the beginning of the initial approach to a landing or to a point from which a landing may be made visually. It is prescribed and approved for a specific airport by competent authority. (AIM)

**INSTRUMENT FLIGHT RULES (IFR):** Rules governing the procedures for conducting instrument flight. Also term used by pilots and controllers to indicate a type of flight plan. (AIM)

**INSTRUMENT LANDING SYSTEM (ILS):** A precision instrument approach system which normally consists of the following electronic components and visual aids: (1) Localizer; (2) Glide Slope; (3) Outer Marker; (4) Middle Marker; (5) Approach Lights. (AIM)

**INSTRUMENT OPERATION:** An aircraft operation in accordance with an IFR flight plan or an operation where IFR separation between aircraft is provided by a terminal control facility. (FAA ATA)

**INSTRUMENT RUNWAY:** A runway equipped with electronic and visual navigation aids for which a precision or non-precision approach procedure having straight-in landing minimums has been approved. (AIM)

**ITINERANT OPERATION:** An arrival or departure performed by an aircraft from or to a point beyond the local airport area.

**LARGE AIRCRAFT:** An aircraft of more than 12,500 pounds maximum certificated takeoff weight. (FAR 1)

---

**LIMITED REMOTE COMMUNICATIONS OUTLET (LRCO):** An unmanned, remote air/ground communications facility which may be associated with a VOR. It is capable only of receiving communications and relies on a VOR or a remote transmitter for full capability.

**LOCALIZER (LOC):** The component of an ILS which provides course guidance to the runway. (AIM)

**LOCAL OPERATION:** An arrival or departure performed by an aircraft: (1) operating in the traffic pattern, (2) known to be departing or arriving from flight in local practice areas, or (3) executing practice instrument approaches at the airport. (FAA ATA)

**LORAN:** An electronic ground-based navigational system established primarily for marine use but used extensively for VFR and limited IFR air navigation.

**MARKER BEACON (MB):** The component of an ILS which informs pilots, both aurally and visually, that they are at a significant point on the approach course.

**MEAN SEA LEVEL (MSL):** An elevation datum given in feet from mean sea level.

**MEDIUM-INTENSITY APPROACH LIGHTING SYSTEM (MALS):** The MALS is a configuration of steady-burning lights arranged symmetrically about and along the extended runway centerline. MALS may also be installed with sequenced flashers — in this case, the system is referred to as MALSF.

**MILITARY OPERATIONS AREA (MOA):** A type of special use airspace of defined vertical and lateral dimensions established outside of Class A airspace to separate/segregate certain military activities from IFR traffic and to identify for VFR traffic where these activities are conducted. (AIM)

**MINIMUM DESCENT ALTITUDE (MDA):** The lowest altitude, expressed in feet above mean sea level, to which descent is authorized on final approach or during circle-to-land maneuvering in execution of a standard instrument approach procedure where no electronic glide slope is provided. (FAR 1)

**MISSED APPROACH:** A maneuver conducted by a pilot when an instrument approach cannot be completed to a landing. (AIM)

**NAVIGATIONAL AID/NAVAID:** Any visual or electronic device airborne or on the surface which provides point-to-point guidance information or position data to aircraft in flight. (AIM)

**NONDIRECTIONAL BEACON (NDB):** A 4 MF or UHF radio beacon transmitting nondirectional signals whereby the pilot of an aircraft equipped with direction finding equipment can determine his bearing to or from the radio beacon and "home" on or track to or from the station. (AIM)

**NONPRECISION APPROACH PROCEDURE:** A standard instrument approach procedure in which no electronic glide slope is provided. (FAR 1)

**NONPRECISION INSTRUMENT RUNWAY:** A runway with an instrument approach procedure utilizing air navigation facilities, with only horizontal guidance, or area-type navigation equipment for which a straight-in nonprecision instrument approach procedure has been approved or planned, and no precision approach facility or procedure is planned. (Airport Design)

**OBJECT FREE AREA (OFA):** A surface surrounding runways, taxiways, and taxilanes which should be clear of parked airplanes and objects except for objects that need to be located in the OFA for air navigation or aircraft ground maneuvering purposes. (Airport Design)

**OBSTACLE:** An existing object, object of natural growth, or terrain at a fixed geographical location, or which may be expected at a fixed location within a prescribed area, with reference to which vertical clearance is or must be provided during flight operation. (AIM)

---

**OBSTACLE FREE ZONE (OFZ):** A defined volume of airspace above and adjacent to a runway and its approach lighting system if one exists, free of all fixed objects except FAA-approved frangible aeronautical equipment and clear of vehicles and aircraft in the proximity of an airplane conducting an approach, missed approach, landing, takeoff, or departure.

**OBSTRUCTION:** An object/obstacle, including a mobile object, exceeding the obstruction standards specified in FAR Part 77, Subpart C. (AIM)

**OUTER MARKER:** A marker beacon at or near the glide slope intercept position of an ILS approach. (AIM)

**PRECISION APPROACH PATH INDICATOR (PAPI):** An airport visual landing aid similar to a VASI, but which has light units installed in a single row rather than two rows.

**PRECISION APPROACH PROCEDURE:** A standard instrument approach procedure in which an electronic glide slope is provided, such as an ILS or PAR. (FAR 1)

**PRECISION INSTRUMENT RUNWAY:** A runway with an instrument approach procedure utilizing an instrument landing system (ILS), microwave landing system (MLS), or precision approach radar (PAR). (Airport Design)

**RELOCATED THRESHOLD:** The portion of pavement behind a relocated threshold that is not available for takeoff and landing. It may be available for taxiing and aircraft. (Airport Design)

**REMOTE COMMUNICATIONS AIR/GROUND FACILITY (RCAG):** An unmanned VHF/UHF transmitter/receiver facility which is used to expand ARTCC air/ground communications coverage and to facilitate direct contact between pilots and controllers. (AIM)

**REMOTE COMMUNICATIONS OUTLET (RCO) AND REMOTE TRANSMITTER/ RECEIVER (RTR):** An unmanned communications facility remotely controlled by air traffic personnel. RCO's serve FSS's. RTR's serve terminal ATC facilities. (AIM)

**RESTRICTED AREA:** Designated airspace within which the flight of aircraft, while not wholly prohibited, is subject to restriction. (FAR 1)

**RUNWAY CLEAR ZONE:** A term previously used to describe the runway protection zone.

**RUNWAY EDGE LIGHTS:** Lights used to define the lateral limits of a runway. Specific types include:

- **HIRL**—High-Intensity Runway Lights.
- **MIRL**—Medium-Intensity Runway Lights.

**RUNWAY END IDENTIFIER LIGHTS (REIL):** Two synchronized flashing lights, one on each side of the runway threshold, which provide a pilot with a rapid and positive visual identification of the approach end of a particular runway. (AIM)

**RUNWAY PROTECTION ZONE (RPZ):** A trapezoidal shaped area at the end of a runway, the function of which is to enhance the protection of people and property on the ground through airport owner control of the land. The RPZ usually begins at the end of each primary surface and is centered upon the extended runway centerline. (Airport Design)

**RUNWAY SAFETY AREA (RSA):** A defined surface surrounding the runway prepared or suitable for reducing the risk of damage to airplanes in the event of an undershoot, overshoot, or excursion from the runway. (Airport Design)

**SMALL AIRCRAFT:** An aircraft of 12,500 pounds or less maximum certificated takeoff weight. (FAR 1)

---

**SPECIAL USE AIRSPACE:** Airspace of defined horizontal and vertical dimensions identified by an area on the surface of the earth wherein activities must be confined because of their nature and/or wherein limitations may be imposed upon aircraft operations that are not a part of those activities. (AIM)

**STANDARD INSTRUMENT DEPARTURE (SID):** A preplanned instrument flight rules (IFR) air traffic control departure procedure printed for pilot use in graphic and/or textual form. SID's provide transition from the terminal to the appropriate en route structure. (AIM)

**STANDARD TERMINAL ARRIVAL ROUTE (STAR):** A preplanned instrument flight rule (IFR) air traffic control arrival route published for pilot use in graphic and/or textual form. STARs provide transition from the en route structure to an outer fix or an instrument approach fix/arrival waypoint in the terminal area. (AIM)

**STOPWAY:** An area beyond the takeoff runway, no less wide than the runway and centered upon the extended centerline of the runway, able to support the airplane during an aborted takeoff, without causing structural damage to the airplane, and designated by the airport authorities for use in decelerating the airplane during an aborted takeoff. (FAR 1)

**STRAIGHT-IN INSTRUMENT APPROACH — IFR:** An instrument approach wherein final approach is begun without first having executed a procedure turn; it is not necessarily completed with a straight-in landing or made to straight-in landing weather minimums. (AIM)

**TAXILANE:** The portion of the aircraft parking area used for access between taxiways, aircraft parking positions, hangars, storage facilities, etc. (Airport Design)

**TAXIWAY:** A defined path, from one part of an airport to another, selected or prepared for the taxiing of aircraft. (Airport Design)

**TERMINAL INSTRUMENT PROCEDURES (TERPS):** Procedures for instrument approach and departure of aircraft to and from civil and military airports. There are four types of terminal instrument procedures: precision approach, nonprecision approach, circling, and departure.

**TERMINAL RADAR SERVICE AREA (TRSA):** Airspace surrounding designated airports wherein ATC provides radar vectoring, sequencing, and separation on a full-time basis for all IFR and participating VFR aircraft. (AIM)

**THRESHOLD:** The beginning of that portion of the runway usable for landing. (AIM)

**TOUCH-AND-GO:** An operation by an aircraft that lands and departs on a runway without stopping or exiting the runway. A touch-and-go is defined as two operations. (AIM)

**TRAFFIC PATTERN:** The traffic flow that is prescribed for aircraft landing at, taxiing on, or taking off from an airport. The components of a typical traffic pattern are upwind leg, crosswind leg, downwind leg, base leg, and final approach. (AIM)

**TRANSIENT AIRCRAFT:** Aircraft not based at the airport.

**TRANSMISSOMETER:** An apparatus used to determine visibility by measuring the transmission of light through the atmosphere. (AIM)

**UNCONTROLLED AIRSPACE:** Now known as Class G airspace. Class G airspace is that portion of the airspace that has not been designated as Class A, Class B, Class C, Class D, and Class E airspace.

**UNICOM (Aeronautical Advisory Station):** A nongovernment air/ground radio communication facility which may provide airport information at certain airports. (AIM)

---

**VERY-HIGH-FREQUENCY OMNIDIRECTIONAL RANGE (VOR):** The standard navigational aid used throughout the airway system to provide bearing information to aircraft. When combined with Distance Measuring Equipment (DME) or Tactical Air Navigation (TACAN) the facility, called VOR-DME or VORTAC, provides distance as well as bearing information.

**VISUAL APPROACH SLOPE INDICATOR (VASI):** An airport landing aid which provides a pilot with visual descent (approach slope) guidance while on approach to landing. Also see PAPI.

**VISUAL FLIGHT RULES (VFR):** Rules that govern the procedures for conducting flight under visual conditions. The term "VFR" is also used by pilots and controllers to indicate type of flight plan. (AIM)

**VISUAL GLIDE SLOPE INDICATOR (VGS):** A generic term for the group of airport visual landing aids which includes Visual Approach Slope Indicators (VASI), Precision Approach Path Indicators (PAPI), and Pulsed Light Approach Slope Indicators (PLASI). When FAA funding pays for this equipment, whichever type receives the lowest bid price will be installed unless the airport owner wishes to pay the difference for a more expensive unit.

**VISUAL RUNWAY:** A runway intended solely for the operation of aircraft using visual approach procedures, with no straight-in instrument approach procedure and no instrument designation indicated on an FAA-approved airport layout plan. (Airport Design)

**WARNING AREA:** A type of special use airspace which may contain hazards to nonparticipating aircraft in international airspace. (AIM)

## SOURCES

**FAR 1:** Federal Aviation Regulations Part 1, Definitions and Abbreviations. (1993)

**AIM:** Airman's Information Manual, Pilot/Controller Glossary. (1993)

**Airport Design:** Federal Aviation Administration. *Airport Design*. Advisory Circular 150/5300-13, Change 7. (2002)

**FAA ATA:** Federal Aviation Administration. *Air Traffic Activity*. (1986)

**FAA Census:** Federal Aviation Administration. *Census of U.S. Civil Aircraft*. (1986)

**FAA Stats:** Federal Aviation Administration. *Statistical Handbook of Aviation*. (1984)

**NTSB:** National Transportation Safety Board. *U.S. NTSB 830-3*. (1989)





**APPENDIX B**

---

**AIRCRAFT OWNER SURVEY**



# Aircraft Owner Survey Summary

---

## OVERVIEW

In an effort to assess the potential user demand for Crows Landing Airport (Airport), Aviation Management Consulting Group (AMCG) and Mead & Hunt developed and implemented an Aircraft Owner Survey (Survey) of aircraft owners located within a 40 nautical mile radius of the Airport, and piston, turboprop, and turbojet aircraft owners within a 75 nautical mile radius of the Airport. A total of 922 postcards were mailed to aircraft owners (690 to piston aircraft owners and 232 to turboprop and turbojet aircraft owners) inviting them to participate in the Survey.

The Survey was made available for completion and submission on a dedicated website created and managed by AMCG. The postcards inviting aircraft owner participation were mailed on January 4, 2006. Hardcopies of the Survey were also made available to aircraft owners upon request. The response deadline for the Survey was January 27, 2006. As an incentive to complete and submit the Survey, each respondent to the Survey was offered the opportunity to be entered into a drawing for the chance to win an aviation gift certificate valued at \$250.

Of the 922 postcards mailed 76 postcards (8.2%), 64 addressed to piston aircraft owners and 12 addressed to turboprop and turbojet aircraft owners) were returned due to erroneous addresses. This erroneous address rate is not surprising considering the FAA's registration methodology and the frequent changes in some aircraft ownership arrangements. Therefore, the total number of Surveys "received" by aircraft owners equaled 846 (626 piston aircraft owners and 220 turboprop and turbojet aircraft owners).

The Survey, developed by AMCG and Mead & Hunt, was designed to assess the factors that influence aircraft owners within the Airport market on their selection of home (based) airports, and the potential for Survey respondents (aircraft owners) to relocate their aircraft to the Airport. Under the first section of the Survey (Questions 1-22), respondents were asked to rate influencing factors from 1 (unimportant) to 6 (very important). The second section of the Survey allowed respondents to select among various response options to answer questions about their interest level in relocating to the Airport, building a hangar on the Airport, or starting a business on the Airport. Finally, respondents were offered the opportunity to express any "additional comments" in written form.

A total of 55 Survey responses were received (54 from piston aircraft owners and only 1 from a turbojet aircraft owner). This equates to a total response rate of 6.5% (8.6% piston aircraft owners and 0.5% turboprop or turbojet aircraft owners) of the total Surveys "received".

A 10% to 20% response rate is generally considered typical for airport related surveys. These surveys typically survey airport users (aircraft owners) that are based at the subject airport and therefore have a vested interest in the outcome of the survey results. Statistically, a 10% to 20% response rate is sufficient to draw reasonable correlation to the other airport users (aircraft owners). However, since the aircraft owners surveyed in this Survey do not have a direct vested interest in the Airport, it is not surprising to see the lower response rate. In fact, in reviewing the FAA's aircraft owners list it appears

that there could be numerous financing and leasing companies that "own" turboprop and turbojet aircraft that most likely are not operating the aircraft that they own and therefore would have little to no interest in responding to the Survey.

However, since nearly all respondents were piston aircraft owners, an 8.6% response rate is nearing the lower acceptable response rate level to draw reasonable correlations. However, we would caution the County on extrapolating the results of this survey over the entire population of 626 piston aircraft owners.

Following are some highlights of the 55 survey responses received:

- Aircraft owners own a total of 69 aircraft (64 single engine piston aircraft, four multi-engine piston aircraft, and one turbojet powered aircraft).
- Forty-eight (48) aircraft owners (87%) operate their aircraft solely for non-commercial purposes.
- Zero (0) aircraft owners operate their aircraft solely for commercial purposes only.
- Five (5) aircraft owners (9%) operate their aircraft for both commercial and non-commercial purposes.
- Two (2) aircraft owners (4%) did not specify the use of their aircraft.
- Fifty-six (56) aircraft (81%) are based within 40 miles of Crows Landing Airport.

## Conclusions

The following conclusions are based on a combined review and analysis of the Survey responses by AMCG and Mead & Hunt.

The first 21 questions of the Survey assessed the importance of factors which influence the decision of aircraft owners on where to base their aircraft. Within the responses to these questions, there were no surprises. The respondents to the Survey were primarily non-commercial (recreational/pleasure and business) owners of small, piston aircraft who have a rather predictable array of important factors, including fuel availability and price, aircraft storage availability and price, roadway access, vehicle parking availability, and basic airfield components such as lighting.

The last nine questions allowed the respondent to choose options regarding their interest level in relocating their aircraft to Crows Landing Airport, building a facility at the Airport, and establishing a business at the Airport. Of the responses received, there seemed to be a relatively high amount of interest in relocating to Crows Landing Airport and establishing a business at the Airport. Of the responses received, there seemed to be a relatively high amount of interest in relocating to Crows Landing Airport and establishing facilities or businesses there. According to the additional testimonial comments, this interest was in large part conditional on price of products/services/facilities offered at the Airport. This is to be expected when considering that the vast majority of the respondents were non-commercial (recreational/pleasure and business) aircraft owners and operators who are typically very price sensitive.

Based upon the findings of this survey, AMCG and Mead & Hunt believe it is reasonable to project that approximately 15 to 20 aircraft may relocate to Crows Landing Airport within the first year of the Airport's operation as a public use airport. Additional aircraft, primarily small, piston aircraft, may relocate to the Airport in subsequent years, as services and facilities at the Airport are further developed.

### **Additional Observations by Mead & Hunt**

Overall, we found the Survey process and subsequent responses to be fully consistent with our initial expectations and experience. Our specific observations and reactions regarding the Survey (over and above our analysis as presented in the survey analysis report) are as follows:

- The relatively low Total Response Rate of 6.5% was about as we expected. We surveyed general aviation aircraft owners in the vicinity of Crows Landing Airport (both personal/recreational aircraft and business/corporate aircraft owners) – none of whom has a vested interest in the Airport. Therefore, their interest in responding to the survey would likely be minimal.
- The large majority of responses received were from personal/recreational aircraft owners who are typically very price sensitive. Such owners would likely consider relocating to another airport only if their operating costs (e.g., hangar, fuel, maintenance, etc.) at the new airport were significantly lower than the costs at their current base of operations.
- It is our expectation that Crows Landing Airport can be developed and operated as a publicly-owned/public-use general aviation airport that complies with federal (Federal Aviation Administration – FAA) and state (California Division of Aeronautics – CDOA) design standards and operational requirements.
- We believe it reasonable to project that approximately 15 to 20 aircraft may relocate to Crows Landing Airport within the first year of the Airport's operation as a basic (i.e., at least one hard-surface runway, night lighting, security, basic storage hangars, and fuel) public-use general aviation facility. If the Airport is to attract additional based and transient aircraft, it will have to be further improved with instrument approach capability (initially, GPS based nonprecision), aircraft maintenance services, and more storage hangars. In addition, planned commercial development in the area surrounding the Airport will likely lead to increased aviation activity at the Airport in the years ahead.
- To qualify for airport planning and development grants from the FAA, an airport must be included in the FAA's National Plan for Integrated Airport Systems (NPIAS). Crows Landing Airport, as a former military-use only facility, is not currently listed in the NPIAS. To be considered for inclusion within the NPIAS, an airport must usually have at least ten (10) locally-based aircraft. However, this activity criterion may be relaxed by the FAA for a remote location or other mitigating circumstances.
- Considering that some 67% (37 respondents) of the Survey respondents were moderately-to-very interested in relocating to (i.e., basing their aircraft at) Crows Landing Airport, we believe it reasonable to project that approximately 15 to 20 aircraft may relocate to Crows Landing Airport within the first year of the Airport's operation. We suggest that this level of anticipated based aircraft activity is sufficient to justify the inclusion of Crows Landing Airport as a General Aviation facility within the current NPIAS.



**APPENDIX C**

---

**AIRPORT LAYOUT PLAN DRAWINGS**





# Crows Landing Airport Airport Layout Plan

Stanislaus County, California  
February 2017



SHEET INDEX

1. INDEX
2. AIRPORT LAYOUT PLAN
3. AIRPORT DATA
4. PART 77 AIRSPACE PLAN
5. INNER APPROACH PLAN & PROFILE
6. EXHIBIT 'A' PROPERTY MAP



SUBMITTED BY:  
COUNTY OF STANISLAUS

By \_\_\_\_\_

Title \_\_\_\_\_ Date \_\_\_\_\_

3	Bell Road Accommodation	Mead & Hunt, Inc.	Oct. 2014
2	Single Runway Configuration	Mead & Hunt, Inc.	Mar. 2012
1	First ALP for Airport	Mead & Hunt, Inc.	Dec. 2008
NO.	REVISION	SPONSOR	DATE

**CROWS LANDING AIRPORT  
STANISLAUS COUNTY, CALIFORNIA**

**INDEX**



133 Aviation Boulevard, Suite 100  
Santa Rosa, California 95403  
(707) 528-5010  
Fax: (707) 528-9721  
www.meadhunt.com



DESIGN:	BM/DH	DRAWN:	TE/DH/BM	DATE:	February 2017	SHEET	1	OF	6
---------	-------	--------	----------	-------	---------------	-------	---	----	---

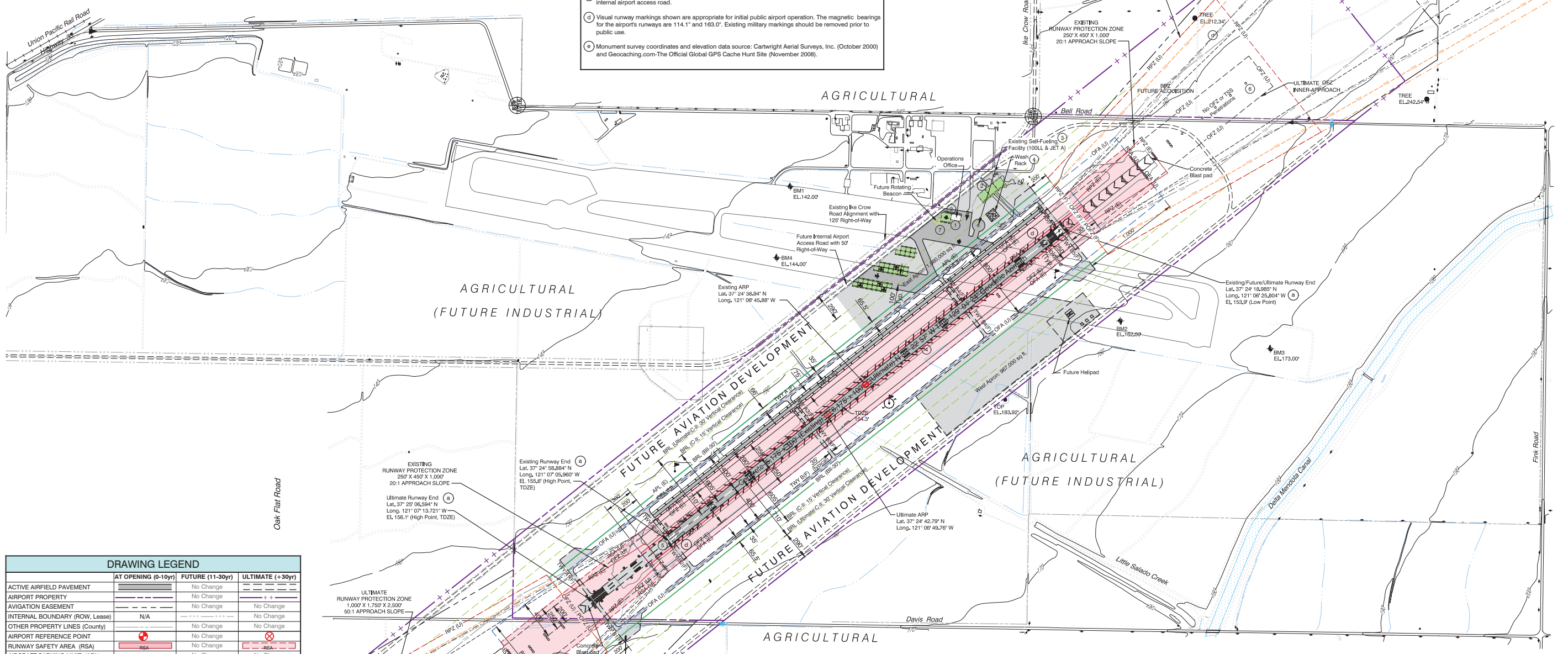
The preparation of this document may have been supported, in part, through the Airport Improvement Program financial assistance from the Federal Aviation Administration (Project Number Unassigned) as provided under Title 49 U.S.C., Section 47104. The contents do not in any way constitute a commitment on the part of the United States to participate in any development depicted therein nor does it indicate that the proposed development is environmentally acceptable or would have justification in accordance with appropriate public laws.

BUILDING AND FACILITY LEGEND	
FACILITY	ELEVATION
① Future Operations Office	162'
② Fixed Base Operator (FBO)	162'
③ Fuel Facility	N/A
④ Future Wash Rack	N/A
⑤ Future Runway End Indicator Lights (REILS)	N/A
⑥ Future Medium Intensity Approach Light System With Rail (MALS/R)	N/A
⑦ Future Rotating Beacon	197'

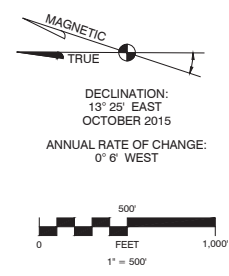
MONUMENTS					
ID #	LATITUDE	LONGITUDE	ELEVATION	DESCRIPTION	
1	HS5483	37° 24' 46.766" N	121° 06' 20.756" W	142.00'	Brass survey disk
2	HS5478	37° 24' 13.062" N	121° 06' 37.571" W	162.00'	Brass survey disk
3	HS5474	37° 23' 57.775" N	121° 06' 40.989" W	173.00'	Stainless steel rod
4	HS5477	37° 24' 48.034" N	121° 06' 29.765" W	144.00'	Brass survey disk

**ALP NOTES**

- ALP prepared using design criteria from FAA Advisory Circulars 150/5300-13A Change 1, "Airport Design", 150/5070-6A, FAA Standard Operating Procedures 2.00 and 3.00, and Part 77 of the Federal Aviation Regulations (FAR), "Safe, Efficient Use, and Preservation of the Navigable Airspace."
- Magnetic Declination source: National Geophysical Data Center.
- ① Airport coordinate and elevation data source: Photogrammetric survey conducted by Cartwright Aerial Surveys, Inc. (October 2000) and field survey by Mead & Hunt, Inc. (October 2008). Coordinates are NAD83. Elevations are NAVD83. Geodetic Azimuth is reckoned clockwise from true north.
- ② See Sheets 4 and 5 for more information on Threshold Siting Surfaces (TSS), Part 77 Surfaces and obstruction data.
- ③ Runway threshold located to meet Runway Object Free Area standards with respect to the proposed internal airport access road.
- ④ Visual runway markings shown are appropriate for initial public airport operation. The magnetic bearings for the airport's runways are 114.1° and 163.0°. Existing military markings should be removed prior to public use.
- ⑤ Monument survey coordinates and elevation data source: Cartwright Aerial Surveys, Inc. (October 2000) and Geocaching.com-The Official Global GPS Cache Hunt Site (November 2008).



DRAWING LEGEND			
	AT OPENING (0-10yr)	FUTURE (11-30yr)	ULTIMATE (+30yr)
ACTIVE AIRFIELD PAVEMENT	[Symbol]	No Change	[Symbol]
AIRPORT PROPERTY	[Symbol]	No Change	[Symbol]
AVIGATION EASEMENT	[Symbol]	No Change	[Symbol]
INTERNAL BOUNDARY (ROW, Lease)	N/A	No Change	No Change
OTHER PROPERTY LINES (County)	[Symbol]	No Change	No Change
AIRPORT REFERENCE POINT	[Symbol]	No Change	[Symbol]
RUNWAY SAFETY AREA (RSA)	[Symbol]	No Change	[Symbol]
AIRCRAFT PARKING LIMIT (APL)	[Symbol]	No Change	[Symbol]
BUILDING RESTRICTION LINE (BRL)	[Symbol]	No Change	[Symbol]
RUNWAY PROTECTION ZONE (RPZ)	[Symbol]	No Change	[Symbol]
OBJECT FREE AREA (OFA)	[Symbol]	No Change	[Symbol]
OBSTACLE FREE ZONE (OFZ)	[Symbol]	No Change	[Symbol]
PRECISION OBSTACLE FREE ZONE	N/A	No Change	[Symbol]
PART 77 AIRSPACE APPROACH	[Symbol]	No Change	[Symbol]
THRESHOLD SITING SURFACE (TSS)	[Symbol]	No Change	[Symbol]
BUILDING	[Symbol]	No Change	[Symbol]
HELIPAD	N/A	No Change	No Change
PUBLIC ROAD	[Symbol]	No Change	[Symbol]
DIRT OR GRAVEL ROAD	[Symbol]	No Change	[Symbol]
FENCE	[Symbol]	No Change	[Symbol]
VEHICLE GATE	[Symbol]	No Change	[Symbol]
WIND CONE	[Symbol]	No Change	[Symbol]
LIGHTS: SINGLE/GROUP/FLASHING	N/A	[Symbol]	[Symbol]
ROTATING BEACON	N/A	[Symbol]	[Symbol]
UTILITY POLE / POWER LINE	[Symbol]	No Change	[Symbol]
CHANNEL / WATERWAY / CULVERT	[Symbol]	No Change	[Symbol]
TOPOGRAPHIC CONTOURS	[Symbol]	No Change	[Symbol]
MONUMENT	[Symbol]	No Change	[Symbol]
SECTION CORNER	[Symbol]	No Change	[Symbol]



SUBMITTED BY: County of Stanislaus, California

By \_\_\_\_\_ Date \_\_\_\_\_

3	Bell Road Accommodation	Mead & Hunt, Inc.	Oct. 2014
2	Single Runway Configuration	Mead & Hunt, Inc.	Mar. 2012
1	First ALP for Airport	Mead & Hunt, Inc.	Dec. 2008
NO.	REVISION	SPONSOR	DATE

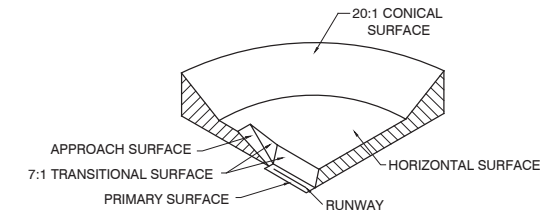
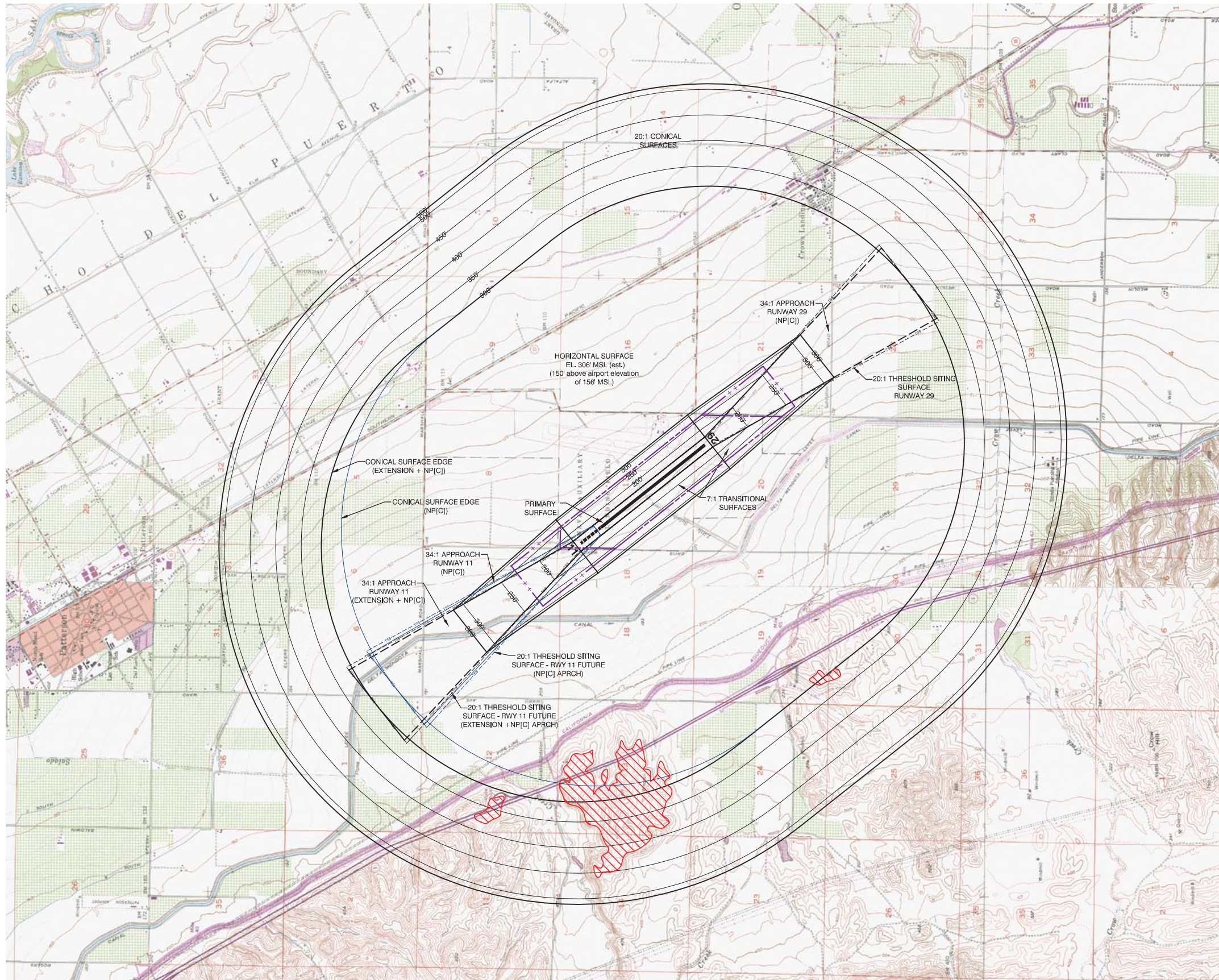
**CROWS LANDING AIRPORT**  
STANISLAUS COUNTY, CALIFORNIA

**AIRPORT LAYOUT PLAN**

**Mead & Hunt**  
133 Aviation Boulevard, Suite 100  
Santa Rosa, California 95403  
(707) 526-5010  
Fax (707) 526-9721  
www.meadhunt.com

DESIGN: BM/DH DRAWN: TE/DH/BM DATE: February 2017 SHEET 2 OF 6





**TYPICAL FAR PART 77 SURFACES**

**LEGEND**

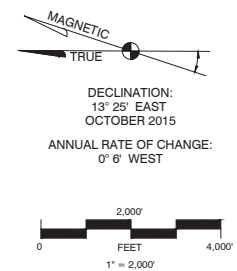
- Existing Runway
- Future Runway Extension
- FAR Part 77 Surfaces (Future with Non Precision Approach and Runway Extension)
- FAR Part 77 Surfaces (Future with Non Precision Approach)
- Threshold Siting Surface (TSS) (Future with Non Precision Approach)
- Threshold Siting Surface (TSS) (Future with Non Precision Approach and Runway Extension)
- Airport Property Boundary (Existing)
- Airport Property Boundary (Future)
- Terrain Contours
- Part 77 Surface Penetration Estimated

**NOTES:**

- Airspace surfaces shown for Future Phase (30 year plan) configuration of the Airport. This includes Non-Precision instrument approaches to a greater than utility/runway (NP[C]). For interests of land use protection, Airspace Plan also includes 1,000' extension to the approach end of Runway 11. See ALP sheets 2 and 3 for more information on phasing.
- All elevations in feet above mean sea level (MSL).

**SOURCES:**

USGS Topographic Maps.  
 Photogrammetric Survey by Cartwright Aerial Surveys, Inc. (Oct. 2000) and  
 Field Survey by Mead & Hunt, Inc. (October 2008)



3	Bell Road Accommodation	Mead & Hunt, Inc.	Oct. 2014
2	Single Runway Configuration	Mead & Hunt, Inc.	Mar. 2012
1	First ALP for Airport	Mead & Hunt, Inc.	Dec. 2008
NO.	REVISION	SPONSOR	DATE

**CROWS LANDING AIRPORT  
 STANISLAUS COUNTY, CALIFORNIA**

**PART 77 AIRSPACE PLAN**

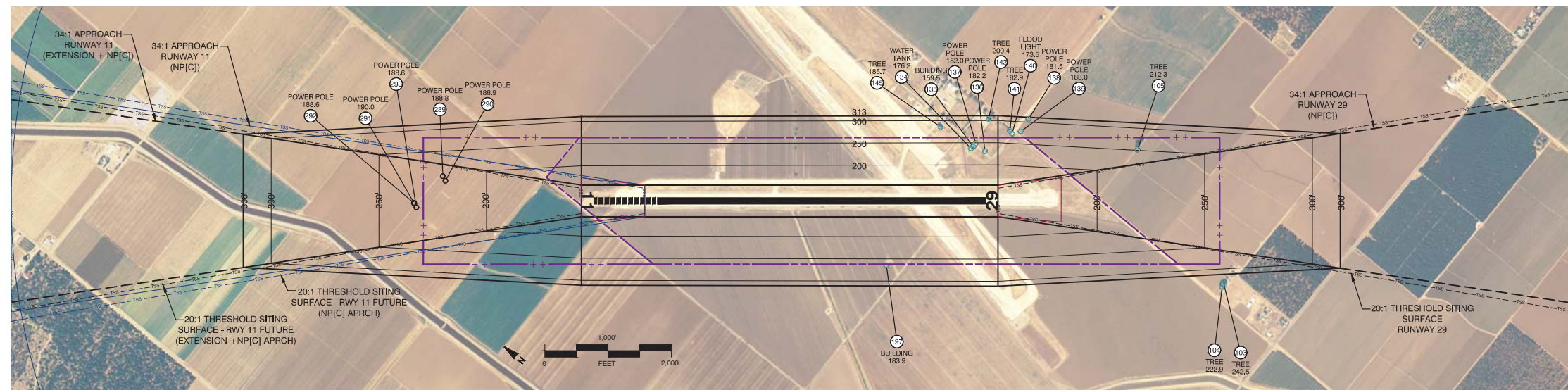


133 Aviation Boulevard, Suite 100  
 Santa Rosa, California 95403  
 (707) 528-5010  
 Fax: (707) 528-9121  
 www.meadhunt.com



DESIGN:	BM/DH	DRAWN:	TE/DH/BM	DATE:	February 2017	SHEET	4	OF	6
---------	-------	--------	----------	-------	---------------	-------	---	----	---

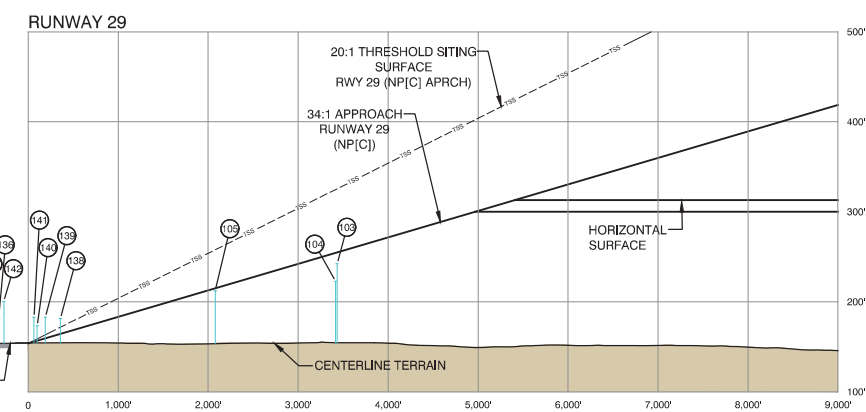
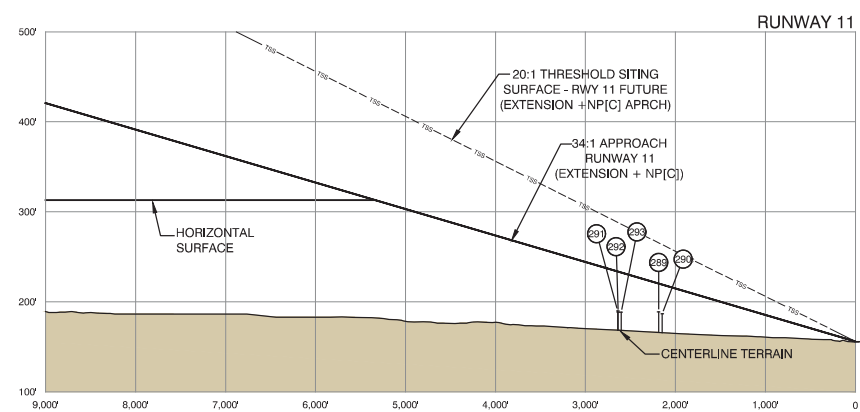
The preparation of this document may have been supported, in part, through the Airport Improvement Program financial assistance from the Federal Aviation Administration (Project Number Unassigned) as provided under Title 49 U.S.C., Section 47104. The contents do not in any way constitute a commitment on the part of the United States to participate in any development depicted therein nor does it indicate that the proposed development is environmentally acceptable or would have justification in accordance with appropriate public laws.



- LEGEND**
- Existing Runway
  - Future Runway Extension
  - FAR Part 77 Surfaces (Future with Non Precision Approach and Runway Extension)
  - FAR Part 77 Surfaces (Future with Non Precision Approach)
  - Threshold Sitting Surface (TSS) (Future with Non Precision Approach)
  - Threshold Sitting Surface (TSS) (Future with Non Precision Approach and Runway Extension)
  - Airport Property Boundary (Existing)
  - Airport Property Boundary (Future)
  - Object penetrates indicated surface.
  - Object falls outside or below indicated surface.
  - Poles estimated to be 30 feet in height.
  - \*\* 15 feet vertical clearance added to road elevations and 17 feet vertical clearance added to railroads.

- NOTES:**
- Airspace surfaces shown for Future Phase (30 year plan) configuration of the Airport. This includes Non-Precision instrument approaches to a 'greater than utility' runway (NP[C]). For interests of land use protection, Airspace Plan also includes 1,000' extension to the approach end of Runway 11. See ALP sheets 2 and 3 for more information on phasing.
  - All elevations in feet above mean sea level (MSL).

**SOURCES:**  
 USGS Topographic Maps.  
 Photogrammetric Survey by Cartwright Aerial Surveys, Inc. (Oct. 2000) and  
 Field Survey by Mead & Hunt, Inc. (October 2008)



OBSTRUCTION DATA								
POINT #	DESCRIPTION	TOP ELEVATION IN FEET (MSL)	AFFECTED PART 77 SURFACE	PART 77 SURFACE ELEVATION	PART 77 SURFACE PENETRATION	THRESHOLD SITING SURFACE ELEVATION	THRESHOLD SITING SURFACE PENETRATION	DISPOSITION
103	TREE	242.5	HORIZONTAL	313.0	-70.5	N/A	N/A	-
104	TREE	222.9	HORIZONTAL	313.0	-90.1	N/A	N/A	-
105	TREE	212.3	TRANSITIONAL	251.0	-38.7	N/A	N/A	-
134	WATER TANK	178.2	TRANSITIONAL	238.0	-61.8	N/A	N/A	-
135	BUILDING	159.5	TRANSITIONAL	240.0	-80.5	N/A	N/A	-
136	POWER POLE	182.2	TRANSITIONAL	231.0	-48.8	N/A	N/A	-
137	POWER POLE	182.0	TRANSITIONAL	249.0	-67.0	N/A	N/A	-
138	POWER POLE	181.5	TRANSITIONAL	307.0	-125.5	N/A	N/A	-
139	POWER POLE	183.0	TRANSITIONAL	278.0	-95.0	N/A	N/A	-
140	FLOOD LIGHT	173.5	TRANSITIONAL	272.0	-98.5	N/A	N/A	-
141	TREE	182.9	TRANSITIONAL	278.0	-95.1	N/A	N/A	-
142	TREE	200.4	TRANSITIONAL	303.0	-102.6	N/A	N/A	-
145	TREE	185.7	TRANSITIONAL	250.0	-64.3	N/A	N/A	-
197	BUILDING	183.9	TRANSITIONAL	229.0	-45.1	N/A	N/A	-
289	POWER POLE	188.8	11 APPROACH	220.0	-31.2	219.9	-31.1	-
290	POWER POLE	186.9	11 APPROACH	219.0	-32.1	218.7	-31.9	-
291	POWER POLE	190.0	11 APPROACH	233.0	-43.1	233.3	-43.3	-
292	POWER POLE	188.6	11 APPROACH	233.0	-44.4	233.1	-44.6	-
293	POWER POLE	188.6	11 APPROACH	232.0	-43.4	232.2	-43.6	-

NO.	REVISION	SPONSOR	DATE
3	Bell Road Accommodation	Mead & Hunt, Inc.	Oct. 2014
2	Single Runway Configuration	Mead & Hunt, Inc.	Mar. 2012
1	First ALP for Airport	Mead & Hunt, Inc.	Dec. 2008

**CROWS LANDING AIRPORT**  
 STANISLAUS COUNTY, CALIFORNIA

**INNER APPROACH PLAN & PROFILE**

133 Aviation Boulevard, Suite 100  
 Santa Rosa, California 95403  
 (707) 526-5010  
 Fax (707) 526-9721  
 www.meadhunt.com

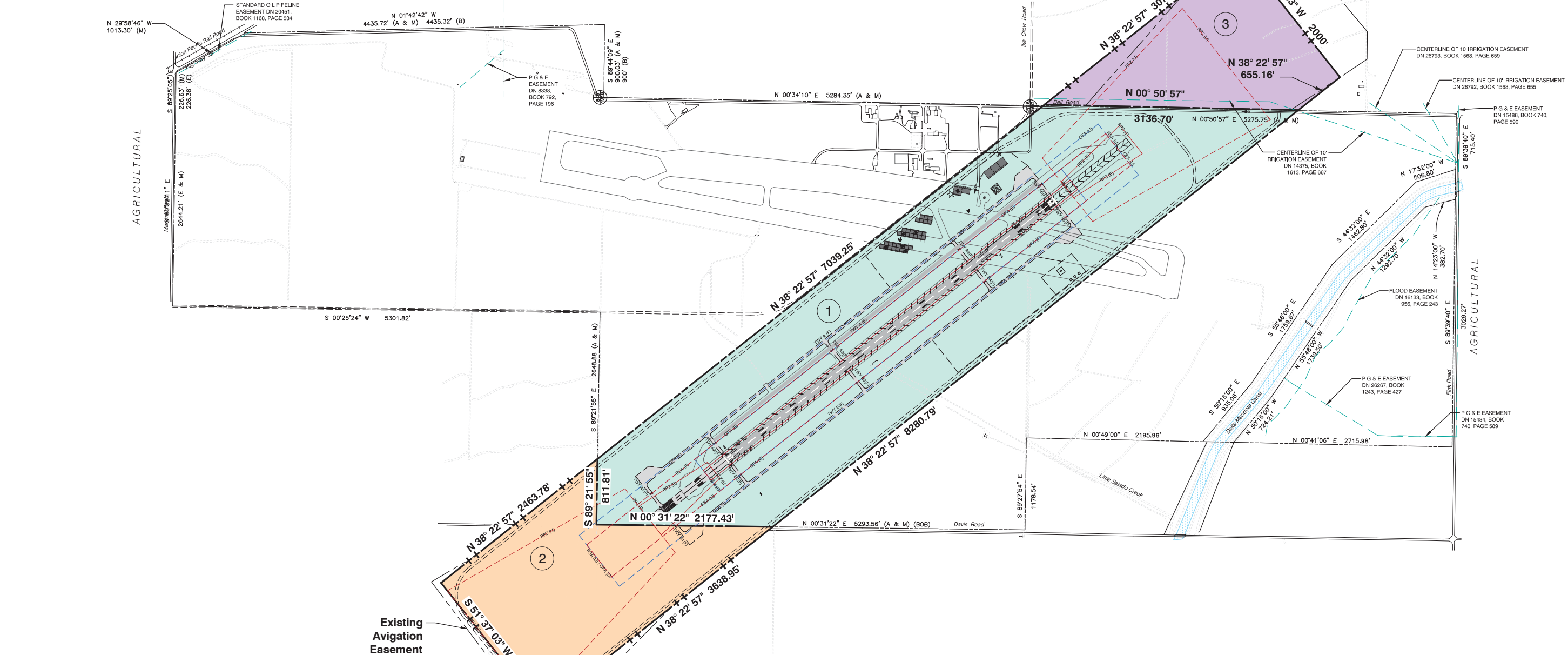
DESIGN: BM/DH    DRAWN: TE/DH/BM    DATE: February 2017    SHEET 5 OF 6

The preparation of this document may have been supported, in part, through the Airport Improvement Program financial assistance from the Federal Aviation Administration (Project Number Unassigned) as provided under Title 49 U.S.C., Section 47104. The contents do not in any way constitute a commitment on the part of the United States to participate in any development depicted therein nor does it indicate that the proposed development is environmentally acceptable or would have justification in accordance with appropriate public laws.

AIRPORT PARCEL DATA								
PARCEL ID #	ASSESSORS PARCEL NUMBER	ACRES (a)	DATE ACQUIRED	CONVEYANCE INSTRUMENT	TYPE OF INTEREST	FUNDING SOURCE	FAA GRANT NUMBER	GRANTOR
1	N/A	372	Oct. 27, 1999	Act of Congress	FEE SIMPLE	N/A	N/A	US Govt. / NASA (Public Law 106-82)
2	N/A	120			B E F	A C Q U I R E D		
3	N/A	86			B E F	A C Q U I R E D		

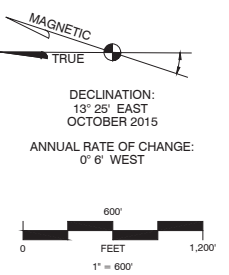
**EXHIBIT 'A' NOTES**

- Airport property boundary and data source: Stanislaus County. Property boundary and individual parcels survey by Aspen Survey Company, July 2004. Survey should not be considered a precise legal description. Best available data used.
- Total existing airport property equals ±372 acres. Total future airport property equals ±578 acres.
- (a) Acreage for individual parcels based on digital line work.



DRAWING LEGEND			
	EXISTING (0-10yr)	FUTURE (10-30yr)	ULTIMATE (+30yr)
ACTIVE AIRFIELD PAVEMENT	---	No Change	---
AIRPORT PROPERTY	---	No Change	+
AVIGATION EASEMENT	---	No Change	---
OTHER EASEMENTS	---	No Change	No Change
OTHER PROPERTY LINES (County)	---	No Change	No Change
RUNWAY SAFETY AREA (RSA)	--- RSA ---	No Change	--- RSA ---
RUNWAY PROTECTION ZONE (RPZ)	--- RPZ ---	No Change	--- RPZ ---
OBJECT FREE AREA (OFA)	--- OFA ---	No Change	--- OFA ---
BUILDING	---	No Change	No Change
HELIPAD	N/A	H	No Change
PUBLIC ROAD	---	---	No Change
DIRT OR GRAVEL ROAD	---	No Change	No Change
CHANNEL / WATERWAY / CULVERT	---	No Change	No Change
SECTION CORNER	---	No Change	No Change

**Existing Avigation Easement**  
 (A PERPETUAL EASEMENT FOR THE ESTABLISHMENT, MAINTENANCE, OPERATION AND USE OF A CRASH SAFETY ZONE)



NO.	REVISION	SPONSOR	DATE
3	Bell Road Accommodation	Mead & Hunt, Inc.	Oct. 2014
2	Single Runway Configuration	Mead & Hunt, Inc.	Mar. 2012
1	First ALP for Airport	Mead & Hunt, Inc.	Dec. 2008

**CROWS LANDING AIRPORT**  
**STANISLAUS COUNTY, CALIFORNIA**

**EXHIBIT 'A' PROPERTY MAP**

**Mead & Hunt**  
 133 Aviation Boulevard, Suite 100  
 Santa Rosa, California 95403  
 (707) 528-5010  
 Fax: (707) 528-9721  
 www.meadhunt.com

DESIGN: BM/DH	DRAWN: TE/DH/BM	DATE: February 2017	SHEET 6 OF 6
---------------	-----------------	---------------------	--------------

The preparation of this document may have been supported, in part, through the Airport Improvement Program financial assistance from the Federal Aviation Administration (Project Number Unassigned) as provided under Title 49 U.S.C., Section 47104. The contents do not in any way constitute a commitment on the part of the United States to participate in any development depicted therein nor does it indicate that the proposed development is environmentally acceptable or would have justification in accordance with appropriate public laws.



Revised	By
UPDATED BY: PAUL SAINI, RCE DONAL HICKS, SR. ENGR. TECH	
CHECKED BY: DAVID LEAMON, RCE	

**60 FT LOCAL  
2 LANE RURAL**

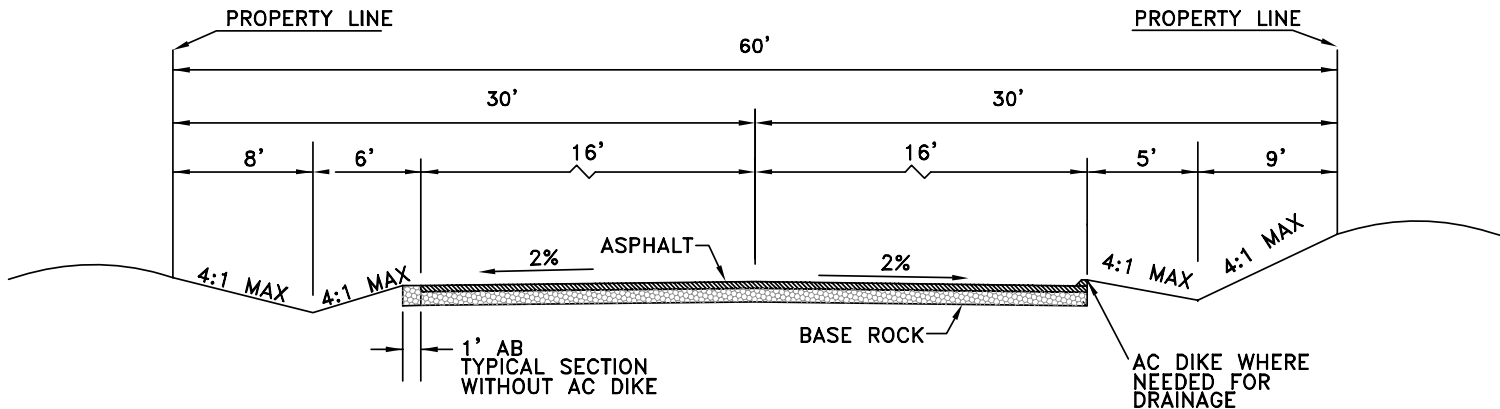
COUNTY OF STANISLAUS  
DEPARTMENT OF PUBLIC WORKS

APPROVED BY: *Matthew Machado*  
MATTHEW MACHADO  
DIRECTOR OF PUBLIC WORKS

DATE: JUNE 2, 2014

PLATE NO.: **3-A11**

## 60 FT LOCAL (2 LANE RURAL)



**NOTE:**

1. PAVEMENT CROSS SLOPE SHALL BE 2.0% MINIMUM ON NEW ROAD CONSTRUCTION.
2. PAVEMENT WIDTH LESS THAN 16 FT MAY REQUIRE POSTING OF "NO PARKING" SIGNS AS DIRECTED BY ENGINEER.
3. ADDITIONAL SLOPE EASEMENTS MAY BE REQUIRED FOR ADEQUATE GRADING AND/OR DRAINAGE.
4. INSTALL AC DIKE WHERE REQUIRED FOR DRAINAGE, SEE CROSS SECTION ABOVE.
5. UNDERGROUND FRENCH DRAIN MAYBE REQUIRED IN THE SWALE AREA TO HELP CONTROL DRAINAGE AND ENHANCE SAFETY.



Revised	By
UPDATED BY: PAUL SAINI, RCE DONAL HICKS, SR., ENGR. TECH	CHECKED BY: DAVID LEMMON, RCE

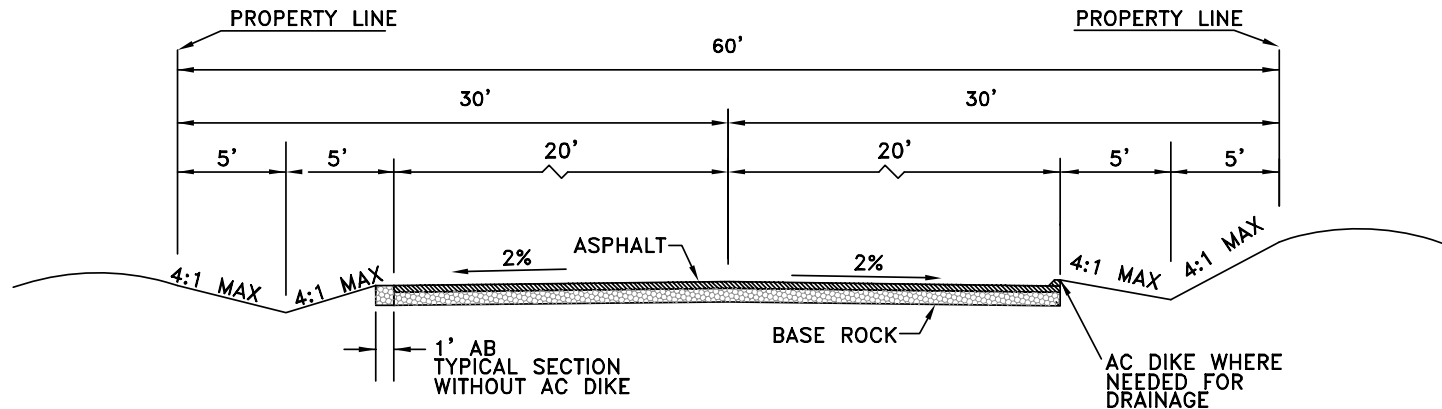
**60 FT MINOR COLLECTOR  
2 LANE RURAL**

COUNTY OF STANISLAUS  
DEPARTMENT OF PUBLIC WORKS

APPROVED BY: *[Signature]*  
MATTHEW MACHADO  
DIRECTOR OF PUBLIC WORKS

DATE: JUNE 2, 2014  
PLATE NO.: **3-A12**

## 60 FT MINOR COLLECTOR (2 LANE RURAL)



NOT TO SCALE

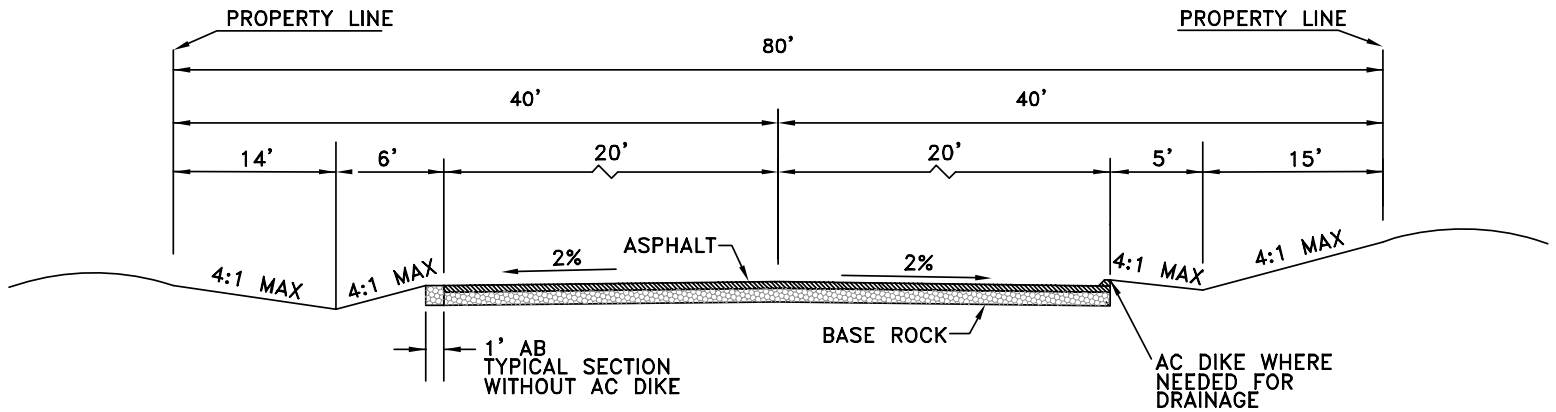
**NOTE:**

1. PAVEMENT CROSS SLOPE SHALL BE 2.0% MINIMUM ON NEW ROAD CONSTRUCTION.
2. PAVEMENT WIDTH LESS THAN 20 FT MAY REQUIRE POSTING OF "NO PARKING" SIGNS AS DIRECTED BY ENGINEER.
3. ADDITIONAL SLOPE EASEMENTS MAY BE REQUIRED FOR ADEQUATE GRADING AND/OR DRAINAGE.
4. INSTALL AC DIKE WHERE REQUIRED FOR DRAINAGE, SEE CROSS SECTION ABOVE.
5. UNDERGROUND FRENCH DRAIN MAYBE REQUIRED IN THE SWALE AREA TO HELP CONTROL DRAINAGE AND ENHANCE SAFETY.





## 80 FT MAJOR COLLECTOR (2 LANE RURAL)



NOT TO SCALE

**NOTE:**

1. PAVEMENT CROSS SLOPE SHALL BE 2.0% MINIMUM ON NEW ROAD CONSTRUCTION.
2. PAVEMENT WIDTH LESS THAN 20 FT MAY REQUIRE POSTING OF "NO PARKING" SIGNS AS DIRECTED BY ENGINEER.
3. ADDITIONAL SLOPE EASEMENTS MAY BE REQUIRED FOR ADEQUATE GRADING AND/OR DRAINAGE.
4. INSTALL AC DIKE WHERE REQUIRED FOR DRAINAGE, SEE CROSS SECTION ABOVE.
5. UNDERGROUND FRENCH DRAIN MAYBE REQUIRED IN THE SWALE AREA TO HELP CONTROL DRAINAGE AND ENHANCE SAFETY.

Revised	
By	
UPDATED BY: PAUL SAINI, RCE DONAL HICKS, SR., ENGR. TECH	
CHECKED BY: DAVID LEAMON, RCE	

**80 FT MAJOR COLLECTOR  
2 LANE RURAL**

COUNTY OF STANISLAUS  
DEPARTMENT OF PUBLIC WORKS

APPROVED BY:

*Matthew Machado*  
MATTHEW MACHADO  
DIRECTOR OF PUBLIC WORKS

DATE: JUNE 2, 2014

PLATE NO.: **3-A13**

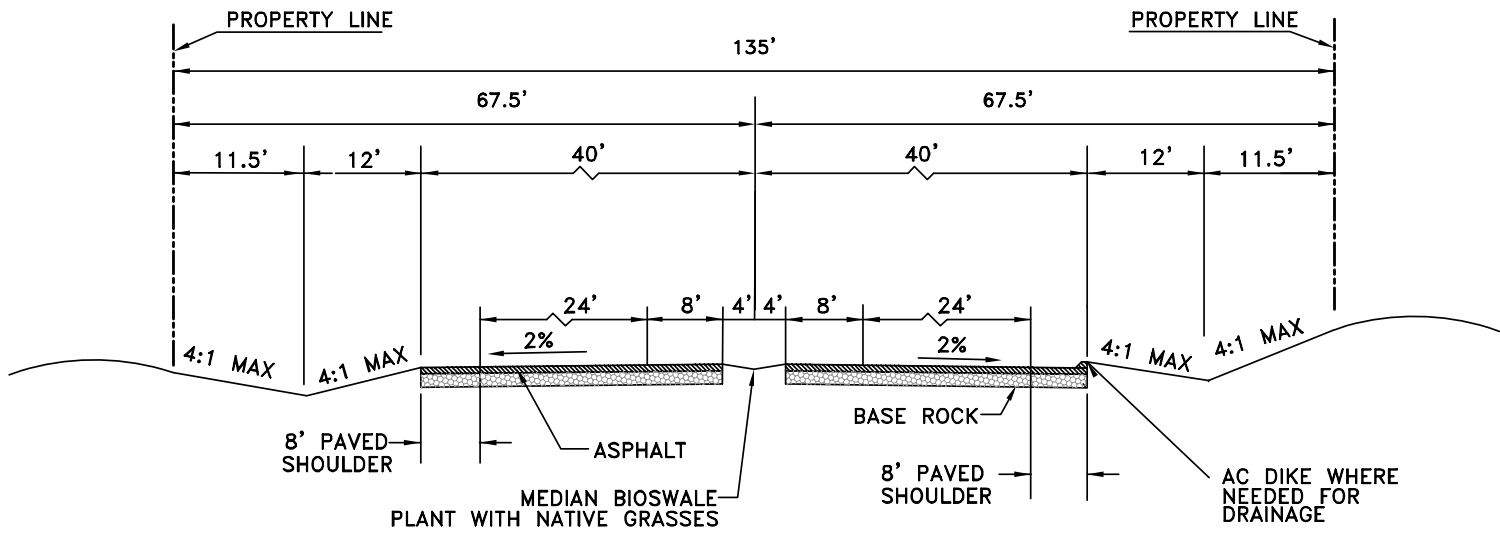


Checked By: DAVID LEAMON, RCE	By	Revised
Updated By: PAUL SAINI, RCE DONAL HICKS, SR. ENGR. TECH		

135 FT OPT  
4 LANE RURAL EXPRESSWAY  
COUNTY OF STANISLAUS  
DEPARTMENT OF PUBLIC WORKS

APPROVED BY: *Matthew Machado*  
MATTHEW MACHADO  
DIRECTOR OF PUBLIC WORKS  
DATE: JUNE 2, 2014  
PLATE NO.: 3-A16

### 135 FT OTHER PRINCIPAL ARTERIAL (4 LANE RURAL EXPRESSWAY)



NOT TO SCALE

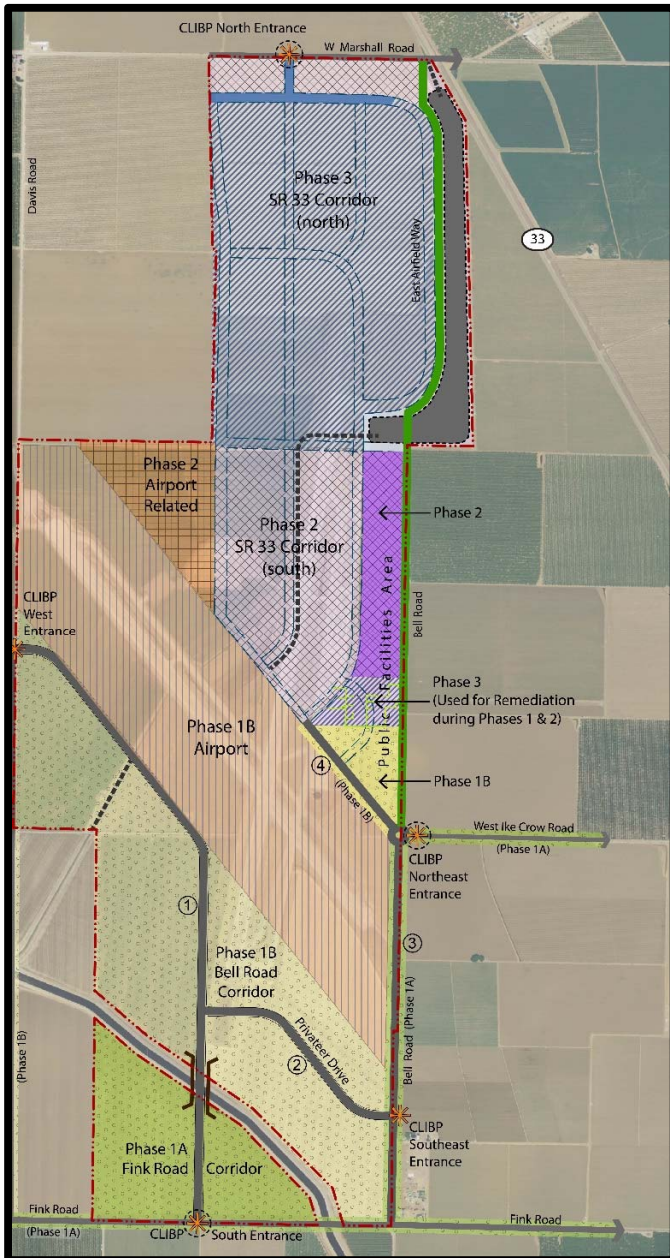
**NOTE:**

1. PROVIDE MINIMUM 8 FT PAVED SHOULDER.
2. PAVEMENT CROSS SLOPE SHALL BE 2.0% MINIMUM ON NEW ROAD CONSTRUCTION.
3. ADDITIONAL SLOPE EASEMENTS MAY BE REQUIRED FOR ADEQUATE GRADING AND/OR DRAINAGE.
4. INSTALL AC DIKE WHERE REQUIRED FOR DRAINAGE, SEE CROSS SECTION ABOVE.
5. DIVIDE TRAVEL LANES WITH UNPAVED MEDIAN AS SHOWN.
6. UNDERGROUND FRENCH DRAIN MAYBE REQUIRED IN THE SWALE AREA TO HELP CONTROL DRAINAGE AND ENHANCE SAFETY.

# Transportation Infrastructure Plan

## Crows Landing Industrial Business Park

August 24, 2018



Pleasanton  
Fresno  
Sacramento  
Santa Rosa



## **Transportation Infrastructure Plan For Crows Landing Industrial Business Park**

August 24, 2018

Prepared by:  
TJKM Transportation Consultants  
4305 Hacienda Drive  
Suite 550  
Pleasanton, CA 94588-2798  
Tel: 925.463.0611  
Fax: 925.463.3690

## Table of Contents

<b>Introduction.....</b>	<b>1</b>
The Project.....	1
Purpose of this Report.....	1
Future Analyses .....	1
Executive Summary.....	4
<b>Analysis Methodology.....</b>	<b>6</b>
Study Intersections .....	6
Study Roadway Segments.....	7
Analysis Scenarios .....	8
Level of Service Analysis Methodology and Thresholds .....	8
Caltrans Facilities .....	10
<b>Existing Conditions .....</b>	<b>11</b>
Roadway Network.....	11
Existing Peak Hour and Daily Traffic.....	13
Level of Service Analysis - Existing Conditions.....	13
<b>Project Description.....</b>	<b>16</b>
Project Location .....	16
Site Layout .....	16
Regional Significance of Project .....	16
Trip Generation.....	16
Travel Demand Model .....	20
Description of Daily Study Model .....	20
South County Corridor.....	21
Existing plus Project Conditions.....	21
<b>Near Term Improvements Triggered by CLIBP Project .....</b>	<b>25</b>
Improvement Categories .....	25
Phasing of Improvements .....	25
On-site Backbone Street Requirements.....	25
Off-site Two Lane Streets – No Widening Required .....	26
Off-site Two Lane Roadways Needing Widening to Four Lanes .....	26
Off-site Traffic Signals Needed .....	27
Fink Road Interchange Improvements .....	27
City of Patterson Impacts.....	28
<b>2035 Conditions .....</b>	<b>31</b>
Modeling Network.....	31
Proposed Project Description .....	31
Analysis Results .....	31
<b>Additional Segment Analysis .....</b>	<b>36</b>
<b>2035 Triggers.....</b>	<b>37</b>
2035 No Project.....	37
2035 Plus CLIBP .....	37
Comments on 2035 and 2035 plus Project Widening.....	38
<b>Fair Share Analysis .....</b>	<b>38</b>
City of Patterson Cumulative Impacts .....	39
Transportation Demand Management.....	40

## List of Figures

Figure 1: Regional Vicinity Map.....	2
Figure 2: Local Vicinity Map.....	3
Figure 3: CLIBP Proposed Site Plan.....	19
Figure 4: Backbone Roads Identification .....	29
Figure 5: Improvement Needs.....	30

## List of Tables

Table I: Level of Service for Signalized Intersections .....	9
Table II: Generalized Annual Average Daily Volumes LOS Thresholds .....	10
Table III: Intersection Levels of Service – Existing Conditions .....	14
Table IV: Roadway/Freeway Segment Levels of Service – Existing Conditions.....	15
Table V: Proposed Crows Landing Industrial Business Park Land Use and Trip Generation Estimates.....	17
Table VI: Intersection Levels of Service - Existing plus Project Conditions .....	23
Table VII: Roadway Segment Level of Service - Existing plus Project Conditions .....	24
Table VIII: Intersection Levels of Service - 2035 Baseline Conditions.....	32
Table IX: Roadway Segment Level of Service - 2035 Baseline Conditions.....	33
Table X: Intersection Levels of Service - 2035 plus Project Conditions.....	34
Table XI: Roadway Segment Level of Service - 2035 plus Project Conditions.....	35
Table XII: Fair Share Analysis - Intersections .....	39
Table XIII: Fair Share Analysis - Segments.....	39

## Introduction

This report provides an analysis of transportation infrastructure needs related to the development of the proposed Crows Landing Industrial Business Park (CLIBP). This development is located south of the City of Patterson and is generally bounded by Marshall Road on the north, State Route (SR) 33 and Bell Road on the east, Fink Road on the south and Davis Road on the west. Figure 1 shows the regional location of CLIBP while Figure 2 provides a local context.

### The Project

CLIBP is proposed to be a regional employment center occupying the land previously used as the Crows Landing Naval Air Station. It contains two runways, one of which will be retained for the industrial park. The site has 1,274 developable acres that are currently planned to contain over 14 million square feet of governmental, logistical/ distribution, aviation, industrial and business park uses. CLIBP is intended to be developed in phases over a number of years.

### Purpose of this Report

The purpose of this report is to determine the preliminary transportation infrastructure improvements that are required to accommodate the proposed development. The infrastructure needs include the following categories:

- On-site backbone street requirements
- Off-site two lane streets requiring reconstruction, but not widening
- Off-site two lane streets requiring widening to four lanes
- Off-site traffic signals needed
- Fink Road interchange improvements needed

Identification of transportation infrastructure needs is important in order to determine the order of magnitude of costs associated with the development of the site by the County of Stanislaus.

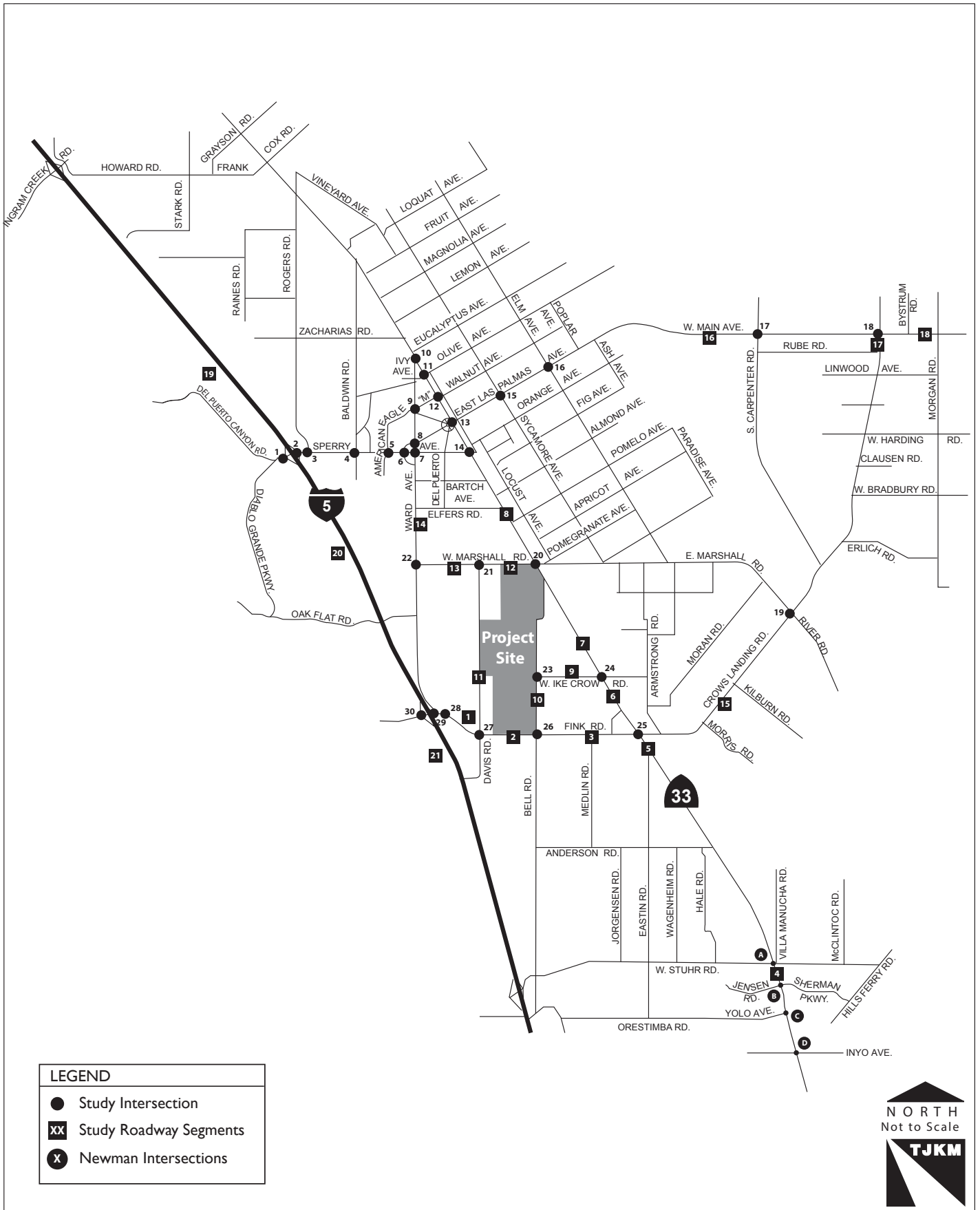
TJKM conducted the required study for this report by measuring existing traffic, determining the vehicular trip generation associated with the site, and combining the site traffic with both existing conditions and with 2035 conditions, based on the use of the Stanislaus Council of Governments (StanCOG) Tri-County Traffic Forecasting Model. The project itself is intended to be developed over three 10-year increments, so the 2035 conditions that assume full project buildout, represent a conservative analysis.

### Future Analyses

Stanislaus County will be preparing an Environmental Impact Report (EIR) to provide a comprehensive analysis of the proposed CLIBP. As a part of the EIR, a transportation analysis will be prepared. The report contained in this document and the future EIR transportation analysis are companion studies; the EIR analysis will be based on the same basic data considered in this report.







## **Executive Summary**

This Transportation Infrastructure Master Plan for CLIBP describes the results of a traffic analysis conducted by TJKM Transportation Consultants. CLIBP is a proposed 1,528 acre, mixed-use industrial development located at the former site of the Crows Landing Naval Air Station just south of the City of Patterson.

Impact Analysis This report examines traffic impacts under existing conditions, existing plus full project conditions, 2035 conditions and 2035 plus full project conditions. TJKM examined existing conditions at 30 study intersections and 21 roadway segments to determine the transportation improvements that would be required as a result of the proposed CLIBP development. For this analysis, traffic conditions were compared with daily traffic roadway capacity values established for the agencies that have jurisdiction over roadways in the project vicinity – Stanislaus County, the City of Patterson and Caltrans. Stanislaus County’s level of service (LOS) standard is LOS C for intersections and LOS D for road segments while the City of Patterson utilizes LOS D as its standard. Caltrans utilizes a LOS standard at the C/D transition.

Existing Conditions This study examines the existing roadway network near CLIBP. Nearly all roadways in the area are two-lane roadways serving agricultural activities and the incorporated areas. TJKM found that all 30 study intersections currently operate at acceptable conditions; of the 19 study intersections that are not signalized none currently meet signal warrants. The 18 roadway segments evaluated all currently have two lanes and none of the sections requires four lanes. The three freeway segments on I-5 are four lanes each, and additional lanes are not needed.

Project Traffic TJKM determined that the proposed project will likely contain over 14 million square feet of development and employ up to 14,447 persons at full buildout. The daily trip generation for the project will be 52,422 trips while the a.m. and p.m. peak hour generation will be 5,653 trips and 6,344 trips, respectively. Because of the large size and likely area of impact of the project, TJKM utilized the Tri-County model to evaluate traffic conditions. The traffic models for StanCOG, the San Joaquin Councils of Government (SjCOG) and the Merced County Association of Governments (MCAG) were recently combined to create this model. The model was utilized to evaluate Existing Plus project, 2035 no project, and 2035 Plus Project conditions.

It is TJKM’s judgment that the existing plus project scenario is the most appropriate tool to evaluate the transportation improvements triggered by the CLIBP project. Although the project is likely to be built over many years and other, non-project, development and its traffic will come on line during this same time period, TJKM utilized near-term conditions to determine project responsibilities. A comprehensive EIR is being prepared for this project, and this traffic study forms the basis for the EIR transportation analysis. Fair-share responsibilities of all improvements will be presented as part of the EIR analysis. This study thereby focuses on the “up-front” requirements of the project and those additional needs during the life of the project. The following needed improvements have been identified:

On-site backbone street requirements – Nearly all on-site streets, including the backbone streets required during the first phase of the development, are recommended for a three- lane cross section.

Off-site two-lane roadways not requiring widening but needing to be rebuilt or resurfaced – Roadways in this category are portions of Bell Road, Davis Road, Ike Crow Road, Fink Road and Marshall Road.

Off-site roadways requiring four lanes – Portions of Marshall Road adjacent to the project, SR 33 from Patterson to Marshall Road, and a section of Crows Landing Road crossing the San Joaquin River will eventually need to be widened to four lanes. The four-lane river crossing on Crows Landing Road is not likely to be needed for many years – the County is currently considering rebuilding the existing two-lane bridge to bring it to current design and structural standards. The four-lane bridge is likely to be required near the end of the 30-year project development phase.

Off-site signals needed – TJKM has identified 11 intersections in the vicinity of the project that will eventually need to be signalized.

Fink Road interchange improvements needed – Although the Fink Road/I-5 interchange is basically a low-capacity rural interchange, it will not be an attractive route for employee travel to CLIBP. Employee traffic will make up the majority of trips generated by the project. Fink Road will, however, be an important link for truck and other business-travel to and from the project. Some widening under the freeway, off-ramp widening, and ramp traffic signals will need to be phased improvements for the interchange.

2035 Analysis TJKM determined additional intersection and roadway improvements that will be required by a combination of regional growth and the development of CLIBP. Additional traffic signals will be required, and more roadway sections will eventually need to be widened to four lanes. An analysis of impacts within the City of Newman reflects recent General Plan and other studies conducted in the City. It is recommended that a traffic impact fee be calculated to determine the fair share of required improvements so that the County can be reimbursed for other projects that have been “fronted” by CLIBP.

The Sperry Road interchange already requires improvement, and it is assumed that others will provide for its improvement. The City of Patterson, Stanislaus County, StanCOG and others have assigned this interchange improvement as a high priority for construction, possibly on a phased basis.

Project linkages to Stanislaus Regional Transit and other transit providers are recommended to serve the project. Also, as a part of the environmental review of the project, when specific transportation demand management (TDM) measures are identified, it will be possible to reduce the actual expected vehicular trips on certain roadway segments to reflect the programs and measures. Ridesharing and employee transit usage offer the greatest potential for trip reduction.

## Analysis Methodology

### Study Intersections

The County of Stanislaus staff has identified a list of 30 study intersections that will be included in the level of service (LOS) analysis. These intersections are under the jurisdiction of the City of Patterson, the County of Stanislaus or Caltrans. The list of intersections and applicable jurisdictions are as shown below and included in Figure 2:

1. I-5 SB Ramps / Sperry Avenue (Caltrans)
2. I-5 NB Ramps / Sperry Avenue (Caltrans)
3. Rogers Road / Sperry Avenue (City of Patterson)
4. Baldwin Road / Sperry Avenue (City of Patterson)
5. American Eagle Way / Sperry Avenue (City of Patterson)
6. Las Palmas Avenue / Sperry Avenue (City of Patterson)
7. Ward Avenue / Sperry Avenue (City of Patterson)
8. Ward Avenue / Las Palmas Avenue (City of Patterson)
9. Ward Avenue / M Street (City of Patterson)
10. Ward Avenue / SR 33 (Caltrans)
11. Olive Avenue / SR 33 (Caltrans)
12. Walnut Avenue / SR 33 (Caltrans)
13. Las Palmas Avenue / SR 33 (Caltrans)
14. Sperry Avenue / SR 33 (Caltrans)
15. Sycamore Avenue / Las Palmas Avenue (Stanislaus County)
16. Elm Avenue / Las Palmas Avenue (Stanislaus County)
17. Carpenter Road / W. Main Street (Stanislaus County)
18. Crows Landing Road / W. Main Street (Stanislaus County)
19. Crows Landing Road / Marshall Road (Stanislaus County)
20. Marshall Road / SR 33 (Caltrans)
21. Marshall Road / Davis Road (Stanislaus County)
22. Marshall Road / Ward Ave (Stanislaus County)
23. Ike Crow Road / Bell Road (Stanislaus County)
24. Ike Crow Road / SR 33 (Caltrans)
25. Fink Road / SR 33 (Caltrans)
26. Fink Road / Bell Road (Stanislaus County)
27. Fink Road / Davis Road (Stanislaus County)
28. Fink Road / Ward Avenue (Stanislaus County)
29. I-5 NB Ramps / Fink Road (Caltrans)
30. I-5 SB Ramps / Fink Road (Caltrans)

TJKM also evaluated four intersections in and near the City of Newman

- A. Stuhr Road / SR 33
- B. Jensen Road / SR 33
- C. Yolo Avenue / SR 33
- D. Inyo Avenue / SR 33

The intersection LOS analysis results for all the intersections are included in this report, while the mitigation measures also will be a part of the EIR transportation analysis as provided in this report. Peak hour signal warrant analyses were conducted for all the unsignalized study intersections and the results are included in this report.

In addition, the Fink Road interchange intersections with I-5 also were analyzed in this report.

### **Study Roadway Segments**

Potential impacts from the proposed development for local roadway segments and freeway segments in the project vicinity are also evaluated. The selected study roadway segments are shown below and also included in Figure 2.

#### Roadway Segments

1. Fink Road between Ward Avenue and Davis Road (Stanislaus County)
2. Fink Road between Davis Road and Bell Road (Stanislaus County)
3. Fink Road between Bell Road and SR-33 (Stanislaus County)
4. SR-33 south of Stuhr Road north of Newman (Caltrans)
5. SR-33 between Stuhr Road and Fink Road (Caltrans)
6. SR-33 between Fink Road and Ike Crow Road (Caltrans)
7. SR-33 between Ike Crow Road and Marshall Road (Caltrans)
8. SR-33 between Marshall Road and Sperry Avenue (Caltrans)
9. Ike Crow Road between SR-33 and Bell Road (Stanislaus County)
10. Bell Road between Fink Road and Ike Crow Road (Stanislaus County)
11. Davis Road south of Marshall Road (Stanislaus County)
12. Marshall Road between SR-33 and Davis Road (Stanislaus County)
13. Marshall Road between Davis Road and Ward Avenue (Stanislaus County)
14. Ward Avenue between Marshall Road and Patterson (Stanislaus County)
15. Crows Landing Road between SR 33 and Marshall Road (Stanislaus County)
16. W. Main Street / Las Palmas Avenue west of Carpenter Road (Stanislaus County)
17. Crows Landing Road between Carpenter Road and W. Main Street (Stanislaus County)
18. W. Main Street east of Crows Landing Road (Stanislaus County)

#### Freeway Segments

1. I-5 north of Sperry Avenue (Caltrans)
2. I-5 between Sperry Avenue and Fink Road (Caltrans)
3. I-5 south of Fink Road (Caltrans)

### **Analysis Scenarios**

The following traffic analysis scenarios were addressed in this study:

1. *Existing Conditions* – This scenario evaluates existing (2014) traffic volumes and roadway conditions based on existing counts.
2. *Existing plus CLIBP Buildout Conditions* – This scenario adds traffic generated by the proposed CLIBP to the previous scenario.
3. *2035 No CLIBP Project Conditions* – A Crows Landing Project-Specific Model was developed based on the latest Tri-County Travel Demand model and City of Patterson Travel Demand Model. This scenario assumes vacant land at the Crows Landing Project area.
4. *2035 plus CLIBP Build Out Conditions* – This scenario adds traffic generated by the proposed Project to the previous scenario.

### **Level of Service Analysis Methodology and Thresholds**

Level of service (LOS) is a qualitative description of intersection operations using an A through F letter rating system to describe travel delay and congestion. LOS A indicates free flow conditions with little or no delay, and LOS F indicates jammed conditions with excessive delays and long back-ups.

This report analyzes 16 intersections within the City of Patterson and 14 intersections in unincorporated areas. Twelve of the unincorporated intersections are in the general vicinity of the project site; the remaining two intersections are on W. Main Street. Although all 21 roadway segments are outside of Patterson, comments are made on impacts for existing two lane streets in the City. The City has already identified which two-lane streets will eventually need to be widened to four lanes, to resolve level of service issues. In the County, project and other growth traffic will determine which County roads will need widening in the future.

Intersections: Operating conditions at the study intersections were evaluated using the 2000 Highway Capacity Manual (HCM 2000) Operations methodology. Peak hour traffic operational conditions for signalized intersections are reported as average control delay for the overall intersection in seconds per vehicle with corresponding LOS. Table I shows the control delay ranges for each level of service category. These are also the LOS ranges utilized by the City of Patterson.

The County of Stanislaus threshold of significance for intersections is LOS C, indicating LOS D or worse conditions are unacceptable. The City of Patterson utilizes LOS D as its standard of significance for intersections, indicating LOS E or F conditions are unacceptable. In this report intersections within the City of Patterson are evaluated with the LOS D standard; all other intersections are evaluated with the LOS C standard.

Roadway segments: For county roadway segments and conventional state highways, TJKM utilized the LOS thresholds contained in Table 3-12, “Roadway Segment Level of Service Criteria,” contained in the County’s *Standards and Specifications, 2014 Edition.* For Patterson city streets, TJKM used LOS tables developed by the Florida Department of Transportation for signalized

roadways. For freeway segments, TJKM used Florida standards as well. The Florida LOS tables are recognized as a standard reference source for using daily traffic volumes as an indicator of roadway adequacy. The standards for various roadway sections are shown in Table II.

The minimum acceptable level of service standard for Stanislaus County and Patterson roadway segments is LOS D. Therefore, this report uses LOS D as the minimum acceptable standard to determine the number of lanes required along City, County and State roadways within the study area.

**Table I: Level of Service for Signalized Intersections**

Level of Service	Description
A	Very low control delay, up to 10 seconds per vehicle. Progression is extremely favorable, and most vehicles arrive during the green phase. Many vehicles do not stop at all. Short cycle lengths may tend to contribute to low delay values.
B	Control delay greater than 10 and up to 20 seconds per vehicle. There is good progression or short cycle lengths or both. More vehicles stop causing higher levels of delay.
C	Control delay greater than 20 and up to 35 seconds per vehicle. Higher delays are caused by fair progression or longer cycle lengths or both. Individual cycle failures may begin to appear. Cycle failure occurs when a given green phase does not serve queued vehicles, and overflow occurs. The number of vehicles stopping is significant, though many still pass through the intersection without stopping.
D	Control delay greater than 35 and up to 55 seconds per vehicle. The influence of congestion becomes more noticeable. Longer delays may result from some combination of unfavorable progression, long cycle lengths, or high volumes. Many vehicles stop, the proportion of vehicles not stopping declines. Individual cycle failures are noticeable.
E	Control delay greater than 55 and up to 80 seconds per vehicle. The limit of acceptable delay. High delays usually indicate poor progression, long cycle lengths, and high volumes. Individual cycle failures are frequent.
F	Control delay in excess of 80 seconds per vehicle. Unacceptable to most drivers. Oversaturation, arrival flow rates exceed the capacity of the intersection. Many individual cycle failures. Poor progression and long cycle lengths may also be contributing factors to higher delay.

Source: Highway Capacity Manual 2000

**Table II: Generalized Annual Average Daily Volumes LOS Thresholds**

Facility Type	No. of Lanes	Median	Level of Service (LOS)			
			B	C	D	E
City Streets	2	Undivided	-	14,400	16,040	-
	4	Divided	-	30,600	32,000	-
	6	Divided	-	46,900	48,150	-
County and State Roads	2	Undivided	-	11,800	20,000	-
	4	Divided	-	28,440	40,000	-
	6	Divided	-	56,700	67,500	-
Freeways	4		44,100	57,600	68,900	71,700
	6		65,100	85,600	102,200	111,000
	8		85,100	113,700	135,200	150,000

Source: 2012 Florida DOT Quality/Level of Service Handbook, Table 2, Florida DOT  
Stanislaus County Department of Public Works, 2014 Standards and Specifications

### **Caltrans Facilities**

Facilities under the jurisdiction of Caltrans include freeway segments, ramps, ramp terminals, and state routes. Caltrans standards strive to maintain acceptable traffic operations on state facilities between LOS C and LOS D. This report uses LOS D as the minimum acceptable standard to determine the number of lanes required along freeway segments and state highway segments.

Therefore, a Caltrans four-lane freeway has six lanes triggered at 68,900 vehicles per day, a two-lane City street has four lanes triggered at 16,040 vehicles per day, and Stanislaus County roadways and State Highways have four lanes triggered at 20,000 vehicles per day.



## Existing Conditions

### Roadway Network

The project site is located south of the City of Patterson in Stanislaus County, as shown in Figures 1 and 2. Important roadways serving the project site are discussed below.

*Interstate 5 (I-5)* is a major north-south freeway that runs through the western portion of Stanislaus County. It is generally a four-lane freeway with two travel lanes in each direction through the Central Valley of California. The average daily traffic volume on I-5 through Stanislaus Counties is about 40,000 vehicles per day (vpd). I-5 has existing interchanges with Fink Road in the vicinity of the project and with Sperry Avenue in the City of Patterson.

*The interchange of I-5/Sperry Avenue* is a tight diamond interchange with a narrow, local road underpass and a steep drop in grade next to the northbound on-ramp. The ramps are one lane in all directions; the off-ramps are currently controlled by stop signs. The City of Patterson and Stanislaus County have embarked upon a comprehensive study of the interchange, which could result in improvements such as signalizing the ramp intersections at Sperry Avenue and the widening of intersection approaches.

*The interchange of I-5/Fink Road* is a diamond interchange with a narrow local road undercrossing. The Fink Road undercrossing is constrained by columns that support the I-5 Bridge; the off-ramps are currently controlled by stop signs.

*State Route 33 (SR 33)* is a north-south arterial roadway that runs parallel to the Union Pacific Rail Road (UPRR) with an at-grade rail crossing north of the intersection with Ward Avenue. SR 33 is located on the eastern edge of the Project area, approximately three miles to the east of I-5 and provides access to Westley and beyond to the north and the City of Newman and beyond to the south. SR 33 carries approximately 3,550 vpd in the project area and 7,500 vpd in the City of Patterson.

*Sperry Avenue* is a two-lane, east-west arterial roadway that serves as the major route running through the City of Patterson between I-5 to the west and SR 33 to the east, a three-mile distance. The segment of Sperry Road between Baldwin Road and Ward Avenue consists of four lanes. Sperry Avenue carries approximately 12,200 vpd near the I-5 freeway.

*Las Palmas Avenue* is a three-lane, east-west arterial roadway that includes a center two-way left-turn lane. West of SR 33, four streets form a roundabout at Las Palmas Avenue. Traffic destined for Modesto currently uses either Las Palmas Avenue or SR 33. Las Palmas Avenue carries approximately 13,000 vpd. Outside of the Patterson city limits, Las Palmas Avenue is a two-way roadway and becomes W. Main Street east of the San Joaquin River.

*Sycamore Avenue* is a two-lane, north-south collector roadway in the City of Patterson. Sycamore Avenue links Loquat Avenue to the north and East Marshall Road to the south, a distance of seven miles.

*Del Puerto Canyon Road* a two-lane, east-west local roadway in Stanislaus County that connects Santa Clara County in the west with the I-5 southbound ramps, where it continues easterly as Sperry Avenue.

*Rogers Road* is a north-south collector roadway that provides access between SR 33 in the north and Sperry Avenue in the south. From Sperry Avenue to approximately 0.35 miles north, Rogers Road is a five-lane roadway that includes a two-way left-turn lane. Further north, Rogers Road reduces to two lanes.

*Baldwin Road* is a two-lane, north-south collector roadway that provides access from Vineyard Avenue in the north to just south of Azalea Drive in the south, where it terminates.

*American Eagle Avenue* is a two-lane, north-south collector roadway that runs between Sweet Briar Drive in the south to Ward Avenue in the north, where it continues northeasterly as M Street.

*Ward Avenue* is a two-lane, north-south collector roadway that runs between Fink Road outside of the Patterson city limits in the south and SR 33 in the north.

*M Street* is a two-lane, east-west local roadway that links Ward Avenue in the west and SR 33 in the east, where it continues easterly as Walnut Avenue.

*Olive and Walnut Avenues* are two-lane, east-west roadways that link SR 33 in the west with Poplar Avenue in the east. Olive Avenue continues as Ivy Avenue west of SR 33, and terminates just past Poplar Avenue in the east. Walnut Avenue continues as M Street west of SR 33 and terminates at Poplar Avenue in the east.

*Elm Avenue* is a two-lane, north-south local roadway that runs between Marshall Avenue in the south to just north of Loquat Avenue, where it terminates.

*Carpenter Road* is a two-lane, north-south collector roadway that links the City of Modesto in the north with Crows Landing Road in the south.

*Fink Road* is a two-lane east-west arterial roadway that links I-5 in the west with the unincorporated community of Crows Landing in the east. East of SR 33, Fink Road becomes Crows Landing Road, which continues northerly to the City of Modesto.

*Marshall Road* is a two-lane east-west collector roadway that runs along the project site's northern boundary, and links Ward Avenue in the west with Crows Landing Road in the east within unincorporated Stanislaus County. East of Crows Landing Road, Marshall Road becomes River Road and continues southerly to its terminus at Hills Ferry Road northeast of the City of Newman.

*Davis Road* is a two-lane north-south collector roadway that runs along the project site's western boundary, and provides access between Marshall Road in the north and Fink Road in the south. Davis Road continues 0.75 miles south of Fink Road before turning west to cross I-5 and terminating at an adjacent rural/residential development.

*Ike Crow Road* is a two-lane, east-west collector roadway that links the project site with SR 33 and Armstrong Road to the east within unincorporated Stanislaus County.

*Bell Road* is a two-lane, north-south collector roadway that runs along the project site's eastern boundary, and links SR 33 in the north with Orestimba Road in the south within unincorporated Stanislaus County.

### **Existing Peak Hour and Daily Traffic**

TJKM collected existing 24-hour daily tube counts for 18 Stanislaus County study roadway segments in January 2014. These are shown on Table III. In addition, turning movement counts at 30 study intersections were collected during both a.m. peak period (7 a.m. to 9 a.m.) and p.m. peak period (4 p.m. to 6 p.m.) in January 2014. Volumes on I-5 were obtained from Caltrans documents.

### **Level of Service Analysis - Existing Conditions**

Table III summarizes the results of the intersection level of service analysis for Existing Conditions. Currently, all existing study intersections and study roadway segments operate at acceptable levels of service based on applicable jurisdictional standards.

Table III also summarizes whether the peak hour warrant is met for all the unsignalized study intersections during both a.m. and p.m. peak hours. As shown, no unsignalized study intersections meet peak hour signal warrants under existing conditions.

**Table III: Intersection Levels of Service – Existing Conditions**

ID	Intersection	Type of Control	A.M. Peak Hour			P.M. Peak Hour		
			Delay	LOS	Meet Signal Warrant	Delay	LOS	Meet Signal Warrant
1	I-5 SB Ramps / Sperry Ave	OWSC	11.6	B	N	22.2	C	N
2	I-5 NB Ramps / Sperry Ave	OWSC	9.8	A	N	13.4	B	N
3	Rogers Rd / Sperry Ave	Signalized	13.5	B	-	13.7	B	-
4	Baldwin Rd / Sperry Ave	Signalized	18.5	B	-	16.0	B	-
5	American Eagle Way / Sperry Ave	Signalized	16.5	B	-	13.1	B	-
6	Las Palmas Ave / Sperry Ave	Signalized	13.8	B	-	16.2	B	-
7	Ward Ave / Sperry Ave	Signalized	33.4	C	-	21.6	C	-
8	Ward Ave / Las Palmas Ave	Signalized	13.2	B	-	9.8	A	-
9	Ward Ave / M St	Signalized	42.4	D	-	26.1	C	-
10	Ward Ave / SR 33	OWSC	13.3	B	N	13.9	B	N
11	Olive Ave / SR 33	TWSC	14.2	B	N	14.6	B	N
12	Walnut Ave / SR 33	Signalized	24.4	C	-	18.7	B	-
13	Las Palmas Ave / SR 33	Signalized	16.5	B	-	15.6	B	-
14	Sperry Ave / SR 33	TWSC	23.3	C	N	37.2	E	N
15	Sycamore Ave / Las Palmas Ave	Signalized	18.0	B	-	14.5	B	-
16	Elm Ave / Las Palmas Ave	Signalized	10.5	B	-	10.6	B	-
17	Carpenter Rd / W. Main St	AWSC	11.0	B	N	12.2	B	N
18	Crows Landing Rd. / W. Main St	AWSC	14.5	B	N	16.0	C	N
19	*Crows Landing Rd / Marshall Rd	AWSC	8.9	A	N	10.1	B	N
20	Marshall Rd / SR 33	TWSC	11.4	B	N	11.3	B	N
21	Marshall Rd / Davis Rd	OWSC	8.6	A	N	8.8	A	N
22	Marshall Rd / Ward Ave	OWSC	8.7	A	N	8.8	A	N
23	Ike Crow Rd / Bell Rd	TWSC	8.8	A	N	0.0	A	N
24	Ike Crow Rd / SR 33	TWSC	10.3	B	N	10.9	B	N
25	Fink Rd / SR 33	AWSC	11.5	B	N	9.7	A	N
26	Fink Rd / Bell Rd	TWSC	10.1	B	N	9.5	A	N
27	Fink Rd / Davis Rd	TWSC	9.8	A	N	9.7	A	N
28	Fink Rd / Ward Ave	OWSC	9.4	A	N	9.2	A	N
29	I-5 NB Ramps / Fink Rd	OWSC	8.8	A	N	8.8	A	N
30	I-5 SB Ramps / Fink Rd	OWSC	9.4	A	N	9.6	A	N

Notes: OWSC = One Way Stop Control, TWSC = Two Way Stop Control, AWSC = All Way Stop Control, LOS = Level of Service

**Bold** values indicate unacceptable LOS conditions and signal warrant met

\*Intersection 19 is currently TWSC but has been approved and is analyzed as AWSC

Source: TJKM Transportation Consultants, January 2015

Table IV summarizes the results of the roadway segment/freeway segment level of service analysis for Existing Conditions. Currently, all existing study roadway segments operate at acceptable levels of service. No additional lanes are required to meet the LOS threshold.

**Table IV: Roadway/Freeway Segment Levels of Service – Existing Conditions**

ID	Roadway Segments	Existing Number of Lanes	Jurisdiction	LOS Threshold	Existing Conditions		
					ADT	LOS	# of Lanes Required
1	Fink Rd between Ward Ave and Davis Rd	2	County	D	1,638	C or Better	2
2	Fink Rd between Davis Rd and Bell Rd	2	County	D	1,490	C or Better	2
3	Fink Rd between Bell Rd and SR-33	2	County	D	1,661	C or Better	2
4	SR-33 south of Stuhr Rd north of Newman	2	Caltrans	C-D	8,197	C or Better	2
5	SR-33 between Stuhr Rd and Fink Rd	2	Caltrans	C-D	5,123	C or Better	2
6	SR-33 between Fink Rd and Ike Crow Rd	2	Caltrans	C-D	3,619	C or Better	2
7	SR-33 between Ike Crow Rd and Marshall Rd	2	Caltrans	C-D	3,545	C or Better	2
8	SR-33 between Marshall Rd and Sperry Ave	2	Caltrans	C-D	4,161	C or Better	2
9	Ike Crow Rd between SR-33 and Bell Rd	2	County	D	27	C or Better	2
10	Bell Rd between Fink Rd and Ike Crow Rd	2	County	D	50	C or Better	2
11	Davis Rd south of Marshall Rd	2	County	D	77	C or Better	2
12	Marshall Rd between SR-33 and Davis Rd	2	County	D	656	C or Better	2
13	Marshall Rd between Davis Rd and Ward Ave	2	County	D	641	C or Better	2
14	Ward Ave between Marshall Rd and Patterson City Limits	2	County	D	1,246	C or Better	2
15	Crows Landing Rd between Fink Rd and Marshall Rd	2	County	D	2,396	C or Better	2
16	W. Main St west of Carpenter Rd	2	County	D	7,342	C or Better	2
17	Crows Landing Rd between Carpenter Rd and W. Main St	2	County	D	5,237	C or Better	2
18	W. Main St east of Crows Landing Rd	2	County	D	6,392	C or Better	2
	<b>Freeway Segments</b>						
19	I-5 n/o Sperry Ave	4	Caltrans	C-D	40,000	B or Better	4
20	I-5 between Fink Rd and Sperry Ave	4	Caltrans	C-D	38,000	B or Better	4
21	I-5 s/o Fink Rd	4	Caltrans	C-D	37,000	B or Better	4

Notes: LOS = Level of Service, n/o = north of, s/o = south of  
Source: TJKM Transportation Consultants, January 2015

## Project Description

### Project Location

The proposed CLIBP Project will be located entirely on the former 1,528-acre Crows Landing Naval Air Station located north of Fink Road, east of Davis Road, west of SR 33 and Bell Road and south of Marshall Road in an unincorporated area of Stanislaus County, California. The project vicinity is shown in Figures 1 and 2.

### Site Layout

The proposed CLIBP is envisioned to include approximately 14 million square feet of governmental, logistical/distribution, aviation, industrial and business park uses. The CLIBP will be developed in three phases over an approximate 30-year period.

The distribution of land uses includes 370 acres devoted to general aviation uses, 68 acres to various municipal uses, 349 acres for logistics/distribution, 350 acres for industrial uses, 78 acres for business park uses, 46 acres for aviation-related uses, and 13 acres for multi-modal uses. The remaining acreage will be associated with the necessary infrastructure. Figure 3 shows the CLIBP site plan, including phasing.

### Regional Significance of Project

The CLIBP will be located within commute distance of many Central Valley communities. The project will potentially attract employees from the Stanislaus County communities of Patterson, Newman, Modesto, Ceres and Turlock but could draw employees and visitors from nearby Merced and San Joaquin counties. Most of the employee trips are drawn either from Patterson to the north or from the communities to the east such as Turlock and Modesto. The project area is currently served by state and county highway facilities. A few area roadways are expected to be widened to accommodate future project-related traffic.

### Trip Generation

Table V shows trip generation estimates for the proposed CLIBP Project. Trip generation for the Project was estimated based on rates provided in *Trip Generation* (9th Edition) published by the Institute of Transportation Engineers (ITE).

In traffic studies for proposed development projects, a specific project proposal is evaluated in which building square footage is known. In such cases, it is generally considered that the traffic generating characteristics of the building square footage, using ITE rates, is more reliable than using employment data, which is more speculative. The available factors in this case are planned land use designations, floor area ratios, and employee densities. Based on this information, the number of employees for each land use category for each development phase was calculated. The corresponding ITE trip generation rates for each category were utilized to produce the total Project trip generation on a daily and peak hour basis.

The proposed Project is expected to produce up to 14,447 employees that will generate a total of approximately 52,422 daily trips, 5,653 a.m. peak hour trips and 6,344 p.m. peak hour trips.

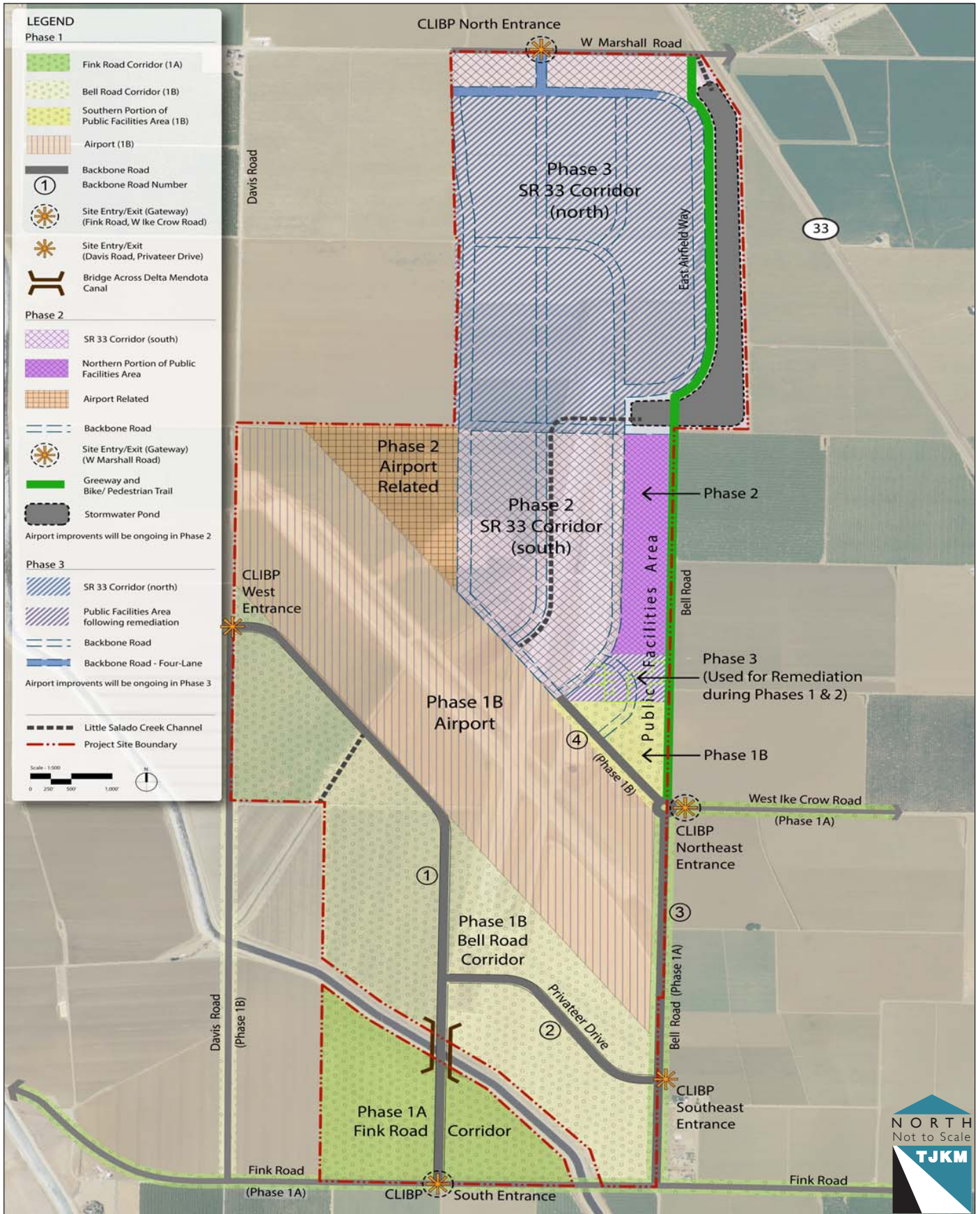
**Table V: Proposed Crows Landing Industrial Business Park Land Use and Trip Generation Estimates**

Proposed Land Use						Trip Generation Estimate														
Corridor/Use (Developable Land)	Developable Acres	Floor- Area Ratio (FAR)	Building Area, (per KSF)	Employees (per KSF)	Total Employees	ITE Land Use Code	Daily		AM Peak Hour						PM Peak Hour					
							Rate / Equation	Total Trips	Rate / Equation	Total Trips	In %	Out %	In	Out	Rate / Equation	Total Trips	In %	Out %	In	Out
<b>PHASE I (764 Acres)</b>																				
<b>PHASE IA: Fink Rd Corridor</b>																				
Logistics/Distribution	52	0.35	785	0.35	275	High-Cube Warehouse/Distribution Center (152) *	Equ. E	1,168	KSF-based Trip Rates AM PH/Daily Ratio	77	69%	31%	53	24	KSF-based Trip Rates PM PH/Daily Ratio	84.127	31%	69%	26	58
Industrial	41	0.35	628	0.97	609	General Light Industrial (110)	Equ. B	1,827	Equ. C	235	83%	17%	195	40	Equ. D	235	21%	79%	49	185
Business Park	10	0.35	157	2.80	440	Business Park (770)	Equ. F	2,332	Equ. G	246	85%	15%	209	37	Equ. H	238	22%	78%	52	185
<i>Phase IA: Fink Rd Corridor Subtotal</i>	<b>103</b>		<b>1,570</b>		<b>1,324</b>			<b>5,328</b>		<b>558</b>			<b>457</b>	<b>101</b>		<b>556</b>			<b>128</b>	<b>429</b>
<b>PHASE IB: Bell Rd Corridor</b>																				
Logistics/Distribution	138	0.35	2,104	0.35	736	High-Cube Warehouse/Distribution Center (152) *	Equ. E	2,568	KSF-based Trip Rates AM PH/Daily Ratio	169.5052	69%	31%	117	53	KSF-based Trip Rates PM PH/Daily Ratio	184.915	31%	69%	57	128
Industrial	110	0.35	1,683	0.97	1,633	General Light Industrial (110)	Equ. B	4,848	Equ. C	511	83%	17%	424	87	Equ. D	532	21%	79%	112	420
Business Park	28	0.35	421	2.80	1,178	Business Park (770)	Equ. F	4,687	Equ. G	573	85%	15%	487	86	Equ. H	527	22%	78%	116	411
<i>Bell Rd Corridor Subtotal</i>	<b>276</b>		<b>4,208</b>		<b>3,547</b>			<b>12,103</b>		<b>1,254</b>			<b>1,029</b>	<b>225</b>		<b>1,244</b>			<b>285</b>	<b>959</b>
<b>Aviation - Phases I through 3 (Part of Phase I Infrastructure)</b>	370	NA	NA	NA	1	General Aviation Airport (022)**	Equ. A	116	1.29	1	50%	50%	1	1	Equ. L	3	55%	45%	2	1
<b>Public Facilities - Law Enforcement, Fire, Municipal Offices, etc.</b>	15	0.25	163	2.80	457	General Office Building (710)	Equ. I	1,595	Equ. J	246	88%	12%	217	30	Equ. K	229	17%	83%	39	190
<i>Phase IB Subtotal</i>	<b>661</b>		<b>4,371</b>		<b>4,005</b>			<b>13,814</b>		<b>1,502</b>			<b>1,246</b>	<b>256</b>		<b>1,476</b>			<b>326</b>	<b>1,150</b>
<b>PHASE I TOTAL</b>	<b>764</b>		<b>5,941</b>		<b>5,329</b>			<b>19,142</b>		<b>2,060</b>			<b>1,703</b>	<b>356</b>		<b>2,032</b>			<b>453</b>	<b>1,579</b>
<b>PHASE 2 (236 Acres)</b>																				
<b>SR 33 Corridor (South)</b>																				
Logistics/Distribution	57	0.40	990	0.69	683	High-Cube Warehouse/Distribution Center (152) *	Equ. E	2,419	KSF-based Trip Rates AM PH/Daily Ratio	160	69%	31%	110	49	KSF-based Trip Rates PM PH/Daily Ratio	174	31%	69%	54	120
Industrial	71	0.40	1,237	0.97	1,200	General Light Industrial (110)	Equ. B	3,571	Equ. C	394	83%	17%	327	67	Equ. D	406	21%	79%	85	321
Business Park	14	0.40	247	2.80	693	Business Park (770)	Equ. F	3,140	Equ. G	363	85%	15%	309	54	Equ. H	343	22%	78%	75	268
<i>SR 33 Corridor (South) Subtotal</i>	<b>142</b>		<b>2,474</b>		<b>2,576</b>			<b>9,129</b>		<b>917</b>			<b>746</b>	<b>171</b>		<b>1,721</b>			<b>215</b>	<b>709</b>
<b>Aviation-Related Use</b>	<b>46</b>	0.40	<b>802</b>	0.35	<b>281</b>	General Aviation Airport (022)**	Equ. A	<b>3,837</b>	1.29	<b>362</b>	50%	50%	<b>181</b>	<b>181</b>	Equ. L	355	55%	45%	<b>195</b>	<b>160</b>

Proposed Land Use						Trip Generation Estimate															
Multimodal Transportation (Bike/Ped Trail + Monument)	13	NA	NA	NA	2																
Public Facilities - Law Enforcement, Fire, Municipal Offices, etc.	35	0.25	381	2.80	1,067	General Office Building (710)	Equ. I	3,252	Equ. J	511	88%	12%	450	61	Equ. K	455	17%	83%	77	378	
<b>PHASE 2 TOTAL</b>	<b>236</b>		<b>3,657</b>		<b>3,926</b>			<b>16,219</b>		<b>1,791</b>			<b>1,377</b>	<b>414</b>		<b>2,531</b>			<b>487</b>	<b>1,246</b>	
<b>PHASE 3 (274 Acres)</b>																					
<b>SR 33 Corridor (North)</b>																					
Logistics/Distribution	102	0.40	1,784	0.69	1,231	High-Cube Warehouse/Distribution Center (152) *	Equ. E	3,876	KSF-based Trip Rates AM PH/Daily Ratio	256	69%	31%	176	79	KSF-based Trip Rates PM PH/Daily Ratio	279	31%	69%	87	193	
Industrial	128	0.40	2,230	0.97	2,163	General Light Industrial (110)	Equ. B	6,411	Equ. C	654	83%	17%	543	111	Equ. D	685	21%	79%	144	541	
Business Park	26	0.40	446	2.80	1,249	Business Park (770)	Equ. F	4,913	Equ. G	603	85%	15%	513	90	Equ. H	553	22%	78%	122	431	
<i>SR 33 Corridor (North) Subtotal</i>	<b>256</b>		<b>4,460</b>		<b>4,643</b>			<b>15,200</b>		<b>1,513</b>			<b>1,232</b>	<b>281</b>		<b>1,517</b>			<b>352</b>	<b>1,165</b>	
Public Facilities - Law Enforcement, Fire, Municipal Offices, etc.	18	0.25	196	2.80	549	General Office Building (710)	Equ. I	1,861	Equ. J	289	1	0	254	35	Equ. K	263	0	1	45	218	
<b>PHASE 3 TOTAL</b>	<b>274</b>		<b>4,656</b>		<b>5,192</b>			<b>17,061</b>		<b>1,802</b>			<b>1,486</b>	<b>316</b>		<b>1,781</b>			<b>397</b>	<b>1,384</b>	
<b>GRAND TOTAL</b>	<b>1,274</b>		<b>14,254</b>		<b>14,447</b>			<b>52,422</b>		<b>5,653</b>			<b>4,567</b>	<b>1,086</b>		<b>6,344</b>			<b>1,337</b>	<b>4,209</b>	

Notes: \* Employee-Based Rates missing : Daily rates base on Industrial Park (130), AM/PM Peak Hour based on KSF-based rates Peak to Daily Ratio  
 \*\* Peak Hour Trip Rates for Aviation are for peak hour of the generator  
 Equ. = Equation from ITE Trip Generation. T=Total Trips, X=Total Employees  
 Equ. A:  $T=13.29*X+102.99$ ; Equ. B:  $T=2.95*X+30.57$ ; Equ. C:  $T=0.27*X+70.47$ ; Equ. D:  $T=0.29*X+58.03$ ; Equ. E:  $\ln(T)=0.8*\ln(X)+2.57$ ; Equ. G:  $\ln(T)=0.86*\ln(X)+0.27$ ; Equ. H:  $\ln(T)=0.81*\ln(X)+0.54$ ; Equ. I:  $\ln(T)=0.84*\ln(X)+2.23$ ; Equ. J:  $\ln(T)=0.86*\ln(X)+0.24$   
 Equ. K:  $T=0.37(X)+60.08$ ; Equ. L:  $\ln(T)=0.85*\ln(X)+1.08$   
 AM Peak to Daily Ratio = 0.066, PM Peak to Daily Ratio = 0.072  
 Source: Mead & Hunt, Inc., July 2014 (Land Use); TJKM Transportation Consultants, July 2014 (Trip Generation); ITE Trip Generation 9<sup>th</sup> Edition, 2012





---

## **Travel Demand Model**

### ***Description of Daily Study Model***

A long-range traffic-forecasting model was used to assess the impact of the proposed Crows Landing Industrial Business Park. The StanCOG (Stanislaus County Council of Governments) countywide gravity based model was used in the study.

TJKM used the most current StanCOG model for the study. The StanCOG model is used for the Stanislaus County Regional Transportation Plan (RTP) and other purposes. The current model, known as the Three-County Model, combines the StanCOG model with those used in San Joaquin County (SJCOG model) and Merced County (MCAG model). The combined model provides very good coverage of the study area, extending from Tracy-Stockton to the north of and Los Banos to the south of the Project area.

All of the modeling done recently in Stanislaus County has been based on the then-most recent version of the StanCOG model. This includes the Patterson General Plan, the current CLIBP study, the South County Corridor Study, the Sperry Road interchange analysis, and the current Crows Landing Road study.

A detailed model calibration was made based on the counts collected at the study intersections and study roadway segments. Detailed Traffic Analysis Zones (TAZs) are used to represent geographical locations in the model. Trips are generated at the TAZ level and distributed onto the roadway network. TJKM developed three new traffic analysis zones (TAZs) for the project area and loaded the ITE trip generation volumes into the model for distribution and assignment.

Model calibration is a process to adjust the model estimates to the existing traffic condition as reflected in the traffic counts. Demand forecasting models need to be demonstrably reliable and credible after the model calibration before being used for analysis on a project. It is important that the analysis tools not become a point of contention, so that the real issues can be properly understood and addressed both within the design team and public meetings. The calibration effort of the Patterson model was pursued with this goal in mind. Since the  $R^2$  (which is a measure of the accuracy of the traffic estimates) is nearly 0.9 after model calibration (verses 0.5 or less before calibration), it can be concluded that TJKM has calibrated the model to a very high level of accuracy.

After the model was calibrated, the difference method <sup>1</sup>(Wu & Thnay, ITE 2001) was used to obtain future link level and intersection turning movement volumes based on the calibrated OD matrices. These volumes were used to calculate the level of service for the study intersections in this project.

In this study, TJKM used the model to determine a.m. and p.m. peak hours and daily trips. TJKM used the model to develop forecasts for Existing Plus Project, 2035 No Project and 2035 Plus project conditions.

**Appendix A** contains plots showing project traffic assignment to the street network during a.m. and p.m. peak hours.

---

<sup>1</sup> Wu, J.H. and C. Thnay (2001), "An OD Based Method for Estimating Link and Turning Volume Based on Counts", *Proceedings of Institute of Transportation Engineers (ITE) District 6 Annual Conference, July 9-12, 2001*.

### **South County Corridor**

The South County Corridor (SCC) Feasibility Study was a recently completed cooperative planning effort between the Stanislaus Council of Governments (StanCOG), Stanislaus County, and the Cities of Patterson, Turlock and Newman, to assess the feasibility of a new east-west four lane divided expressway that would provide a direct travel route between State Route 99 and Interstate 5 (I-5) in the southern part of Stanislaus County. The study was completed in 2016.

Although there appears to be a consensus that such a roadway should be constructed, there is not yet a single preferred alternative for the SCC. Several alternatives are still being considered. A Project Study Report is the next planned step in the SCC, which will provide more detailed environmental and traffic analyses. This may result in the selection of a preferred alternative.

The City of Patterson General Plan includes a proposed new interchange on I-5 at the Zacharias Road alignment north of the City. This is one version of the western terminus of the SCC. From Zacharias Road, the SCC could follow the W. Main Street corridor to the City of Turlock. Because of its status it was not possible to include the SCC in the CLIBP analysis.

However, the SCC is likely to ultimately provide some traffic relief to Patterson streets, particularly Sperry Road and Las Palmas Avenue. In the description of future traffic impacts in Patterson, with and without the CLIBP, a discussion of potential SCC benefits is included in a qualitative fashion.

#### **Existing plus Project Conditions**

This section analyzes 2014 traffic conditions in the study area with the proposed CLIBP project. TJKM utilized the existing transportation network upon which to assign project trips. Traffic volumes from 2014 were the latest available during the preparation of this report. However, 2015 Caltrans volumes are now available; on I-5 and SR 33 in Patterson, 2015 volumes are unchanged from 2014 volumes. The report volumes are still representative of baseline conditions.

Table VI summarizes the results of the intersection level of service analysis under Existing plus Project conditions. The table shows the delay at each intersection, whether traffic signal warrants are satisfied, and the change in delay resulting from the addition of project traffic.

Table VII summarizes the results of the segment level of service analysis under Existing plus Project conditions. The table shows both existing number of lanes and the expected number of lanes required for acceptable roadway operations under existing conditions with and without the project.



*Fink Road / I-5 Interchange*

**Table VI: Intersection Levels of Service - Existing plus Project Conditions**

ID	Intersection Name	Type of Control	A.M. Peak Hour			P.M. Peak Hour			Delay Diff from Existing Conditions	
			Delay	LOS	Meet Signal Warrant	Delay	LOS	Meet Signal Warrant	A.M. Peak Hour	P.M. Peak Hour
1	I-5 SB Ramps / Sperry	OWSC	67.3	<b>F</b>	N	28.6	D	N	55.7	6.4
2	I-5 NB Ramps / Sperry	OWSC	11.9	B	N	16.2	C	N	2.1	2.8
3	Rogers Rd / Sperry	Signalized	11.6	B	-	11.9	B	-	1.1	0.4
4	Baldwin Rd / Sperry	Signalized	22.9	C	-	19.6	B	-	4.4	3.6
5	American Eagle Way / Sperry Ave	Signalized	18.1	B	-	13.8	B	-	1.6	0.7
6	Las Palmas / Sperry	Signalized	22.1	C	-	18.3	B	-	8.3	2.1
7	Ward Ave / Sperry	Signalized	>150	<b>F</b>	-	99.4	<b>F</b>	-	-	76.9
8	Ward / Las Palmas	Signalized	64.4	<b>E</b>	-	34.9	C	-	31.0	13.8
9	Ward Ave / M St	Signalized	47.5	D	-	8.3	a	-	5.1	-
10	Ward Ave / SR 33	OWSC	18.4	C	N	16.7	C	N	5.1	2.8
11	Olive Ave / SR 33	TWSC	18.8	C	N	16.5	C	N	4.6	1.9
12	Walnut Ave / SR 33	Signalized	34.6	C	-	22.6	C	-	10.2	3.9
13	Las Palmas / SR 33	Signalized	36.8	D	-	22.8	C	-	20.3	7.2
14	Sperry Ave / SR 33	TWSC	>150	<b>F</b>	<b>Y</b>	>150	<b>F</b>	<b>Y</b>	-	-
15	Sycamore / Las Palmas	Signalized	25.2	C	-	24.3	C	-	7.2	9.8
16	Elm Ave / Las Palmas	Signalized	22.4	C	-	19.7	B	-	11.9	9.1
17	Carpenter/ W. Main	AWSC	>150	<b>F</b>	<b>Y</b>	105	<b>F</b>	<b>Y</b>	-	92.8
18	Crows Landing Rd / W. Main St	AWSC	>150	<b>F</b>	<b>Y</b>	>150	<b>F</b>	<b>Y</b>	-	-
19	Crows Landing Rd / Marshall Rd	AWSC	>150	<b>F</b>	<b>Y</b>	>150	<b>F</b>	<b>Y</b>	-	-
20	Marshall Rd / SR 33	TWSC	>150	<b>F</b>	<b>Y</b>	>150	<b>F</b>	<b>Y</b>	-	-
21	Marshall Rd / Davis Rd	OWSC	-	Note: Davis discontinued with project in place						
22	Marshall Rd / Ward	OWSC	>150	<b>F</b>	N	>150	<b>F</b>	<b>Y</b>	-	.150
23	Ike Crow Rd / Bell Rd	TWSC	30.3	D	N	42.3	<b>E</b>	N	21.5	42.3
24	Ike Crow Rd / SR 33	TWSC	>150	<b>F</b>	N	>150	<b>F</b>	<b>Y</b>	-	-
25	Fink Rd / SR 33	AWSC	>150	<b>F</b>	<b>Y</b>	>150	<b>F</b>	<b>Y</b>	-	-
26	Fink Rd / Bell Rd	TWSC	>150	<b>F</b>	<b>Y</b>	>150	<b>F</b>	<b>Y</b>	-	-
27	Fink Rd / Davis Rd	TWSC	40.7	<b>E</b>	N	15.2	C	N	30.9	5.5
28	Fink Rd / Ward Ave	OWSC	>150	<b>F</b>	N	17.7	C	N	-	8.5
29	I-5 NB Ramps / Fink	OWSC	139.3	<b>F</b>	<b>Y</b>	9.5	A	N	130.5	0.7
30	I-5 SB Ramps / Fink Rd	OWSC	14.2	B	N	23.4	C	N	4.8	13.8

Notes: OWSC = One Way Stop Control, TWSC = Two Way Stop Control, AWSC = All Way Stop Control, LOS = Level of Service

**Bold** values indicate unacceptable LOS conditions

**Bold** values indicate unacceptable LOS conditions and signal warrant met

Source: TJKM Transportation Consultants, January 2015

**Table VII: Roadway Segment Level of Service - Existing plus Project Conditions**

ID	Roadway Segment	Existing # of Lanes	Jurisdiction	LOS Threshold	Existing Conditions			Existing plus Project Conditions		
					ADT	LOS	# of Lanes Requir.	ADT	LOS	# of Lanes Requir.
1	Fink Rd between Ward Ave and Davis Rd	2	County	D	1,638	D or Better	2	4,459	D or Better	2
2	Fink Rd between Davis Rd and Bell Rd	2	County	D	1,490	D or Better	2	3,251	D or Better	2
3	Fink Rd between Bell Rd and SR-33	2	County	D	1,661	D or Better	2	10,225	D or Better	2
4	SR-33 south of Stuhr Rd north of Newman	2	Caltrans	C-D	8,197	C or Better	2	15,957	D	2
5	SR-33 between Stuhr Rd and Fink Rd	2	Caltrans	C-D	5,123	C or Better	2	13,954	D	2
6	SR-33 between Fink Rd and Ike Crow Rd	2	Caltrans	C-D	3,619	C or Better	2	10,769	C or Better	2
7	SR-33 between Ike Crow Rd and Marshall	2	Caltrans	C-D	3,545	C or Better	2	14,825	D	2
8	SR-33 between Marshall Rd and Sperry Ave	2	Caltrans	C-D	4,161	C or Better	2	17,705	D	2
9	Ike Crow Rd between SR-33 and Bell Rd	2	County	D	27	D or Better	2	4,171	D or Better	2
10	Bell Rd between Fink Rd and Ike Crow Rd	2	County	D	50	D or Better	2	6,755	D or Better	2
11	Davis Rd south of Marshall Rd	2	County	D	77	D or Better	2	-	-	-
12	Marshall Rd between SR-33 and CLIBP Entrance	2	County	D	656	D Or Better	2	29,721	<b>E</b>	<b>4</b>
13	Marshall Rd between Davis Rd and Ward Ave	2	County	D	641	D or Better	2	2,746	D or Better	2
14	Ward Ave between Marshall Rd and Patterson City Limits	2	County	D	1,246	D or Better	2	3,959	D or Better	2
15	Crows Landing Rd between Fink Rd and Marshall Rd	2	County	D	2,396	D or Better	2	6,704	D or Better	2
16	W. Main St west of Carpenter Rd	2	County	D	7,342	D or Better	2	10,982	D or Better	2
17	Crows Landing Rd between Carpenter Rd and W. Main St	2	County	D	5,237	D or Better	2	11,010	D or Better	2
18	W. Main St east of Crows Landing Rd	2	County	D	6,392	D or Better	2	9,444	D or Better	2
<b>Freeway Segment</b>										
19	I-5 n/o Sperry Ave	4	Caltrans	C-D	40,000	A	4	41,341	C or Better	4
20	I-5 -- Fink to Sperry	4	Caltrans	C-D	38,000	A	4	39,121	C or Better	4
21	I-5 s/o Fink Rd	4	Caltrans	C-D	37,000	A	4	37,878	C or Better	4

Notes: LOS = Level of Service

**Bold** values indicate unacceptable LOS conditions

**Shading** indicates four lanes are triggered. State highway 4 lane trigger is 20,000 ADT, non-state highway is 16,040ADT

Source: TJKM Transportation Consultants, January 2015

---

## Near Term Improvements Triggered by CLIBP Project

### Improvement Categories

This document examines transportation improvement categories as follows:

- On-site backbone street requirements
- Off-site two lane streets with poor structural conditions and no additional lanes needed
- Off-site two lane streets needing widening to four lanes
- Off-site traffic signals needed
- Fink Road interchange improvements

TJKM utilized the County of Stanislaus Public Works Department 2014 Standards and Specifications to determine various road standards.

### Phasing of Improvements

In this document, TJKM recommends roadway improvements to be timed with, or triggered by, one of three project phases described earlier. TJKM has not conducted phase by phase traffic studies, only an analysis of the entire project under near term (existing plus project) or long term (2035 plus project) conditions. In reality, the three project phases are the best estimate of how the project may develop over time based on a variety of considerations. TJKM has estimated which phase each needed roadway project is associated with, but this also is the best estimate possible at this time. In reality, the timing of roadway improvements should be based on monitoring of roadway conditions during the life of the buildout of the project. Since roadway improvements need to be planned, designed and constructed over a long time period, the monitoring will need to look forward from then-existing conditions for an approximate three to five year period to allow for sufficient time to implement needed improvements.

### On-site Backbone Street Requirements

Figure 4 shows the planned layout and phasing of the CLIBP along with the backbone roads. For the purposes of this analysis, all backbone roadway segments have been numbered. TJKM assumes that two-lane backbone streets will utilize a standard recommended by the Stanislaus County Public Works Department. This roadway has a 60-foot curb-to-curb width, which is ideal for two 12-foot through lanes, one 12-foot two-way-left-turn (TWLT) center lane and two additional 12-foot wide lanes for parking. This street has a total right of way width of 120 feet, which includes a 30-foot section on each side of the road for drainage and a six-foot sidewalk.

For streets with greater traffic demands, a four-lane roadway with a median to accommodate left turn lanes is recommended.

Most backbone streets for this project need to be two lanes. At the design stages, some widening near important intersections can be expected. The following cross-sections are recommended for backbone streets:

#### Four-lane Roadway Segment 5

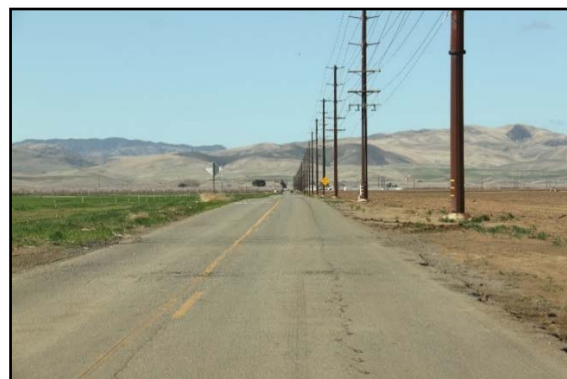
#### Three-lane Roadway

All other backbone streets including segments 1 – 4.

### **Off-site Two Lane Streets – No Widening Required**

There are some streets near the CLIBP that either will not need widening beyond two lanes in the near term, or widening to four lanes, if and when needed, is in the distant future. Some roadways may need minor widening to shoulders or to increase lane widths. The streets listed below are in that category, and have poor surface (likely structural) conditions.

- W. Ike Crow Road – Bell Road to SR 33. The approximate length of this roadway is 6,525 feet. This roadway should likely be improved beginning during Phase IA of CLIBP.
- Davis Road – Fink Road to Backbone Roadway I. The approximate length of this roadway is 8,150 feet. This roadway is associated with Phase IB of CLIBP and crosses the Delta Mendota Canal. The bridge crossing of the canal appears to have adequate width to accommodate the future improvements.
- Bell Road – W. Ike Crow Road to Fink Road. For the purposes of this analysis, this portion of Bell Road is considered segment 3 of the Backbone road system, which is in poor condition. It should likely be improved during Phase IA of CLIBP.
- Marshall Road – Ward Avenue to CLIBP entrance. The approximate length of this roadway is 9,600 feet. (The section from CLIPBP entrance to SR 33 requires four lanes as noted in the next improvement category.) This roadway is characterized by having a series of substantial power poles on the north side of the roadway, which can presumably be considered immovable objects. The poles switch to the south side west of the substation located alongside the east edge of the Delta Mendota Canal. The roadway crossing of the Delta Mendota Canal has a bridge width on Marshall is about 20 to 22 feet, which appears to be marginally acceptable, at least initially. This two-lane improvement should occur in Phases 2 or 3 of CLIBP.
- Fink Road – The County will improve Fink Road between I-5 and Bell Road with an added overlay and striping during Phase IA to ensure a clean functional entrance to the CLIBP.



*Ike Crow Road and Marshall Road near CLIBP*

### **Off-site Two Lane Roadways Needing Widening to Four Lanes**

As noted above, some roadways need widening to four lanes as a result of project-only traffic, some need widening because of regional growth to 2035, while others need widening by a combination of traffic from the project and regional growth. For this purpose, the emphasis is on existing plus project traffic. See Figure 5 for off-site improvement recommendations and phasing.



Marshall Road – CLIBP entrance to SR 33. The approximate length of this roadway is 2,000 feet. Four lanes will be needed by the midpoint of Phase 2 development. This is the only roadway needing widening to four lanes as a result of the CLIBP project.

#### **Off-site Traffic Signals Needed**

The following locations are expected to satisfy peak hour signal warrants. The affected agencies may wish to consider the applicability of roundabouts in lieu of traffic signals when the warrants are met.

14. Sperry Ave at SR 33
17. Carpenter Rd at W. Main St
18. Crows Landing Rd at W. Main St
19. Crows Landing Rd and Marshall Road
20. Marshall Rd at SR 33
22. Marshall Rd at Ward Ave
24. W. Ike Crow Rd at SR 33
25. Fink Rd at SR 33
26. Fink Rd at Bell Rd
29. Fink Rd at I-5 NB ramps
- A. Marshall Rd at North CLIBP entrance
- B. Fink Rd at South CLIBP entrance

Some of these intersections have been included in the City of Patterson General Plan as locations eventually needing traffic signals. These locations satisfy warrants based on existing traffic plus CLIBP traffic. Of these locations, intersections 14, 24, 26 and B are the highest priority, likely needed during the later stages of Phase 1 or the beginning of Phase 2 conditions.

#### **Fink Road Interchange Improvements**

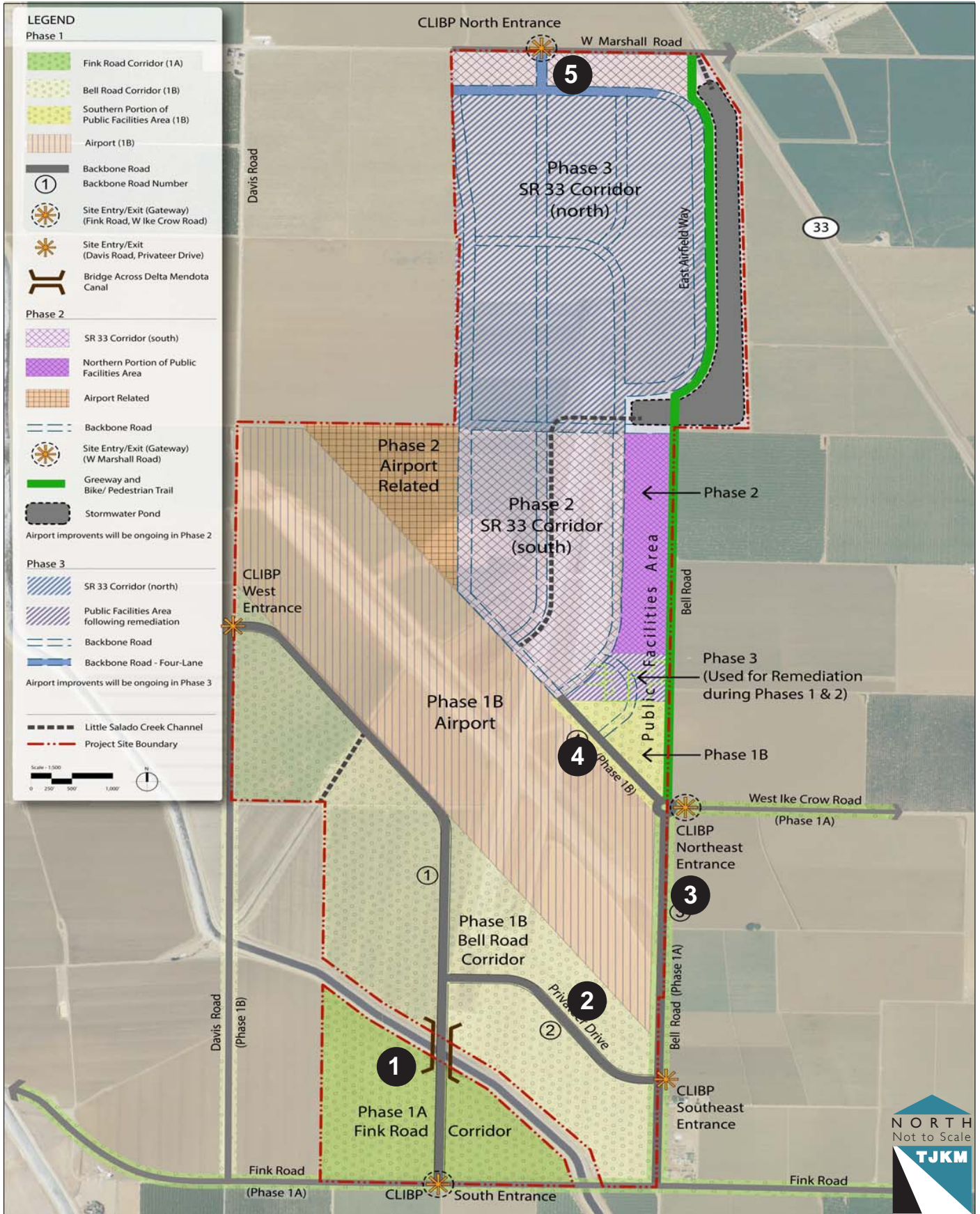
The Fink Road interchange is less likely to be used by CLIBP employee traffic because it does not lead to the major locations where employees are likely to live – Patterson, Newman, Gustine and SR 99 Corridor cities in Stanislaus County. The interchange is likely to be used by trucks from CLIBP. Improvements recommended for the Fink Road interchange include signaling the northbound ramps by Phase 1B conditions along with widening the roadway beneath the freeway as much as possible to create a westbound left turn lane at the southbound ramps intersection. By the completion of the CLIBP, the southbound ramp intersection will also need to be signaled. It is worth noting that there are physical constraints for expanding capacity at this interchange. Widening the Fink Road undercrossing will be difficult due to the location of existing underpass support columns. The situation is compounded by the limited space within the interchange vicinity for possible construction detours. However, no improvements beyond those identified above appear necessary. Figure 5 summarizes the recommended infrastructure phasing in the vicinity of the project.

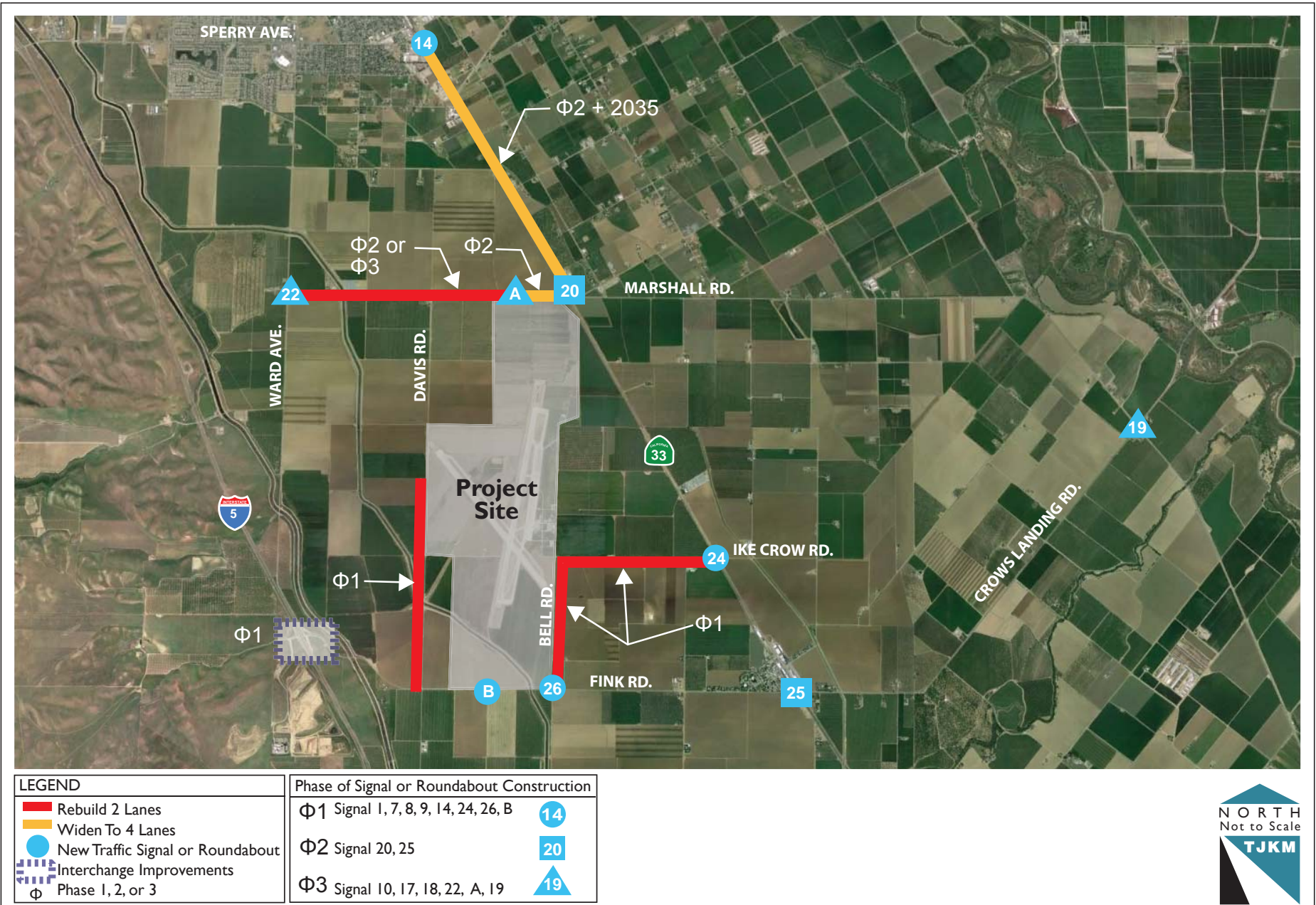
---

### **City of Patterson Impacts**

There are two intersections in the City of Patterson that have unacceptable levels of service under existing plus project conditions.

- I-5 SB Ramps / Sperry Avenue – This intersection is part of interchange improvements now being planned as a joint City/County/State project.
- Ward Avenue / Sperry Avenue – This intersection registers LOS F in the a.m. and p.m. with project traffic added, as was predicted in the Patterson General Plan. This is difficult to improve due to the narrow roadway hemmed in by development on the south leg. Eventually, the construction of the South County Corridor north of Patterson will likely relieve Sperry Avenue of some through traffic. (See the discussion elsewhere on the status of the South County Corridor.)The General Plan calls for additional lanes at the intersection, but these may be difficult to achieve.





## 2035 Conditions

This section analyzes 2035 traffic conditions in the study area both with and without the CLIBP Project.

### Modeling Network

The 2035 network for the Tri-County model reflects all existing and anticipated new roadway segments in San Joaquin, Stanislaus and Merced Counties. The future I-5/Zacharias Road interchange was not assumed for the 2035 networks since CLIBP does not contribute to future traffic at this location.

### Proposed Project Description

The identical project described earlier was included in the 2035 Plus CLIBP scenario. The layout, land use, building square footage and employee estimates are unchanged. The project trip generation is also unchanged.

### Analysis Results

Table VIII shows the results of the intersection level of service analysis for 2035 conditions without the proposed project.



*Crows Landing Road at San Joaquin River*

**Table VIII: Intersection Levels of Service - 2035 without the Project**

ID	Intersection Name	Control	A.M. Peak Hour			P.M. Peak Hour		
			Delay	LOS	Meet Signal Warrant	Delay	LOS	Meet Signal Warrant
1	I-5 SB / Sperry Ave	OWSC	>150	<b>F</b>	<b>Y</b>	>150	<b>F</b>	<b>Y</b>
2	I-5 NB Ramps / Sperry Ave	OWSC	>150	<b>F</b>	<b>Y</b>	>150	<b>F</b>	<b>Y</b>
3	Rogers Rd / Sperry Ave	Signal	26.1	C	-	25.2	C	-
4	Baldwin Rd / Sperry Ave	Signal	25.4	C	-	30.2	C	-
5	American Eagle / Sperry Ave	Signal	19.5	B	-	11.9	B	-
6	Las Palmas Ave / Sperry	Signal	16.8	B	-	18.7	B	-
7	Ward Ave / Sperry Ave	Signal	59.4	<b>E</b>	-	33.3	C	-
8	Ward Ave / Las Palmas	Signal	30.1	C	-	22.9	C	-
9	Ward Ave / M Street	Signal	35.5	-D	-	33.3	C	-
10	Ward Ave / SR 33	OWSC	230	<b>F</b>	<b>Y</b>	107.3	<b>F</b>	<b>Y</b>
11	Olive Ave / SR 33	TWSC	>150	<b>F</b>	<b>Y</b>	>150	<b>F</b>	<b>Y</b>
12	Walnut Ave / SR 33	Signal	37.4	D	-	29.7	C	-
13	Las Palmas Ave / SR 33	Signal	21.0	C	-	21.0	C	-
14	Sperry Ave / SR 33	TWSC	>150	<b>F</b>	<b>Y</b>	>150	<b>F</b>	<b>Y</b>
15	Sycamore / Las Palmas Ave	Signal	37	D	-	20.2	C	-
16	Elm Ave / Las Palmas Ave	Signal	16.3	B	-	15.6	B	-
17	Carpenter Rd / W. Main	AWSC	143.0	<b>F</b>	<b>Y</b>	98.9	<b>F</b>	<b>Y</b>
18	Crows Landing / W. Main St	AWSC	>150	<b>F</b>	<b>Y</b>	>150	<b>F</b>	<b>Y</b>
19	Crows Landing / Marshall Rd	AWSC	>150	<b>F</b>	<b>Y</b>	>150	<b>F</b>	<b>Y</b>
20	Marshall Rd / SR 33	TWSC	>150	<b>F</b>	<b>Y</b>	>150	<b>F</b>	<b>Y</b>
21	Marshall Rd / Davis Rd	OWSC	8.5	A	N	9.8	A	N
22	Marshall Rd / Ward Ave	OWSC	16.1	C	N	12.1	B	N
23	Ike Crow Rd / Bell Rd	TWSC	8.8	A	N	8.9	A	N
24	Ike Crow Rd / SR 33	TWSC	16	C	N	15.4	C	N
25	Fink Rd / SR 33	AWSC	>150	<b>F</b>	<b>Y</b>	118.2	<b>F</b>	<b>Y</b>
26	Fink Rd / Bell Rd	TWSC	13.2	B	N	12.1	B	N
27	Fink Rd / Davis Rd	TWSC	13.9	B	N	12.8	B	N
28	Fink Rd / Ward Ave	OWSC	26.2	D	N	14.7	B	N
29	I-5 NB Ramps / Fink Rd	OWSC	14.2	B	N	12.7	B	N
30	I-5 SB Ramps / Fink Rd	OWSC	14.4	B	N	61	<b>F</b>	N

Notes: OWSC = One Way Stop Control, TWSC = Two Way Stop Control, AWSC = All Way Stop Control, LOS = Level of Service

**Bold** values indicate unacceptable LOS conditions

**Bold and Shaded** values indicate unacceptable LOS conditions and signal warrant met with 2035 conditions

Source: TJKM Transportation Consultants, January 2015.

Table IX summarizes the results of the roadway segment level of service analysis. The table shows both existing number of lanes and the number of lanes required to operate a roadway facility acceptably under 2035 Conditions without the proposed project.

**Table IX: Roadway Segment Level of Service - 2035 without the Project**

ID	Roadway Segment	Existing # of Lanes	Jurisdiction	LOS Threshold	2035 Baseline Conditions		
					ADT	LOS	Lanes required
1	Fink Rd between Ward Ave and Davis Rd	2	County	C	5,767	C or Better	2
2	Fink Rd between Davis Rd and Bell Rd	2	County	C	5,619	C or Better	2
3	Fink Rd between Bell Rd and SR 33	2	County	C	5,764	C or Better	2
4	SR-33 south of Stuhr Rd north of Newman	2	Caltrans	C-D	16,757	D	2
5	SR-33 between Stuhr Rd and Fink Rd	2	Caltrans	C-D	10,296	C or Better	2
6	SR-33 between Fink Rd and Ike Crow Rd	2	Caltrans	C-D	5,588	C or Better	2
7	SR-33 between Ike Crow Rd and Marshall Rd	2	Caltrans	C-D	5,516	C or Better	2
8	SR-33 between Marshall Rd and Sperry Ave	2	Caltrans	C-D	10,297	C or Better	2
9	Ike Crow Rd between SR-33 and Bell Rd	2	County	C	23	C or Better	2
10	Bell Rd between Fink Rd and Ike Crow Rd	2	County	C	44	C or Better	2
11	Davis Rd south of Marshall Rd	2	County	C	74	C or Better	2
12	Marshall Rd between SR-33 and Davis Rd	2	County	C	1,327	C or Better	2
13	Marshall Rd between Davis Rd and Ward Ave	2	County	C	1,309	C or Better	2
14	Ward Ave between Marshall Rd and Patterson City Limits	2	County	C	5,347	C or Better	2
15	Crows Landing Rd between Fink Rd and Marshall Rd	2	County	C	4,334	C or Better	2
16	W. Main St west of Carpenter Rd	2	County	C	21,196	<b>E</b>	4
17	Crows Landing Rd between Carpenter Rd and W. Main St	2	County	C	10,626	C or Better	2
18	W. Main St east of Crows Landing Rd	2	County	C	14,805	<b>E</b>	2
	<b>Freeway Segment</b>						
19	I-5 n/o Sperry Ave	4	Caltrans	C-D	70,368	<b>E</b>	6
20	I-5 between Fink Rd and Sperry Ave	4	Caltrans	C-D	66,883	D	4
21	I-5 s/o Fink Rd	4	Caltrans	C-D	64,328	D	4

Notes: LOS = Level of Service  
**Bold** values indicate unacceptable LOS conditions  
**Shading** indicates widening not required in earlier scenarios. State highway 4-lane trigger is 20,000 ADT, non-state highway is 16,040 ADT. Freeway trigger for six lanes is 68,900 ADT.

Source: TJKM Transportation Consultants, January 2015.

Table X shows the results of the intersection level of service analysis for 2035 conditions with the proposed project. Table XI summarizes the results of the roadway segment level of service analysis.

**Table X: Intersection Levels of Service - 2035 plus Project Conditions**

ID	Intersection	Type of Control	A.M. Peak Hour			P.M. Peak Hour		
			Delay In Sec.	LOS	Meet Signal Warrant?	Delay In Sec.	LOS	Meet Signal Warrant?
1	I-5 SB Ramps / Sperry Ave	OWSC	>150	F	Y	>150	F	Y
2	I-5 NB Ramps / Sperry Ave	OWSC	>150	F	Y	>150	F	Y
3	Rogers Rd / Sperry Ave	Signalized	38.9	D	-	32.3	C	-
4	Baldwin Rd / Sperry Ave	Signalized	45	D	-	53	D	-
5	American Eagle Way / Sperry Ave	Signalized	24	C	-	12	B	-
6	Las Palmas Ave / Sperry Ave	Signalized	29	C	-	21	C	-
7	Ward Ave / Sperry Ave	Signalized	144	F	-	100	F	-
8	Ward Ave / Las Palmas Ave	Signalized	35.1	D	-	31.4	C	-
9	Ward Ave / M St	Signalized	48.0	D	-	38.9	D	-
10	Ward Ave / SR 33	OWSC	>150	F	Y	>150	F	Y
11	Olive Ave / SR 33	TWSC	>150	F	Y	>150	F	Y
12	Walnut Ave / SR 33	Signalized	44.5	D	-	39.5	D	-
13	Las Palmas Ave / SR 33	Signalized	30.6	C	-	24.1	C	-
14	Sperry Ave / SR 33	TWSC	>150	F	Y	>150	F	Y
15	Sycamore Ave / Las Palmas Ave	Signalized	44	D	-	20	C	-
16	Elm Ave / Las Palmas Ave	Signalized	21	C	-	17	B	-
17	Carpenter Rd / W. Main St	AWSC	>150	F	Y	>150	F	Y
18	Crows Landing Rd / W. Main St	AWSC	>150	F	Y	>150	F	Y
19	Crows Landing Rd / River Rd	AWSC	>150	F	Y	>150	F	Y
20	Marshall Rd / SR 33	TWSC	>150	F	Y	>150	F	Y
21	Marshall Rd / Davis Road	OWSC	<i>Note: Davis discontinued with project in place</i>					
22	Marshall Rd / Ward Ave	OWSC	>150	F	Y	>150	F	Y
23	Ike Crow Rd / Bell Rd	TWSC	37	E	N	17	C	N
24	Ike Crow Rd / SR 33	TWSC	>150	F	Y	>150	F	Y
25	Fink Rd / SR 33	AWSC	>150	F	Y	>150	F	Y
26	Fink Rd / Bell Rd	TWSC	>150	F	Y	>150	F	Y
27	Fink Rd / Davis Rd	TWSC	>150	F	Y	45	E	N
28	Fink Rd / Ward Ave	OWSC	>150	F	Y	>150	F	Y
29	I-5 NB Ramps / Fink Rd	OWSC	>150	F	Y	15	C	N
30	I-5 SB Ramps / Fink Rd	OWSC	>150	F	Y	>150	F	N

**Notes:** OWSC = One Way Stop Control, TWSC = Two Way Stop Control, AWSC = All Way Stop Control, LOS = Level of Service

**Bold** values indicate unacceptable LOS conditions

**Shading** indicates signals not warranted under 2035 Baseline scenario

Source: TJKM Transportation Consultants, January 2015.



**Table XI: Roadway Segment Level of Service - 2035 plus Project Conditions**

ID	Roadway Segment	Existing # of Lanes	2035 Baseline Conditions			2035 plus Project Conditions		
			ADT	LOS	# of Lanes Required	ADT	LOS	# of Lanes Required
1	Fink Rd between Ward Ave and Davis Rd	2	5,767	C or Better	2	10,902	C or Better	2
2	Fink Rd between Davis Rd and Bell Rd	2	5,619	C or Better	2	8,032	C or Better	2
3	Fink Rd between Bell Rd and SR 33	2	5,764	C or Better	2	13,709	D	2
4	SR-33 south of Stuhr Rd north of Newman	2	16,757	D	2	23,599	<b>E</b>	<b>4</b>
5	SR-33 between Stuhr Rd and Fink Rd	2	10,296	C or Better	2	18,000	D	2
6	SR-33 between Fink Rd and Ike Crow Rd	2	5,588	C or Better	2	12,183	C or better	2
7	SR-33 between Ike Crow Rd and Marshall Rd	2	5,516	C or Better	2	14,986	D	2
8	SR-33 between Marshall Rd and Sperry Ave	2	10,297	C or Better	2	25,030	<b>F</b>	<b>4</b>
9	Ike Crow Rd between SR-33 and Bell Rd	2	23	C or Better	2	2,865	C or better	2
10	Bell Rd between Fink Rd and Ike Crow Rd	2	44	C or Better	2	6,806	C or better	2
11	Davis Rd south of Marshall Rd	2	74	C or Better	2	-	-	-
12	Marshall Rd between SR-33 and Davis Rd	2	1,327	C or Better	2	32,663	D	2
13	Marshall Rd between Davis Rd and Ward Ave	2	1,309	C or Better	2	5,006	C or better	2
14	Ward Ave between Marshall Rd and Patterson City Limits	2	5,347	C or Better	2	9,103	C or better	2
15	Crows Landing Rd between Fink Rd and Marshall Rd	2	4,334	C or Better	2	9,715	C or better	2
16	W. Main St west of Carpenter Rd	2	21,196	<b>E</b>	<b>4</b>	22,318	<b>E</b>	<b>4</b>
17	Crows Landing Rd between Carpenter Rd and W. Main St	2	10,626	C or Better	2	17,849	D	2
18	W. Main St east of Crows Landing Rd	2	14,805	D	2	17,213	D	2
<b>Freeway Segment</b>								
19	I-5 n/o Sperry Ave	4	70,368	<b>E</b>	<b>6</b>	71,690	<b>E</b>	<b>6</b>
20	I-5 between Fink Rd and Sperry Ave	4	66,883	D	4	69,628	<b>E</b>	<b>6</b>
21	I-5 s/o Fink Rd	4	64,328	D	4	65,338	D	4

**Notes:** Using Florida Capacity Method 2012  
LOS = Level of Service  
**Bold** values indicate unacceptable LOS conditions  
Shading indicates widening not justified under any earlier scenarios. State highway 4-lane trigger is 16,000 ADT, non-state highway is 14,580 ADT. Freeway trigger for 6 lanes is 68,900 ADT.  
Source: TJKM Transportation Consultants, January 2015.

## **Additional Patterson Segment Analysis**

The City of Patterson requested that additional roadway segments in or near the City be evaluated under 2035 conditions. These are described below:

1. Sperry Road between Rogers Road and Ward Avenue: This is planned to be a four lane roadway. This is expected to have a daily count of 19,300 vehicles per day in 2035 with project volumes. The project contributes 24.6 percent of these volumes. With four lanes, this section will operate at LOS C without the project and LOS D with the project.
2. Sperry Road from Ward Avenue to SR 33: As a two-lane roadway the expected 2035 plus project volumes will be 9,015 vehicles per day, of which 38.6 percent are project volumes. This roadway operates at LOS B with and without the project.
3. Ward Avenue from SR 33 to Patterson City Limits: This two-lane roadway is expected to carry 4,145 vehicles per day under 2035 plus project conditions, of which 31.4 percent are contributed by the project. This roadway operates at LOS A with and without the project.
4. SR 33 south of Las Palmas Avenue: This four-lane roadway is expected to have 15,445 vehicles per day in 2035 with project conditions, of which 25.3 percent are contributed by the project. This roadway operates at LOS B without the project and LOS C with the project.
5. SR 33 from Zacharias Road to M Street: This two-lane roadway will carry 7,870 vehicles in 2035 with the project, of which 18.8 percent are contributed by the project. The roadway operates at LOS B with and without the project.

## **Additional Newman Analysis**

The City of Newman called attention to information in the City of Newman General Plan and the Northwest Newman Master Plan and their traffic studies.

Included in the two traffic studies, Table 6 of the General Plan traffic report indicates that within the City SR 33 will average 36,000 vpd at buildout. The General Plan indicates that within the City SR 33 will eventually be widened to four lanes. With 8,200 vpd existing, SR 33 will grow by 27,800 vpd. The Specific Plan study notes that at the busiest location along SR 33, the Specific Plan will contribute approximately 7,700 vehicles per day (vpd). In this case, Specific Plan volumes constitute 28 percent of the growth. It is recognized that a major portion of the growth in trips will be current and future residents of Newman who will be employed within the Specific Plan Area. If the traffic is split 50-50 to account for one trip end in Newman and one trip end in the Specific Plan Area, a reasonable fair share for Newman impacts caused by Specific Plan traffic is approximately 14 percent.

The Newman traffic studies indicate that future traffic signals in the SR 33 corridor in and near Newman will include intersections at Stuhr Road, Jensen Road, Yolo Street, and Inyo Street. Traffic from the Specific Plan will contribute to all four of the new traffic signals. These studies seem reasonable; they are based on generalized information of traffic signals being warranted when total intersection volumes reach 24,000 vpd with at least 3,000 vehicles on one leg of the side street. All four of the signals may not be warranted for many years. However, about 28 percent of the future traffic will be related to Specific Plan buildout. As noted, one half of these trips are generated locally from homes or businesses. For this reason, the Specific Plan's fair share of these impacts is about 14 percent.

Inyo Street is one of the four locations along SR 33 identified as likely to meet traffic signal warrants as a result of growth in traffic. When the General Plan traffic studies were conducted, Inyo Street at SR 33 appeared to be the most congested downtown intersection on SR 33. Therefore, it is likely that it may be the first to meet signal warrants. When these and other SR 33 intersections meet signal warrants, the 14 percent fair share described above would be a reasonable contribution from the Specific Plan.

## **2035 Triggers**

### **2035 No Project**

Tables VIII and IX show the level of service results for 2035 No Project conditions. In this scenario, four additional intersections not previously identified meet traffic signal warrants during one or more of the peak hours. These are:

1. I-5 SB /Sperry Avenue
2. I-5 NB/ Sperry Avenue
10. Ward Avenue/ SR 33
11. Olive Avenue/ SR 33

Two roadway segments require widening for the first time:

16. W. Main Street west of Carpenter Road
19. I-5 north of Sperry Avenue needs widening to six lanes

These are intersections and roadways whose signalization or widening are not triggered by CLIBP.

### **2035 Plus CLIBP**

Tables X and XI show the level of service results for 2035 Plus CLIBP conditions. In this scenario four additional intersections not previously identified meet signal warrants during one or more peak hour periods. These are:

27. Fink Road / Davis Road
28. Fink Road / Ward Avenue
29. I-5 NB Ramps / Fink Road
30. I-5 SB Ramps / Fink Road

Three roadway segments require widening for the first time:

8. SR 33 between Marshall Road and Sperry Avenue
4. SR 33 between Stuhr Road and Fink Road
20. I-5 between Fink Road and Sperry Avenue

### **Comments on 2035 and 2035 plus Project Widening**

E. Las Palmas / W. Main Street – SR 33 to S. Carpenter Road. This western section of this roadway – from SR 33 to Poplar Avenue – is approximately 13,200 feet in length and has three lanes. This three-lane section should be adequate to accommodate CLIBP traffic plus regional growth, particularly since the local agencies are considering the South County Corridor expressway, which may be on a different alignment. The two-lane section of West Main Street between Poplar Avenue and S. Carpenter Road is 17,500 feet long. Again, because of the possibility that the South County Corridor expressway may be on a different alignment, the need for widening is not certain. This section of roadway includes a 750-foot long bridge over the San Joaquin River. (There is a current Stanislaus County project to investigate upgrading this bridge to meet current standards.) TJKM recommends that improvements to this corridor not be included in the initial CLIBP requirements but be handled with a traffic fee arrangement.

SR 33 – From Marshall Road to Sperry Avenue. The approximate length of this roadway is 12,300 feet. In Patterson, the four-lane section of SR 33 has a width of about 60 feet for four-lanes undivided plus parking on one side. The ideal width in this section has four through lanes, about 14 feet for a median or TWLT, and two eight-foot shoulders, or 78 feet of pavement. This corresponds to County standard “110 FT MINOR ARTERIAL 4-LANE RURAL, shown on Plate 3-A15. Widening is needed by the completion of Phase 2 of the development when combined with 2035 growth traffic. During Phases 2 and 3, the State and the County may wish to consider spot improvements consisting of a third center left turn lane at existing public and selected private intersections. Such improvements would enhance both the safety and capacity of SR 33 and delay the need for four lanes.

SR 33 – South of Stuhr Road north of Newman. This section of roadway will exceed two-lane capacity by the end of Phase 3 when combined with 2035 growth traffic. SR 33 through Newman is projected in its General Plan to have an ultimate width of four lanes south of Stuhr Road in and north of the existing city limits. Note the earlier section of this report (*Additional Newman Analysis*) for additional details.

### **Fair Share Analysis**

Tables XII and XIII list all of the projects for which CLIBP has at least partial responsibility. The project share is calculated based on each project's share of the total growth in traffic defined as 2035 plus project less existing conditions. In this case, TJKM utilized the summation of all intersection approach volumes, a.m. plus p.m., in existing, 2035 no project, and 2035 plus project scenarios to determine the components of the calculation.

The same approach is used for segment analyses – in which daily segment volumes are determined for existing, 2035 no project, and 2035 plus project conditions at a point in a roadway segment. This is the methodology recommended by Caltrans.

**Table XII: Fair Share Analysis - Intersections**

No.	Intersection Improvements	Existing (A)	2035 + P (B)	Project (C)	Project Share = (C) / (B-A)	LOS Before	LOS After
14	Sperry Avenue / SR 33	1667	4553	1513	52%	F	A - C
17	Carpenter Road / Main Street	1490	3696	810	37%	F	"
18	Crows Landing Rd / Main Ave	1829	5793	1142	29%	F	"
22	Marshall Road / Ward Ave	239	4743	3354	74%	F	"
20	Marshall Road / SR 33	758	8417	6015	79%	F	"
-	Marshall Road/ Project Entrance				100%	F	"
24	Ike Crow Road / SR 33	630	3840	2409	75%	F	"
26	Fink Road / Bell Road	267	3333	2461	80%	F	"
-	Fink Road / Project Entrance				100%	F	"
19	Crows Landing Rd / Marshall Rd	1131	9211	3838	48%	F	"
25	Fink Road / SR 33	1126	6284	2935	57%	F	"
29	I-5 NB Ramps / Fink Road	262	2549	1075	47%	F	"
1	I-5 SB Ramps / Del Puerto Cyn. Rd	842	3736	479	17%	F	"
2	I-5 NB Ramps / Sperry Ave	1412	4926	707	20%	F	"
10	Ward Avenue / SR 33	1155	3060	363	19%	F	"
11	Olive Avenue / SR 33	1101	2860	322	18%	F	"
27	Fink Road / Davis Road	263	2154	1290	68%	F	"
28	Fink Road / Ward Avenue	310	3247	1693	58%	F	"
30	I-5 SB Ramps / Fink Road	181	1292	548	49%	F	"

**Table XIII: Fair Share Analysis - Segments**

No.	Roadway Improvements (lanes)	Existing (A)	2035 + P (B)	Project (C)	D = (C) / (B-A)	LOS Before	LOS After
12	Marshall Rd - SR 33 to Entrance (4)	656	32,663	31,336	98%	E	D
9	Ike Crow Rd - SR 33 to Bell Rd (2)	27	2,865	2,842	100%	B	B
10	Bell Rd - Ike Crow to Fink Rd (2)	50	6,806	6,762	100%	B	B
13	Marshall Rd - Ward to Entrance (2)	641	5,006	3,697	85%	B	B
8	SR 33 - Marshal Rd to Sperry (4)	4,161	25,030	14,733	71%	F	D
4*	SR 33 - Stuhr Road to Newman (4)	8,200	36,000	7,700	28%	F	E
16	W. Main - West of Carpenter (4)	7,342	22,318	1,122	7%	E	B
F1	I-5 - North of Sperry Road (6)	40,000	71,690	1,322	4%	E	B
F2	I-5 - Fink Rd to Sperry Ave (6)	38,000	69,628	2,745	9%	E	B

\* See *Additional Newman Analysis* for more details.

### **City of Patterson Cumulative Impacts**

Under cumulative conditions, there are five signalized intersections in Patterson that will have unacceptable levels of service without project traffic and one additional signalized intersection in which the combination of project traffic and cumulative traffic causes the intersection to operate under unacceptable conditions. The intersections with unacceptable conditions without the project are as follows:

- Ward Avenue / Sperry Avenue – This intersection was cited as a problem under near term plus project conditions. However, even without CLIBP, this intersection fails. The development of the South County Corridor, an expressway linking SR 99 and I-5 immediately north of Patterson, should reduce traffic pressures in most of the problem intersections. See the discussion on the status of the South County Corridor.

No Patterson intersections degrade to unacceptable conditions when CLIBP traffic is added to cumulative traffic.

### **Transportation Demand Management**

Transportation Demand Management (TDM) is a general term referring to strategies that result in more efficient use of transportation resources. The overall goal of TDM is to influence traveler behavior in order to reduce or redistribute travel demand. Strategies can be developed based on such overall TDM objectives as congestion reduction; energy conservation and emission reduction; health and fitness; improving equity; community livability; parking solutions; safety; and transportation affordability.

TJKM recommends that prior to the occupancy of the first building within the Crows Landing Industrial Business Park a TDM program shall be prepared which includes the following elements:

1. Establishment of a comprehensive strategy to reduce solo occupant vehicle travel by employees, business vehicles including trucks, and visitors.
2. The County shall establish TDM goals for CLIBP which include the reduction of daily travel and the reduction of daily travel within a.m. and p.m. peak periods.
3. The TDMP shall establish a TDM organization that requires mandatory involvement by all companies within the CLIBP. There shall be person(s) assigned representing CLIBP on an ongoing basis to coordinate with individual businesses.
4. Each individual business shall establish a designated TDM company representative.
5. The CLIBP TDM organization shall include mandatory annual employee surveys with a required response of at least 90 percent of the employees. The surveys will include as a minimum mode and time of travel by employees.
6. The CLIBP TDM organization shall prepare an annual report indicating status of compliance with the TDM goals established by the County.
7. The individual companies and the CLIBP TDM organization shall consider the following items to achieve compliance with the TDM goals:
  - a. Encourage employers to utilize flex-time
  - b. Carpool matching programs
  - c. Preferred parking for carpoolers
  - d. Van pool programs
  - e. On-site facilities such as break rooms and shower facilities
  - f. Establishment of employer sponsored shuttles from Turlock and Modesto

- 
- g. On-site secure bicycle racks
  - h. Bike share programs for employee usage at lunchtime
  - i. Other measures

CLIBP includes a bicycle and pedestrian trail that extends between Fink Road and Marshall Road. This facility is intended to be an auxiliary transportation facility rather than a recreational facility. The County and the City of Patterson should make efforts to extend the facility to Patterson to facilitate commute options.

---

## **Study Participants**

### **TJKM Transportation Consultants**

Chris D. Kinzel, P.E.

Project Director

Arthur Chen

Transportation Engineer

Prashanth Dullu

Transportation Engineer

Dan Harrison

Graphics Specialist



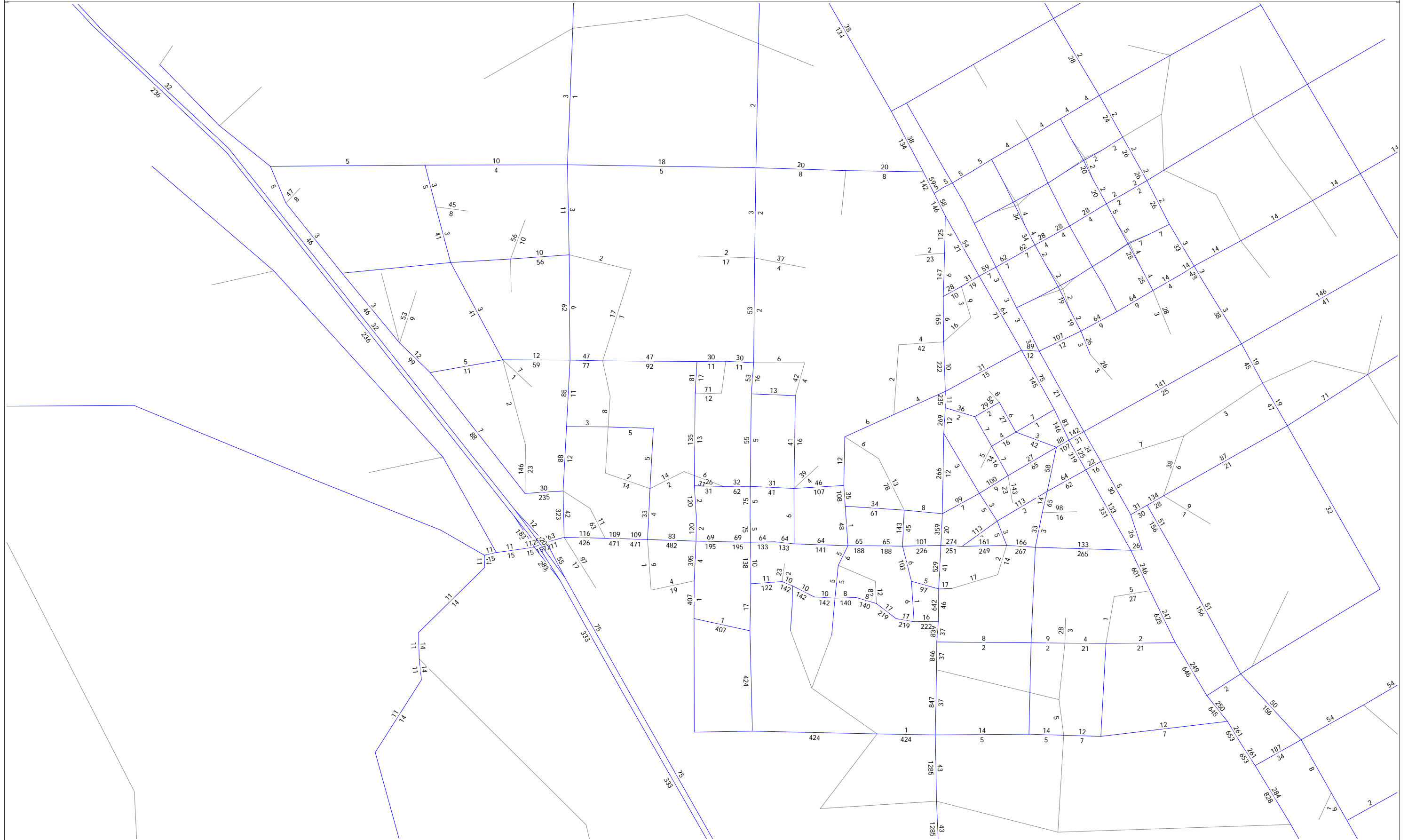
---

---

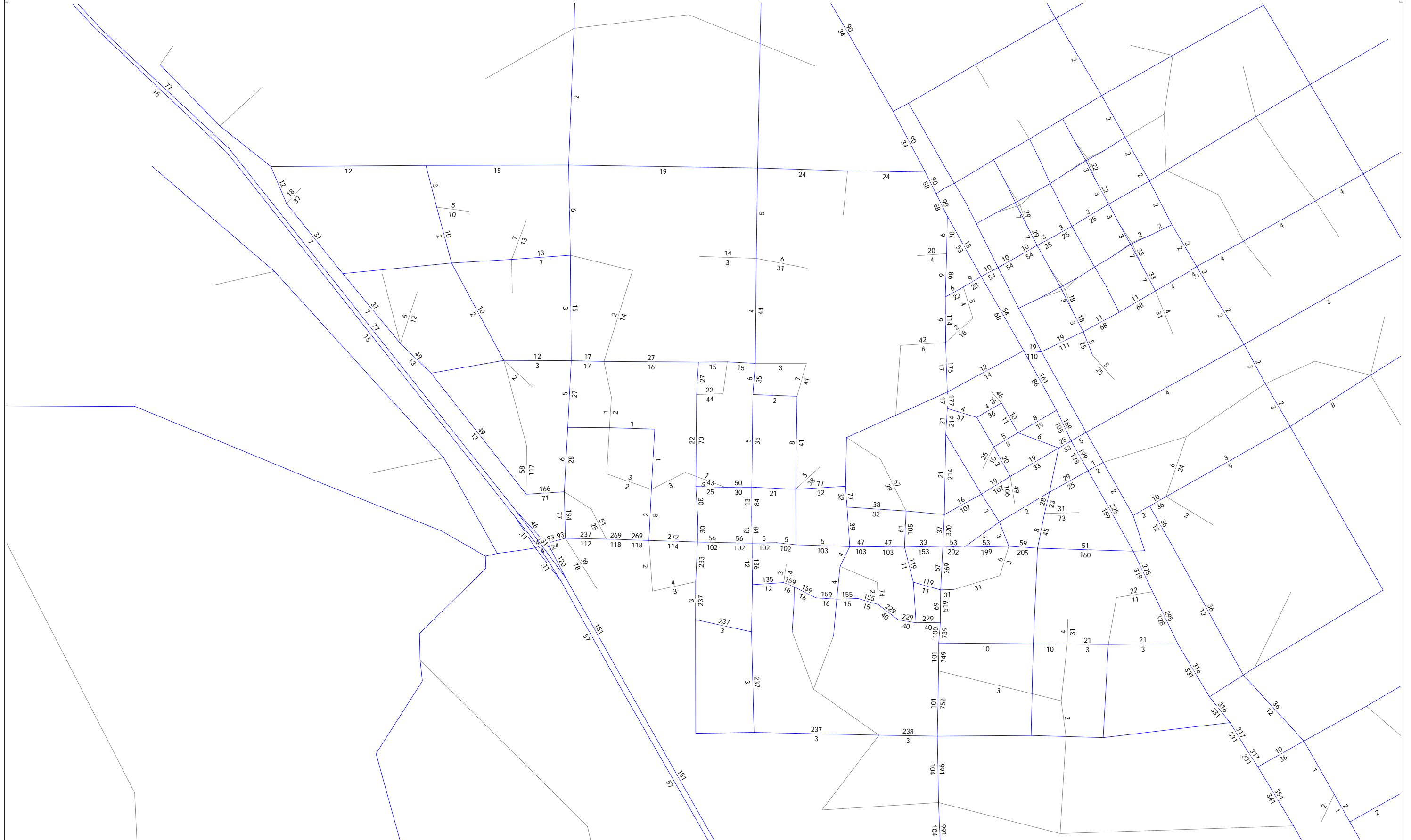
## **Appendix A**

### **A.M. and P.M. Plots of Project Traffic**

Crows Landing 2035 Model  
AM PH Select Zone Volume



Crows Landing 2035 Model  
PM PH Select Zone Volume



**CROWS LANDING INDUSTRIAL BUSINESS PARK**

**WATER SUPPLY (POTABLE & NON-POTABLE)  
INFRASTRUCTURE AND FACILITIES STUDY**

Updated November January 11, 2018 by

AECOM Technical Services, Inc.  
2020 L Street, Suite 400  
Sacramento, CA 95811  
(916) 414-5800

**AECOM**



Prepared for:  
Stanislaus County  
1010 10<sup>th</sup> Street  
Modesto, CA 95354  
(209) 525-4130

Prepared by:  
VVH Consulting Engineers  
126 Drake Avenue  
Modesto, CA 95350  
(209) 568-4477

February 27, 2015

**CROWS LANDING INDUSTRIAL BUSINESS PARK  
WATER SUPPLY (POTABLE & NON-POTABLE) INFRASTRUCTURE AND FACILITIES STUDY  
FEBRUARY 27, 2015 (UPDATED JANUARY 11, 2018)**

**Table of Contents**

**1.0 Introduction .....3**

1.1 Study Background ..... 3

1.2 Study Purpose ..... 3

1.3 Overall System Planning Assumptions..... 4

**2.0 Background investigation .....5**

2.1 Topography ..... 5

2.2 Existing Conditions at Crows Landing Air Facility ..... 5

2.3 Existing Water Sources and Facilities..... 5

    2.3.1 Surface Water Background ..... 5

    2.3.2 Groundwater Background ..... 9

**3.0 Water Supply Alternatives .....16**

3.1 Surface Water ..... 16

    3.1.1 Surface Water Entitlements ..... 16

3.2 Groundwater Supply ..... 16

    3.2.1 Groundwater Treatment ..... 17

    3.2.2 Groundwater Regulations ..... 17

3.3 Water Supply Alternatives Discussion ..... 18

    3.3.1 Groundwater Supply Alternatives for Consideration in the Environmental Impact Report ..... 18

**4.0 Proposed Demand .....20**

4.1 Proposed Land Use ..... 20

4.2 Potable Water and Non-Potable Water Demand Projections..... 20

4.3 Fire Flow Requirements ..... 21

4.4 Peaking Factors and Supply Requirements..... 22

    4.4.1 Potable Water Buildout ADD, MDD, and PHD Projections..... 22

    4.4.2 Non-Potable Water Irrigation + Fire Flow Projection ..... 24

**5.0 System Operating Criteria .....28**

5.1 Transmission / Distribution Design Criteria ..... 28

5.2 Tank and Booster Pump Station Sizing Criteria ..... 29



**CROWS LANDING INDUSTRIAL BUSINESS PARK  
WATER SUPPLY (POTABLE & NON-POTABLE) INFRASTRUCTURE AND FACILITIES STUDY  
FEBRUARY 27, 2015 (UPDATED JANUARY 11, 2018)**

5.3 Tank / Booster pump Stations ..... 29

5.3.1 Tank and Booster Pump Stations ..... 29

5.3.2 Buildout Storage and Pumping Requirements ..... 29

**6.0 Potable and Non-Potable Water Infrastructure ..... 32**

6.1 Proposed On-Site Potable Water Infrastructure ..... 32

6.2 Proposed Non-Potable Water Infrastructure ..... 35

**7.0 Water System Modeling ..... 38**

7.1 Model Development ..... 38

7.2 Modeling Assumptions ..... 38

7.3 Model Scenarios ..... 38

7.3.1 Fire Flow Analysis ..... 39

7.4 Model Results ..... 39

7.4.1 Potable Water Scenario: Average Day Demand ..... 39

7.4.2 Potable Water Scenario: Maximum Day Demand ..... 39

7.4.3 Potable Water Scenario: Peak Hour Demand ..... 40

7.4.4 Non-Potable Water Scenario: Maximum Day Irrigation Demand with Fire Flow Demand ..... 40

7.4.5 Pressure System Interties/Zones ..... 40

**8.0 Findings ..... 42**

8.1 Supply ..... 42

8.2 Infrastructure ..... 42

**9.0 References ..... 45**

**CROWS LANDING INDUSTRIAL BUSINESS PARK  
WATER SUPPLY (POTABLE & NON-POTABLE) INFRASTRUCTURE AND FACILITIES STUDY  
FEBRUARY 27, 2015 (UPDATED JANUARY 11, 2018)**

**LIST OF TABLES**

Table ES.1: Summary of Total Project Water System Construction Costs  
Table 2.1: Groundwater Constituents of Concern for Crows Landing, COP, and Newman  
Table 4.1: Required Fire Flows  
Table 4.2: Projected Buildout Potable Water Demand  
Table 4.3: Projected Phase 1 Potable Water Demand  
Table 4.4: Projected Phase 2 Potable Water Demand  
Table 4.5: Projected Phase 3 Potable Water Demand  
Table 4.6: Projected Buildout Non-Potable Water Irrigation Demand  
Table 4.7: Projected Phase 1 Non-Potable Water Irrigation Demand  
Table 4.8: Projected Phase 2 Non-Potable Water Irrigation Demand  
Table 4.9: Projected Phase 3 Non-Potable Water Irrigation Demand  
Table 5.1: System Service Criteria  
Table 5.2: Water Main Velocity Criteria  
Table 5.3: Potable Water Storage Requirements  
Table 5.4: Buildout Water Storage Requirements  
Table 6.1: Estimated Onsite Phase 1 Potable Water System Construction Costs  
Table 6.2: Estimated Onsite Phase 2 Potable Water System Construction Costs  
Table 6.3: Estimated Onsite Phase 3 Potable Water System Construction Costs  
Table 6.4: Estimated Phase 1 Non-Potable Water System Construction Costs  
Table 6.5: Estimated Phase 2 Non-Potable Water System Construction Costs  
Table 6.6: Estimated Phase 3 Non-Potable Water System Construction Costs

**LIST OF FIGURES**

Figure 1.1: Crows Landing Industrial Park – Conceptual Phasing Map  
Figure 7.1: Phase 1 Potable Water System Layout Peak Hour Demand Pressures and Velocities  
Figure 7.2: Phase 2 Potable Water System Layout Peak Hour Demand Pressures and Velocities  
Figure 7.3: Phase 3 Potable Water System Layout Peak Hour Demand Pressures and Velocities  
Figure 7.4: Phase 1 Non-Potable Water System Layout Peak Fire Flow Analysis  
Figure 7.5: Phase 2 Non-Potable Water System Layout Peak Fire Flow Analysis  
Figure 7.6: Phase 3 Non-Potable Water System Layout Peak Fire Flow Analysis

**LIST OF APPENDICES**

Appendix A - Groundwater Resources Impact Assessment  
Appendix B - CASGEM Well Data and Model Data Export  
Appendix C - Water Supply Alternatives for Consideration in the Environmental Impact Report

## EXECUTIVE SUMMARY

The proposed Crows Landing Business Park Project (Project) will require the conversion of the decommissioned Crows Landing Air Facility (CLAF) and surrounding agricultural area to industrial use. Planning for this project requires an evaluation of viable water supply sources in the area. Changes in water demands due to land use conversions also need to be considered in order to accommodate various demand scenarios for both potable and non-potable water. Once the demands are determined the layout, alignment, and sizing of the water systems need to be designed to serve the Project area. The aim of this study was to establish viable supply sources, demands, and system layout and sizing of potable and non-potable water facilities for the Project.

Possible water sources for the project area include both surface water and groundwater. Surface water sources in the area include the Delta-Mendota Canal (DMC), the California Aqueduct (CAQ), and the San Joaquin River. To access these sources requires entitlements or rights which the Project does not have. Additionally, these allocations have been unreliable in recent years due to drought. The lack of entitlements and reliability of surface water have caused the Project to rely solely on groundwater as the water supply source. No surface water is planned to be used by the Project. Although there has been a decline in groundwater elevation in the project area, the groundwater has been deemed stable and a suitable water source for the Project based on the findings in *Groundwater Resources Impact Assessment: Crows Landing Industrial Business Park* prepared by Jacobson, James and Associates (Appendix A).

Water demands were determined by the Project's total developable acres and total water demand rate recommended by the Stanislaus County Department of Public Works (SCDPW). It is projected that 60% of this total demand will be for potable use and the remaining 40% for non-potable use. These demands must consider average day, maximum day, and peak hour demands as well as operational and emergency storage for the potable water system. In order to accommodate these demands, Phases 1A, 2, and 3 of the Project will require the installation of a well with wellhead treatment during each phase, for a total of four new potable water wells. Phases 1A and 2 will include the addition of water storage tanks. The non-potable system requires the installation of a well, storage tank, and booster pump during Phase 1B and fire hydrants for Phases 1, 2, and 3 in order to meet the area's irrigation and fire flow demands. The Project's potable water system consists of 12-inch PVC pipes, while the non-potable system includes 12- and 18-inch PVC pipes. The master planned water system for the Project and associated costs are presented in Table ES-1.

The most recent revisions to this study incorporate the findings of a water supply alternatives study to address the State Water Resources Control Board's Division of Drinking Water requirements for new water service areas to evaluate the feasibility of consolidation, annexation, or extension of water services. The study evaluated three alternatives: A) combine CLIBP with the Crows Landing Community Services District water system, B) pursue a new permit for CLIBP alone, and C) combine CLIBP with the City of Patterson water system.



CROWS LANDING INDUSTRIAL BUSINESS PARK  
 WATER SUPPLY (POTABLE & NON-POTABLE) INFRASTRUCTURE AND FACILITIES STUDY  
 FEBRUARY 27, 2015 (UPDATED JANUARY 11, 2018)

Description	Cost
<b>Phase 1A</b>	
Potable Water System	\$ 10,771,000.00
Non-Potable System	\$ 2,213,000.00
<b>Phase 1B</b>	
Potable Water System	\$ 3,275,000.00
Non-Potable System	\$ 9,283,000.00
Total for Phase 1	<b>\$ 25,542,000.00</b>
<b>Phase 2</b>	
Potable Water System	\$ 12,180,000.00
Non-Potable Water System	\$ 3,735,000.00
Total for Phase 2	<b>\$ 15,915,000.00</b>
<b>Phase 3</b>	
Potable Water System	\$ 8,597,000.00
Non-Potable Water System	\$ 2,981,000.00
Total for Phase 3	<b>\$ 11,578,000.00</b>
<b>Total Estimated Opinion of Probable Construction Cost</b>	<b>\$ 53,035,000.00</b>

**CROWS LANDING INDUSTRIAL BUSINESS PARK  
WATER SUPPLY (POTABLE & NON-POTABLE) INFRASTRUCTURE AND FACILITIES STUDY  
FEBRUARY 27, 2015 (UPDATED JANUARY 11, 2018)**

## **1.0 INTRODUCTION**

Section 1 states the study background and purposes, Study Area, and overall system planning assumptions.

### **1.1 STUDY BACKGROUND**

The Crows Landing Industrial Business Park project (Project) is an approximately 1,528-acre conceptually planned development that encompasses the reuse of the former Crows Landing Air Facility, which was decommissioned by NASA in the late 1990s.

The Project site lies west of State Route 33 and east of Interstate 5, southwest of Patterson, and approximately 1 mile west of the unincorporated community of Crows Landing. The Project site is further bounded on the east by Bell Road, on the south by Fink Road, on the west by Davis Road, and on the north by Marshall Road and State Route 33. The Delta-Mendota Canal traverses the southern portion of the Project in a northwest/southeast direction. Little Salado Creek enters the Project site along the western property boundary slightly northeast of the Delta-Mendota Canal, and discharges to the Marshall Drain. The Marshall Drain then transitions to an underground pipe near the intersection of Marshall Road and State Route 33. The Project site topography generally slopes down in a northeasterly direction with an elevation change of approximately 80 feet, with the lowest elevation near the intersection of State Route 33 and Marshall Road. The Project site falls within the Del Puerto Water District. The site includes vehicle and aviation improvements associated with the former air facility and approximately 1,200 acres which are currently being used for agricultural purposes. Figure 1.1 provides a project layout and phasing plan for the development.

The Study Area includes the Project site, the Western Hills Water District water treatment plant, and large surface water storage and transport systems in the area including the California Aqueduct and the Delta Mendota Canal, and groundwater within the San Joaquin River Hydrologic Region.

### **1.2 STUDY PURPOSE**

This Water System (Potable and Non-Potable) Infrastructure and Facilities Study provides information required for the County to better assess the feasibility of the planned development by defining the necessary potable and non-potable water system infrastructure improvements. The scope of this plan includes the following major tasks:

- Discuss alternative potable and non-potable water supply sources and treatment considerations
- Determine the projected potable and non-potable water demands for the Project, based on the proposed land uses
- Determine the overall preliminary potable and non-potable water system layout and sizing, using the Land Use Plan and the Circulation Plan as a guide for preliminary alignments and locations.

The findings of this study are based on available information and are subject to change once more detailed engineering analyses are performed as the Project progresses.

**CROWS LANDING INDUSTRIAL BUSINESS PARK  
WATER SUPPLY (POTABLE & NON-POTABLE) INFRASTRUCTURE AND FACILITIES STUDY  
FEBRUARY 27, 2015 (UPDATED JANUARY 11, 2018)**

**1.3 OVERALL SYSTEM PLANNING ASSUMPTIONS**

Stanislaus County Department of Public Works Standards and Specifications Section 6.4 states:

The water system shall conform to the requirements of the water district in which the development is located. The governing water district shall sign the improvement plans prior to the plans being approved by the County. If the development is located outside of a water district, then the water system shall be designed and constructed in conformance with the City of Modesto water standards. Compliance with the applicable water standards shall be certified by the design engineer.

Overall planning assumptions for the water system in this study are determined based on a comparative analysis of water duties for local cities and agencies, including the *City of Modesto Standard Specifications 2014* (COM 2014). In the case where design guidelines and criteria are not published by a local agency, assumptions are made based on typical values published in the *Water Distribution System Handbook* (Mays, 2000).

## 2.0 BACKGROUND INVESTIGATION

### 2.1 TOPOGRAPHY

The Crows Landing Industrial Business Park project (Project) site terrain is composed of gently sloping land. Terrain in the Project site rises from about 120 feet above sea level in the northeastern corner of the development, near the Marshall Road / State Route 33 intersection, to around 200 feet above sea level at the southwestern corner of the development immediately north of Fink Road.

### 2.2 EXISTING CONDITIONS AT CROWS LANDING AIR FACILITY

The Crows Landing Air Facility (CLAF) was commissioned as an auxiliary airfield to Naval Auxiliary Air Station Alameda in 1942 and decommissioned by the National Aeronautics and Space Administration (NASA) as the Crows Landing Flight Facility/NASA Ames Research Center in 1999. In the same year, the U.S. Congress passed Public Law 106-82 which directed NASA to convey the CLAF to Stanislaus County in several phases following environmental remediation activities. In 2004, NASA conveyed 1,352 acres of the CLAF, known as Parcel A, to the County. One hundred seventy-six (176) acres remain to be conveyed to the County once environmental remediation activities have been completed. Currently, the land is being used for agricultural purposes. Historically, as much as approximately 1,200 acres have been used for agricultural production, but the total amount of land in production has varied greatly due to water availability.

### 2.3 EXISTING WATER SOURCES AND FACILITIES

Existing water sources within and near the Project site include both natural and man-made surface water conveyance facilities and groundwater wells as described in this section.

#### 2.3.1 Surface Water Background

The term “surface water” refers to water from natural precipitation which is made available through natural or man-made bodies of water such as canals, lakes, reservoirs or rivers. Surface water sources in the vicinity of the Project site include the Delta-Mendota Canal (DMC), the California Aqueduct (CAQ), and the San Joaquin River. The ephemeral Salado Creek and the Little Salado Creek periodically contain flows in the Project vicinity, but do not contain flows year-round. Therefore, these will not be considered as potential sources for potable nor non-potable use for the project.

##### 2.3.1.1 Delta-Mendota Canal

A portion of the DMC crosses the project site. The DMC, completed in 1951, is part of the federal Central Valley Project (CVP) and is operated by the United States Department of the Interior Bureau of Reclamation (USBR) and the San Luis Delta Mendota Water Authority (SLDMWA). The DMC carries water pumped from the Sacramento-San Joaquin Delta (Delta) southeasterly along the west side of the San Joaquin Valley for agricultural as well as Municipal and Industrial (M&I) uses, for use in the San Luis Unit, for replacement of San Joaquin River water stored at Friant Dam, and for use in the Friant-Kern and Madera systems.

**CROWS LANDING INDUSTRIAL BUSINESS PARK  
WATER SUPPLY (POTABLE & NON-POTABLE) INFRASTRUCTURE AND FACILITIES STUDY  
FEBRUARY 27, 2015 (UPDATED JANUARY 11, 2018)**

Water from the DMC is primarily used for irrigation, though it is also used for M&I purposes, as well as environmental purposes for fish & wildlife and habitat restoration. In an average year, deliveries of CVP water total approximately 7 million acre-feet per year (AFY), with 5 million AFY of that total used for agricultural purposes, 600,000 AFY for M&I uses, and 1.2 million AFY used for environmental purposes including fish & wildlife habit. (USBR, M&I, 2014). Deliveries from the CVP are determined by the USBR on an annual basis through allocations, or portions, of contracted water amounts. During years with wetter conditions and more plentiful supplies, allocations are higher. Conversely, during dryer years, allocations are reduced.

Most CVP contractors have provisions in their contracts allowing the use of CVP water for M&I purposes, though these contractors may also have their own regulations prohibiting the use of this water for M&I purposes. Water allocations for M&I purposes are governed by the USBR's Municipal and Industrial Water Shortage Policy, which was most recently finalized in 2005. (USBR, M&I, 2005). This current policy assigns a higher priority to M&I allocations than agricultural allocations. For example, in early 2014, CVP water allocations were estimated to be 0% of contracted amounts for agricultural purposes due to the dry conditions for that year. By comparison, allocations for M&I uses were much higher at up to 50% of contracted amounts. The USBR has recently issued a draft environmental impact statement which considers alternatives to the current policy. (USBR, M&I, 2014). This draft environmental impact statement describes five alternatives for revisions to the current policy:

Alternative 1: "No Action", resulting in no change to the current policy

Alternative 2: Equal Agriculture and M&I allocations

Alternative 3: Full M&I Allocation, regardless of agricultural allocation

Alternative 4: Updated M&I Water Service Policy –similar to "No Action" alternative, though with some revisions to determination of historic use

Alternative 5: M&I Contractor Suggested Water Service Policy –similar to Alternative 4, though with modifications to CVP operational practices to meet public health & safety requirements.

As of this report, a preferred alternative has not been identified.

All waters conveyed by and stored within the CVP are fully appropriated; therefore, surface water must be obtained from permitted users that are willing to sell portions of their entitlements. Existing water districts near the Project and their corresponding CVP water contract entitlements include: the Del Puerto Water District, with a contract entitlement of 140,210 acre-feet per year; Patterson Irrigation District with a contract entitlement of 22,500 acre-feet per year; and West Stanislaus Irrigation District with a contract entitlement of 50,000 acre-feet per year (USBR, Contractors List, 2014).

#### 2.3.1.2 California Aqueduct

The Project site is approximately 2.5 miles from the California Aqueduct (CAQ). The CAQ is part of the State Water Project (SWP), the nation's largest state-built water conveyance and power development system, operated by the California Department of Water Resources (DWR). Water from the Delta is pumped by the Harvey O. Banks Pumping Plant (Banks Pumping Plant) into the 440-mile long concrete-lined canal which ultimately delivers water to millions of California residents and farms. Water from the

**CROWS LANDING INDUSTRIAL BUSINESS PARK  
WATER SUPPLY (POTABLE & NON-POTABLE) INFRASTRUCTURE AND FACILITIES STUDY  
FEBRUARY 27, 2015 (UPDATED JANUARY 11, 2018)**

SWP is mostly used for M&I purposes, though a substantial portion is also used for agricultural, as well as environmental purposes.

Water deliveries from the SWP are based on long-term contracts between the DWR and 29 public agencies and water districts (contractors) throughout the state. These contracts specify the maximum amount of water a contractor may request each year from the SWP, commonly referred to as “Table A” water. Table A allocations to each contractor for a given year are traditionally determined by the DWR near the end of the preceding year based on predicted supplies, though the allocations can be adjusted later during the year. As an example, 2014 water allocations from the SWP were initially predicted in November 2013 to be 5% of Table A amounts, though were later reduced to 0% in January 2014 due to historic dry conditions. However, later in 2014, allocations were increased back to 5% of Table A amounts in April 2014, and then further increased to 20% in May 2014 due to late precipitation and successful conservation efforts. (DWR Notices, 2013-2014).

Two local SWP water contractors near the Project site receive water from the CAQ: the Oak Flat Water District (OFWD) and the Western Hills Water District (WHWD). OFWD has a Table A contract amount of 5,700 acre-feet of water for agricultural use. (DWR, 2014) WHWD supplies water to the Diablo Grande master-planned development, located west of the Project. WHWD receives water from the CAQ through an agreement with the Kern County Water Agency, which allows for deliveries of up to 8,000 acre-feet of water from the CAQ. (DWR, 2004). WHWD treats the raw water from the CAQ with an existing 1 MGD conventional treatment plant, Public Water System No. 5010039. The Diablo Grande development currently utilizes water from the CAQ for all of its normal water needs, though groundwater from WHWD sources may be utilized in the event of catastrophic emergencies.

### 2.3.1.3 San Joaquin River

The Project site lies approximately 4 miles west of the San Joaquin River. In the vicinity of the Project, the San Joaquin River runs in a northwesterly direction, roughly parallel to the Coast Range Mountains, draining towards the Sacramento-San Joaquin Delta, which ultimately discharges to the San Francisco bay. The upstream hydrology of the river’s watershed has been highly modified by man since the early 20<sup>th</sup> century.

The State has prohibited use of the river as a drinking water source; however, some water is pumped for non-potable irrigation uses by local irrigation districts. (City of Patterson, UWMP 2010) The City of Patterson further discusses the possibility for use of San Joaquin River flows to meet non-potable demands, as well as for groundwater recharge purposes in its 2010 General Plan Update Water Supply Assessment. (2010 City of Patterson General Plan WSA). This possibility is based on the “senior” pre-1914 water rights of the Patterson Irrigation District which allows the full use of their allotted water flows of 340 ac-ft/day without restrictions. In addition, the Westside Irrigation District may utilize up to 545 ac-ft/day, but is subject to restrictions as it is a “junior” post-1914 water rights holder. However, restrictions had not been placed on the Westside Irrigation District in the 30 years prior to that report. (City of Patterson, UWMP 2010) In addition, both the WSID and PID have current “Warren Act” contracts with the USBR that allow water obtained from the San Joaquin River to be conveyed and stored within the DMC and other downstream CVP facilities. PID’s contract was recently renewed, though WSID’s will expire in 2015, and has recently been circulated for environmental approval for renewal. (USBR, Warren Act, 2014 & 2015)

**CROWS LANDING INDUSTRIAL BUSINESS PARK  
WATER SUPPLY (POTABLE & NON-POTABLE) INFRASTRUCTURE AND FACILITIES STUDY  
FEBRUARY 27, 2015 (UPDATED JANUARY 11, 2018)**

Although PID and WSID have long-standing rights to San Joaquin River, these districts are still subject to curtailments of water diversions from the river in times of drought or limited supply. These curtailments, implemented by the State Water Resources Control Board (SWRCB), can apply to all water right holders, including those with pre-1914 senior water rights. On January 17, 2014, the SWRCB issued an informational notice to all water right holders throughout the state warning of potential curtailments due to dry conditions. This notice was followed by a May 27, 2014 curtailment notice to all water right holders within the Sacramento and San Joaquin River watersheds. (SWRCB 2014) The notice directed the immediate curtailment of all diversions for “junior” post-1914 water right holders, except under certain conditions. In addition, the notice warned of potential curtailments even for “senior” pre-1914 water right holders, which are typically not subject to limitations on diversions. These curtailments were eventually relieved later in 2014. In 2015, water rights were curtailed due to unprecedented drought conditions.

#### 2.3.1.4 Surface Water Reliability

The reliability of surface water as a source of supply depends on a combination of factors, including the availability of source water based on seasonal rainfall and storage, the condition of the conveyance facilities, and competing demands. In addition, both the DMC and CAQ have been subject to shutdowns due to emergencies, due to scheduled maintenance and repairs, and due to environmental concerns. As previously discussed, water deliveries from the DMC and CAQ have been severely reduced in recent times from contracted amounts due to drought conditions. Furthermore, diversions of surface water from natural courses may be curtailed by the SWRCB due to drought conditions, even for pre-1914 water rights holders.

The reliability of surface water as a supply may be improved by constructing additional improvements to the system. As an example, The Delta-Mendota Canal/California Aqueduct Intertie project (Intertie) was completed in 2012 as a means to eliminate the DMC conveyance conditions caused by a restricted Tracy Pumping Plant capacity. Modeling studies indicate that the Intertie project will enable the CVP to deliver a long-term average of 35,000 acre-feet per year of additional water to its service area by enabling the CVP to use available capacity in the CAQ (USBR Record of Decision, 2009). Surface water reliability may also be extended through creative banking agreements or other transfers of water rights. The WHWD successfully “banked” 2000 acre-feet of water from 2010 to 2013 through agreements for transfers with other irrigation districts. This water was then available for delivery from the CAQ to the WHWD, despite the fact that SWP allocations were initially limited to 0% at the beginning of 2014. (Diablo Grande 2014)

Still, efforts to improve or extend the reliability of surface water deliveries from the DMC and CAQ are costly. For example, the Intertie project did provide some improvements in operational flexibility of DMC and CAQ, though it provided only modest increases in water delivery for the price. The total construction cost of the Intertie project was approximately \$28M, yet only achieved an estimated average of 35,000 acre-feet per year of additional CVP water deliveries, or about 0.5% of the total annual delivery of 7 million acre-feet. Similarly, water delivered through banking agreements or transfers from other contractors often must be purchased at a premium price. Furthermore, such agreements or transfers may also be temporary, with no guarantee of future renewal.

**CROWS LANDING INDUSTRIAL BUSINESS PARK  
WATER SUPPLY (POTABLE & NON-POTABLE) INFRASTRUCTURE AND FACILITIES STUDY  
FEBRUARY 27, 2015 (UPDATED JANUARY 11, 2018)**

**2.3.2 Groundwater Background**

The term “groundwater” refers to water held underground in naturally occurring aquifers which must be extracted through the use of wells. The majority of the area surrounding the Project site is heavily reliant on groundwater as a water supply source for agricultural and urban use.

The Project site is located within the Delta-Mendota Sub-Basin, a portion of the San Joaquin River Hydrologic Region. The geological characteristics of the groundwater basin consist of the Tulare formation, terrace deposits, alluvium, and flood-basin deposits. Regionally, the upper water bearing zone and lower water bearing zone are separated by the Corcoran clay layer, a relatively impermeable layer lying between 220 ft. to 300 ft. below the ground surface of the project site.

**2.3.2.1 Existing Groundwater Facilities**

Groundwater wells are heavily relied-upon throughout the vicinity of the Project site for potable and non-potable uses. The nearby City of Patterson and community of Crows Landing both rely exclusively on groundwater wells to meet potable water demands. There are four existing active wells onsite, though details regarding their construction (e.g. type of screens, depths) are unknown. Although the *Groundwater Resources Impact Assessment* prepared by Jacobson James & Associates, Inc. (Appendix A) confirmed that there are adequate groundwater supplies available for the Project, the exact supply capacity of the existing wells cannot be determined without further study. In addition, an existing 16-inch water transmission main delivers emergency water from a groundwater well, located along Davis Road west of the northern area of the Project, to the Diablo Grande development located approximately 7 miles west of the Project. The distribution main alignment continues north from the well site then runs west along West Marshall Road, south along Ward Road, and west along Oak Flat Road.

**2.3.2.2 Groundwater Level Trends**

Several previous studies over the last several years have summarized measurements of groundwater elevations in the vicinity of the Project site. The results of these studies can be used to ascertain the sensitivity of the aquifer to periods of drought, and the sustainability of groundwater as a water source. The results of these studies suggest that, over time, the groundwater levels at the Project site and in the vicinity are stable. This would imply that groundwater resources in the vicinity of the Project site are not in an overdraft condition. However, as part of the Sustainable Groundwater Management Act, the State of California Department of Water Resources (DWR) recently released a final list of California groundwater basins that are in a state of critical overdraft (<http://water.ca.gov/groundwater/sgm/index.cfm>, accessed 2/15/2016). This final list includes the Delta-Mendota groundwater basin and therefore includes the Project site. While the area near the Project site may appear to have stable groundwater levels, the basin as a whole shows areas of declining water elevations. This section describes the findings and results obtained from pertinent studies of local groundwater elevations.

**2.3.2.2.1 California Department of Water Resources, Bulletin 118**

The California Department of Water Resources (DWR) originally published Bulletin 118 in 1975, which provided a characterization of 248 of 461 identified groundwater basins. Bulletin 118 was updated most recently in 2003, though errata have been published more recently. As a supplement to Bulletin 118, the DWR publishes a separate description for each sub-basin within the 10 hydrologic regions. The description for the Delta-Mendota Sub-basin, updated in 2006, indicates the general trend for the



**CROWS LANDING INDUSTRIAL BUSINESS PARK  
WATER SUPPLY (POTABLE & NON-POTABLE) INFRASTRUCTURE AND FACILITIES STUDY  
FEBRUARY 27, 2015 (UPDATED JANUARY 11, 2018)**

groundwater level in the sub-basin showed an increase from 1970 through 1985, consistent with increased surface water deliveries to the San Joaquin Valley, with a maximum groundwater level of 7.5 feet above the 1970 water level. From 1985 through 1994 groundwater levels declined. The groundwater level in 1994 was similar to the 1970 groundwater level. In 1995 the groundwater level rose to 2.2 feet above the 1970 level. Since 1995, groundwater levels have fluctuated around 2.2 feet above the 1970 water level until 2000.

Based on a specific yield of 11.8 percent, the Delta-Mendota Sub-Basin has a total of 26,600,000 acre-feet of groundwater stored to a depth of 300 feet as of 1995. The total storage capacity is estimated to be 30,400,000 acre-feet to a depth of 300 feet and 81,800,000 acre-feet to the base of fresh groundwater (DWR, 2003).

#### 2.3.2.2.2 San Luis Delta Mendota Water Authority, Groundwater Management Plan

In 1995, the agencies comprising the SLDMWA entered into an agreement to jointly fund the preparation of a coordinated regional groundwater management plan (GMP). The groundwater management area (GMA) covered by the GMP includes portions of the Tracy and Delta-Mendota sub-basins of the San Joaquin River hydrologic region, and fully encompasses the Project site. This GMP was most recently updated in 2011.

The study includes an analysis of groundwater level trends in the GMA between 1993 and 2008. Findings of the study characterize the groundwater levels in the GMA as generally hydrologically balanced. The study further indicates minimal apparent net change in groundwater level elevations over the study period, which seem to indicate equilibrium in the GMA between use and recharge. The study does describe consistent declines in elevation for certain localized areas of the GMA, such as areas west of Newman, which could be indicative of a developing local overdraft condition. As noted previously, DWR has listed the Delta-Mendota groundwater basin, which includes areas within the GMA and includes the Project site, as being in a state of overdraft (<http://water.ca.gov/groundwater/sgm/index.cfm>, accessed 2/15/2016).

Regarding the Project site, the study indicates some decline in groundwater elevation of approximately up to 8 ft. between 1998 and 2008. However, the study also indicates an overall increase in groundwater elevations from 1993 to 2008 in the area of the Project site of up to approximately 8 ft. This groundwater elevation data would suggest that, over time, the groundwater in the area of the Project site has been in a hydrologically balanced condition.

#### 2.3.2.2.3 City of Patterson

Owing to COP's proximity to the project within the Delta-Mendota Subbasin and the fact that its deep municipal wells are similar to those which could serve the Project, the existing groundwater well data and information for the COP is considered representative of the deep aquifer groundwater conditions at the Project site. A recent review of groundwater within and around the COP is included in *the Supplement to Water Supply Assessment for Arambel Business Park/KDN Retail Center*, prepared by Kenneth D. Schmidt and Associates (KSA) in 2013. The study indicates that between 1990 and 2012 water levels for wells tapping the upper aquifer above the Corcoran Clay Layer were relatively stable within the study area, though with an average decline of 0.3 feet per year. This decline was attributed to a number of dry years during this period. The study also discusses water levels within the lower aquifer below the Corcoran Clay layer. Manual depth measurements were taken of 4 different wells

**CROWS LANDING INDUSTRIAL BUSINESS PARK  
WATER SUPPLY (POTABLE & NON-POTABLE) INFRASTRUCTURE AND FACILITIES STUDY  
FEBRUARY 27, 2015 (UPDATED JANUARY 11, 2018)**

which tapped the lower aquifer within the City of Patterson between 2006 and May 2013. These measurements did not indicate any decline in water levels during this period.

**2.3.2.2.4 Former NASA Crows Landing Flight Facility, Groundwater Monitoring**

Groundwater monitoring studies focusing on the Project site and the area in the immediate vicinity of the Project site are ongoing as part of Navy's Base Realignment and Closure Program. The most recent study available for analysis was prepared in June 2014, and provides the results of groundwater levels in monitoring wells from April 2013 through February 2014 at the Project site. This study indicates that groundwater levels within the upper and shallow water-bearing zones have declined by an average of 3.72 feet in the shallow water-bearing zone; and by 7.25 feet in the deeper water bearing zone directly above the Corcoran clay layer, compared to the groundwater levels measured in February 2013 (OTIE, 2014).

**2.3.2.2.5 California Statewide Groundwater Elevation Monitoring (CASGEM)**

The DWR established the CASGEM program to provide statewide monitoring of groundwater in response to Senate Bill X7 6, which added provisions requiring groundwater monitoring to the Water Code. CASGEM maintains an online system with available well details and groundwater information at numerous locations throughout the state. (<http://www.water.ca.gov/groundwater/casgem/>)

CASGEM includes detailed information for recent groundwater elevations for 4 wells within the project area:

- Local Well ID MP45.78R: An existing irrigation well just east of Davis Road, approximately one mile north of the Fink Road / Davis Road intersection. CASGEM records indicate this well has a total depth of 721 feet. Water level measurements indicate a drop of approximately 14 ft between March 15, 2012 and March 14, 2014.
- Local Well ID's P259-1, P259-2 and P259-3: Three monitoring wells with total depths of 430 ft, 255 ft, and 115 ft, respectively. Water level measurements indicate a drop of approximately 6 to 8 ft. in all three wells between November 16, 2011 and December 22, 2014.

Measurements from these wells indicate a modest decline in groundwater elevation data between 2011 and 2014; however, earlier groundwater elevation data is not available for these wells through CASGEM. Additionally, 2013 and 2014 were abnormally dry years which is likely the reason for the decline in groundwater levels during this period. Given the relatively short monitoring period and the abnormally dry conditions during this period, the water level information does not necessarily indicate an overdraft condition, despite the decline between 2011 and 2014. Copies of information obtained from CASGEM for these wells are included in the Appendices.

**2.3.2.2.6 Groundwater Resources Impact Assessment**

*Groundwater Resources Impact Assessment* prepared by Jacobson James & Associates, Inc. (Appendix A) assesses the groundwater resources present at the Project site and the impact of groundwater pumping. The site has a shallow unconfined aquifer as well as a deeper, confined aquifer separated a relatively impermeable regional aquitard layer referred to as the Corcoran Clay. The Project potable water supply will be developed using new wells installed into the confined aquifer beneath the site. The Project will develop a non-potable water supply using a combination of the existing irrigation wells that derive water from both the shallow and deep aquifer (assumed to provide 834 acre-feet per year based on

**CROWS LANDING INDUSTRIAL BUSINESS PARK  
WATER SUPPLY (POTABLE & NON-POTABLE) INFRASTRUCTURE AND FACILITIES STUDY  
FEBRUARY 27, 2015 (UPDATED JANUARY 11, 2018)**

historical pumping rates), and new non-potable supply wells installed into the shallow aquifer beneath the site to meet non-potable Project water demand in excess of what is provided by the existing irrigation wells.

Recent reductions in surface water deliveries due to drought have caused increased pumping of groundwater in the area. Coupled with low levels of precipitation, the aquifer has been classified as being in a state of overdraft. This area and the area northwest of the site have experienced pronounced cones of depression in the fall. Despite these low groundwater levels, the aquifer is stable as indicated by consistent water elevations by season.

*The Groundwater Resources Impact Assessment (JJ&A, 2016) evaluated the on-site groundwater withdrawals to determine the potential impacts on on-site pumping on the local groundwater conditions. The results showed that groundwater withdrawals to support the Project could result in a drawdown within 1% to 10% of the total available saturated thickness of the aquifer, thus having a minimal impact on the groundwater storage conditions. The study also indicated that the potential for limited land subsidence does exist due to pumping from the confined aquifer beneath the Project site; however, there are no other impacts to any groundwater dependent ecosystems or water quality. Ongoing groundwater monitoring is recommended to regularly evaluate groundwater conditions to prevent adverse impacts in the future*

### 2.3.2.3 Groundwater Quality and Constituents

Groundwater obtained from the region's aquifers has been known to contain constituents, such as iron, manganese, arsenic, nitrates and nitrites, and other inorganic and organic compounds.

According to monitoring reports taken from the SWRCB website (<https://sdwis.waterboards.ca.gov/PDWW/> accessed 2/15/16), groundwater in the surrounding area, specifically the Crows Landing Community Services District (CLCSD) area, has been found to contain several contaminants that exceed the state maximum contaminant level (MCL). If the Project intends to source its water supply from the same aquifers, wellhead treatment systems may be necessary. These contaminants include:

- Nitrate
- Nitrite
- Hexavalent chromium
- 1,2,3-trichloropropane

Nitrate and nitrite (as nitrate + nitrite) has been detected as high 5,424 milligrams per liter (mg/L) in 2012. Hexavalent chromium has been detected as high as 15 micrograms/liter (µg/L) in 2014. 1,2,3-trichloropropane has been detected as high as 0.5 µg/L in 2009. It is not certain that the groundwater within the Project area contains the same contaminants as the groundwater utilized by the CLCSD. Comprehensive water quality samples of groundwater pumped from wells which are located nearby the study area as well as from test and production wells onsite would need to be evaluated to more fully

**CROWS LANDING INDUSTRIAL BUSINESS PARK  
WATER SUPPLY (POTABLE & NON-POTABLE) INFRASTRUCTURE AND FACILITIES STUDY  
FEBRUARY 27, 2015 (UPDATED JANUARY 11, 2018)**

ascertain the constituent, which may be expected in supplies pumped from new wells and the required methods for treatment.

In addition to the CLCSD data, initial test results of groundwater obtained from wells in the region were obtained from the SWRCB, formerly known as California Department of Public Health (CDPH) and constituents of concern were noted for various regions. For this project, the data for the COP and Newman are listed in Table 2.1 (CDPH 2014).

**Table 2.1 – Groundwater Constituents of Concern for Crows Landing, COP, and Newman**

<b>Constituent</b>	<b>Result Range</b>	<b>MCL</b>	<b>Units</b>
Alkalinity (Total) as CaCO <sub>3</sub>	78-381.1	-	mg/l
Aluminum	30-120	1000	µg/l
Arsenic	2-7.2	10	µg/l
Barium	15.5-560	1000	µg/l
Bicarbonate Alkalinity	78-407.4	-	mg/l
Boron	300-600	-	µg/l
Bromodichloromethane (THM)	0.5-0.9	-	µg/l
Bromoform (THM)	0.7-12.3	-	µg/l
Calcium	47-142.4	-	mg/l
Chloride	32-2,100	500	mg/l
Chloroform (THM)	0.9-1.49	-	µg/l
Chromium (Total)	5.8-29.3	50	µg/l
Chromium (Hexavalent)	3.5-36	10	µg/l
Color	3-9	15	units
Copper	4-53	1000	µg/l
Dibromoacetic Acid (DBAA)	1-2	-	µg/l
Dibromochloromethane (THM)	0.5-1.2	-	µg/l
Dibromochloropropane (DBCP)	0.01-0.04	0.2	µg/l
Dichloroacetic Acid (DCAA)	19.9	-	µg/l
Fluoride (natural source)	0.1-0.4	2	mg/l
Gross Alpha	1.26-12.1	15	pci/l
Gross Alpha MDA95	1.09-3.09	-	pci/l
Haloacetic Acids (5) (HAA5)	2-49.3	60	µg/l
Hardness (Total) as CaCO <sub>3</sub>	237-1901	-	mg/l

**CROWS LANDING INDUSTRIAL BUSINESS PARK  
WATER SUPPLY (POTABLE & NON-POTABLE) INFRASTRUCTURE AND FACILITIES STUDY  
FEBRUARY 27, 2015 (UPDATED JANUARY 11, 2018)**

<b>Constituent</b>	<b>Result Range</b>	<b>MCL</b>	<b>Units</b>
Iron	22-300	300	µg/l
Lead	0.3	-	µg/l
Magnesium	4.2-130	-	mg/l
Manganese	10-19	50	µg/l
Mercury	0.03-32.2	2	µg/l
Monobromoacetic Acid (MBAA)	1.1-1.8	-	µg/l
Monochloroacetic Acid (MCAA)	3.3-5.7	-	µg/l
Nickel	1-17	100	µg/l
Nitrate (as NO <sub>3</sub> )	0.5-92	45	mg/l
Nitrate + Nitrite (as N)	565-12000	10000	µg/l
Nitrite (as N)	900	1000	µg/l
Perchlorate	3.5	6	µg/l
Ph (Laboratory)	6.1-8.2	-	
Potassium	2.1-4.7	-	mg/l
RA-226 for CWS or Total RA for NTNC by 903.0	0.039	-	pci/l
RA-226 or Total RA by 903.0 C.E.	0.174-0.232	-	pci/l
Radium-228	0.009	-	pci/l
Radium-228 MDA95	0.286-0.319	-	pci/l
Radium, Total, MDA95-NTNC Only, by 903.0	0.366	-	pci/l
Selenium	3-10	50	µg/l
Sodium	58-350	-	mg/l
Specific Conductance	640-5700	1600	us
Sulfate	18-688	600	mg/l
Tetrachloroethylene	2.5-13.1	5	µg/l
Total Dissolved Solids (TDS)	460-4100	1000	mg/l
Total Trihalomethanes	1.8-15.5	80	µg/l
Trichloroacetic Acid (TCAA)	2-26.1	-	µg/l
Turbidity (Laboratory)	0.05-2.9	5	ntu
Uranium	1.31-12	20	pci/l

**CROWS LANDING INDUSTRIAL BUSINESS PARK  
WATER SUPPLY (POTABLE & NON-POTABLE) INFRASTRUCTURE AND FACILITIES STUDY  
FEBRUARY 27, 2015 (UPDATED JANUARY 11, 2018)**

<b>Constituent</b>	<b>Result Range</b>	<b>MCL</b>	<b>Units</b>
Uranium MDA95	0.409-0.475	-	pci/l
Vanadium	4-10	-	µg/l
Zinc	20-260	5000	µg/l

**Note:** Other constituents that are not included in the preliminary data obtained from CDPH are also regulated and will need to be evaluated.

High iron and manganese levels were observed in many wells in the City of Modesto and COP, and in some remote cases, aluminum was also found above MCLs. Arsenic, a metal, was also found in some wells in the COP, Newman, Modesto, and other valley regions, which is an expensive compound to treat. The MCL for arsenic has recently been lowered to 10 µg/l. If arsenic is prevalent, many purveyors prefer to seek new well sites or alternative well construction methods rather than to treat for this contaminant. Additionally, TDS was found to be elevated and over the MCL in some wells. TDS reduction can be very expensive and can sometimes require the use of reverse osmosis (RO) and/or blending to achieve allowable levels.

Some organic compounds have been found in COP and Newman wells, which can be a concern and is largely dependent on sources of contamination relative to the well and plume migration patterns. These data show that dichlorobenzene, low levels of dibromochloropropane (DBCP), and low levels of tetrachloroethylene have been identified, but of these, only dichlorobenzene was over the MCL.

Nitrates, odor, and high color have been observed in numerous wells in the City of Modesto and the COP. Elevated chloride levels were observed in some COP and Tracy wells. High alpha and uranium have also been observed in some regions south of City of Modesto.

#### 2.3.2.4 Groundwater Remediation Efforts at CLAF

The Navy currently maintains a 2,000 foot pumping restriction around a contamination plume within the Project site known as the Installation Restoration Program (IRP) Site 17 Administration Area Plume. The contamination plume includes benzene and other volatile organic compounds, and is a result of underground fuel storage tanks serving the former facility. Contaminants from this plume appear to be limited to the upper aquifer above the Corcoran Clay layer. The Department of the Navy is currently conducting a program of enhanced bioremediation, including monitored natural attenuation and carbon substrate to remediate the contamination. This program has successfully reduced contamination levels, and will continue to be monitored by the Navy. The pumping restriction will remain in effect until remediation efforts have been completed (CH2M Hill Kleinfelder, A Joint Venture [KCH], 2014).

### **3.0 WATER SUPPLY ALTERNATIVES**

Alternatives for meeting the water demands of the Crows Landing Industrial Business Park (Project) may include the use of surface water, the use of groundwater, or a Conjunctive Use of both surface water and groundwater.

#### **3.1 SURFACE WATER**

As discussed previously, a portion of the DMC traverses the Project site, and the CAQ is near the Project site. These two canals would be the only nearby sources of potable surface water for the Project, as other naturally occurring surface water bodies in the Project vicinity lack the quantity or quality to be a feasible potable water source. The San Joaquin River is not considered a potential direct source of potable or non-potable surface water for the Project due to the distance of the river from the Project site, quality of the river water, and limited available surface water rights. Therefore, surface water will not be considered as a water supply source for this project.

##### **3.1.1 Surface Water Entitlements**

The County currently does not have any surface water entitlements or rights for the Project from natural sources, nor from the DMC or CAQ. Accordingly, use of the CAQ or DMC as a water supply source would require acquisition of existing water rights, entitlements, or water transfer agreements.

**Delta-Mendota Canal:** Owing to severely reduced surface water deliveries in recent years, no apparent opportunities exist at this time for the exchange of surface water from the DMC with most local water agencies as they continue working to secure adequate supplies for existing customers. Use of water from the DMC may also require approval by the USBR to allow for a conversion from agricultural use to M&I uses.

**California Aqueduct:** As discussed previously, The Diablo Grande community, a portion of the WHWD, obtains all of its normal water use from the CAQ. This water is pumped from the CAQ, and then treated at WHWD's 1- MGD treatment plant. The planned "Phase 1 Expansion" of the WHWD treatment plant will increase treatment capacity of the plant to 2 MGD. A portion of these improvements have been completed; however, the full completion of the Phase I Expansion project has been on hold since 2006.

#### **3.2 GROUNDWATER SUPPLY**

Groundwater would be used in this option to meet the water demands of the Project. The use of groundwater would likely involve treatment to remove the known constituents in the region's aquifers. Initially, well head treatment would address water quality requirements.

As discussed in section 2.3.2.2, groundwater resources in the Project area are not in an overdraft condition, and groundwater can be a viable source of water supply to the Project.

**CROWS LANDING INDUSTRIAL BUSINESS PARK  
WATER SUPPLY (POTABLE & NON-POTABLE) INFRASTRUCTURE AND FACILITIES STUDY  
FEBRUARY 27, 2015 (UPDATED JANUARY 11, 2018)**

**3.2.1 Groundwater Treatment**

Overall, many well contaminants are region-specific, and many of the constituents listed in Section 2.3.2.3 can be successfully reduced through the appropriate treatment methods, although the costs for each treatment method can vary widely.

Groundwater pumped from some nearby wells in the COP, Newman, and Modesto requires treatment and/or blending. It is likely that new municipal groundwater wells in the project would also require treatment to reduce constituents under the MCLs.

It is also possible that an effective process to drill and case new wells could substantially reduce the need for treatment of certain contaminants by avoiding the lenses whereby these compounds are concentrated.

Many metals, such as Iron and Manganese, can be cost-effectively treated by an oxidation/precipitative process. Although more costly to treat, arsenic can sometimes be treated with this process as well and/or through the use of adsorption or ion exchange resins or filter media. Nitrates can be removed by utilizing ion exchange or reverse osmosis. Taste, color, and odor may be greatly improved through the use of GAC filters, and this process can also reduce level of certain organic compounds.

The cost-effectiveness of well head treatment is typically based on the levels and type of treatment processes needed. Adsorptive types of processes may be cost-effectively applied at the well head. However, more complex treatment methods dealing with the removal of arsenic, nitrates, and volatile organic compounds (VOCs), and those requiring chemical oxidants, may be more costly to treat at the well head.

The cost of the treatment processes will be dependent on the types and amounts of the constituents to be removed, which can be further evaluated through a comprehensive test well drilling and sampling program, prior to drilling production wells.

**3.2.2 Groundwater Regulations**

Prior to 2014, extracting or pumping groundwater in California required no rights or entitlements from the State or any Federal agency. Permits were, and still are, required for the design and construction of groundwater facilities to prevent contamination. However, in regards to groundwater quantity, no approval was previously necessary that would limit the quantity of groundwater extracted from a well or wellfield.

This “pump as you please” policy has recently changed with the passage of new State legislation. SB1168, SB1319 and AB1739, otherwise known as the Sustainable Groundwater Management Act (SGMA), was signed into law by Governor Jerry Brown on September 16, 2014. The law requires local agencies to create or join a groundwater sustainability agency by 2017. The law further requires these agencies to develop a plan for managing wells and groundwater pumping by 2020 or 2022, depending on the status of their specific groundwater basin. The intent of the laws is to achieve full groundwater sustainability by 2040.

In addition, Stanislaus County has recently adopted new groundwater ordinances. In October 2013, the County Board of Supervisors adopted the Groundwater Mining and Export Prevention Ordinance which prohibits “unsustainable groundwater extraction” and export of water to areas outside of the County.



**CROWS LANDING INDUSTRIAL BUSINESS PARK  
WATER SUPPLY (POTABLE & NON-POTABLE) INFRASTRUCTURE AND FACILITIES STUDY  
FEBRUARY 27, 2015 (UPDATED JANUARY 11, 2018)**

This ordinance was further amended in 2014 to require all new wells constructed in the County after November 25, 2014 to demonstrate that pumping from the well will not constitute an “unsustainable extraction of groundwater”. The ordinance also includes provisions for exemptions from the ordinance requirements, such as for uses that extract less than two acre-feet per year, or for wells that are addressed in a Groundwater Sustainability Plan, adopted per California Water Code section 10727 et seq.

However, given the passage of the recent State legislation and County ordinance, the Project will need to demonstrate that the new groundwater pumping facilities will not create an unsustainable extraction of groundwater. Alternatively, new wells constructed by the Project may be exempt from the County’s ordinance if they are included in a Groundwater Sustainability Plan.

### 3.3 WATER SUPPLY ALTERNATIVES DISCUSSION

Utilization of surface water as the only supply source for the project is not a viable alternative. As previously discussed, the County currently has neither surface water rights nor entitlements, and there are limited opportunities for transfers from agencies with existing water rights to the DMC or CAQ. Even if rights are obtained, the delivery of surface water is still subject to extreme fluctuations depending on annual storage and rainfall.

Utilization of groundwater as the only supply source for the project is a viable alternative. Groundwater is much more reliable than surface water from the DMC or CAQ, as it would avoid interruptions due to maintenance, allocation concerns, or environmental concerns. Groundwater is also not as dependent on fluctuations in annual precipitation. As shown in prior studies, there is evidence to support that groundwater levels in the area are relatively stable over time. Monitoring and additional studies, if needed, would be required to demonstrate that the new wells would sustainably extract groundwater, but there would not be a need to purchase entitlements. The preferred alternative for the Project would be use of groundwater

Wellhead treatment systems would be required for all Phase 1A, 2, and 3 potable water supply wells servicing the Project area. The County will need to perform routine water sampling from areas throughout the Project site to determine exactly which contaminants are present in the underground aquifers along with their associated concentrations. Capital and operations and maintenance (O&M) costs for wellhead treatment systems are discussed in Chapter 6.

For all supply alternatives, non-potable water may be utilized for irrigation and fire protection purposes. Use of non-potable water for these purposes will significantly reduce costs for water treatment normally required for drinking water standards.

#### 3.3.1 Groundwater Supply Alternatives for Consideration in the Environmental Impact Report

The proposed project requires water supplies for both potable and non-potable water demands. Estimates of these demands are developed in Section 4.0. Stanislaus County commissioned a separate study for updated concepts for water supply that consider the impacts and implications of California Senate Bill (SB) 1263. Under SB 1263, any new drinking water system seeking a permit from the State Water Resources Control Board’s Division of Drinking Water (DDW) must conduct a meaningful dialogue with all existing systems within three miles of any portion of the respective water service areas to evaluate the feasibility of consolidation, annexation, or extension of water services. The CLIBP is within

**CROWS LANDING INDUSTRIAL BUSINESS PARK  
WATER SUPPLY (POTABLE & NON-POTABLE) INFRASTRUCTURE AND FACILITIES STUDY  
FEBRUARY 27, 2015 (UPDATED JANUARY 11, 2018)**

three miles of both the COP and CLCSD water systems. Preliminary discussions have been held by Stanislaus County with both systems' engineering and administrative staff to assess viable alternatives to extend their respective service areas to include the CLIBP. The full memo report is included in Appendix C.

The three water supply alternatives to the considered are:

- Option 1: extension of the CLCSD service area to the CLIP to cooperatively supply water and system improvements under the existing drinking water supply permit.
- Option 2: the County performs all steps necessary to obtain a new permit to provide drinking water to the CLIBP including the required evaluations with nearby systems.
- Option 3: the COP's water service area is extended to include the CLIBP under its existing drinking water supply permit.

The infrastructure requirements for these three alternatives are discussed in Section 6.0. All three alternatives are presented for consideration in the EIR.

CROWS LANDING INDUSTRIAL BUSINESS PARK  
WATER SUPPLY (POTABLE & NON-POTABLE) INFRASTRUCTURE AND FACILITIES STUDY  
FEBRUARY 27, 2015 (UPDATED JANUARY 11, 2018)

## 4.0 PROPOSED DEMAND

Section 4 presents an overview of the proposed land uses and water demand projections for the Project.

### 4.1 PROPOSED LAND USE

The Project proposes to develop the 1,528-acre site from its current land use into a business park with primarily industrial land uses. This study assumes that 1,274 acres of the Project will be developable and of the 1,274 developable acres, 1,274 acres will require potable and non-potable water service. Figure 1.1 shows the phasing plan for the Project based on the Crows Landing Industrial Business Park. The Project area designated in Figure 1.1 as Phase 1A (Fink Road Corridor) will be developed first during Phase 1.

### 4.2 POTABLE WATER AND NON-POTABLE WATER DEMAND PROJECTIONS

Water demand projections developed for this study are based on the total acreages of developable areas within the limits of the Project and a total water demand rate of 2,500 gallons per day per acre (gpd/ac) per direction of the Stanislaus County Department of Public Works (SCDPW). This demand rate is based on typical values published in the *Water Distribution System Handbook* for industrial and commercial land uses, and a comparison of local agency planning demand values. This demand rate is slightly higher than the City of Modesto's demand unit water use factor of 2.75 af/ac/yr for industrial land use designations, which is equivalent to 2,455 gallons per day per acre. (COM 2014) Potable water demands to meet domestic needs are estimated by the SCDPW to be 60% of the total water demand and non-potable water demands for fire protection and irrigation uses are estimated to be, on average, 40% of the total water demand. Actual irrigation demand will vary seasonally, with much higher demands in the summer dry season, and low to none during winter wet season. These projections are based on land use acreage rather than population projections, which will account for expected potable water for domestic use and non-potable water for irrigation and fire flow use within the Project. Development of the demand projections is achieved by multiplying unit water use factors for each land use category, based on typical average water duty values and peaking factors, by the acreage for each land use area. The land use-based projection methodology applies for all land uses except the airport and multimodal trails. The airport and multimodal land uses were deemed to use significantly less water than the other land uses and, therefore, an alternative approach was considered for each. Potable airport water demands were calculated based on the sewer loading factor stated in Table 3-2 of the textbook entitled *Wastewater Engineering Treatment and Reuse*, which states that a person in an airport generates approximately 5 gallons of sewage per day.<sup>1</sup> A potable water demand can be derived from this sewer loading factor by assuming a return-to-sewer percentage. It has been shown that approximately 90 percent of per-capita water used is returned to the sewer<sup>2</sup>. Using the return-to-sewer percentage, the sewer loading factor can be used to estimate water demand by dividing the sewer

---

<sup>1</sup> Tchobanoglous, et. al. *Wastewater Engineering Treatment and Reuse*, 4<sup>th</sup> Edition, McGraw-Hill, New York, New York, 2003. page 157.

<sup>2</sup> Tchobanoglous, et. al. *Wastewater Engineering Treatment and Reuse*, 4<sup>th</sup> Edition, McGraw-Hill, New York, New York, 2003. page 155.

**CROWS LANDING INDUSTRIAL BUSINESS PARK  
WATER SUPPLY (POTABLE & NON-POTABLE) INFRASTRUCTURE AND FACILITIES STUDY  
FEBRUARY 27, 2015 (UPDATED JANUARY 11, 2018)**

loading factor by the return-to-sewer percentage (5 gallons per capita per day/0.9 = 5.6 gallons per capita per day). The County anticipates that approximately 100 people will utilize the airport/multimodal facilities per day. Assuming 100 people per day and 5.6 gallons per person per day yields a calculated average day demand of approximately 0.39 gallons per minute for the airport/multimodal land uses. The non-potable airport demand was calculated using the Simplified Landscape Irrigation Demand Estimation (SLIDE) methodology. The airport is approximately 370 acres in size, of which approximately 297 acres will be covered in runway. The remaining 75 acres will be unpaved and assumed to be landscaped. The SLIDE method calculates annual water demand by adjusting reference evapotranspiration by specified plant factors using the following formula:

$$\text{Water Demand (gallons per year)} = \sum_{1}^{n} ((ET_{O} \times PF_{n}) \times LA_{n}) \times 0.623$$

Where:

ET<sub>O</sub> = Reference Evapotranspiration (inches)

PF = Plant Factor (unitless)

LA = Landscaped Area (square feet)

0.623 = conversion factor

For this study, it is assumed that all irrigated areas in the airport will be planted with trees, shrubs, groundcovers, and vines and have a plant factor of 0.5<sup>3</sup>. In addition to irrigation demand, the aviation/multimodal non-potable demand also includes an estimate of non-potable water to be utilized at the airplane wash rack areas. Landscaping will be drought tolerant and subject to local water drought and conservation policies (Stanislaus County Code Title 21.102 Landscape and Irrigation Standards) and the Model Water Efficient Landscape Ordinance (MWELO).

Potable water demand projections are calculated for Average Day Demand (ADD), Maximum Day Demand (MDD), and Peak Hour Demand (PHD). ADDs are representative of the total annual quantity of water production for an agency or municipality, divided by 365; these values are typically determined based on an average day unit demand as determined by the governing agency. MDDs are representative of the highest water demand of the year during any 24-hour period. PHDs are representative of the highest water demand of the year during any 1-hour period. Water projections for fire flow demands typically range from 1,500 gallons per minute (GPM) to 8,000 GPM, depending on the type of land use.

#### 4.3 FIRE FLOW REQUIREMENTS

The system must be adequately sized to provide the required fire flows for the specified duration in accordance with the California Fire Code (CFC) and any other local agency criteria. Numerous factors

---

<sup>3</sup> Published on the Division of Agriculture and Natural Sciences, University of California website ([http://ucanr.edu/sites/UrbanHort/Water\\_Use\\_of\\_Turfgrass\\_and\\_Landscape\\_Plant\\_Materials/SLIDE\\_\\_Simplified\\_Irrigation\\_Demand\\_Estimation/](http://ucanr.edu/sites/UrbanHort/Water_Use_of_Turfgrass_and_Landscape_Plant_Materials/SLIDE__Simplified_Irrigation_Demand_Estimation/)) accessed on 2/8/2016.

**CROWS LANDING INDUSTRIAL BUSINESS PARK  
 WATER SUPPLY (POTABLE & NON-POTABLE) INFRASTRUCTURE AND FACILITIES STUDY  
 FEBRUARY 27, 2015 (UPDATED JANUARY 11, 2018)**

may impact fire flow requirements, such as building size, type of construction, use of automatic sprinkler systems, number of stories, exposure, etc. For the purposes of this study, because the Project land use is predominantly industrial, the modeling analysis assumes a single fire flow requirement of 3,000 GPM for a 4-hour duration.

This fire flow and duration assumes that buildings are equipped with automatic sprinkler systems per the California Fire Code (CFC), Title 24, Part 9, Appendix B. The CFC allows for a reduction of required fire flow of up to 75% if buildings are provided with approved automatic sprinkler systems. The largest fire flow required by the CFC is 8,000 gpm for 4 hours. The application of the 75% reduction factor to 8,000 gpm requires a fire flow of 2,000 gpm for 4 hours. The County has indicated that all new construction related to the Project will have a fire sprinkler systems and therefore should be eligible for a required fire flow reduction of 75%. This master plan uses a fire flow demand of 3,000 gpm to plan for potential changes to the fire flow requirements when the project develops. Residual pressures during fire flow conditions are to be maintained at no less than 20 pounds per square inch (psi) at the most remote junction node in the system. The most restrictive condition may not necessarily be at the service location. Any required fire flows in addition to those indicated in Table 4.1 will be provided by individual developments through additional on-site storage or through other mitigation measures. Typical fire flows/durations for the Project land use categories are listed in Table 4.1.

**Table 4.1 – Required Fire Flows**

Use Category	Required Fire Flow (GPM)	Duration (Hours)
Industrial/Business Park	3,000	4

**4.4 PEAKING FACTORS AND SUPPLY REQUIREMENTS**

MDD projections are used to determine the Project’s overall supply requirements and the capacity of supply components. PHD projections and MDD with fire flow projections are typically used in the sizing of pipelines, storage, and pumping facilities. City of Patterson MDD and PHD to ADD peaking factors of 2 and 4, respectively, are assumed for all land uses. This is considered a conservative assumption, as the City of Modesto utilizes lower peaking factors of 1.75 and 2.46 for MDD and PHD, respectively. (COM 2014) The proposed water supply system must be capable of conveying MDD, which will be met by water supply facilities. Storage facilities will provide equalization storage during ADD to provide water supply during higher demand periods such as PHD, as further discussed in Section 5.3.

**4.4.1 Potable Water Buildout ADD, MDD, and PHD Projections**

Projected ADD, MDD, and PHD for the Project are 1.34 million gallons per day (MGD), 2.67 MGD, and 5.35 MGD, respectively, as shown in Table 4.2. Actual demands may vary somewhat from initial projections, based on numerous factors, such as different types of industry, density, employees per acre, conservation, etc.

**CROWS LANDING INDUSTRIAL BUSINESS PARK  
WATER SUPPLY (POTABLE & NON-POTABLE) INFRASTRUCTURE AND FACILITIES STUDY  
FEBRUARY 27, 2015 (UPDATED JANUARY 11, 2018)**

**Table 4.2 – Projected Buildout Potable Water Demand**

Land Use	Acreage	Estimated Daily Visitors	Avg. Day Unit Demand <sup>1,2</sup> (GPCD or GAL/ACRE/DAY)	Avg. Day Potable Demand <sup>3</sup> (GAL/ACRE/DAY)	Demand (MGD)		
					Avg. Day	Max Day <sup>4</sup>	Peak Hour <sup>4</sup>
Aviation/Multimodal	383	100	5.6	5.6	0.0006	0.0011	0.0022
Aviation Related	46	-	2,500	1,500	0.07	0.14	0.28
Logistics/Distribution	349	-	2,500	1,500	0.52	1.05	2.09
Industrial	350	-	2,500	1,500	0.53	1.05	2.10
Business Park	78	-	2,500	1,500	0.12	0.23	0.47
Public Facilities	68	-	2,500	1,500	0.10	0.20	0.41
<b>Total</b>	<b>1,274</b>				<b>1.34</b>	<b>2.67</b>	<b>5.35</b>

**Notes:**  
<sup>1</sup>Unit demand values are based on direction of the Stanislaus County Department of Public Works and typical published values published in the Water Distribution System Handbook, Larry W. Mays, The McGraw-Hill Companies, Inc. Copyright 2000, Table 3.2 Typical Water Duties  
<sup>2</sup>Unit Demand is calculated estimated from typical sewer loading for aviation land use. Factor is calculated on the assumption that 90% of water becomes sewage (5/0.9 = 5.6)  
<sup>3</sup>Non -aviation/multimodal unit demands based on potable water accounting for 60% of unit demand  
<sup>4</sup>The ratio of average day demand to maximum day demand is estimated at 1:2.0. The ratio of average day demand to peak hour demand is estimated to be 1:4.0.

4.4.1.1 Potable Water Phase 1 ADD, MDD, and PHD Projections

Projected Phase 1 ADD, MDD, and PHD for the Project are 0.59 MGD, 1.18 MGD, and 2.37 MGD, respectively, as shown in Table 4.3.

**Table 4.3 – Projected Phase 1 Potable Water Demand**

Land Use	Acreage	Estimated Daily Visitors	Avg. Day Unit Demand <sup>1,2</sup> (GAL/ACRE/DAY)	Avg. Day Potable Demand <sup>3</sup> (GAL/ACRE/DAY)	Demand (MGD)		
					Avg. Day	Max Day <sup>3</sup>	Peak Hour <sup>3</sup>
<b>Phase 1A</b>							
Logistics/Distribution	52	-	2,500	1,500	0.078	0.156	0.312
Industrial	41	-	2,500	1,500	0.0615	0.123	0.246
Business Park	10	-	2,500	1,500	0.015	0.03	0.06
<b>Subtotal</b>	<b>103</b>				<b>0.15</b>	<b>0.31</b>	<b>0.62</b>
<b>Phase 1B</b>							
Logistics/Distribution	138	-	2,500	1,500	0.21	0.41	0.83
Industrial	110	-	2,500	1,500	0.17	0.33	0.66
Business Park	28	-	2,500	1,500	0.04	0.08	0.17
<b>Airport - Phase 1 Infrastructure</b>	<b>370</b>	<b>100</b>	<b>5.6</b>	<b>5.6</b>	<b>0.0006</b>	<b>0.0011</b>	<b>0.0022</b>
Public Facilities	15	-	2,500	1,500	0.02	0.05	0.09
<b>Subtotal</b>	<b>661</b>				<b>0.44</b>	<b>0.87</b>	<b>1.75</b>
<b>Total</b>	<b>764</b>				<b>0.59</b>	<b>1.18</b>	<b>2.37</b>

**Notes:**  
<sup>1</sup>Unit demand values are based on direction of the Stanislaus County Department of Public Works and typical published values published in the Water Distribution System Handbook, Larry W. Mays, The McGraw-Hill Companies, Inc. Copyright 2000, Table 3.2 Typical Water Duties  
<sup>2</sup>Unit Demand is calculated estimated from typical sewer loading for aviation land use. Factor is calculated on the assumption that 90% of water becomes sewage (5/0.9 = 5.6), Tchobanoglous, et. al. Wastewater Engineering Treatment and Reuse, 4th Edition, McGraw-Hill, New York, New York, 2003.  
<sup>3</sup>Non -aviation/multimodal unit demands based on potable water accounting for 60% of unit demand  
<sup>4</sup>The ratio of average day demand to maximum day demand is estimated at 1:2.0. The ratio of average day demand to peak hour demand is estimated to be 1:4.0.

**CROWS LANDING INDUSTRIAL BUSINESS PARK  
WATER SUPPLY (POTABLE & NON-POTABLE) INFRASTRUCTURE AND FACILITIES STUDY  
FEBRUARY 27, 2015 (UPDATED JANUARY 11, 2018)**

4.4.1.2 Potable Water Phase 2 ADD, MDD, and PHD Projections

Projected Phase 2 ADD, MDD, and PHD for the Project are 0.35 MGD, 0.71 MGD, and 1.42 MGD, respectively, as shown in Table 4.4.

**Table 4.4 – Projected Phase 2 Potable Water Demand**

Land Use	Acreage	Avg. Day Unit Demand <sup>1</sup>	Avg. Day Potable Demand <sup>2</sup>	Demand (MGD)		
				Avg. Day	Max Day <sup>3</sup>	Peak Hour <sup>3</sup>
<b>SR 33 Corridor South</b>						
Logistics/Distribution	57	2,500	1,500	0.09	0.17	0.34
Industrial	71	2,500	1,500	0.11	0.21	0.43
Business Park	14	2,500	1,500	0.02	0.04	0.08
<b>Aviation-Related Use</b>	46	2,500	1,500	0.07	0.14	0.28
<b>Multimodal Transportation</b>	13	2,500	1,500	0.02	0.04	0.08
<b>Public Facilities</b>	35	2,500	1,500	0.05	0.11	0.21
<b>Total</b>	<b>236</b>			<b>0.35</b>	<b>0.71</b>	<b>1.42</b>
<b>Notes:</b>						
<sup>1</sup> Unit demand values are based on direction of the Stanislaus County Department of Public Works and typical values published in the Water Distribution System Handbook, Larry W. Mays, The McGraw-Hill Companies, Inc. Copyright 2000, Table 3.2 Typical Water Duties						
<sup>2</sup> Based on Potable Water accounting for 60% of Unit Demand						
<sup>3</sup> The ratio of average day demand to maximum day demand is estimated at 1:2.0. The ratio of average day demand to peak hour demand is estimated to be 1:4.0.						

4.4.1.3 Potable Water Phase 3 ADD, MDD, and PHD Projections

Projected Phase 3 ADD, MDD, and PHD for the Project are 0.41 MGD, 0.82 MGD, and 1.64 MGD, respectively, as shown in Table 4.5.

**Table 4.5 - Projected Phase 3 Potable Water Demand**

Land Use	Acreage	Avg. Day Unit Demand <sup>1</sup>	Avg. Day Potable Demand <sup>2</sup>	Demand (MGD)		
				Avg. Day	Max Day <sup>3</sup>	Peak Hour <sup>3</sup>
<b>SR 33 Corridor North</b>						
Logistics/Distribution	102	2,500	1,500	0.15	0.31	0.61
Industrial	128	2,500	1,500	0.19	0.38	0.77
Business Park	26	2,500	1,500	0.04	0.08	0.16
<b>Public Facilities</b>	18	2,500	1,500	0.03	0.05	0.11
<b>Total</b>	<b>274</b>			<b>0.41</b>	<b>0.82</b>	<b>1.64</b>
<b>Notes:</b>						
<sup>1</sup> Unit demand values are based on direction of the Stanislaus County Department of Public Works and typical values published in the Water Distribution System Handbook, Larry W. Mays, The McGraw-Hill Companies, Inc. Copyright 2000, Table 3.2 Typical Water Duties						
<sup>2</sup> Based on Potable Water accounting for 60% of Unit Demand						
<sup>3</sup> The ratio of average day demand to maximum day demand is estimated at 1:2.0. The ratio of average day demand to peak hour demand is estimated to be 1:4.0.						

4.4.2 Non-Potable Water Irrigation + Fire Flow Projection

The projected average daily irrigation demand for the Project is 1.18 million gallons per day (MGD) as shown in Table 4.6. Fire flow demands will be serviced by the non-potable system via a non-potable storage tank and are considered separate from the irrigation demands. Actual demands may vary somewhat from initial projections, based on numerous factors, such as different types of industry, density, employees per acre, conservation, etc. The fire flow volume for all areas of the Project will be

**CROWS LANDING INDUSTRIAL BUSINESS PARK  
WATER SUPPLY (POTABLE & NON-POTABLE) INFRASTRUCTURE AND FACILITIES STUDY  
FEBRUARY 27, 2015 (UPDATED JANUARY 11, 2018)**

satisfied by the non-potable water storage tank to be provided in Phase 1. The projected irrigation demands for Phases 1, 2, and 3 are shown in tables 4.7, 4.8, and 4.9, respectively.

**Table 4.6 – Projected Buildout Non-Potable Water Irrigation Demand**

Land Use	Acreage <sup>7</sup>	Plant Factor	Flights Per Week	Avg. Day Unit Demand <sup>1</sup> (GAL/ACRE/DAY)	Avg. Day Nonpotable Demand <sup>2</sup> (GAL/ACRE/DAY)	Demand (MGD)	
						Avg. Day	Max Day <sup>5</sup>
Aviation Wash Rack <sup>3</sup>	-	-	20	-	-	0.00058	0.00115
Aviation Landscape <sup>4</sup>	75	0.5	-	-	-	0.29	0.58
Aviation Related	46	-	-	2,500	1,000	0.05	0.09
Multimodal Transportation	13	-	-	2,500	1,000	0.01	0.03
Logistics/Distribution	349	-	-	2,500	1,000	0.35	0.70
Industrial	350	-	-	2,500	1,000	0.35	0.70
Business Park	78	-	-	2,500	1,000	0.08	0.16
Public Facilities	68	-	-	2,500	1,000	0.07	0.14
<b>Total</b>	<b>979</b>					<b>1.20</b>	<b>2.39</b>

**Notes:**

<sup>1</sup>Unit demand values are based on direction of the Stanislaus County Department of Public Works and typical published values in the Water Distribution System Handbook, Larry W. Mays, The McGraw-Hill Companies, Inc. Copyright 2000, Table 3.2 Typical Water Duties

<sup>2</sup>Based on Potable Water accounting for 40% of Unit Demand

<sup>3</sup>Demand estimated to be approximately 208,000 gallons/year. Calculated as 20 washes/week x 52 weeks/year x 20 gallons/minute x 10 minutes/wash. 20 gallons/ minute is based on wash rack manufactured by Hydro Engineering (<http://www.hydroblaster.com/InstantAircraftWashRack.htm>) accessed 2/8/16.

<sup>4</sup>Demand is estimated by using SLIDE methodology which applies a plant factor to the area reference ET<sub>0</sub>. ET<sub>0</sub> is estimated to be 58.41 inches per year for the CLIBP area.

[http://ucanr.edu/sites/UrbanHort/Water\\_Use\\_of\\_Turfgrass\\_and\\_Landscape\\_Plant\\_Materials/SLIDE\\_Simplified\\_Irrigation\\_Demand\\_Estimation/](http://ucanr.edu/sites/UrbanHort/Water_Use_of_Turfgrass_and_Landscape_Plant_Materials/SLIDE_Simplified_Irrigation_Demand_Estimation/)

<sup>5</sup>Maximum day demand is equal to 2 times the nonpotable water average day demand.

<sup>6</sup>Fire flow demand is 3,000 gpm for a duration of 4 hours. This demand is not considered part of the average day non-potable water irrigation demand as it will be accounted for by the planned storage tanks

<sup>7</sup>This area is representative of the area planned to receive nonpotable water. The remaining 295 acres is runways which do not require water. (966+295 = 1,261)



**CROWS LANDING INDUSTRIAL BUSINESS PARK  
WATER SUPPLY (POTABLE & NON-POTABLE) INFRASTRUCTURE AND FACILITIES STUDY  
FEBRUARY 27, 2015 (UPDATED JANUARY 11, 2018)**

**Table 4.7 – Projected Phase 1 Non-Potable Water Irrigation and Fire Flow Demand**

Land Use	Acreage <sup>7</sup>	Plant Factor	Flights Per Week	Avg. Day Unit Demand <sup>1</sup> (GAL/ACRE/DAY)	Avg. Day Nonpotable Demand <sup>2</sup> (GAL/ACRE/DAY)	Demand (MGD)	
						Avg. Day	Max Day <sup>5</sup>
<b>Phase 1A</b>							
Logistics/Distribution	52	-	-	2,500	1,000	0.05	0.104
Industrial	41	-	-	2,500	1,000	0.04	0.082
Business Park	10	-	-	2,500	1,000	0.01	0.02
<b>Subtotal</b>	<b>103</b>					<b>0.103</b>	<b>0.206</b>
<b>Phase 1B</b>							
Logistics/Distribution	138	-	-	2,500	1,000	0.14	0.276
Industrial	110	-	-	2,500	1,000	0.11	0.22
Business Park	28	-	-	2,500	1,000	0.03	0.056
Aviation Wash Rack <sup>3</sup>	-	-	20	-	-	0.0006	0.00116
Aviation Landscape <sup>4</sup>	75	0.5	-	-	-	0.29	0.58
Public Facilities	15			2,500	1,000	0.02	0.03
<b>Subtotal</b>	<b>366</b>					<b>0.582</b>	<b>1.163</b>
<b>Total</b>	<b>469</b>					<b>0.68</b>	<b>1.37</b>
<b>Notes:</b>							
<sup>1</sup> Unit demand values are based on direction of the Stanislaus County Department of Public Works and typical published values in the Water Distribution System Handbook, Larry W. Mays, The McGraw-Hill Companies, Inc. Copyright 2000, Table 3.2 Typical Water Duties							
<sup>2</sup> Based on Potable Water accounting for 40% of Unit Demand							
<sup>3</sup> Demand estimated to be approximately 208,000 gallons/year. Calculated as 20 washes/week x 52 weeks/year x 20 gallons/minute x 10 minutes/wash. 20 gallons/minute is based on wash rack manufactured by Hydro Engineering ( <a href="http://www.hydroblaster.com/InstantAircraftWashRack.htm">http://www.hydroblaster.com/InstantAircraftWashRack.htm</a> ) accessed 2/8/16.							
<sup>4</sup> Demand is estimated by using SLIDE methodology which applies a plant factor to the area reference ET <sub>o</sub> . ET <sub>o</sub> is estimated to be 58.41 inches per year for the CLIBP area. <a href="http://ucanr.edu/sites/UrbanHort/Water_Use_of_Turfgrass_and_Landscape_Plant_Materials/SLIDE_Simplified_Irrigation_Demand_Estimation/">http://ucanr.edu/sites/UrbanHort/Water_Use_of_Turfgrass_and_Landscape_Plant_Materials/SLIDE_Simplified_Irrigation_Demand_Estimation/</a>							
<sup>5</sup> Maximum day demand is equal to 2 times the nonpotable water average day demand.							
<sup>6</sup> Fire flow demand is 3,000 gpm for a duration of 4 hours. This demand is not considered part of the average day non-potable water irrigation demand as it will be accounted for by the planned storage tanks							
<sup>7</sup> This area is representative of the area planned to receive nonpotable water.							

**Table 4.8 – Projected Phase 2 Non-Potable Water Irrigation and Fire Flow Demand**

Land Use	Acreage	Avg. Day Unit Demand <sup>1</sup> (GAL/ACRE/DAY)	Avg. Day Nonpotable Demand <sup>2</sup>	Demand (MGD)	
				Avg. Day	Demand (MGD) Max Day <sup>3</sup>
<b>SR 33 Corridor South</b>					
Logistics/Distribution	57	2,500	1,000	0.06	0.114
Industrial	71	2,500	1,000	0.07	0.142
Business Park	14	2,500	1,000	0.01	0.028
<b>Aviation Related</b>	46	2,500	1,000	0.05	0.092
<b>Multimodal Transportation</b>	13	2,500	1,000	0.01	0.026
<b>Public Facilities</b>	35	2,500	1,000	0.04	0.07
<b>Total</b>	<b>236</b>			<b>0.24</b>	<b>0.47</b>
<b>Notes:</b>					
<sup>1</sup> Unit demand values are based on direction of the Stanislaus County Department of Public Works and typical published values in the Water Distribution System Handbook, Larry W. Mays, The McGraw-Hill Companies, Inc. Copyright 2000, Table 3.2 Typical Water Duties					
<sup>2</sup> Based on Potable Water accounting for 40% of Unit Demand					
<sup>3</sup> Maximum day demand is equal to 2 times the nonpotable water average day demand.					
<sup>4</sup> Fire flow demand is 3,000 gpm for a duration of 4 hours. This demand is not considered part of the average day non-potable water irrigation demand as it will be accounted for by the planned storage tanks					

**CROWS LANDING INDUSTRIAL BUSINESS PARK  
 WATER SUPPLY (POTABLE & NON-POTABLE) INFRASTRUCTURE AND FACILITIES STUDY  
 FEBRUARY 27, 2015 (UPDATED JANUARY 11, 2018)**

**Table 4.9 - Projected Phase 3 Non-Potable Water Irrigation Demand**

Land Use	Acreage	Avg. Day Unit Demand <sup>1</sup> (GAL/ACRE/DAY)	Avg. Day Nonpotable Demand <sup>2</sup>	Demand (MGD) Avg. Day	Demand (MGD) Max Day <sup>3</sup>
<b>SR 33 Corridor North</b>					
Logistics/Distribution	102	2,500	1,000	0.10	0.204
Industrial	128	2,500	1,000	0.13	0.256
Business Park	26	2,500	1,000	0.03	0.052
<b>Public Facilities</b>	18	2,500	1,000	0.02	0.036
<b>Total</b>	<b>274</b>			<b>0.27</b>	<b>0.55</b>

**Notes:**

<sup>1</sup>Unit demand values are based on direction of the Stanislaus County Department of Public Works and typical published values in the Water Distribution System Handbook, Larry W. Mays, The McGraw-Hill Companies, Inc. Copyright 2000, Table 3.2 Typical Water Duties

<sup>2</sup>Based on Potable Water accounting for 40% of Unit Demand

<sup>3</sup>Maximum day demand is equal to 2 times the nonpotable water average day demand.

<sup>4</sup>Fire flow demand is 3,000 gpm for a duration of 4 hours. This demand is not considered part of the average day non-potable water irrigation demand as it will be accounted for by the planned storage tanks

## 5.0 SYSTEM OPERATING CRITERIA

Section 5 discusses system operating criteria for the Project.

### 5.1 TRANSMISSION / DISTRIBUTION DESIGN CRITERIA

Hydraulic modeling criteria for backbone distribution and transmission mains are typically established to keep velocities and head losses per thousand lineal feet within acceptable ranges. The potable water system must also be capable of meeting domestic demands at adequate service pressures. The non-potable water system must deliver the required irrigation demands and fire flow demands to all regions of the system.

The service velocity and criteria used in this analysis are consistent with the typical values used in general engineering practice. The minimum and maximum pressure requirements for system service criteria used for this study are shown in Table 5.1.

**Table 5.1 – System Service Criteria**

Demand Scenario	Minimum Pressure (psi)	Maximum Pressure (psi)
Potable Water: Average Day Demand	40	120
Potable Water: Maximum Day Demand	40	120
Potable Water: Peak Hour Demand	30	120
Non-Potable Water: Irrigation Demand plus Fire Flow Demand	20	120

The maximum fluid velocity criteria used in the evaluation of large distribution mains (16-inch-diameter pipe and greater) and standard distribution mains (pipe diameter less than 16 inches) is shown in Table 5.2 in feet per second (fps).

**Table 5.2 – Water Main Velocity Criteria**

Demand Scenario	Maximum Velocity (fps)	
	Large Main	Standard Main
Average Day Demand	3	5
Maximum Day Demand	5	5
Peak Hour Demand	8	8
Irrigation Demand plus Fire Flow	10	10

**CROWS LANDING INDUSTRIAL BUSINESS PARK  
WATER SUPPLY (POTABLE & NON-POTABLE) INFRASTRUCTURE AND FACILITIES STUDY  
FEBRUARY 27, 2015 (UPDATED JANUARY 11, 2018)**

**5.2 TANK AND BOOSTER PUMP STATION SIZING CRITERIA**

Storage tanks serve as equalization measures to meet variable water demands and are typically sized to meet peak operational needs as well as emergency needs and fire flows. Fluctuations in water usage rates can be met by continuously varying source production, by continuously varying pumping rates, or by filling and draining storage tanks. The process of filling and draining storage tanks is much easier operationally and is generally less expensive than the other methods. Facilities serving portions of a distribution system with storage tanks generally need to be sized only to meet maximum daily demands, with the storage tanks providing additional water during instantaneous peak demands. Typically, the volumetric difference between peak demands and the available supply is retained in above-ground tanks as a practical method to meet operational fluctuations in demands and to maintain reasonably sized mains and to comply with California Code of Regulations (CCR) Title 22 requirements. Potable water storage requirements are shown in Table 5.3.

**Table 5.3 – Potable Water Storage Requirements**

<b>Component</b>	<b>Storage Volume</b>
Potable Water: Operation	25% of MDD
Potable Water: Emergency	150% of ADD
Non-Potable Water Fire Flow	Fire Flow x Duration

Booster pump stations will need to be sized to meet the higher requirements of irrigation demand plus fire flow demand, and/or PHD, as required for each facility.

**5.3 TANK / BOOSTER PUMP STATIONS**

Section 6 discusses the sizing of storage tanks and booster pump stations.

**5.3.1 Tank and Booster Pump Stations**

The Project will need to meet its own potable water and non-potable water storage requirements at buildout.

**5.3.2 Buildout Storage and Pumping Requirements**

Water storage tanks and a booster pumping facility will be needed to serve the Project and will be sized as shown in Table 5.4.

**CROWS LANDING INDUSTRIAL BUSINESS PARK  
WATER SUPPLY (POTABLE & NON-POTABLE) INFRASTRUCTURE AND FACILITIES STUDY  
FEBRUARY 27, 2015 (UPDATED JANUARY 11, 2018)**

**Table 5.4 – Buildout Water Storage Requirements**

<b>Component</b>	<b>Phase 1A Storage (MG)</b>	<b>Phase 1+2 Storage (MG)</b>	<b>Buildout Storage (MG)</b>
Potable Water: Operation (0.25*MDD)	0.30	0.68	0.68
Potable Water: Emergency (1.25*ADD)	0.89	2.03	2.03
Potable Water Total	1.19	2.71	2.71
<hr/>			
Non-Potable Water: Fire (3,000 gpm for 4 hours)	0.72	0.72	0.72
Non-Potable Water Total	0.72	0.72	0.72

Based on the storage requirements, it is estimated that a total of 3 water storage tanks (2 potable water and 1 non-potable water) are required for the Project. The buildout of the Project requires approximately 2.71 MG potable water storage and 0.72 MG non-potable water storage.

The non-potable water booster pump station at the non-potable water storage tank site will need to meet the irrigation demand and 3,000 GPM fire flow demand.

**5.3.2.1 Phase 1A Storage and Pumping Requirements**

The initial phase of the Project shall provide one potable water tank with a 1.19-MG capacity and a non-potable tank with a 0.72-MG capacity and a non-potable water booster pump station with capacity to meet the required fire flow demand. This infrastructure is shown in Figure 7.1 at the end of this report.

Phase 1A, Option 1

This alternative described in Appendix C includes combining the needs of the CLCSD and CLIBP to one water system. Phase 1A infrastructure is shown in Figure A2 in Appendix C. Components include the 1.19 MG potable water storage tank and water treatment system at the corner of Bell and Fink Roads, and the 0.72 MG non-potable water tank. Two new wells would be installed at the CLIBP, and supply water to both the potable and non-potable water tanks. Additional water supply would come from two existing wells at the CLCSD and conveyed through a water supply pipeline along Fink Road. This alternative allows for blending water supplies from both CLCSD and CLIBP, potentially eliminating the need for additional treatment.

Phase 1A, Option 2

This alternative includes supplying all water needs from the CLIBP. Phase 1A infrastructure is shown in Figure B2 in Appendix C. Components include two new wells that supply water to both the potable and non-potable water tanks and a water treatment system.

Phase 1A, Option 3

This alternative has the same infrastructure as Option 2, with the exception of an intertie to COP that occurs in Phase 2.

**CROWS LANDING INDUSTRIAL BUSINESS PARK  
WATER SUPPLY (POTABLE & NON-POTABLE) INFRASTRUCTURE AND FACILITIES STUDY  
FEBRUARY 27, 2015 (UPDATED JANUARY 11, 2018)**

**5.3.2.2 Phase 2 Storage Requirements**

An additional potable water tank with a 1.52-MG capacity shall be provided as part of Phase 2 of the Project. The addition of this second tank will increase the potable water storage capacity to 2.71 MG. The required non-potable water storage is provided by the tank installed in the initial phase of the Project. This infrastructure is shown in Figure 7.2 at the end of this report.

Phase 2, Option 1

This alternative described in Appendix C includes additional Phase 2 infrastructure as shown in Figure A2 in Appendix C. Components include the additional 1.52 MG potable water storage tank and two new wells at the CLIBP, supplying water to both the potable and non-potable water tanks.

Phase 2, Option 2

This alternative includes construction of the same additional Phase 2 infrastructure as Alternative A.

Phase 2, Option 3

This alternative has the same infrastructure as Option 2, plus the intertie pipeline to COP that is constructed in Phase 2.

**5.3.2.3 Phase 3 Storage Requirements**

The potable water storage requirements were accounted for in the sizing of the potable water storage tank that in Phase 2. This infrastructure is shown in Figure 7.3 at the end of this report.

Phase 3, Alternatives A, B and C

Additional infrastructure for these alternatives is shown in Appendix C in Figures A3, B3 and C3, respectively. No additional wells or storage tanks are constructed in Phase 3.

**CROWS LANDING INDUSTRIAL BUSINESS PARK  
WATER SUPPLY (POTABLE & NON-POTABLE) INFRASTRUCTURE AND FACILITIES STUDY  
FEBRUARY 27, 2015 (UPDATED JANUARY 11, 2018)**

**6.0 POTABLE AND NON-POTABLE WATER INFRASTRUCTURE**

Based on criteria and demands discussed in Sections 4 and 5, a preliminary design can be determined for the project site. This section discusses the preliminary design and provides preliminary costs.

**6.1 PROPOSED ON-SITE POTABLE WATER INFRASTRUCTURE**

Development of Phase 1 proposes construction of backbone infrastructure to provide potable water service to the airport, the Phase 1 area immediately south of the airport, and 15 acres of Public Facilities. Potable water infrastructure required as part of Phase 1 improvements includes distribution piping, valves, a potable water storage tank (1.2 MG) east of the intersection of Davis Road and Fink Road, and a water well and booster pump station located adjacent to the potable water storage tank. Estimated construction costs for the Phase 1 potable water system construction are provided in Table 6.1.

**Table 6.1 Estimated Phase 1 Onsite Potable Water System Construction Costs**

Description	Quantity	Unit	Unit Price	Cost
<b>Phase 1A</b>				
12-Inch PVC	4,240	LF	\$ 65.00	\$ 275,600.00
12-Inch Gate Valve	4	EA	\$ 1,000.00	\$ 4,000.00
Water Well and Booster Pump Station	1	EA	\$ 2,500,000.00	\$ 2,500,000.00
Potable Water Storage Tank (1.4 MG)	1	EA	\$ 2,550,000.00	\$ 2,550,000.00
Wellhead Treatment System <sup>1</sup>	1	LS	\$ 2,150,000.00	\$ 2,150,000.00
<b>Subtotal</b>				<b>\$ 7,479,600.00</b>
<b>Phase 1B</b>				
12-Inch PVC	34,460	LF	\$ 65.00	\$ 2,239,900.00
12-Inch Gate Valve	34	EA	\$ 1,000.00	\$ 34,000.00
<b>Subtotal</b>				<b>\$ 2,273,900.00</b>
Subtotal of Phase 1				\$ 9,753,500.00
Engineering Costs (20%)				\$ 1,951,000.00
Contingencies (20%)				\$ 2,341,000.00
<b>Total Estimated Opinion of Probable Construction Cost</b>				<b>\$ 14,046,000.00</b>
Notes:				
<sup>1</sup> This line item is for capital costs associated with a hexavalent chromium removal system, operations and maintenance costs are in addition to capital costs and are estimated at \$186/acre-foot of water produced. Estimated costs were prepared by Gilmore Engineering, Inc. in January 2015 and provided to AECOM for use in this study.				

**Phase 1, Option 1**

The infrastructure in this alternative described in Appendix C is similar to Table 6.1 except for the following:

- Second Well and Pump \$1,250,000
- 1.8 mile Water Supply Pipeline from CLCSD \$990,000
- Additional engineering costs \$448,000
- Additional contingency costs \$537,600
- Revised Total Opinion of Probable Construction Cost 17,271,600

**CROWS LANDING INDUSTRIAL BUSINESS PARK  
WATER SUPPLY (POTABLE & NON-POTABLE) INFRASTRUCTURE AND FACILITIES STUDY  
FEBRUARY 27, 2015 (UPDATED JANUARY 11, 2018)**

Phase 1, Option 2

The infrastructure in this alternative described in Appendix C is similar to Table 6.1 except for the following:

- Second Well and Pump + engineering and contingency costs \$1,250,000+  
\$550,000
- Revised Total Opinion of Probable Construction Cost \$15,846,000

Phase 1, Option 3

The infrastructure in this alternative described in Appendix C is similar to Table 6.1 except for the following:

- Second Well and Pump + engineering and contingency costs \$1,250,000 +  
\$550,000
- Revised Total Opinion of Probable Construction Cost \$15,846,000

Development of Phase 2 proposes construction of backbone infrastructure to provide potable water service to the Phase 2 areas north of the airport. Potable water infrastructure required as part of Phase 2 improvements includes distribution piping, valves, a potable water storage tank (1.47 MG) in the northeast portion of the project area, and a water well and booster pump station located adjacent to the potable water storage tank. Estimated construction costs for the Phase 2 potable water system construction are provided in Table 6.2.

**Table 6.2 Estimated Phase 2 Onsite Potable Water System Construction Costs**

Description	Quantity	Unit	Unit Price	Cost
<b>SR 33 Corridor South</b>				
12-Inch PVC	32,700	LF	\$ 65.00	\$ 2,125,500.00
12-Inch Gate Valve	32	EA	\$ 1,000.00	\$ 32,000.00
Water Well and Booster Pump Station	1	EA	\$ 2,500,000.00	\$ 2,500,000.00
Potable Water Storage Tank (1.4 MG)	1	EA	\$ 1,650,000.00	\$ 1,650,000.00
Wellhead Treatment System <sup>1</sup>	1	LS	\$ 2,150,000.00	\$ 2,150,000.00
Subtotal				\$ 8,457,500.00
Engineering Costs (20%)				\$ 1,692,000.00
Contingencies (20%)				\$ 2,030,000.00
<b>Total Estimated Opinion of Probable Construction Cost</b>				<b>\$ 12,180,000.00</b>
Notes:				
<sup>1</sup> This line item is for capital costs associated with a hexavalent chromium removal system, operations and maintenance costs are in addition to capital costs and are estimated at \$186/acre-foot of water produced. Estimated costs were prepared by Gilmore Engineering, Inc. in January 2015 and provided to AECOM for use in this study.				

Phase 2, Alternatives A and B

The infrastructure and cost opinions in this alternative described in Appendix C are similar to Table 6.2 except for the following:

- Second Well and Pump + \$1,250,000 +





**CROWS LANDING INDUSTRIAL BUSINESS PARK  
WATER SUPPLY (POTABLE & NON-POTABLE) INFRASTRUCTURE AND FACILITIES STUDY  
FEBRUARY 27, 2015 (UPDATED JANUARY 11, 2018)**

- engineering and contingency costs \$550,000
- Revised Total Opinion of Probable Construction Cost \$13,980,000

**Phase 2, Option 3**

The infrastructure in this alternative described in Appendix C is similar to Table 6.2 except for the following:

- Second Well and Pump + engineering and contingency costs \$1,250,000 + \$550,000
- Intertie Pipeline from CLIB to COP (Cost to be determined)

Development of Phase 3 proposes construction of backbone infrastructure to provide potable water service to the Phase 3 areas south of Marshall Road. Potable water infrastructure required as part of Phase 3 improvements is primarily limited to distribution piping, valves, and a water well and booster pump station located near Marshall Road between Davis Road and State Route 33. Estimated construction costs for the Phase 3 onsite potable water system construction are provided in Table 6.3.

**Table 6.3 Estimated Phase 3 Onsite Potable Water System Construction Costs**

Description	Quantity	Unit	Unit Price	Cost
<b>SR 33 Corridor North</b>				
12-Inch PVC	20,000	LF	\$ 65.00	\$ 1,300,000.00
12-Inch Gate Valve	20	EA	\$ 1,000.00	\$ 20,000.00
Water Well and Booster Pump Station	1	EA	\$ 2,500,000.00	\$ 2,500,000.00
Wellhead Treatment System <sup>1</sup>	1	LS	\$ 2,150,000.00	\$ 2,150,000.00
Subtotal				\$ 5,970,000.00
Engineering Costs (20%)				\$ 1,194,000.00
Contingencies (20%)				\$ 1,433,000.00
<b>Total Estimated Opinion of Probable Construction Cost</b>				<b>\$ 8,597,000.00</b>
Notes:				
<sup>1</sup> This line item is for capital costs associated with a hexavalent chromium removal system, operations and maintenance costs are in addition to capital costs and are estimated at \$186/acre-foot of water produced. Estimated costs were prepared by Gilmore Engineering, Inc. in January 2015 and provided to AECOM for use in this study.				

**Phase 3, Alternatives A, B and C**

The infrastructure and cost opinions of these alternatives described in Appendix C are similar to Table 6.3 except for the following:

- Removal of Well and Pump + engineering and contingency costs -\$1,250,000 - \$550,000
- Revised Total Opinion of Probable Construction Cost \$6,797,000

**CROWS LANDING INDUSTRIAL BUSINESS PARK  
WATER SUPPLY (POTABLE & NON-POTABLE) INFRASTRUCTURE AND FACILITIES STUDY  
FEBRUARY 27, 2015 (UPDATED JANUARY 11, 2018)**

**6.2 PROPOSED NON-POTABLE WATER INFRASTRUCTURE**

Development of Phase 1 proposes construction of backbone infrastructure to provide non-potable water service to the airport, and the Phase 1 area immediately south of the airport, and 15 acres of Public Facilities. Non-potable water infrastructure required as part of Phase 1 improvements includes distribution piping, valves, a non-potable water storage tank (0.75 MG) located south of the airport, a water well adjacent to the non-potable storage tank, and fire hydrants. Estimated construction costs for the Phase 1 non-potable water system construction are provided in Table 6.4.

**Table 6.4 Estimated Phase 1 Non-Potable Water System Construction Costs**

Description	Quantity	Unit	Unit Price	Cost
<b>Phase 1A</b>				
12-Inch PVC	3,500	LF	\$ 65.00	\$ 227,500.00
12-Inch Gate Valve	4	EA	\$ 1,000.00	\$ 4,000.00
Fire Hydrant, Bury, and Gate Valve	11	EA	\$ 5,000.00	\$ 55,000.00
Nonpotable Water Storage Tank (0.75 MG)	1	EA	\$ 1,250,000.00	\$ 1,250,000.00
Subtotal				<b>\$ 1,536,500.00</b>
<b>Phase 1B</b>				
18-Inch PVC	5,300	LF	\$ 100.00	\$ 530,000.00
12-Inch PVC	29,500	LF	\$ 65.00	\$ 1,917,500.00
18-Inch Gate Valve	5	EA	\$ 5,000.00	\$ 25,000.00
12-Inch Gate Valve	29	EA	\$ 1,000.00	\$ 29,000.00
Fire Hydrant, Bury, and Gate Valve	89	EA	\$ 5,000.00	\$ 445,000.00
New Nonpotable Well & Booster Pump Station	1	EA	\$ 2,500,000.00	\$ 2,500,000.00
Nonpotable Water Well Pump	2	EA	\$ 500,000.00	\$ 1,000,000.00
Subtotal				<b>\$ 6,446,500.00</b>
Subtotal of Phase 1				<b>\$ 7,983,000.00</b>
Engineering Costs (20%)				<b>\$ 1,597,000.00</b>
Contingencies (20%)				<b>\$ 1,916,000.00</b>
<b>Total Estimated Opinion of Probable Construction Cost</b>				<b>\$ 11,496,000.00</b>

Phase 1, Alternatives A, B and C

The infrastructure and cost opinions of these alternatives described in Appendix C are similar to Table 6.4.

Development of Phase 2 proposes construction of backbone infrastructure to provide non-potable water service to the Phase 2 areas north of the airport. Non-potable water infrastructure required as part of Phase 2 improvements is primarily limited to distribution piping, fire hydrants, and valves. Estimated construction costs for the Phase 2 non-potable water system construction are provided in Table 6.5.

**CROWS LANDING INDUSTRIAL BUSINESS PARK  
WATER SUPPLY (POTABLE & NON-POTABLE) INFRASTRUCTURE AND FACILITIES STUDY  
FEBRUARY 27, 2015 (UPDATED JANUARY 11, 2018)**

**Table 6.5 Estimated Phase 2 Non-Potable Water System Construction Costs**

Description	Quantity	Unit	Unit Price	Cost
<b>SR 33 Corridor South</b>				
12-Inch PVC	33,000	LF	\$ 65.00	\$ 2,145,000.00
12-Inch Gate Valve	33	EA	\$ 1,000.00	\$ 33,000.00
Fire Hydrant, Bury, and Gate Valve	83	EA	\$ 5,000.00	\$ 415,000.00
Subtotal				\$ 2,593,000.00
Engineering Costs (20%)				\$ 519,000.00
Contingencies (20%)				\$ 623,000.00
<b>Total Estimated Opinion of Probable Construction Cost</b>				<b>\$ 3,735,000.00</b>

Phase 2, Option 1

The infrastructure in this alternative described in Appendix C is similar to Table 6.5 except for the following:

- Second Well and Pump + engineering and contingency costs \$1,250,000 + \$550,000
- Revised Total Opinion of Probable Construction Cost \$5,535,000

Phase 2, Option 2

The infrastructure in this alternative described in Appendix C is similar to Table 6.5 except for the following:

- Second Well and Pump + engineering and contingency costs \$1,250,000 + \$550,000
- Revised Total Opinion of Probable Construction Cost \$5,535,000

Phase 2, Option 3

The infrastructure in this alternative described in Appendix C is similar to Table 6.5 except for the following:

- Second Well and Pump + engineering and contingency costs \$1,250,000 + \$550,000
- Revised Total Opinion of Probable Construction Cost \$5,535,000

Development of Phase 3 proposes construction of backbone infrastructure to provide non-potable water service to the Phase 3 areas south of Marshall Road. Non-potable water infrastructure required as part of Phase 3 improvements includes distribution piping, a water well, fire hydrants, and valves. Estimated construction costs for the Phase 3 non-potable water system construction are provided in Table 6.6.

CROWS LANDING INDUSTRIAL BUSINESS PARK  
 WATER SUPPLY (POTABLE & NON-POTABLE) INFRASTRUCTURE AND FACILITIES STUDY  
 FEBRUARY 27, 2015 (UPDATED JANUARY 11, 2018)

**Table 6.6 Estimated Phase 3 Non-Potable Water System Construction Costs**

Description	Quantity	Unit	Unit Price	Cost
<b>SR 33 Corridor North</b>				
12-Inch PVC	20,000	LF	\$ 65.00	\$ 1,300,000.00
12-Inch Gate Valve	20	EA	\$ 1,000.00	\$ 20,000.00
Fire Hydrant, Bury, and Gate Valve	50	EA	\$ 5,000.00	\$ 250,000.00
Nonpotable Water Well Pump	1	EA	\$ 500,000.00	\$ 500,000.00
Subtotal				\$ 2,070,000.00
Engineering Costs (20%)				\$ 414,000.00
Contingencies (20%)				\$ 497,000.00
<b>Total Estimated Opinion of Probable Construction Cost</b>				<b>\$ 2,981,000.00</b>

Phase 3, Alternatives A, B and C

The infrastructure and cost opinions of these alternatives described in Appendix C are similar to Table 6.6.

## 7.0 WATER SYSTEM MODELING

Section 7 discusses the water model development and hydraulic modeling results.

### 7.1 MODEL DEVELOPMENT

For this study, the modeling software used to evaluate the Project's potable and non-potable water systems is Innovyze InfoWater. Steady-state Average Day Demand (ADD), Maximum Day Demand (MDD), and Peak Hour Demand (PHD) simulations were performed for the potable water system and an MDD irrigation demand with fire flow simulation was performed for the non-potable water system to confirm that the proposed systems will meet the criteria identified in Section 5.

The Project's total demands were distributed to the junction nodes for each system model per the tributary areas; corresponding unit demand factors per acre and peaking factors or fire flows are applied as discussed in Section 3. Each node is assigned an elevation based on the existing topography at the Project site. When multiple nodes are used for a particular land use that ranges in elevation across the area, each node is assigned an elevation within or spanning that elevation range.

Schematic figures for each of the modeling scenarios in Appendix B incorporates the land use plan and show the conceptual alignments, pipe diameters, and node ID's to aid in correlating the modeling results. Element labeling in each schematic figure is consistent with the Key ID's shown in the accompanying data for each scenario.

### 7.2 MODELING ASSUMPTIONS

A Hazen-Williams roughness coefficient "C" value of 130 is assigned for all system piping, which incorporates minor losses associated with fittings, valves, etc.

The supplied pressures at the potable water supply sources are approximately 45 psi and 75 psi for Phases 1 and 2, respectively. The supplied pressure at the non-potable water supply sources is 78 psi

No pressure reducing valves (PRVs) are used in the analysis.

The storage and booster pump system is not included in the model. It is assumed that adequate supply and pressure are available.

### 7.3 MODEL SCENARIOS

The attached model output contains the results for four scenarios:

- Potable Water: Average Day Demand
- Potable Water: Maximum Day Demand
- Potable Water: Peak Hour Demand
- Non-Potable Water: Irrigation Demand with Fire Flow Demand

**CROWS LANDING INDUSTRIAL BUSINESS PARK  
WATER SUPPLY (POTABLE & NON-POTABLE) INFRASTRUCTURE AND FACILITIES STUDY  
FEBRUARY 27, 2015 (UPDATED JANUARY 11, 2018)**

**7.3.1 Fire Flow Analysis**

The non-potable water model evaluates the available fire flow in the system for the Irrigation Demand with Fire Flow Demand Scenario by iteratively imposing the required fire flow demand of 3,000 GPM (in addition to assigned base flow demand, if applicable) at all nodes in the model and calculates the available fire flow at each node, while maintaining a residual pressure of 20 psi at any junction. The residual pressure is identified for each node in the analysis. The system pressure and velocities are then evaluated by applying the required demand at the limiting node (system node with the least available fire flow).

**7.4 MODEL RESULTS**

This section provides a brief description of each analysis for the buildout scenario and a summary of results of the modeling analysis. Data output for each scenario of the modeling analysis is included in Appendix B. Figures 7.1, 7.2, and 7.3 display the potable water system pressures and velocities for the peak hour demand scenario during Phases 1, 2, and 3, respectively. Figures 7.4, 7.5, and 7.6 show residual pressures for the non-potable system under maximum day demand and a 3,000 gpm fire flow for Phases 1, 2, and 3, respectively.

**7.4.1 Potable Water Scenario: Average Day Demand**

For Phase 1, given a supplied system pressures of 45 psi at the Phase 1 supply source, the system pressure throughout the Project during ADD ranges from approximately 48 psi to approximately 69 psi with maximum velocity in the system of approximately 1.3 fps.

For Phases 1 and 2, given supplied system pressures of 45 psi at the Phase 1 supply source and 75 psi at the Phase 2 supply source, the system pressure throughout the Project during ADD ranges from approximately 48 psi to approximately 77 psi with maximum velocity in the system of approximately 1.4 fps.

At buildout, given supplied system pressures of 45 psi at the Phase 1 supply source, 75 psi at the Phase 2 supply source, and 73 psi at the Phase 3 supply source, the system pressure throughout the Project during ADD ranges from approximately 48 psi to approximately 77 psi with maximum velocity in the system of approximately 1.6 fps.

**7.4.2 Potable Water Scenario: Maximum Day Demand**

For Phase 1, given a supplied system pressures of 45 psi at the Phase 1 supply source, the system pressure throughout the Project during MDD ranges from approximately 47 psi to approximately 70 psi with maximum velocity in the system of approximately 2.6 fps.

For Phases 1 and 2, given supplied system pressures of 45 psi at the Phase 1 supply source and 75 psi at the Phase 2 supply source, the system pressure throughout the Project during MDD ranges from approximately 48 psi to approximately 77 psi with maximum velocity in the system of approximately 2 fps.

At buildout, given supplied system pressures of 45 psi at the Phase 1 supply source, 75 psi at the Phase 2 supply source, and 73 psi at the Phase 3 supply source, the system pressure throughout the Project

**CROWS LANDING INDUSTRIAL BUSINESS PARK  
WATER SUPPLY (POTABLE & NON-POTABLE) INFRASTRUCTURE AND FACILITIES STUDY  
FEBRUARY 27, 2015 (UPDATED JANUARY 11, 2018)**

during MDD ranges from approximately 48 psi to approximately 77 psi with maximum velocity in the system of approximately 2.2 fps.

#### 7.4.3 Potable Water Scenario: Peak Hour Demand

For Phase 1, given a supplied system pressures of 45 psi at the Phase 1 supply source, the system pressure throughout the Project during PHD ranges from approximately 41 psi to approximately 54 psi with maximum velocity in the system of approximately 5.2 fps. Figure 7.1 shows the system pressures and velocities.

For Phases 1 and 2, given supplied system pressures of 45 psi at the Phase 1 supply source and 75 psi at the Phase 2 supply source, the system pressure throughout the Project during PHD ranges from approximately 46 psi to 75 psi with maximum velocity in the system of approximately 4 fps.

At buildout, given supplied system pressures of 45 psi at the Phase 1 supply source, 75 psi at the Phase 2 supply source, and 73 psi at the Phase 3 supply source at the point of connection to the water supply source, the system pressure throughout the Project during PHD ranges from approximately 46 psi to approximately 76 psi with maximum velocity in the system of approximately 3.7 fps. Figures 7.1, 7.2, and 7.3 show the onsite system pressures and velocities for the peak hour demand scenarios for Phases 1, 2, and 3, respectively. The modeling data output for this scenario are labeled *Scenario: Potable Water Peak Hour Demand*.

#### 7.4.4 Non-Potable Water Scenario: Maximum Day Irrigation Demand with Fire Flow Demand

For Phase 1, given a supplied system pressure of 78 psi at the point of connection to the water supply source, the lowest residual pressure in the system is approximately 29.8 psi at Junction 27 (J27) during irrigation demand with fire flow demand. Distribution system pipe velocities are under 10 fps for the fire flow scenario.

For Phases 1 and 2, given a supplied system pressure of 78 psi at the point of connection to the water supply source, the lowest residual pressure in the system is approximately 20.9 psi at Junction 6 (J6) during irrigation demand with fire flow demand. Distribution system pipe velocities are under 10 fps for the fire flow scenario.

At buildout, given a supplied system pressure of 78 psi at the point of connection to the water supply source, the lowest residual pressure in the system is approximately 27 psi at Junction 27 (J27) during irrigation demand with fire flow demand. The model shows that given the same supply pressure, Phase 2 has a low system pressure of approximately 20.8 psi at junction 6 (J6). With the proposed improvements scheduled in Phase 3, this situation is greatly improved because of the establishment of a looped system around J6 in Phase 3. The approximate residual pressure at J6 in Phase 3 is 44 psi. Distribution system pipe velocities are under 10 fps for the fire flow scenario.

#### 7.4.5 Pressure System Interties/Zones

A single pressure zone is anticipated within the Project for both the potable and non-potable water systems based on the existing topography of the Project site and the proposed location of the water wells and storage tanks, considering the maximum pressure of 120 psi established for the system service criteria.

**CROWS LANDING INDUSTRIAL BUSINESS PARK  
WATER SUPPLY (POTABLE & NON-POTABLE) INFRASTRUCTURE AND FACILITIES STUDY  
FEBRUARY 27, 2015 (UPDATED JANUARY 11, 2018)**

Several pressure zones requiring pressure reducing valves (PRVs) will be necessary for the proposed potable water transmission main from the WHWD treatment plant to the Project. PRVs will operate to maintain a preset downstream pressure independent of the upstream pressure. Further study is required to determine the limits of each pressure zone and the location of PRV valves. Figure 7.7 shows the layout of the offsite piping in relation to the proposed Project.



## 8.0 FINDINGS

### 8.1 SUPPLY

Given the inherent annual fluctuations in surface water annual deliveries, as well as the lack of existing entitlements or rights, utilization of surface water as the sole or primary supply source for the project is not considered a viable option. Given these considerations, use of groundwater as the sole or primary source of water for the project is considered the most viable and preferred alternative.

Available previous studies of groundwater elevations in the area indicate some decline in local groundwater elevations in recent years, especially between 2011 and 2014. However, this was a period of abnormally low rainfall throughout the state, which resulted in additional groundwater pumping to meet demands that would normally be met from surface water sources. A recent study by Jacobson, James, and Associates conducted in 2016 also indicate that, over time, groundwater elevations are relatively stable, which would indicate a hydrologically balanced condition.

Monitoring and additional studies, if needed, will be necessary to determine the specific effects the project would have on groundwater elevations and the sustainability of the aquifer. This monitoring will be required by the recent state Sustainable Groundwater Management Act (SGMA), as well as the recent 2014 Stanislaus County ordinance amendment. Currently, the CLIBP area is within the DPWD service area and will remain as such until the second phase of development of the CLIBP. During the second phase of development, land that is converted from agricultural to industrial use will be removed from the DPWD. The County has completed an SB 610 Water Supply Assessment that will examine historic and projected water demands and supplies that relate to the CLIBP. Stanislaus County is also working on a Storm Water Resource Plan, which will identify and prioritize projects within the County to address flood flow management and groundwater supply sustainability.

### 8.2 INFRASTRUCTURE

The following summarizes the results of the preliminary infrastructure system design and modeling:

- Total potable water demand for the buildout of the Project for ADD, MDD, and PHD are 1.34 MGD, 2.67 MGD, and 5.35 MGD, respectively.
- Total potable water demand for Phase 1A of the Project for ADD, MDD, and PHD are 0.15 MGD, 0.31 MGD, and 0.62 MGD, respectively.
- Total potable water demand for Phase 1 of the Project for ADD, MDD, and PHD are 0.59 MGD, 1.18 MGD, and 2.37 MGD, respectively.
- Total potable water demand for Phase 2 of the Project for ADD, MDD, and PHD are 0.35 MGD, 0.71 MGD, and 1.42 MGD, respectively.
- Total potable water demand for Phase 3 of the Project for ADD, MDD, and PHD are 0.41 MGD, 0.82 MGD, and 1.64 MGD, respectively.
- Required potable water storage volume for buildout of the Project is approximately 2.71 MGD.
- Required potable water storage volume for Phase 1 of the Project is approximately 1.19 MGD.

**CROWS LANDING INDUSTRIAL BUSINESS PARK  
WATER SUPPLY (POTABLE & NON-POTABLE) INFRASTRUCTURE AND FACILITIES STUDY  
FEBRUARY 27, 2015 (UPDATED JANUARY 11, 2018)**

- Required potable water storage volume for Phase 2 of the Project is approximately 1.52 MGD. This total accounts for the additional storage needed for Phase 3.
- Required potable water storage volume for Phase 3 of the Project is approximately 0.82 MGD. This volume is shown for informational purposes only and is not in addition to the storage requirements shown for Phases 1 and 2.
- The potable water storage tanks will be located on-site.
- Total non-potable water demand for the buildout of the Project for irrigation demand is 1.20 MGD. A fire flow demand of 3,000 gpm is anticipated for the buildout of the project and will be supplied by the non-potable system but is considered separate from the irrigation average demand.
- Total non-potable water demand for Phase 1A of the Project for average day irrigation demand is 0.103 MGD. This flow does not account for the 3,000 gpm fire flow demand.
- Total non-potable water demand for Phase 1 of the Project for average day irrigation demand is 0.68 MGD. This flow does not account for the 3,000 gpm fire flow demand.
- Total non-potable water demand for Phase 2 of the Project for irrigation demand plus fire flow demand is 0.24 MGD. This flow does not account for the 3,000 gpm fire flow demand.
- Total non-potable water demand for Phase 3 of the Project for irrigation demand plus fire flow demand is 0.27 MGD. This flow does not account for the 3,000 gpm fire flow demand.
- The required non-potable water pump station for the Project should be sized to meet the projected maximum day irrigation demand. It is recommended that an additional set of pumps be constructed and sized to meet fire flow demands. These pumps should be separate from the irrigation pumps due to the large disparity between irrigation demands and fire flow demands. The non-potable water pump provided as part of Phase 1 improvements shall be sized to accommodate both the irrigation and fire flow demands at Project buildout. The water supply alternatives presented in Appendix C presents somewhat different phasing for non-potable water, including a second supply well in Phase 2.
- Required non-potable water storage volume for the Project is approximately 0.72 MGD. The total required non-potable water storage volume will be provided on-site as part of Phase 1 improvements.
- The potable and non-potable water systems within the Project will consist of a single pressure zone.
- Several pressure zones requiring pressure reducing valves (PRVs) will be necessary for the proposed potable water transmission main from the WHWD treatment plant to the Project.
- Potable water distribution piping will be a minimum of 12 inches in diameter in order to meet the criteria identified in Section 5.
- Non-potable water distribution piping ranges in size from 12 inches in diameter to 18 inches in diameter in order to meet the criteria identified in Section 5.

**CROWS LANDING INDUSTRIAL BUSINESS PARK  
WATER SUPPLY (POTABLE & NON-POTABLE) INFRASTRUCTURE AND FACILITIES STUDY  
FEBRUARY 27, 2015 (UPDATED JANUARY 11, 2018)**

- All water supply alternatives presented in Appendix C include two water supply wells in Phase 1 and two wells in Phase 2.
- Option 1 in Appendix C combines the water systems of the CLCSD and the CLIBP under an existing water permit. This would also allow blending of water supplies from either district that may avoid the need for separate water or wellhead treatment.
- Option 2 in Appendix C includes on-site development of water supplies at CLIBP under a new water permit. Proposed infrastructure is similar to the original will Phase 1, 2 and 3 facilities included in this study with additional wells.
- Option 3 in Appendix C includes infrastructure identical to Option 2, plus an intertie corridor and pipeline to the COP with both districts under an existing water permit. All three of the alternatives are to be presented for consideration in the EIR.

CROWS LANDING INDUSTRIAL BUSINESS PARK  
WATER SUPPLY (POTABLE & NON-POTABLE) INFRASTRUCTURE AND FACILITIES STUDY  
FEBRUARY 27, 2015 (UPDATED JANUARY 11, 2018)

## 9.0 REFERENCES

1. Stanislaus County Redevelopment Agency, 2009. *Revised Preliminary Redevelopment Plan, Crows Landing Air Facility Project Area: Stanislaus County*. February 2009.
2. USBR, M&I, 2005: United States Dept. of the Interior, Bureau of Reclamation, Mid-Pacific Region, *Finding of No Significant Impact, Central Valley Project Municipal and Industrial Water Shortage Policy, Central Valley Project, California*, Approved December 19, 2005
3. USBR, M&I, 2014: United States Dept. of the Interior, Bureau of Reclamation, Mid-Pacific Regional Office, *Central Valley Project Municipal and Industrial Water Shortage Policy Draft Environmental Impact Statement*, November 2014
4. USBR, Contractors List, 2014: United States Dept. of the Interior, Bureau of Reclamation, Mid-Pacific Regional Office, *Central Valley Project (CVP) Water Contractors*, Revised 03/04/2014.
5. DWR Notices 2013-2014: California Department of Water Resources, *Notice to State Water Contractors*, November 19, 2013; January 31, 2014; April 18, 2014; and May 30, 2014.
6. DWR 2004: California Department of Water Resources, *Management of the California State Water Project, Bulletin 132-03*, December 2004.
7. DWR 2014: California Department of Water Resources, *Management of the California State Water Project, Bulletin 132-12*, August 2014.
8. *City of Patterson Water Supply Analysis for General Plan Update*, The H2O Group, Inc., June 2010
9. *City of Patterson 2010 Urban Water Management Plan*, The H2O Group, Inc., June 2011.
10. USBR, Warren Act, 2014: United States Dept. of the Interior, Bureau of Reclamation, Mid-Pacific Region, *Draft Finding of No Significant Impact, West Stanislaus Irrigation District Warren Act Contracts, FONSI-14-050*, November 2014
11. USBR, Warren Act, 2015: United States Dept. of the Interior, Bureau of Reclamation, Mid-Pacific Region, *Draft Finding of No Significant Impact, Warren Act Contracts for Banta-Carbona Irrigation District, Byron-Bethany Irrigation District, and Patterson Irrigation District, FONSI-14-121*, approved February 12, 2015
12. SWRCB 2014: California State Water Resources Control Board, *Notice of Unavailability of Water and Immediate Curtailment for Those Diverting Water in the Sacramento and San Joaquin River Watersheds With a Post-1914 Water Right*, May 27, 2014
13. SWRCB 2015: California State Water Resources Control Board, *Fact Sheet, Water Right Holders Likely to Face Curtailment in 2015*, Updated January 29, 2015
14. USBR, ROD, 2009: United States Dept. of the Interior, Bureau of Reclamation, Mid-Pacific Region, *Record of Decision, Delta-Mendota Canal / California Aqueduct Intertie Final Environmental Impact Statement*, Approved December 28, 2009.

**CROWS LANDING INDUSTRIAL BUSINESS PARK  
WATER SUPPLY (POTABLE & NON-POTABLE) INFRASTRUCTURE AND FACILITIES STUDY  
FEBRUARY 27, 2015 (UPDATED JANUARY 11, 2018)**

15. Diablo Grande, 2014: Diablo Grande Community, *Fact Sheet: The Allocation and Purchase of Water for Diablo Grande*, “Information accurate as of 3/2014”
16. CDPH 2014: Obtained from CDPH EDT Library and Water Quality Analyses Data and Download Page:  
[www.waterboards.ca.gov/drinking\\_water/certlic/drinkingwater/EDTlibrary.shtml](http://www.waterboards.ca.gov/drinking_water/certlic/drinkingwater/EDTlibrary.shtml)
17. Department of Water Resources (DWR). 2003. *California’s Groundwater Bulletin 118 – Update 2003*.
18. Department of Water Resources (DWR). 2006. *California’s Groundwater Bulletin 118, San Joaquin Valley Groundwater Basin, Delta-Mendota Subbasin*. Update January 20, 2006.
19. San Luis & Delta-Mendota Water Authority: *Groundwater Management Plan for the Northern Agencies in the Delta-Mendota Canal Service Area*, AECOM, Revised November 7, 2011
20. Kenneth D. Schmidt and Associates, 2013: Supplement to Water Supply Assessment for Arambel Business Park / KDN Retail Center. August 2013.
21. Oneida Total Integrated Enterprises (OTIE): *Final April 2013 through February 2014 Groundwater Monitoring Report, Installation Restoration Program Site 17 (Administration Area Plume), Former NASA Crows Landing Flight Facility, Crows Landing, California*. June 2014.
22. CH2M Hill Kleinfelder, A Joint Venture (KCH), 2014. *Draft Final Remedial Design and Design Basis Report, NASA Crows Landing Flight Facility, Crows Landing, California*. June 2014.
23. Mays, Larry W. 2000. *Water Distribution System Handbook*. New York: The McGraw-Hill Companies, Inc.
24. COM 2014: City of Modesto, *Standard Specifications*, 2014. Section 6.05-D.2 reference the “City’s Engineer’s Report” for determining water use factors. The most current report as of this report is the *City of Modesto Water System Engineer’s Report*, prepared by West Yost & Associates, dated May 2010. Appendix D provides water use factors and determination of peaking factors for max. day and peak hour demands.
25. Michael Brandman Associates. 2013. *Municipal Service review/Sphere of Influence Plan City of Patterson, Stanislaus County, California*.
26. Jacobson, James, and Associates, 2016. *Groundwater Resources Impact Assessment: Crows Landing Industrial Business Park Stanislaus County, California*. August 2016.

CROWS LANDING INDUSTRIAL BUSINESS PARK  
WATER SUPPLY (POTABLE & NON-POTABLE) INFRASTRUCTURE AND FACILITIES STUDY  
FEBRUARY 27, 2015 (UPDATED JANUARY 11, 2018)

Figure 1.1: Crows Landing Industrial Park – Conceptual Phasing Map



# APPENDIX A

## Groundwater Resources Impact Assessment



---

# Groundwater Resources Impact Assessment

Crows Landing Industrial Business Park  
Stanislaus County, California

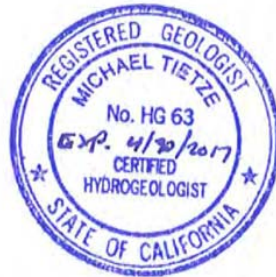
October 31, 2016



Prepared By

A handwritten signature in blue ink, appearing to read 'Joel Bauman', written over a horizontal line.

Joel Bauman, PG, PMP  
Principal Geologist



Reviewed By

A handwritten signature in blue ink, appearing to read 'Mike Tietze', written over a horizontal line.

Mike Tietze, PG, CEG, CHG  
Principal Engineering Geologist

**JACOBSON | JAMES**  
& a s s o c i a t e s , i n c

9083 Foothills Blvd., Suite 370  
Roseville, California 95747  
(916) 367-5111

<b>TABLE OF CONTENTS</b>		<b>PAGE</b>
<b>LIST OF TABLES</b> .....		<b>iii</b>
<b>LIST OF FIGURES</b> .....		<b>iii</b>
<b>LIST OF APPENDICES</b> .....		<b>iii</b>
<b>LIST OF ACRONYMS AND ABBREVIATIONS</b> .....		<b>iv</b>
<b>1.0 INTRODUCTION</b> .....		<b>1-1</b>
1.1 Background .....		1-1
1.2 Organization .....		1-1
<b>2.0 PROJECT DESCRIPTION</b> .....		<b>2-1</b>
2.1 Project Overview .....		2-1
2.2 Water Demand and Supply Development.....		2-1
2.3 Applicable Regulations.....		2-4
<b>3.0 PROJECT SETTING</b> .....		<b>3-1</b>
3.1 Existing Site Conditions and Topography .....		3-1
3.2 Climate .....		3-1
3.3 Surface Hydrology .....		3-1
3.4 Hydrogeology .....		3-2
3.4.1 Groundwater Levels and Flow .....		3-2
3.4.2 Aquifer Properties .....		3-4
3.4.3 Groundwater Quality .....		3-5
3.4.4 Groundwater Budget and Existing Groundwater Demand .....		3-6
3.5 Subsidence .....		3-7
<b>4.0 EVALUATION OF HYDROGEOLOGIC EFFECTS</b> .....		<b>4-1</b>
4.1 Conceptual Understanding .....		4-1
4.2 Analytical Drawdown Model .....		4-2
4.2.1 Approach .....		4-2
4.2.2 Model Inputs .....		4-5
4.2.3 Model Scenarios .....		4-5
4.2.4 Assumptions and Limitations .....		4-5
4.3 Results .....		4-6
<b>5.0 IMPACT EVALUATION</b> .....		<b>5-1</b>
5.1 Groundwater-Dependent Ecosystems .....		5-1
5.2 Water Quality .....		5-2
5.3 Subsidence .....		5-2
5.4 Chronic Drawdown and Diminution of Supply .....		5-3
5.5 Water Supply and Entitlements.....		5-5
5.6 Proposed Mitigation Measures .....		5-5
5.6.1 MM Water-01 – Subsidence Monitoring .....		5-5
5.6.2 MM Water-02 – Well Setbacks .....		5-6
5.6.3 MM Water-03 – Groundwater Level Monitoring.....		5-6
5.6.4 MM Water-04 – Recharge Enhancement Plan.....		5-6

**6.0 REFERENCES .....6-1**

**LIST OF TABLES**

Table 2.2.1	Project Groundwater Demand and Supply
Table 3.4.1	Aquifer Properties Estimated from Specific Capacity Tests
Table 3.4.2	Historical Site Groundwater Pumpage and Surface Water Deliveries
Table 4.2.1	Analytical Model Input Parameters
Table 4.2.2	Analytical Modeling Scenarios

**LIST OF FIGURES**

Figure 2.1.1	Site Map
Figure 2.1.2	Proposed Facility Layout
Figure 3.4.1	Hydrographs for Confined Aquifer Wells Located Near the Site
Figure 4.2.1	Model Domain Boundaries and Features
Figure 4.2.2	Conceptual Illustration of Model Construction
Figure 4.3.1	Predicted Drawdown in the Confined Aquifer for Scenarios 1 through 4, End of Phase 1
Figure 4.3.2	Predicted Drawdown in the Confined Aquifer for Scenarios 1 through 4, End of Phase 2
Figure 4.3.3	Predicted Drawdown in the Confined Aquifer for Scenarios 1 through 4, End of Phase 3

**LIST OF APPENDICES**

Appendix A	Evaluation of Potential Stormwater Capture Efficiency from Low Impact Development Standards
Appendix B	Groundwater Elevation Contour Maps from the DWR Groundwater Information Center Interactive Mapping Application

## LIST OF ACRONYMS AND ABBREVIATIONS

AFY	acre-feet per year
amsl	above mean sea level
bgs	below ground surface
CEQA	California Environmental Quality Act
CLIBP	Crows Landing Industrial Business Park
CVP	Central Valley Project
DMGS	Delta-Mendota Groundwater Subbasin
DPWD	Del Puerto Water District
DWR	California Department of Water Resources
EIR	Environmental Impact Report
EPA	U.S. Environmental Protection Agency
ft/day	foot per day
GDE	groundwater-dependent ecosystem
gpd/ft <sup>2</sup>	gallon per day per square foot
gpm	gallon per minute
gpm/ft	gallon per minute per foot
GSP	Groundwater Sustainability Plan
JJ&A	Jacobson James & Associates, Inc.
KDSA	Kenneth D. Schmidt and Associates
LID	Low Impact Development
MCL	Maximum Contaminant Level
MM	Mitigation Measure
NASA	National Aeronautics and Space Administration
SGMA	Sustainable Groundwater Management Act
SWP	State Water Project
SWRCB	State Water Resources Control Board
TDS	total dissolved solids
USGS	U.S. Geological Survey
UWMP	Urban Water Management Plan

## 1.0 INTRODUCTION

### 1.1 Background

Stanislaus County proposes rezoning of the former National Aeronautics and Space Administration (NASA) Crows Landing Air Facility to construct the Crows Landing Industrial Business Park (CLIBP), located in Stanislaus County south of Patterson, California (the Project). The CLIBP proposes to use groundwater as a water supply during construction and operation. This Groundwater Resources Impact Assessment Report has been prepared by Jacobson James & Associates, Inc. (JJ&A) on behalf of the Stanislaus County Department of Public Works, to provide information regarding groundwater resources that will be incorporated into the environmental analysis of the proposed Project under the California Environmental Quality Act (CEQA). Specifically, this report describes the affected groundwater resources environment, the groundwater resources demand and development activities associated with the proposed CLIBP, and the methods and results of a groundwater resources impact assessment for the proposed Project. The information contained in this report will be incorporated into the Environmental Impact Report (EIR) prepared for the Project.

### 1.2 Organization

This report includes the following sections:

- Chapter 1, *Introduction*, which identifies the background, purpose and scope of the study.
- Chapter 2, *Project Description*, which provides a brief overview of the proposed Project and discusses the anticipated water demand and proposed groundwater supply development activities.
- Chapter 3, *Project Setting*, which provides an overview of the project setting, with a particular focus on hydrogeology and groundwater resources.
- Chapter 4, *Drawdown Evaluation*, which presents the methods and results of an evaluation of the proposed groundwater extraction on groundwater levels and flow.
- Chapter 5, *Groundwater Resources Impact Analysis*, which presents a reasoned analysis of the potential impacts of the proposed groundwater supply development associated with the project on the environment.
- Chapter 6, *References*, which includes a list of documents cited in this report.

## 2.0 PROJECT DESCRIPTION

### 2.1 Project Overview

CLIBP is a conceptually planned development that encompasses the reuse of the former Crows Landing Air Facility, which was decommissioned by NASA in the late 1990s. The proposed CLIBP location is shown on Figure 2.1.1, and includes approximately 1,528 acres of land (hereinafter the Site). The proposed CLIBP layout is shown on Figure 2.1.2. The CLIBP is planned to include aviation, multimodal transportation, industrial and commercial facilities, which are proposed to be constructed on 1,261 developable acres in three phases:

- Phase 1 will be developed between 2017 and 2026, and includes construction of approximately 810 acres of aviation, multimodal, industrial and commercial facilities;
- Phase 2 will be developed from 2027 to 2036, and consists of construction of an additional 177 acres of multimodal, industrial and commercial facilities; and
- Phase 3 will be developed between 2037 and 2046, and includes construction of the final 274 acres of multimodal, industrial and commercial facilities.

### 2.2 Water Demand and Supply Development

A Water Supply Assessment and Water Supply Feasibility Study were prepared for the CLIBP by AECOM (AECOM, 2016a; AECOM and VVH Consulting Engineers, 2016). The water demand for the CLIBP will include potable, irrigation, fire water, and other non-potable water needs, and is proposed to be supplied from a combination of existing and new groundwater supply wells at the Site. As discussed further in Section 3.4, the groundwater resources beneath the Site that are available for supply development include a shallow unconfined aquifer that is separated from a deeper confined aquifer by a relatively impermeable regional aquitard layer referred to as the Corcoran Clay.

Table 2.2.1 below summarizes the projected water demand as the CLIBP is developed over time. The demand is presented as the estimated total at full buildout of each development phase. The project will develop a non-potable water supply using combination of the existing irrigation wells that derive water from both the shallow and deep aquifer, and new non-potable supply wells installed into the shallow aquifer beneath the Site. The project potable water supply will be developed using new wells installed into the confined aquifer beneath the Site.

**Table 2.2.1 Project Groundwater Demand and Supply**

Time Period	Annual Groundwater Demand at Completion of Each Buildout Phase (acre-feet/year [AFY])		
	Phase 1 2017 to 2026	Phase 2 2027 to 2036	Phase 3 2037 to 2046
Estimated Total Potable Demand	739	1,036	1,496
Estimated Total Non-Potable Demand	818	1,014	1,323
<b>Estimated Total Project Demand</b>	<b>1,557</b>	<b>2,053</b>	<b>2,819</b>
Potable Supply from New Confined Aquifer Wells	739	1,036	1,496
Non-Potable Supply from Existing Wells	818	834	834
Non-Potable Supply from New Shallow Aquifer Wells	0	183	489

The Project non-potable water supply will be developed as follows:

- As discussed further in Section 3.4.4 and summarized in Table 3.4.2, the three existing wells at the Site have historically been pumped at an average rate of approximately 834 acre-feet per year (AFY). It is assumed that the existing wells will be capable of supporting groundwater extraction at their historical annual extraction volumes when pumped year round. If the existing wells fail to supply the assumed 834 AFY, they would be supplemented, as needed, through the installation of new wells of similar construction.
- Any non-potable Project water demand in excess of 834 AFY is assumed to be supplied using new shallow aquifer wells that are installed at the Site.
- Optimal locations for the new shallow aquifer wells will be selected based on performance of the existing wells, groundwater level monitoring data developed during project operation, and additional water supply development studies, as needed.
- Shallow groundwater demand in excess of the historical average shallow aquifer extraction rate (183 AFY at Phase 2 buildout and 489 AFY at Phase 3 buildout) will be offset by an equivalent volume of increased recharge relative to current conditions, such that the net groundwater extraction rate from the shallow aquifer does not increase above historical levels. This increased shallow aquifer recharge will be derived from a combination of the following sources:<sup>1</sup>
  - Discharge from Little Salado Creek and Marshall Drain will be captured and recharged at facilities constructed for the CLIBP. A long, linear stormwater retention/detention basin

<sup>1</sup> Mitigation Measure (MM) Water-04, described in Section 5.6.4, requires that a Recharge Enhancement Plan be prepared that describes how the Project will achieve sufficient recharge to fully offset any additional groundwater demand on the shallow aquifer imposed by the Project.

will be constructed on the north side of the Site by widening approximately 4,000 feet of Little Salado Creek and Marshall Drain from the current width of approximately 15 feet to over 250 feet, and modifying the streambed to increase its permeability (AECOM, 2016b). The basin will be designed for retention of 200 acre-feet (the estimated runoff volume of a 2-year storm event) and detention of an additional 180 acre-feet. Based on the available information, it is reasonable to expect that several hundred acre-feet per year of groundwater can be recharged to the shallow aquifer in these facilities compared to current conditions.<sup>2</sup>

- Developments within the CLIBP will be required to implement Low Impact Development (LID) standards that promote on-Site stormwater retention and recharge (AECOM, 2016c). Design Goal D-25 requires that all stormwater be retained on the individual lease holds (parcels) to be developed at the CLIBP. This will result in additional recharge relative to the current condition.<sup>3</sup>
- Developments within the CLIBP will be required to employ landscape planting strategies and xeriscape designs to decrease non-potable water demand. The non-potable water demand estimate presented in Table 2.2.1 is based on conservative default development assumptions in Stanislaus County (AECOM, 2016a; AECOM and VVH Consulting Engineers, 2016), and does not consider the implementation of xeriscape planting standards. It is reasonable to assume that landscaping associated with project buildout using these methods can result in a non-potable water demand reduction of several hundred acre-feet, which may be considered net *in lieu* recharge to the shallow aquifer.

The CLIBP potable water supply is assumed to be developed as follows:

- It is assumed that the new water supply wells will be installed into the confined aquifer underlying the Corcoran Clay at the approximate locations shown on Figure 2.1.1. The potable supply wells will be constructed to pump water from the full usable depth of this aquifer. On a preliminary

---

<sup>2</sup> For perspective, the Little Salado Creek watershed occupies an area of approximately 10.8 square miles and has an average annual discharge of approximately 874 AFY (AECOM, 2016b). The reported discharge in Marshall Drain ranged from 1,147 to 2,731 AFY between 2005 and 2011 (Summers Engineering, 2013), and includes discharge from Little Salado Creek and local agricultural drainage, minus any existing recharge. Recharge from streams is proportional to streambed conductance, which is the product of the streambed thickness and width, times its vertical hydraulic conductivity. The proposed construction of the project retention/detention basin will increase the streambed width by at least an order of magnitude, and modify the bed of the basin to increase its permeability. It is reasonable to assume that construction and maintenance of the basin can increase its conductance by approximately two orders of magnitude, increasing the recharge through the basin by approximately 100-fold relative to the existing condition.

<sup>3</sup> Based on a screening-level evaluation using the U.S. Environmental Protection Agency (EPA) National Stormwater Calculator (EPA, 2014) presented in Appendix A, it is anticipated that application of LID elements in site-specific construction can capture and infiltrate up to approximately 200 AFY of stormwater relative to Project buildout without parcel-specific LID elements. A detailed analysis relative to current conditions has not been performed, so the amount of recharge compared to current conditions may be different; however, the analysis indicates that significant recharge can be achieved through the implementation of LID elements.



basis, screen intervals are assumed to extend from approximately 320 to 870 feet below ground surface (bgs).

- Groundwater extracted from the confined aquifer for potable use will be treated to meet applicable water quality standards.

## 2.3 Applicable Regulations

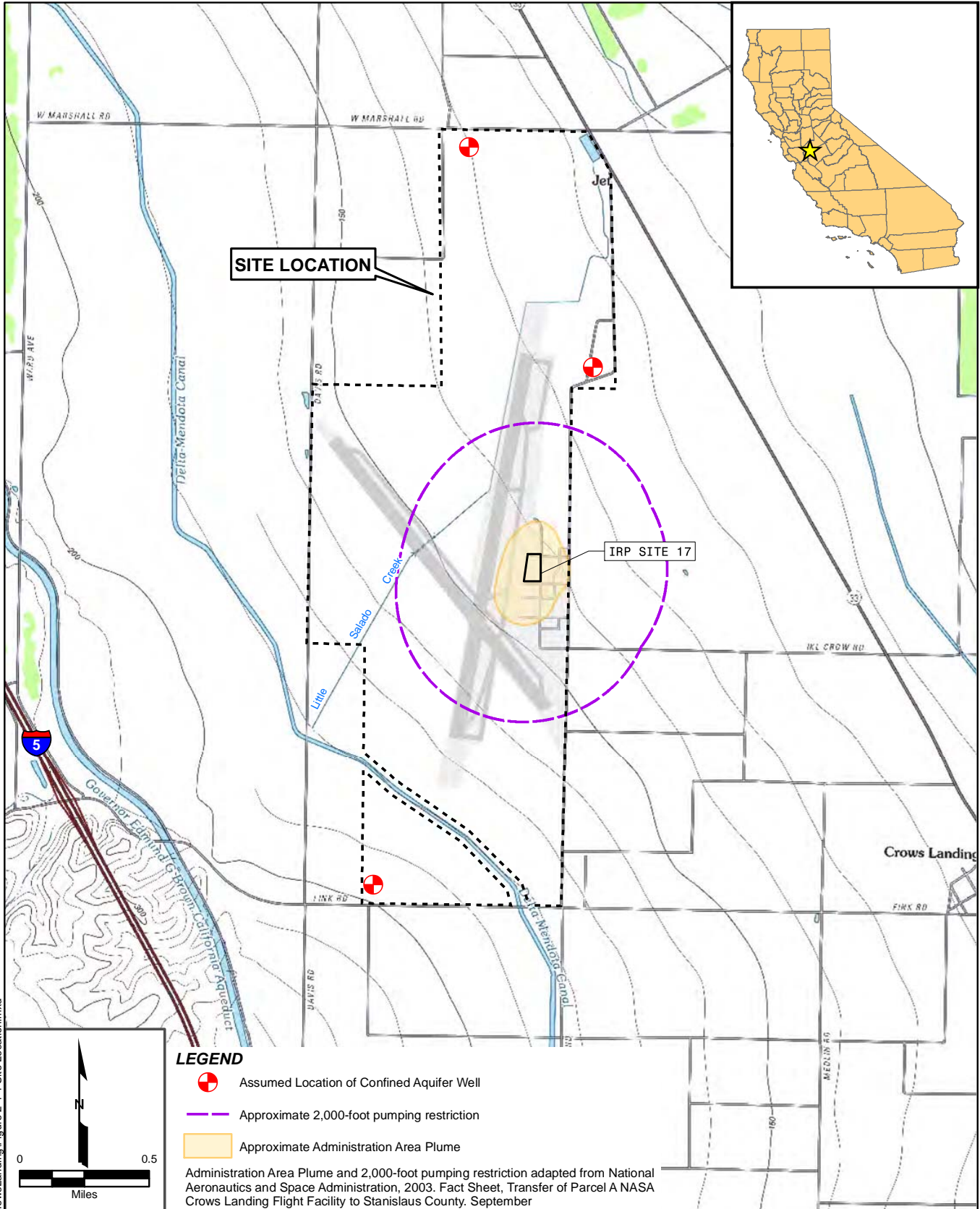
The Site is not located in an adjudicated basin or in a special act district that regulates the extraction of groundwater. The Project would be able to supply groundwater for beneficial use on the properties to be developed in the business park under an appropriate groundwater right. No new entitlements would be required.

Development of groundwater resources to support the Project must comply with the Stanislaus County Groundwater Ordinance adopted in November 2014 (Chapter 9.37 of the Stanislaus County Code), which codifies requirements, prohibitions, and exemptions for permitting new wells with the intent of supporting sustainable groundwater extraction. In addition, the Project will have to comply with the requirements of a Groundwater Sustainability Plan (GSP) that will be adopted for the area by 2020 under California's new Sustainable Groundwater Management Act (SGMA). Stanislaus County's Groundwater Ordinance is deliberately aligned with the requirements of SGMA. Under the Ordinance, unless otherwise exempt, an applicant that wishes to install a new groundwater well must first provide substantial evidence the well is not unsustainably extracting groundwater as defined in the Ordinance and in SGMA. The County has determined that the CLIBP is not exempt from these requirements. The Ordinance and SGMA define unsustainable extraction as causing undesirable results, which are defined as meaning one or more of the following:




- Chronic lowering of groundwater levels indicating a significant and unreasonable depletion of supply if continued over the planning and implementation horizon. Overdraft during a period of drought is not sufficient to establish a chronic lowering of groundwater levels if extractions and recharge are managed as necessary to ensure that reductions in groundwater levels or storage during a period of drought are offset by increases in groundwater levels or storage during other periods.*
- Significant and unreasonable reduction of groundwater storage.*
- Significant and unreasonable degraded water quality, including the migration of contaminant plumes that impair water supplies.*
- Significant and unreasonable land subsidence that substantially interferes with surface land uses.*
- Surface water depletions that have significant and unreasonable adverse impacts on beneficial uses of the surface water.*

Prior to issuing a permit to construct a new groundwater supply well, the County must review information provided by the applicant and make a determination whether it constitutes substantial evidence that the proposed groundwater extraction will not cause or contribute to one or more of the above undesirable

results. To that end, it should be noted that the undesirable results listed above are aligned with questions contained in Appendix G of the State CEQA Guidelines, which are evaluated in Section 5.0 of this report. As such, this report fulfills the substantial evidence requirement for demonstrating compliance with the sustainable groundwater management requirements in the Stanislaus County Groundwater Ordinance.




**LEGEND**

-  Assumed Location of Confined Aquifer Well
-  Approximate 2,000-foot pumping restriction
-  Approximate Administration Area Plume

Administration Area Plume and 2,000-foot pumping restriction adapted from National Aeronautics and Space Administration, 2003. Fact Sheet, Transfer of Parcel A NASA Crows Landing Flight Facility to Stanislaus County. September

Path: J:\GIS\StanislausCounty\CrowsLanding\Figure 2-1-1 Site Location.mxd

	TITLE: <b>SITE MAP</b>	DATE: 8/2/16
	LOCATION: <b>CROWS LANDING INDUSTRIAL BUSINESS PARK          STANISLAUS COUNTY, CALIFORNIA</b>	FIGURE: <b>2.1.1</b>

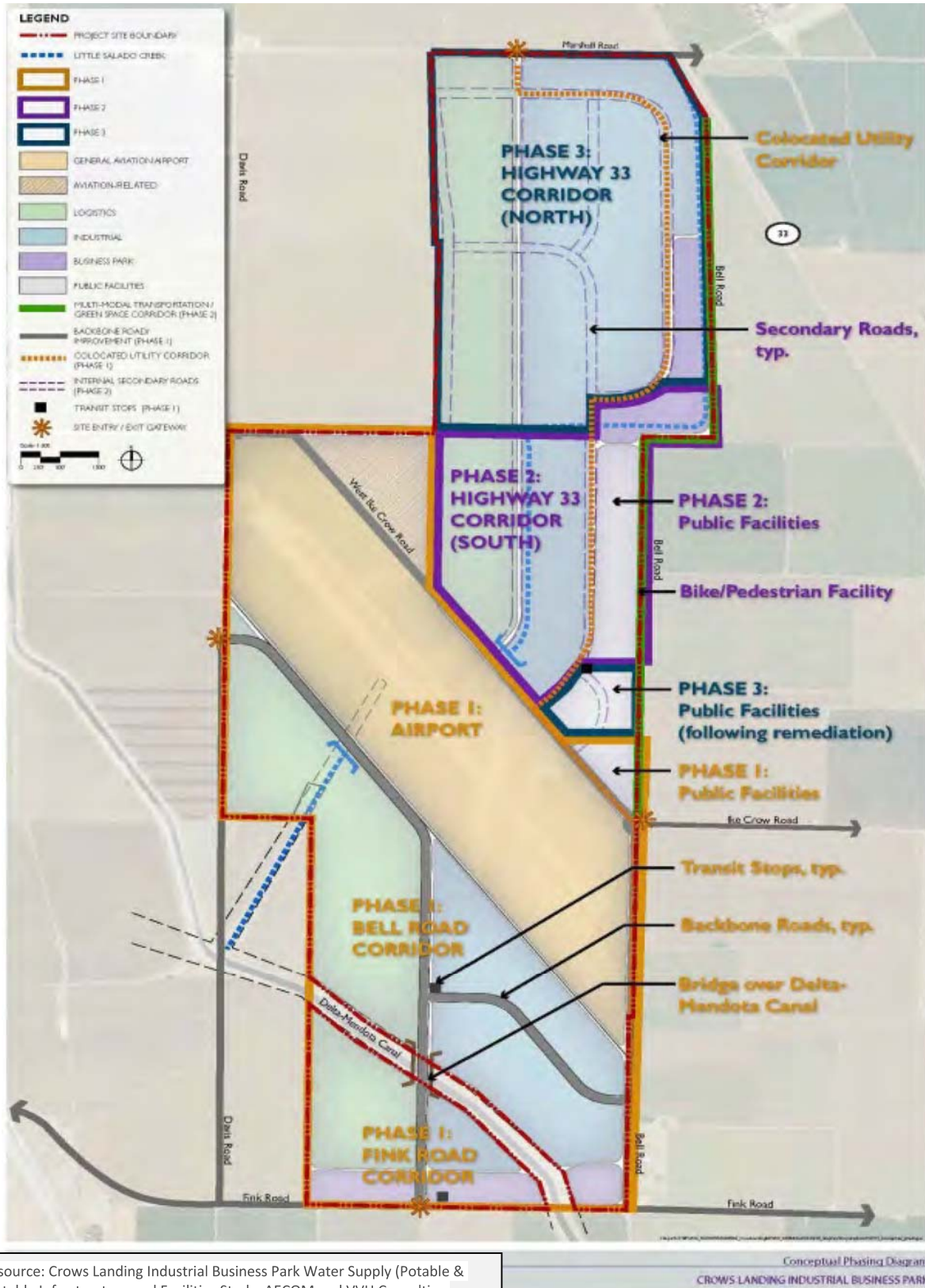


Figure source: Crows Landing Industrial Business Park Water Supply (Potable & Non-Potable Infrastructure and Facilities Study. AECOM and VVH Consulting Engineers, updated February 17, 2016.

<b>JACOBSON   JAMES</b> & associates, inc	TITLE:	<b>PROPOSED FACILITY LAYOUT</b>	DATE:	07/28/16
	LOCATION:	Crows Landing Industrial Business Park Stanislaus County, California		FIGURE:

## **3.0 PROJECT SETTING**

### **3.1 Existing Site Conditions and Topography**

The Site is located in a predominantly agricultural area of rural Stanislaus County. It is located east of Interstate 5, west of State Route 33, south of the City of Patterson, and approximately 1 mile west of the unincorporated community of Crows Landing. It is bounded on the east by Bell Road, on the south by Fink Road, on the west by Davis Road, and on the north by Marshall Road and State Route 33. The Delta-Mendota Canal traverses the southern portion of the Site in a northwest/southeast direction. The Site is occupied by abandoned runways, taxiways, buildings and other facilities associated with the former Crows Landing airfield, surrounded by approximately 1,200 acres of cultivated agricultural land. Paved and unpaved access roads traverse the Site

Physiographically, the Site is located on the San Joaquin Valley floor, approximately 1 to 2 miles east of the Diablo Range, and 4 to 6 miles west of the San Joaquin River. The western margin of the valley consists of low hills and dissected alluvial fans at the foot of the Diablo Range. A short distance to the east, elevations drop off into alluvial and flood plains associated with the San Joaquin River. The Delta-Mendota Canal and California Aqueduct run along the western margin of the valley. The Site slopes gently to the northeast from a high elevation of approximately 180 feet above mean sea level (amsl) near the southwest Site corner to approximately 110 feet amsl near the intersection of State Route 33 and Marshall Road.

### **3.2 Climate**

The area has a “Mediterranean” climate characterized by hot, dry summers and short, wet winters, and averages over 260 sunny days per year. The average annual precipitation at the Modesto meteorological station is just over 13 inches per year, with 88 percent of the precipitation occurring between November and April (Turlock Irrigation District, 2012; Sperling’s Best Places, 2016).

Much of California, including the Central Valley, has experienced unprecedented drought conditions over the last four years. As a result, water conservation measures have been mandated, delivery of surface water from the state and federal water systems has been curtailed, and reliance on groundwater resources for agricultural uses has increased.

### **3.3 Surface Hydrology**

Drainage in the Site vicinity is generally toward the northeast, from streams draining the Diablo Range and along the natural slope of the valley floor toward the San Joaquin River. Drainage from the agricultural fields and airfield areas of the site is routed to Little Salado Creek, which traverses the Site in a northeasterly direction. Little Salado Creek is an ephemeral stream that drains the eastern slope of the Diablo Range, and discharges to Marshall Drain near the northeast corner of the Site. Marshall Drain transitions to an underground pipe near the intersection of Marshall Road and State Route 33. The average annual discharge

on Little Salado Creek is estimated to be approximately 874 AFY (AECOM and VVH Consulting Engineers, 2016).

The dissected alluvial terrace deposits west of the Site at the base of the coast range generally do not contain shallow groundwater; however, due to their coarse grained nature, they are considered potentially important for groundwater recharge. When sufficient runoff occurs, it eventually drains to the San Joaquin River, approximately 4 to 6 miles east of the Site.

### **3.4 Hydrogeology**

The Site is located in the Delta-Mendota Groundwater Subbasin (DMGS) of the San Joaquin Valley Groundwater Basin. Within Stanislaus County, the DMGS is bounded to the east by the San Joaquin River and to the west by low-permeability bedrock of the Coast Ranges that is associated with Tertiary and older marine formations. The subbasin extends southward from the northern boundary of Stanislaus County along the west side of San Joaquin Valley for approximately 80 miles, and crosses a total of four counties, encompassing an area of approximately 747,000 acres. The total estimate storage capacity of the DMGS is 30,400,000 acre feet to a depth of 300 feet, and 81,800,000 acre feet to the base of fresh groundwater (California Department of Water Resources [DWR], 2006).

Groundwater in the DMGS occurs in the Tulare Formation and overlying Quaternary and Holocene alluvium, terrace deposits and flood basin deposits. The Tulare Formation extends to a depth of over 1,000 feet, and includes beds, lenses, and tongues of clay, sand, and gravel that have been alternately deposited in oxidizing and reducing environments. It also includes a number of lacustrine clay units (DWR, 2013), the most prominent of which is known as the Corcoran Clay and acts as a regional aquitard that divides the basin fresh water deposits into an upper aquifer system that is unconfined to semi-confined, and a lower aquifer system that is confined (DWR, 2013). The Corcoran Clay is reported to occur at depths between approximately 200 and 250 feet near the Project Site, and extends from near the western margin of the subbasin to beneath the San Joaquin River. Groundwater production wells are completed in both the unconfined and confined aquifer systems; however, most high-capacity wells extend into the confined aquifer system. Domestic wells in the area are generally completed in the unconfined aquifer system.

As of 2006 (before the current drought), urban and agricultural groundwater extraction was estimated to be 508,000 AFY for the DMGS (DWR, 2006). An operational yield study by the City of Patterson estimated that the city could pump up to 12,000 AFY without significantly impacting the use of groundwater resources in the area surrounding Patterson's sphere of influence (RMC, 2016). The City of Newman pumped approximately 4,200 acre-feet of water in 2012 (Kenneth D. Schmidt and Associates [KDSA], 2013).

#### **3.4.1 Groundwater Levels and Flow**

The freshwater aquifers that are important to this study comprise approximately the upper 950 feet of sediments in this area. Groundwater levels are reported to range from approximately 30 to 50 feet bgs, and groundwater flow is generally toward the northeast, toward the San Joaquin River (DWR, 2016b). The reach of the San Joaquin River near the Site is hydraulically connected to the local shallow aquifer system

(State Water Resources Control Board [SWRCB], 2015); however, based on the depth to groundwater near the Site, it is unlikely that surface water resources and groundwater-dependent ecosystems (GDEs) in this area are connected to a regional groundwater table.

Groundwater elevation contour maps for the confined aquifer in the Site vicinity from 2011 to spring 2016 are provided as Appendix B. The contour maps show a groundwater ridge or mound persists opposite Little Salado, Salado, and Orestimba Creeks, which suggests recharge occurs along the mountain front. The contour maps show that in recent years, cones of depression have formed northwest and south of the Site, and locally influence the groundwater flow direction. The cones of depression appear most pronounced in the groundwater elevation contour maps from 2014 through 2016, particularly in the fall. This timing coincides with reductions of Central Valley Project (CVP) and State Water Project (SWP) surface water deliveries to local water providers in response to historic drought conditions (see Table 3.4.2). The cone of depression to the south is located northwest of Newman, near the northern portion of the Eastin Water District, which derives its water supply entirely from groundwater. A trend toward conversion of crop land to orchards in this area, as well as surrounding areas served by Del Puerto Water District (DPWD), was observed based on review of aerial imagery from the last 10 years (Google Earth, 2016). As such, this cone of depression may relate to an increase in pumping from the confined aquifer in response to increasing demand as the orchards matured, coupled with hardened demand that was not met from surface water deliveries.

The cone of depression to the northwest of the Site is consistent with reported groundwater pumping from the confined aquifer northwest of Patterson for irrigation purposes. Hydrogeologic conditions in this area are described in a report for the Arambel Business Park (KDSA, 2013). Groundwater pumping for irrigation from confined aquifer wells northwest of Patterson reportedly influence the groundwater flow direction (i.e., create drawdown in the confined aquifer). Most recharge in this area is associated with CVP surface water deliveries, as recharge from west side streams and rainfall is generally small. In 2010, more than half of the water applied for irrigation in this vicinity was from surface water deliveries, with the rest of the demand met from groundwater pumping. Curtailment of surface water deliveries in recent years due to drought conditions may have led to increased pumping from the confined aquifer to meet agricultural demand, while reducing a significant source of groundwater recharge. These conditions may explain the cone of depression observed northwest of the Site.

Groundwater hydrographs for several wells near the Site that are reported or assumed to be screened within the confined aquifer and for which long term hydrographs were retrieved from the DWR's California Statewide Groundwater Elevation Monitoring (CASGEM) website and are shown on Figure 3.4.1 (DWR, 2016d). Analysis of long terms hydrographs in the region south of the Site indicates that groundwater levels in the area were generally lowest in the 1940's and 1950's, increased during the 1960's and 1970's when surface water became available from the state and federal water projects, and decreased through the 1990's and 2000's, when surface water deliveries began to be curtailed for environmental reasons. Shorter term trends were identified related to periods of above or below normal precipitation. The two wells located south of the Site, near the cone of depression northwest of Newman, show a recent decreasing

trend that may relate to current drought conditions and increased groundwater pumping to replace curtailment of surface water deliveries. It is noteworthy that current groundwater levels in the well with the longest period of record (State Well No. 06S08E29J001M) are approximately 40 feet above their historical low level in October 1952. Groundwater levels in State Well No.'s 07S08D14D001M and 06S08E34M001M are at their historical low levels; however, water level data are not available for these wells prior to October 1958 and March 1959, respectively.

The hydrographs for State Well No.'s 06S08E20D002M and 06S08E09E001M span the period from 2011 to the present. In general, these hydrographs suggest that groundwater levels near the Site recovery quickly after pumping ceases, as evidenced by relatively consistent water elevations by season (see State Well No. 06S08E09E001M on Figure 3.4.1). Water levels near the Site have overall been stable over the period of record (since 2011), which indicates recent pumping rates near the Site have been sustainable on an annual basis, even during the drought.

### **3.4.2 Aquifer Properties**

DWR has estimated the average specific yield of the water-bearing sediments in the DMGS as 11.8 percent (DWR, 2006). The permeability of the shallow groundwater-bearing strata in the Site vicinity is reported by local drillers to be variable (Ward, personal communication, 2016). The rancher that currently farms the land at the Site uses three production wells (Wheeler, personal communication, 2016). Two of these wells are completed in the shallow aquifer system overlying the Corcoran Clay, to a depth of approximately 210 feet bgs. One of these shallow wells has not been a reliable groundwater producer, and the yield from this well has reportedly decreased over time. When it was originally rehabilitated by the current user and placed back into service, it reportedly produced groundwater at a rate of approximately 900 gallons per minute (gpm) at the beginning of the irrigation season, decreasing to approximately 450 gpm by the end of the irrigation season. However, the yield from this well has reportedly decreased from year to year, and in 2015, this well reportedly did not produce a significant amount of groundwater. The second shallow well is reliably pumped continually throughout the irrigation season; however, the well yield typically decreases from approximately 1,400 gpm at the beginning of the season to approximately 400 gpm at the end of the season. The third existing well at the Site is completed to a depth of approximately 495 feet bgs, with two screened intervals. This well has consistently produced groundwater at a rate of approximately 900 gpm throughout the irrigation season, suggesting that most or all of the groundwater pumped from this well is derived from the confined aquifer below the Corcoran Clay. The rancher that currently farms the land indicated that the water quality from this well is distinct from the other two shallow wells, and contains more boron. This observation would be consistent with most of the water from this well coming from the confined aquifer.

Estimated transmissivities are available for seven wells near Patterson to the north of the Site, and seven wells near Newman, southwest of the Site (KDSA, 2010 and 2013). These 14 wells are reportedly screened entire within the confined aquifer, or in the confined and shallow aquifer ("composite" wells). In addition, specific capacity tests for two nearby confined aquifer wells were evaluated by Stanislaus County



Department of Environmental Resources and the results provided to JJ&A. An evaluation of aquifer parameters based on these tests is presented in Table 3.4.1. The estimated hydraulic conductivity for the confined and composite aquifers ranged from 13 to 117 feet per day (ft/day), with a geometric mean of 45 ft/day and a 10<sup>th</sup> percentile value of 17 ft/day. By comparison, results from a 72-hour pumping test Patterson City Well No. 7 yielded an average hydraulic conductivity for the confined aquifer of 40 feet/day (KDSA, 2013).

The vertical hydraulic conductivity of the Corcoran Clay near the site is not known, but a reasonable range based on the literature is approximately 6.2 E-04 to 3.0 E-06 ft/day (USGS, 2009; USGS, 2004).

The storativity of the confined aquifer from the Patterson City Well No. 7 pumping test was 0.0003 (KDSA, 2013). This is similar to the results of a pumping test conducted by Kleinfelder at a similar location approximately 12 miles to the north, which was 0.0001 (Kleinfelder, 2016).

**Table 3.4.1 Aquifer Properties Estimated from Specific Capacity Tests**

Well	Screen Aquifer	Screen Interval Span (feet)	Reported Specific Capacity (gpm/ft)	Estimated Transmissivity (gpd/ft <sup>2</sup> )	Estimated K for Screen Interval Span (ft/day)
Patterson City Well 2	Composite	190	42	71,400	50
Patterson City Well 4	Composite	225	19	32,300	19
Patterson City Well 5	Confined	175	42	84,000	64
Patterson City Well 6	Composite	130	15	25,500	26
Patterson City Well 7	Confined	267	21	42,000	21
Patterson City Well 8	Confined	140	59	118,000	113
Patterson City Well 11	Confined	220	45	90,000	55
Newman City Well 2	Composite	247	77	130,900	71
Newman City Well 3	Composite	270	65.1	110,670	55
Newman City Well 4	Composite	322	77.8	132,260	55
Newman City Well 13	Composite	315	92.1	156,570	66
Newman City Well 36	Composite	303	32.9	55,930	25
Newman City Well 42	Composite	301	64.2	109,140	48
Newman City Well 53	Composite	300	51.3	87,210	39
6S/8E-6Q (WCR#788583)	Confined	180	20.9	41,800	31
6S/8E-21R(WCR#82200)	Confined	190	9.4	18,800	13

### 3.4.3 Groundwater Quality

Generally, groundwater quality in the basin is suitable for most urban and agricultural uses, with primary constituents of concern consisting of total dissolved solids (TDS), nitrate, boron, chloride, and organic compounds (DWR, 2003). Areas of high TDS concentrations are primarily found in the western region of the valley, due to the recharge of streamflow originating from the marine sediments in the nearby Coast

Ranges, while high concentrations of boron are typically found in the valley trough as the results of salts, due to evaporation and poor drainage (DWR, 2003). Sulfate and boron concentrations vary in both the shallow and confined aquifers, with slightly higher boron concentrations in the confined aquifer; there is little difference in arsenic concentrations between the shallow and confined aquifers. Nitrate, nitrite, hexavalent chromium, and 1,2,3-trichloropropane have been detected at concentrations above the Maximum Contaminant Levels (MCL) in groundwater from the Crows Landing Community Services District area surrounding the Site (AECOM and VVH Consulting Engineers, 2016).

The Navy maintains a 2,000 foot pumping restriction at the Crows Landing Air Facility around a contamination plume known as the IRP Site 17 Administration Area Plume (see Figure 2.1.1) (AECOM and VVH Consulting Engineers, 2016). The contamination plume is the result of underground fuel storage tanks, used for the former facility, and includes benzene and other volatile organic compounds. The plume contaminants appear to be limited to the shallow aquifer, above the Corcoran Clay.

#### **3.4.4 Groundwater Budget and Existing Groundwater Demand**

Development of a complete groundwater budget and demand inventory is beyond the scope of this study; however, the following information is pertinent to this analysis. DWR has listed the DMGS as being in a state of overdraft, though groundwater levels in the vicinity of the Site are generally stable (Section 3.4.1). A study of groundwater level trends from 1993 to 2008 found that groundwater levels in northern portions of the DMGS were generally hydrologically balanced (AECOM, 2011). The study found minimal apparent net change in groundwater elevations, which were interpreted as equilibrium between use and recharge. However, consistent declines in groundwater levels in certain localized areas (including an area west of Newman), may be indicative of a developing local overdraft condition. This is consistent with groundwater elevation contours and hydrographs for the Site vicinity, as discussed in Section 3.4.1.

Land use overlying the DMGS near the Site is primarily agricultural, with local agricultural water demand served by surface-water deliveries from DPWD, supplemented by groundwater extraction. Municipal water demand for the Cities of Patterson and Newman, as well as the community of Crows Landing, is met using groundwater. Demand forecasts are available for the City of Patterson from the 2015 update to its Urban Water Management Plan (UWMP) (RMC, 2016). The demand is projected to increase from 6,376 AFY in 2020 to 11,801 AFY in 2040. Similar proportional increases in demand may also be expected in the communities of Newman and Crows Landing if they follow similar population and development trends. However, it is important to note that increased municipal demand would be expected to be offset by a corresponding decrease in agricultural demand associated with conversion of agricultural land to municipal use.

Groundwater demand for agricultural production at the Site has historically been met through a combination of groundwater pumping and surface deliveries from DPWD. Information regarding the total applied water volumes and groundwater pumpage for on-Site wells for the last five years was provided by the rancher that farms the property and is summarized in Table 3.4.2, below.

**Table 3.4.2 Historical Site Groundwater Pumpage and Surface Water Deliveries**

Year	Volume of Groundwater Extracted (acre-feet) <sup>1</sup>			Volume of Surface Water Delivered (acre-feet) <sup>2</sup>	Percent of CVP Contract Allotment Available <sup>2</sup>	Total Applied Water (acre-feet)
	Deep Well	Shallow Wells	Total			
2012	380	560	940	1,629	40%	2,569
2013	402	448	850	424	20%	1,274
2014	390	212	602	158	0%	760
2015	564	378	942	0	0%	942
Average	434	400	834	553	15%	1,386

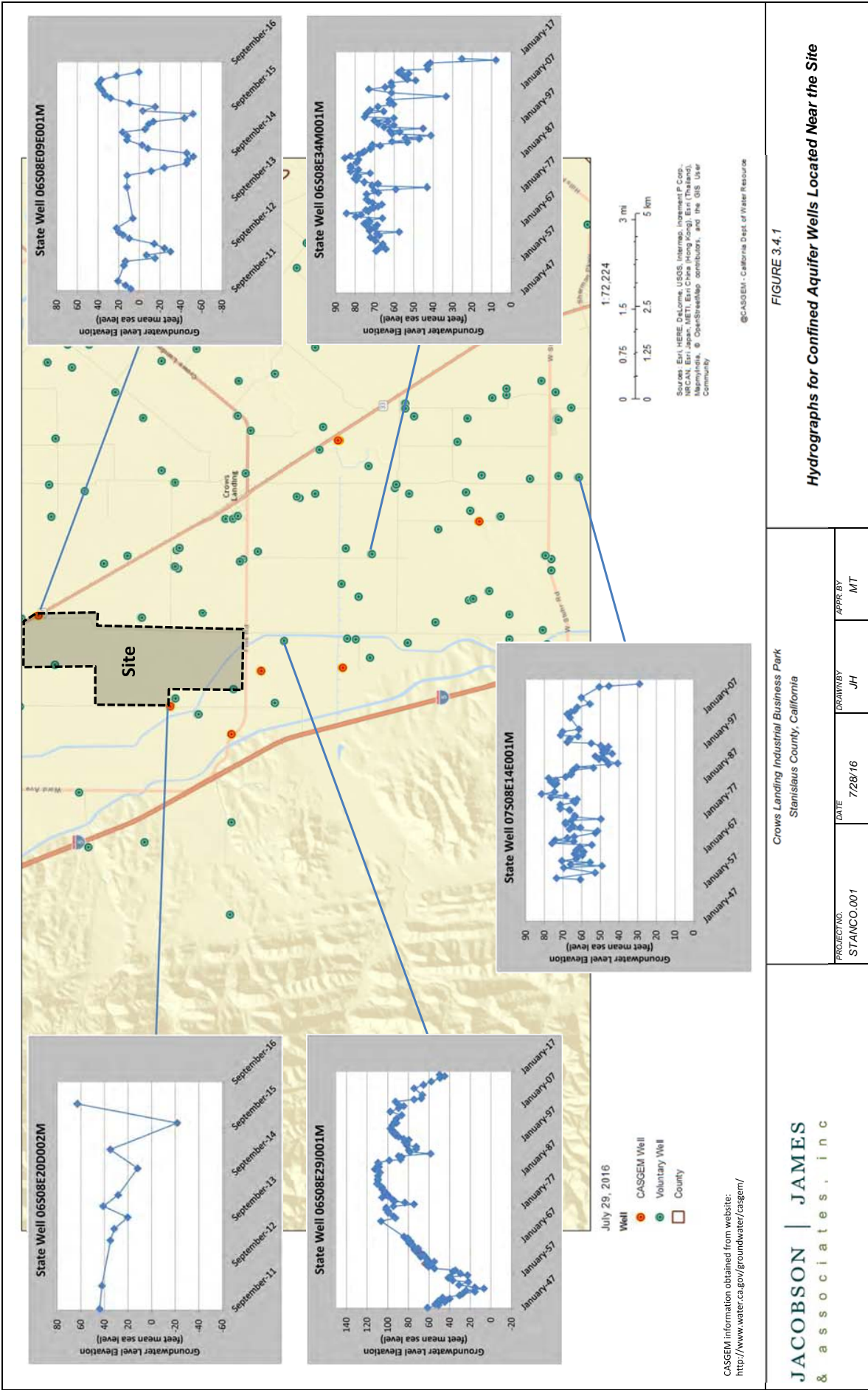
1. Based on information reported in AECOM, 2016 or data provided by Wheeler, 2016. Where conflicting data were provided, extraction volumes reported in AECOM, 2016 were utilized and divided among the wells in proportion to reported pumping rates.

2. Taken from Water Use Statements from Del Puerto Water District provided by Wheeler, 2016.

### 3.5 Subsidence

Land subsidence can occur when compressible clays are depressurized as a result of groundwater extraction, triggering water to flow from the clays into the surrounding aquifer, and ultimately consolidation of the clay under pressure from the overlying sediments. This can happen especially in confined aquifer conditions such as below the Corcoran Clay, where the head loss resulting from groundwater extraction is greater than in unconfined aquifers. The process of subsidence is reversible when granular aquifer materials compress and expand under changing pressure conditions, but irrecoverable when clay frameworks are compressed and reoriented. Irrecoverable subsidence results in decreased storage capacity within the aquifer. In general, most subsidence occurs when an aquifer is initially depressurized, but can continue for months, or even years, after clays slowly dewater and adjust to the new pressure regime. If groundwater levels subsequently recover, subsidence generally does not resume (or does not progress as rapidly), until groundwater levels fall below historical low levels.

DWR has included the DMGS on the list of critically overdrafted basins, largely due to overdraft and subsidence reported outside Stanislaus County to the south (DWR, 2016a); nevertheless DWR has designated the entire DMGS as having a high potential for future subsidence (DWR, 2016b). The Bureau of Reclamation, in cooperation with DWR, monitors a geodetic survey network of triangulated elevation monitoring of benchmarks in the area surrounding the San Joaquin River from Fresno to Patterson, including locations along the Delta-Mendota Canal (U.S. Bureau of Reclamation [USBOR], 2014). Survey data from this program indicate a subsidence rate of 0 to 0.15 feet (0 to 1.8 inches) per year from December 2011 to December 2015 near the Site, including areas surrounding Patterson and Newman (USBOR, 2016). More rapid short-term subsidence rates were reported from December 2012 through December 2013, ranging from 0.15 to 0.3 feet per year (USBOR, 2014). This is consistent with DWR’s report of 1 to 2.5 inches of subsidence from 2005 to the present at continuous survey station P259, located near the northeast corner of the Site at the intersection of Marshall Road and State Highway 33 (DWR, 2016b).



## 4.0 EVALUATION OF HYDROGEOLOGIC EFFECTS

To evaluate the potential effects of the CLIBP on groundwater resources, an analytical groundwater modeling study was performed to assess the potential impacts of pumping on groundwater levels at the Site and in the surrounding area under a range of scenarios that bracket the current uncertainty regarding aquifer conditions. The analytical modeling study was based on the conceptual understanding described in Section 4.1, and implemented as described in Section 4.2. The results are presented in Section 4.3.

### 4.1 Conceptual Understanding

The modeling study is based on the following working conceptual understanding of groundwater occurrence and flow in the vicinity of the Site:

- Bedrock of the Diablo Range, located approximately 1 to 2 miles west of the Site, forms a no-flow boundary for the alluvial aquifers underlying the DMGS.
- In the Site area, groundwater occurs in a two-aquifer system, including an upper unconfined aquifer and a lower confined aquifer. These two aquifers are separated by the Corcoran Clay, a regionally extensive aquitard that occurs at a depth of approximately 250 feet bgs, with an average thickness of approximately 70 feet, based on data provided by Stanislaus County.
- The base of freshwater aquifers in this area is reported to occur at an elevation of approximately 800 feet below sea level (approximately 950 feet bgs) (Page, 1973). The confined aquifer system available for development by the CLIBP is therefore assumed to extend from approximately 320 to 870 feet bgs, for a total thickness of approximately 550 feet.
- Mountain front recharge occurs near the western edge of the subbasin, where streams draining the Diablo Range emerge onto small alluvial fans at the edge of the valley. The Corcoran Clay may be absent or discontinuous in this area (AECOM, 2011), so it is possible that some recharge percolates directly into the confined aquifer in this area.
- Regional groundwater flow is toward the northeast, away from the Diablo Range and toward the San Joaquin River, approximately 4 to 6 miles east of the Site (see Appendix B). This flow pattern has been locally disrupted by cones of depression located north and south of Site vicinity, which have expanded since 2013 during drought conditions.
- In the vicinity of the Site, groundwater levels have consistently recovered each year after the irrigation season, and a recurrent groundwater mound at the mountain front near Little Salado Creek and Salado Creek suggests a persistent inflow of recharge from this area restores groundwater levels and the prevalent flow direction in this area (see Figure 3.4.1 and Appendix B). This suggests that groundwater recharge and discharge are generally balanced in this area.
- Groundwater levels along the mountain front west of the Site are reported to be approximately 110 feet bgs near Crow Creek (southwest of the Site), and decreasing to approximately 30 feet bgs near

Del Puerto Creek (northwest of the Site), where a cone of depression appears to have formed during recent drought years (see Appendix B).

- Groundwater levels near the San Joaquin River are generally close to the elevation of the river, suggesting that this reach of the river is hydraulically connected with the shallow aquifer. Groundwater contours near the river suggest that shallow groundwater is discharging to the river, especially in the area to the southeast of the Site.
- Transmissivity data from municipal wells in Patterson and Newman that are screened within the confined aquifer indicate the lateral hydraulic conductivity ranges from 19 to 113 ft/day (see Table 3.4.1). Hydraulic conductivity calculations based on these data indicate a mean of 47 ft/day, a geometric mean of 41 ft/day, and a 10<sup>th</sup> percentile of 17 ft/day. The hydraulic conductivity is assumed to be the same in the shallow and confined aquifers.
- Pumping test data from Patterson City Well No. 7 and an irrigation well located in a similar setting approximately 12 miles to the north indicate the storativity of the confined aquifer ranges from 0.0001 (Kleinfelder, 2016) to 0.0003 (KDSA, 2013). The storativity in the Corcoran Clay is assumed to be the same as for the confined aquifer. The storativity in the shallow aquifer near the Site is not known, but a reasonable value based on our experience is approximately 0.04.
- DWR (2006) estimated the specific yield for the DMGS to be 11.8; this value was used for the shallow and confined aquifers.
- The vertical hydraulic conductivity of the Corcoran Clay near the site is not known, but a reasonable range based on the literature is approximately 1.0 E-04 to 3.0 E-06 ft/day (USGS 2004 and 2009).

## 4.2 Analytical Drawdown Model

### 4.2.1 Approach

An analytical model was constructed to evaluate the reasonable range of drawdown that could occur from groundwater extraction related to development of the CLIBP. The model was constructed using the AnAqSim modeling code (Fitts Geosolutions, 2016), a three-dimensional (multi-layer) analytical element modeling code capable of simulating groundwater flow to wells under confined, unconfined, or semi-confined aquifer conditions. AnAqSim is able to simulate a variety of boundary conditions (e.g., no-flow, constant flux, variable flux, general head, and constant head), line or area sources and sinks (e.g., rivers and recharge), and flow barriers. AnAqSim can be used to simulate transient conditions as a result of pumping from single or multiple wells at constant or varying rates, and calculates the head and discharge as functions of location and time across a designated model grid or at designated points.

Four modeling scenarios were developed using a superposition approach to simulate drawdown under a reasonable range of conditions. Superposition or impact modeling is a robust modeling approach which focuses on evaluation of drawdown as opposed to actual hydraulic head, and allows the modeler to focus more on the evaluation of the changes introduced by a project, rather than the simulation of past or future groundwater levels (Reilly, Franke and Bennett, 1987). The use of superposition modeling in hydrogeologic

literature is well established and this approach has been widely used to evaluate the impacts of water supply pumping.

For each of the modeling scenarios, a baseline model was constructed to simulate a set of aquifer conditions representing reasonable end point assumptions. The model was then run in transient mode with simulated pumping from the project wells, and resulting water level surface was subtracted from the baseline to evaluate the drawdown induced by the project at the end of Phase 1, Phase 2 and Phase 3 of the Project. The model inputs and supporting rationale are discussed below and summarized in Table 4.2.1. The model domain and boundaries are shown graphically in Figure 4.2.1, and model layering is shown in Figure 4.2.2.

**Model Domain and Layering.** For this evaluation, a model domain was established that measures approximately 75,000 by 50,000 feet that is approximately centered on the Site. The model domain was divided into two subdomains. The eastern subdomain includes three layers representing the shallow unconfined aquifer, the Corcoran Clay, and the lower confined aquifer. The western subdomain consists of a narrow strip on the west side of the model domain (the “forebay”), which was constructed as a single layer separated from the rest of the model domain by an inter-domain boundary; the forebay represents mountain-front sediments where the Corcoran Clay may or may not be present as a confining layer. The San Joaquin River was incorporated into the model with a direct connection to the shallow aquifer subdomain. Spatially-variable area sink/source polygons were constructed to model groundwater recharge around the San Joaquin River and groundwater extraction from the three assumed new confined aquifer wells at the CLIBP. This approach was selected because the software and domain configuration allow for modeling of drawdown in any of the subdomains (the focus is on the confined aquifer) at different phases of Project buildout with the ability to vary aquifer characteristics and boundary conditions that bracket the current uncertainty regarding aquifer conditions.

**Boundary Conditions.** General head boundaries were simulated on north, east, and south the east sides of the model domain. General head conditions were selected based on groundwater elevations from contour maps for the project vicinity (Appendix B). The western boundary of the model domain was simulated in two different ways to bracket the current uncertainty regarding the persistence of the Corcoran Clay in this area (see Figure 4.2.2):

- In Scenarios 1 and 2, the western boundary of the forebay was defined as a no-flow boundary along the mountain front, with surface recharge to the forebay. For these scenarios, the forebay subdomain was extended to a depth of 300 feet bgs, and water was allowed to flow laterally directly from the forebay into the Corcoran Clay and the lower confined aquifer (direct recharge condition).
- In Scenarios 3 and 4, the western boundary of the forebay was defined as a constant head boundary, with the assigned heads based on average historical groundwater elevations along the western margin of the basin over the last five years (Appendix B). For these scenarios, the depth of the forebay subdomain was identical to the shallow aquifer depth, and lateral groundwater flow was allowed from the forebay only into the shallow aquifer. Under these scenarios, the only path

by which mountain front recharge may enter the lower confined aquifer is via percolation through the Corcoran Clay (no direct recharge condition).

**Line Sinks.** The San Joaquin River was simulated as a line sink with direct connection to the shallow aquifer. The river stage was set based data from USGS gaging stations “SMN” (San Joaquin River above the Merced River near Newman) and SCL (San Joaquin River near Crows Landing) (DWR, 2016c).

**Aquifer Characteristics.** The aquifer was modeled as a 3-layer domain with the Corcoran Clay as a leaky confining layer. Aquifer transmissivity and storativity, and confining layer vertical hydraulic conductivity, were assigned a reasonable range of values based on the information discussed in Section 3, as summarized in Table 4.2.1, below. Assigned values for horizontal hydraulic conductivity ranged from a maximum of 40 ft/day (the value derived from the City of Patterson pumping test) to 17 ft/day (the 10<sup>th</sup> percentile hydraulic conductivity derived from the analysis of specific capacity data presented in Table 3.4.1).

**Pumping.** Pumping was simulated to occur from three wells installed as shown on Figure 4.2.1. Pumping was assumed to be equally distributed among the three wells. Pumping was modeled to occur only in the confined aquifer over a thickness of 550 feet, encompassing the sediments extending vertically from the base of the Corcoran Clay to approximately 80 feet above the reported base of fresh water. The total pumping for each project development phase was based upon the net increase in potable groundwater demand at the end of each buildout phase, compared with the pre-development condition, as summarized in Table 4.2.1, below.

**Table 4.2.1 Analytical Model Input Parameters**

Model Input Parameter		Input Data Value				Data Source
		Shallow Aquifer	Corcoran Clay	Confined Aquifer	Forebay	
Aquifer Thickness (feet)		250	70	550	250 to 400	Section 3.4
Storativity		0.04	0.0001 to 0.0003	0.0001 to 0.0003	0.004	Section 3.4.2
Specific Yield		11.8	0.0001 to 0.0003	11.8	11.8	Section 3.4.2
Hydraulic Conductivity, Horizontal (ft/day)		17 to 40	0.0003 to 0.001	17 to 40	17 to 40	Table 3.2.1
Hydraulic Conductivity, Vertical (ft/day)		1	0.000003 to 0.0001	1	1	Fetter, 1994
Net Pumping Rate (AFY)	Phase 1 (2017 to 2026)	0	0	739	NA	Table 2.2.1
	Phase 2 (2027 to 2036)	0	0	1,036	NA	Table 2.2.1
	Phase 3 (2037 to 2046)	0	0	1,496	NA	Table 2.2.1



**4.2.2 Model Inputs**

The analytic element model’s input parameters are summarized in the Table 4.2.1 above. The model assumes all pumping is from the confined aquifer to meet the increased demand for potable water, and that there is no net increase in groundwater demand from the shallow aquifer.

**4.2.3 Model Scenarios**

As with any predictive modeling study, uncertainty in the model inputs will affect the reliability of the results. Therefore, four modeling scenarios were developed in order to address a reasonable range of possible outcomes, thus bracketing the likely effects of the Project. These scenarios are described in Table 4.2.2, below. For each scenario, drawdown is evaluated at the full buildout of each construction phase (i.e., after 10, 20, and 30 years).

**4.2.2 Analytical Modeling Scenarios**

Parameter	Scenario 1	Scenario 2	Scenario 3	Scenario 4
Direct Recharge to Confined Aquifer from Forebay	✓	✓		
No Direct Recharge to Confined Aquifer from Forebay			✓	✓
Best Case Aquifer Parameters <sup>1</sup>	✓		✓	
Worst Case Aquifer Parameters <sup>2</sup>		✓		✓

<sup>1</sup> Confined aquifer storativity of 0.0003 and horizontal hydraulic conductivity of 40 ft/day; Corcoran Clay storativity and specific yield of 0.0003, horizontal hydraulic conductivity of 0.001 ft/day, and vertical hydraulic conductivity of 0.0001 ft/day.

<sup>2</sup> Confined aquifer storativity of 0.0001 and horizontal hydraulic conductivity of 17 ft/day; Corcoran Clay storativity of 0.0001, specific yield of 0.000003, horizontal hydraulic conductivity of 0.0003 ft/day, and vertical hydraulic conductivity of 0.000003 ft/day.

**4.2.4 Assumptions and Limitations**

This section presents hydrogeologic assumptions that are incorporated in the analytical element model.

- The aquifer layers have a uniform lateral and vertical hydraulic conductivities, and uniform specific yield and storativity. This is a typical simplifying assumption inherent in many models, and is appropriate as long as the objective is to model the general distribution of impacts under average conditions.
- The potentiometric surface is approximated through the use of boundary conditions and is not calibrated. This is simplifying assumption used in many models that are designed to evaluate drawdown relative to a baseline condition using a superposition approach. The inherent limitation in this approach is that the model cannot be used to predict actual groundwater level elevations. In

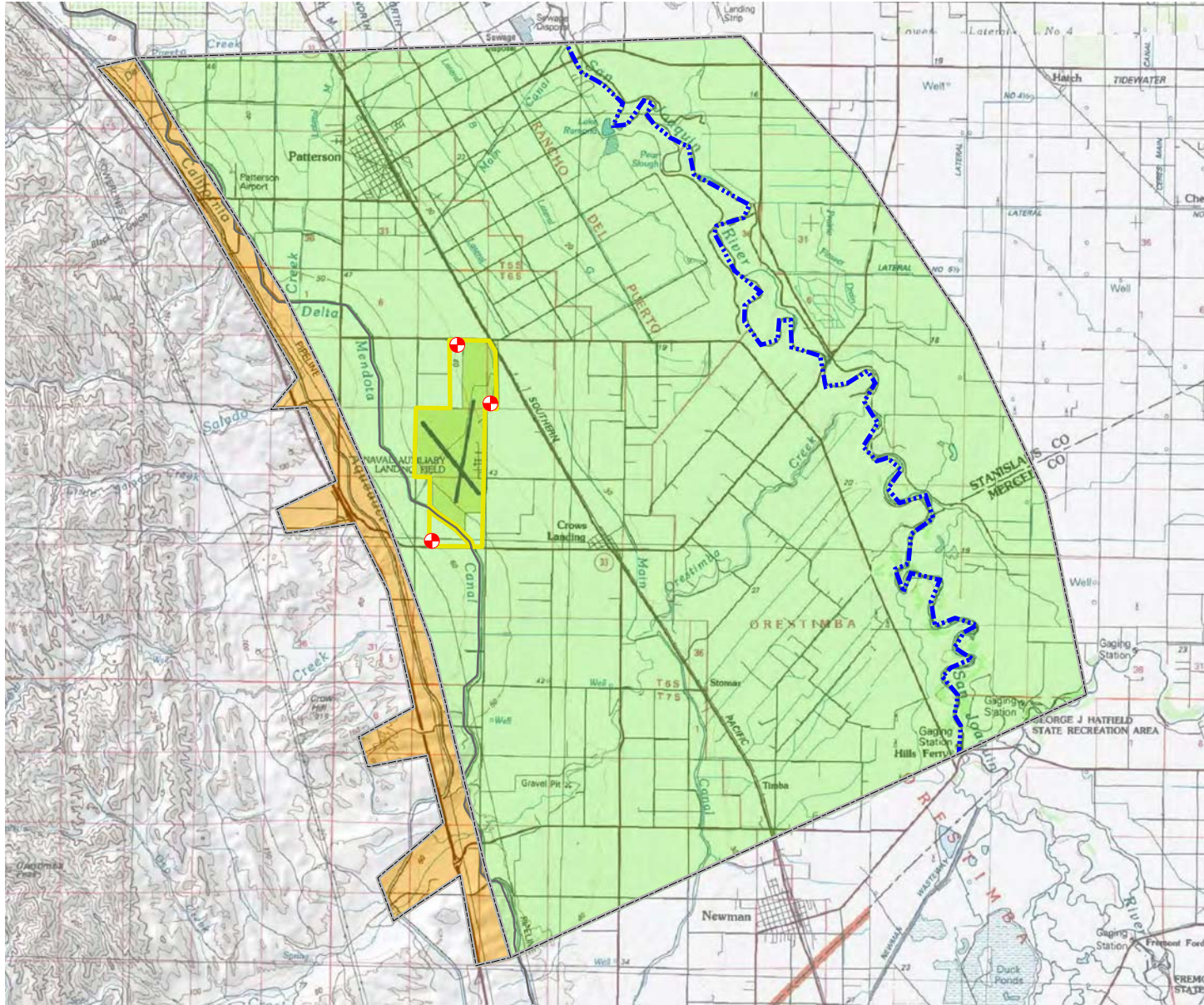
addition, the modeled drawdown may be considered an approximation. The impact of these limitations is lessened through the use of range of boundary and aquifer conditions.

- Water is released from storage in the aquifers instantaneously, the pumping well is screened in, and receives water from, the full thickness of the aquifer, and the well is 100 percent efficient.
- Areal recharge and pumping discharge (with exception of the Project) are assumed to be balanced and are therefore neglected in the simulation. This assumption is supported by the generally stable groundwater levels in the Site vicinity.
- Mountain front recharge, underflow in, underflow out, and river discharge are balanced and simulated using boundary conditions, line sinks and areal flux in the forebay subdomain.

### 4.3 Results

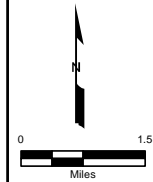
The distribution of drawdown predicted for each of the four scenarios is shown at the buildout of Project Phase 1, 2 and 3 on Figures 4.3.1, 4.3.2, and 4.3.3, respectively, and key findings are summarized in Table 4.3.1. Predicted drawdown in the confined aquifer is greatest under Scenario 4 and least under Scenario 1. Predicted drawdown is more sensitive to the modeled difference in aquifer parameters than to the different recharge conditions that were evaluated. Key findings from the predictive modeling are summarized below:

- Drawdown is predicted to stabilize quickly for each stress period, generally within a year.
- The maximum predicted drawdown in the confined aquifer ranges from:
  - 2 to 7 feet at completion of Phase 1 buildout;
  - 3 to 10 feet at completion of Phase 2 buildout; and,
  - 4 to 14 feet at completion of Phase 3 buildout
- The maximum predicted drawdown in the confined aquifer beneath the Delta-Mendota Canal ranges from:
  - 1 to 6 feet at completion of Phase 1 buildout;
  - 2 to 9 feet at completion of Phase 2 buildout; and,
  - 3 to 13 feet at completion of Phase 3 buildout
- The predicted drawdown in the confined aquifer at completion of Phase 3 buildout ranges from 2 to 7 feet near the city of Patterson and from approximately 1 to 4 feet beneath the city of Newman. This suggests that drawdown related to Project pumping would contribute slightly to the cones of depression northwest and south of the Site, but the Project-related drawdown will be in the range of 1 to 10 percent of the total drawdown observed in these areas to date (on the order of 50 to 100 feet based on fall 2015 data; see Appendix B).
- Predicted drawdown in the shallow aquifer from new pumping in the confined aquifer will be negligible.



**LEGEND**

- Assumed Location of Confined Aquifer Well
- Site location
- San Joaquin River Line Sink
- East Subdomain (Shallow Aquifer, Corcoran Clay and Confined Aquifer)
- West Subdomain (Forebay)



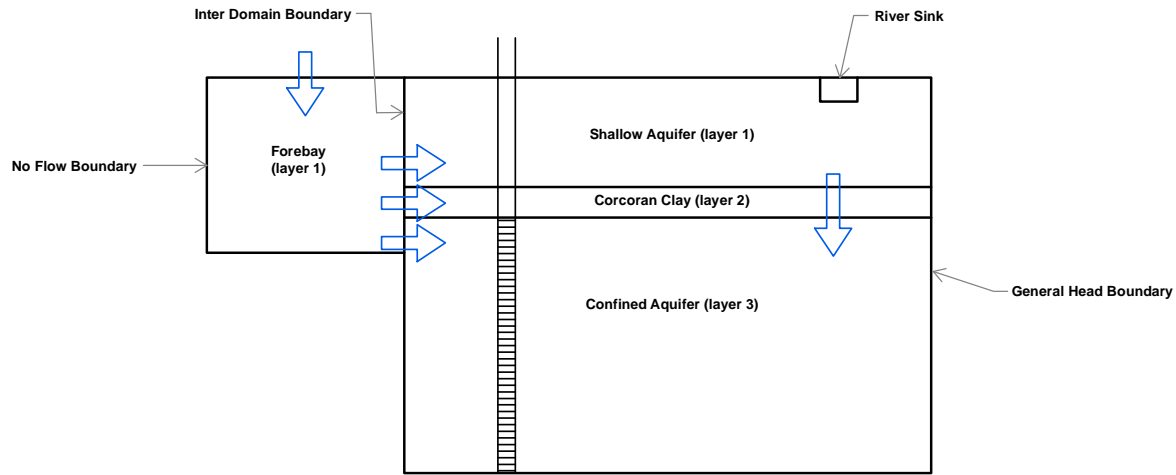
**JACOBSON | JAMES**  
& associates, inc

**TITLE**  
**MODEL DOMAIN BOUNDARIES AND FEATURES**

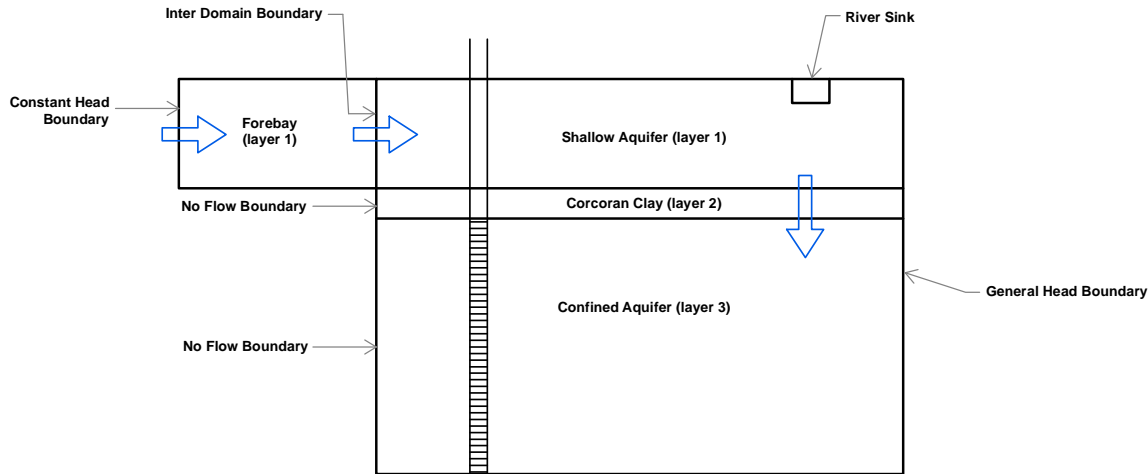
**CROWS LANDING INDUSTRIAL BUSINESS PARK  
STANISLAUS COUNTY, CALIFORNIA**

DRAWN BY	APPROVED BY	DATE	FIGURE
DPG	JB	8/2/16	<b>4.2.1</b>

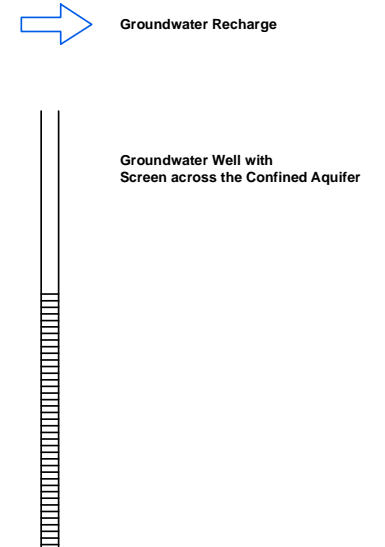
### SCENARIOS 1 and 2



### SCENARIOS 3 and 4



#### LEGEND

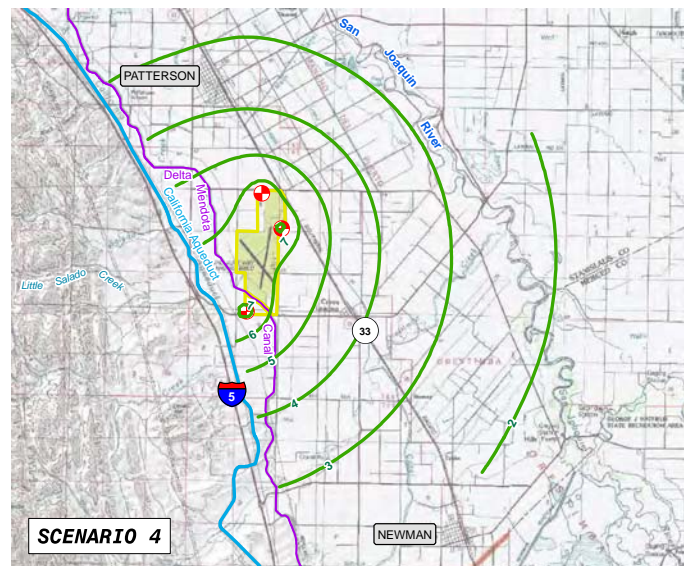
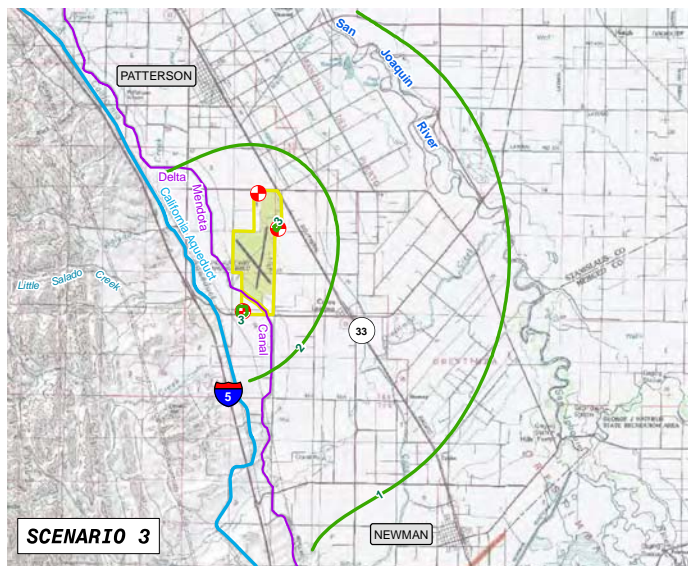
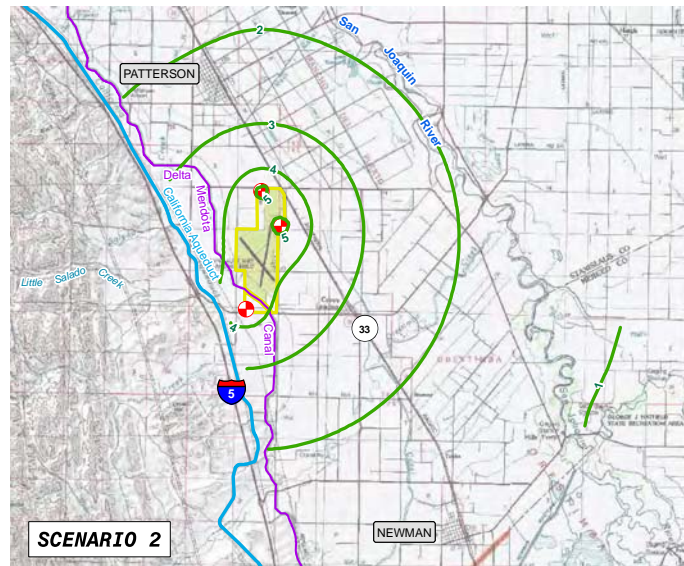
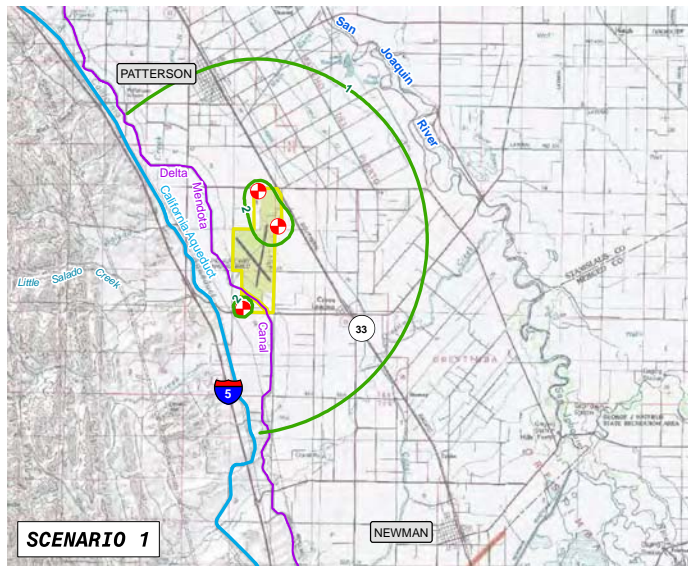


**JACOBSON | JAMES**  
& associates, inc




TITLE  
**CONCEPTUAL ILLUSTRATION  
OF MODEL CONSTRUCTION**

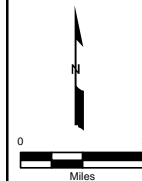
**CROWS LANDING INDUSTRIAL BUSINESS PARK  
STANISLAUS COUNTY, CALIFORNIA**

DRAWN BY	APPROVED BY	DATE	FIGURE
DPG	JB	8/1/16	<b>4.2.2</b>



**LEGEND**

-  Assumed Location of Confined Aquifer Well
-  Contour for Predicted Groundwater Drawdown (1-foot intervals)
-  Site Boundary

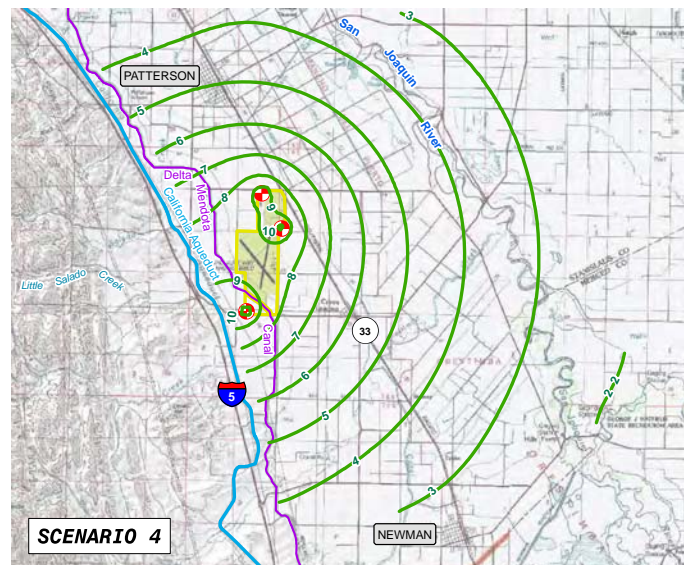
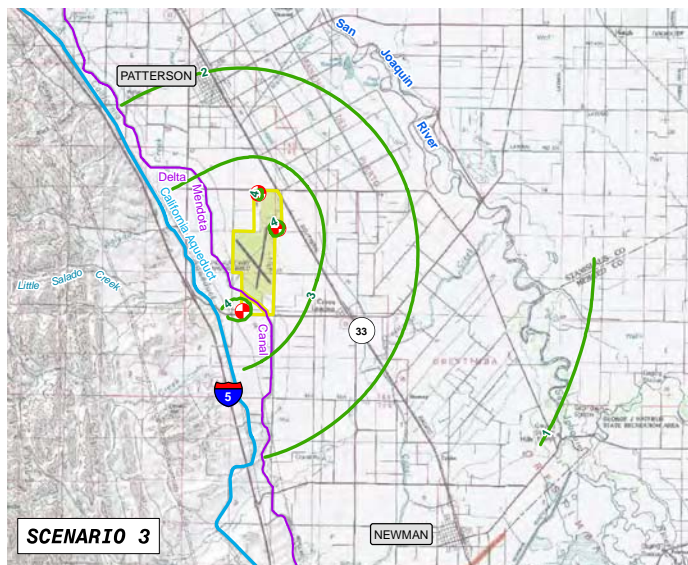
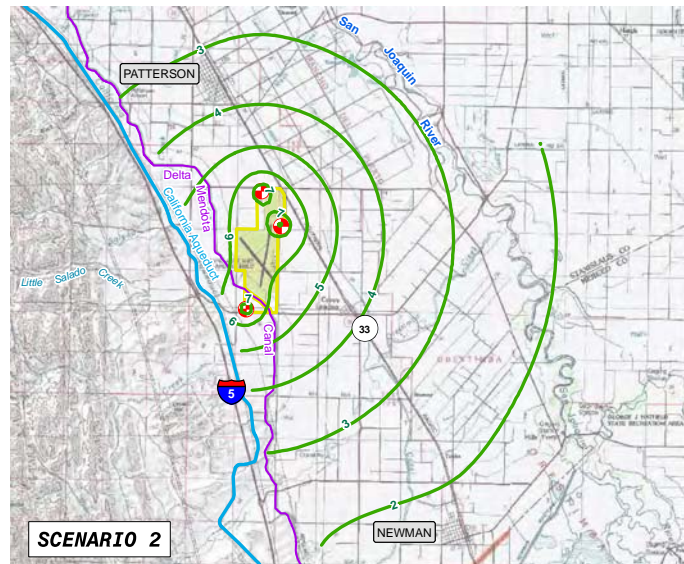
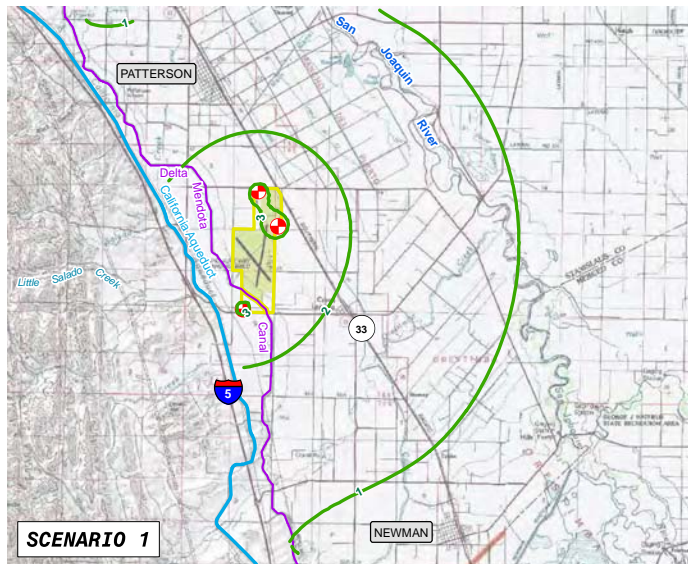


**JACOBSON | JAMES**  
 & associates, inc

**TITLE**  
 PREDICTED DRAWDOWN IN THE CONFINED  
 AQUIFER FOR SCENARIOS 1 THROUGH 4  
 END OF PHASE 1

**CROWS LANDING INDUSTRIAL BUSINESS PARK  
 STANISLAUS COUNTY, CALIFORNIA**

DRAWN BY	APPROVED BY	DATE	FIGURE
DPG	JB	8/1/16	<b>4.3.1</b>



**LEGEND**

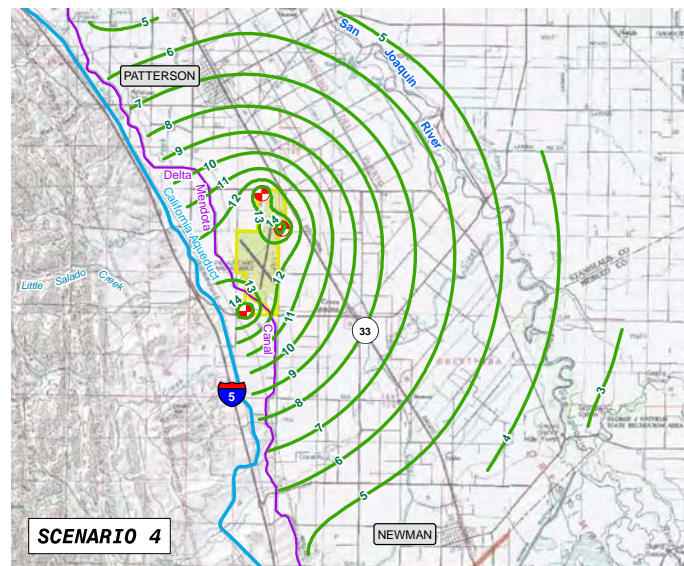
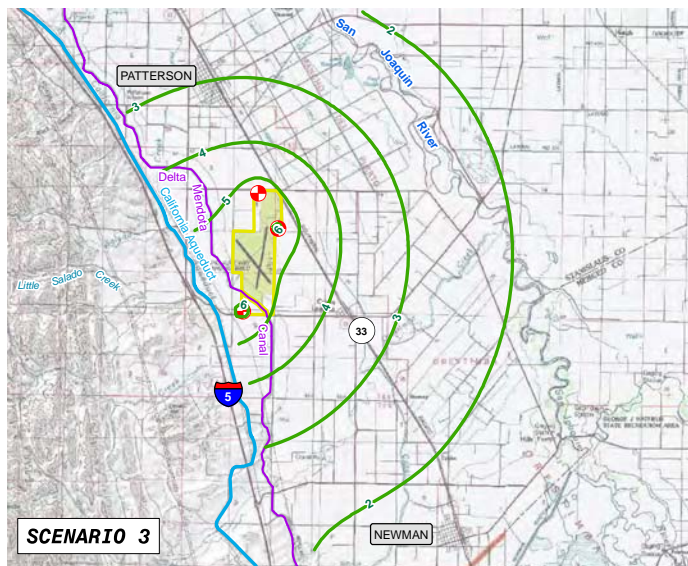
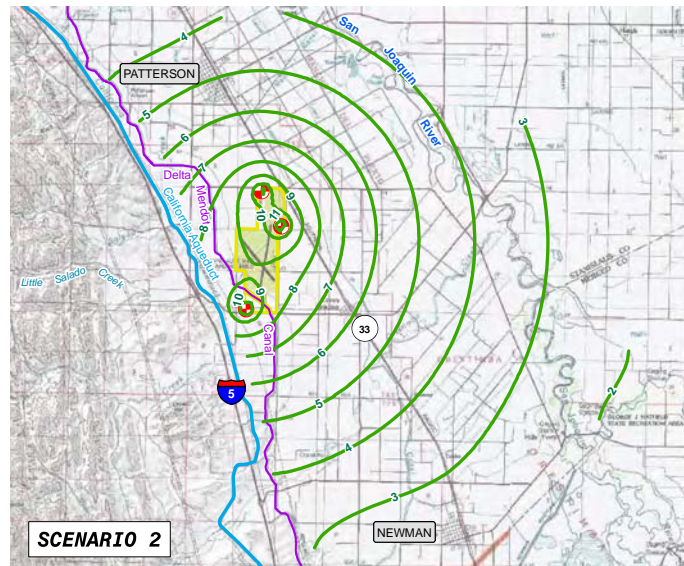
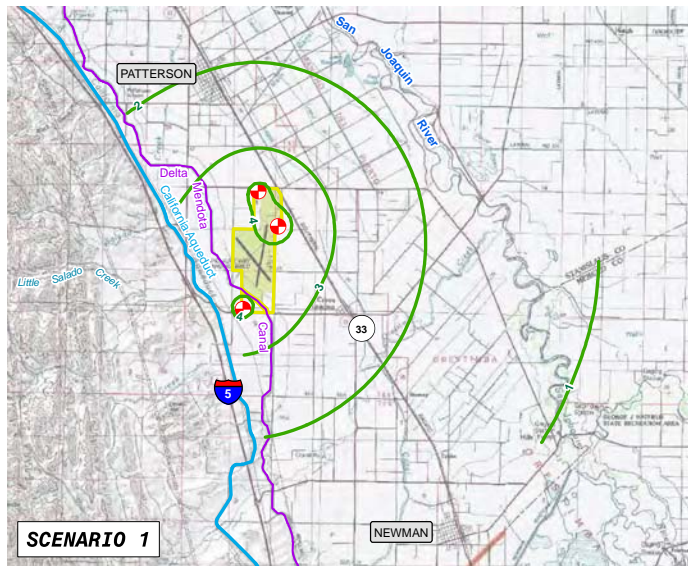
- Assumed Location of Confined Aquifer Well
- Contour for Predicted Groundwater Drawdown (1-foot intervals)
- Site Boundary

**JACOBSON | JAMES**  
 & associates, inc




**TITLE**  
 PREDICTED DRAWDOWN IN THE CONFINED  
 AQUIFER FOR SCENARIOS 1 THROUGH 4  
 END OF PHASE 2

**CROWS LANDING INDUSTRIAL BUSINESS PARK  
 STANISLAUS COUNTY, CALIFORNIA**

DRAWN BY	APPROVED BY	DATE	FIGURE
DPG	JB	8/1/16	<b>4.3.2</b>



**LEGEND**

-  Assumed Location of Confined Aquifer Well
-  Contour for Predicted Groundwater Drawdown (1-foot intervals)
-  Site Boundary

**JACOBSON | JAMES**  
 & associates, inc

**TITLE**  
 PREDICTED DRAWDOWN IN THE CONFINED  
 AQUIFER FOR SCENARIOS 1 THROUGH 4  
 END OF PHASE 3

**CROWS LANDING INDUSTRIAL BUSINESS PARK  
 STANISLAUS COUNTY, CALIFORNIA**

DRAWN BY	APPROVED BY	DATE	FIGURE
DPG	JB	8/1/16	<b>4.3.3</b>

## 5.0 IMPACT EVALUATION

This section presents an evaluation of the potential environmental impacts of the Project associated with groundwater resources. The impact evaluation is provided in the form of reasoned evaluations in answer to each of the applicable significance questions contained in Appendix G of the CEQA Guidelines, listed below. The questions are grouped by topic based on the “undesirable results” defined in the County Groundwater Ordinance and the California Water Code. As such, the evaluation also provides substantial evidence whether or not the proposed new wells to be installed for the Project comply with the prohibition against unsustainable extraction contained in the County Groundwater Ordinance. An additional section is added to discuss water supplies and entitlements, which are a topic under CEQA that is not included in the Groundwater Ordinance.

### 5.1 Groundwater-Dependent Ecosystems

**Question IV(a): Would the project have a substantial adverse effect, either directly or through habitat modifications, on any species identified as a candidate, sensitive, or special status species in local or regional plans, policies, or regulations, or by the California Department of Fish and Game or U.S. Fish and Wildlife Service?**

**Question IV(b): Would the project have a substantial adverse effect on any riparian habitat or other sensitive natural community identified in local or regional plans, policies, regulations, or by the CDFG or USFWS?**

**Question IV(c): Would the project have a substantial adverse effect on a federally protected wetlands as defined by Section 404 of the Clean Water Act (including marsh, vernal pool, coastal, etc.) through direct removal, filling, hydrological interruption, or other means?**

Groundwater near the site occurs at depths of at least 30 feet or more beneath the ground surface, so wetlands identified in the Site vicinity are not connected to the regional water table. Further east, wetlands and riparian vegetation near the San Joaquin River may be groundwater connected; however, pumping from the confined aquifer is predicted to produce negligible drawdown in this area. The project will not result in any net increase in groundwater demand from the shallow aquifer, and it is unlikely that localized drawdown around shallow aquifer pumping wells will extend as far as the San Joaquin River. As such, impacts to GDEs will be less than significant. A groundwater monitoring program will be implemented to assess project drawdown in the shallow and confined aquifer near the Site, and will be used to assess changes to the shallow aquifer well field operation to avoid excessive drawdown in any particular area (see Section 5.6). This program will further reduce the less than significant impacts to GDEs.



## 5.2 Water Quality

**Question IX(a): Would the project violate any water quality standards or waste discharge requirements?**

**Question IX(f): Would the project otherwise substantially degrade water quality?**

The Project includes operation of existing and new groundwater wells in both the shallow and confined aquifers beneath the Site. New wells completed in the confined aquifer will be completed above the base of fresh water and separated from the existing hydrocarbon plume in the shallow aquifer by the Corcoran Clay. Therefore, Project pumping from the confined aquifer will not draw from areas where water is known to have low quality, and will not interfere with shallow aquifer remediation efforts. Pumping from the shallow aquifer to meet non-potable Project water demand will occur outside of the 2,000-foot pumping restriction around the IRP Site 17 contamination plume to avoid capture of contaminated water or interference with remediation efforts. No degradation of irrigation water has been reported over time, which indicates that infiltration of applied groundwater does not substantially degrade groundwater quality, and poor quality water is not being drawn into the area. New wells installed for the Project will not be cross screened across the Corcoran Clay, and so will not create a conduit between zones of varying water quality. The existing cross screened irrigation well will be actively pumped as part of the project, and therefore will not serve as a conduit for water exchange between the shallow and confined aquifers. Based on these considerations, no significant impacts are anticipated.

## 5.3 Subsidence

**Question VI(c): Would the project be located on a geologic unit or soil that is unstable, or that would become unstable as a result of the project, and potentially result in on or off-site landslide, lateral spreading, subsidence, liquefaction, or collapse?**

DWR has designated the entire DMGS as having a high potential for future subsidence, and between 1 and 2.5 inches of subsidence have been reported since 2005 at continuous monitoring station P259 along State Route 33 near the northeast corner of the Site (DWR, 2016b). The DWR and Bureau of Reclamation have undertaken a joint subsidence monitoring program in support of the San Joaquin River Restoration Program that includes a geodetic control network of monitoring stations that spans the Site (USBOR, 2014). Surveying conducted in support of this program indicates that the average subsidence rate near the Site has been in the range of 0 to 0.15 feet per year between December 2011 and December 2015 (USBOR, 2016). Surveys conducted between December 2012 and December 2013 indicate slightly accelerated short term subsidence rates during that time period between 0.15 and 0.3 feet per year (USBOR, 2014).

As discussed in Section 3.5, subsidence in the San Joaquin Valley has occurred mainly when compressible clays are dewatered as a result of drawdown in the confined aquifer system beneath the Corcoran Clay to below historical low levels. Long term hydrographs are not available for any of the

wells at the Site; however, as discussed in Section 3.4.1 and shown on Figure 3.4.1, several wells with long terms hydrograph data are located in the region south of the Site near the City of Newman (DWR, 2016d). Current groundwater levels in the well with the longest period of record (State Well No. 06S08E29J001M) are approximately 40 feet above their historical low level in October 1952. Conversely, groundwater levels in State Well No.'s 07S08D14D001M and 06S08E34M001M are at their historical low levels; however, water level data are not available for these wells prior to October 1958 and March 1959, respectively, so it is not known whether the current low groundwater level elevations at these wells represents the historical low.

Based on the above, it is possible that drawdown induced by the Project near the Delta-Mendota Canal (3 to 13 feet at the end of Phase 3 buildout) could lower groundwater levels to near or below historical low levels. Some subsidence could be induced as a result; however, given the limited amount of drawdown that is predicted and that less than 2 inches of subsidence has been reported near the Site to date, the likelihood of subsidence that substantially interferes with surface land uses and infrastructure is judged to be small. Nevertheless, Mitigation Measure (MM) Water-01 is proposed to monitor for active subsidence and make adjustments to the groundwater extraction program, if needed (see Section 5.6). With implementation of MM Water-01, impacts will be less than significant.

#### **5.4 Chronic Drawdown and Diminution of Supply**

**Question IX(b): Would the project substantially deplete groundwater supplies or interfere substantially with groundwater recharge such that there would be a net deficit in aquifer volume or a lowering of the local groundwater table (e.g., the production rate of pre-existing nearby wells would drop to a level which would not support existing land uses or planned uses for which permits have been granted)?**

Operation of the potable water production wells for the Projects will result in groundwater level drawdown in the confined aquifer in the region around the Site, and will result in interference drawdown to existing supply wells completed in this aquifer. Regional drawdown, if it represents a substantial fraction of the overall available drawdown, or groundwater in storage, in an aquifer system, can result in less water supplies being available for future supply, insufficient availability of groundwater during dry periods, or a general increase in groundwater supply development costs. Interference drawdown is a more localized effect that can decrease well yield and, in extreme cases, cause wells to go dry. The wells potentially most vulnerable to interference drawdown are domestic wells, which are generally shallower than municipal, industrial and irrigation wells that are completed to greater depths and have greater pumping capacities. In the Site vicinity, domestic wells tend to be completed in the shallow aquifer; whereas, higher capacity production wells are completed in either the shallow or the confined aquifer (or both).

The maximum predicted Project-induced drawdown in the confined aquifer is approximately 13 feet. This is less than 10 percent of the available drawdown above the top of the confined aquifer, and is unlikely to result in a significant depletion in regional supplies. For perspective, urban and agricultural groundwater extraction was estimated to be 508,000 AFY for the DMGS (DWR, 2006). An operational yield study by the

City of Patterson estimated that the city could pump up to 12,000 AFY without significantly impacting the use of groundwater resources in the area surrounding Patterson's sphere of influence (RMC, 2016). The City of Newman pumped approximately 4,200 acre-feet of water in 2012 (KDSA, 2013). A drawdown of less than 20 feet would not be expected to result in a significant diminution in the yield in a production well, as it typically represents less than 10 percent of the available drawdown. Drawdown in the shallow aquifer from pumping in the confined aquifer is expected to be negligible. The project will not result in any net increase in groundwater demand from the shallow aquifer; however, if shallow wells located near the Site boundary are pumped excessively, nearby off-site domestic wells could experience drawdown in excess of 5 feet, which could potentially result in a significant diminution in yield in a very shallow well. MM Water-02 is proposed to place new shallow wells at least 250 feet from the nearest Site boundary. In addition, MM Water-03 is proposed to implement a groundwater level monitoring program, and adjust well field operation if drawdown in excess of 5 feet is observed near an existing domestic well. (See Section 5.6 for a description of these mitigation measures.)

Development of the Project will include retention of stormwater such that off Site stormwater flows do not increase above pre-development flows. The majority of this retention will occur as a result of water infiltration in the retention basins to be constructed on the northeast side of the CLIBP. In addition, the Project will require implementation of LID performance standards for stormwater capture and recharge at each developed parcel in order to maintain the existing groundwater balance in the shallow aquifer.

Based on the above information, with implementation of MM Water-02 and MM Water-03, Project impacts to groundwater supplies, aquifer volume, and lowering of the groundwater table will be less than significant.

**Question XVIII(b): Does the project have impacts that are individually limited, but cumulatively considerable? ("Cumulatively considerable" means that the incremental effects of a project are considerable when viewed in connection with the effects of past projects, the effects of other current projects, and the effects of probable future projects.)**

Predictive modeling indicates that drawdown associated with Project pumping from the confined aquifer will contribute incrementally to the cones of depression observed to the northwest and south of the Site. The Project-related drawdown at the off-Site cones of depression is predicted to range from approximately 1 to 6 feet at completion of Phase 3 buildout. This represents only about 1 to 10 percent of drawdown in the off Site cones of depression, which was on the order of 50 to 100 feet in fall 2015, and appears to be associated with increased extraction during recent drought conditions and curtailment of surface water deliveries. Long-term well hydrographs indicate that water levels have historically rebounded relatively quickly when stresses are relieved (i.e., when drought conditions end or demand is met by surface water deliveries). Subsidence and other undesirable results have not been reported in the vicinity of these cones of depression.

Municipal groundwater demand by the City of Patterson is projected to increase from 6,376 AFY in 2020 to 11,801 AFY in 2040 (RMC, 2016). Proportionally similar increases in urban demand may be expected by the City of Newman and the community of Crows Landing, assuming they experience similar urban growth.

These increases in urban demand will be offset by decreased agricultural demand as land use is changed from agricultural to urban to accommodate the population growth on which the water demand forecasts are built. In addition, these communities will be required to comply with a GSP adopted under SGMA to assure the sustainable management of local groundwater supplies by 2040. The communities of Patterson and Newman are currently considering becoming Groundwater Sustainability Agencies that will implement and enforce the GSP within their jurisdiction.

Based on these considerations, the groundwater resources impacts associated with the Project will be less than cumulatively considerable.

## 5.5 Water Supply and Entitlements

**Question XVII(d): Would the project have sufficient water supplies available to serve the project from existing entitlements and resources, or are new or expanded entitlements needed?**

Based on the above analyses, adequate groundwater supplies are available for Project use in the shallow and confined aquifers beneath the Site without causing or contributing to undesirable results as defined in the County Groundwater Ordinance, SGMA, and the California Water Code. As such, the proposed groundwater extraction would comply with these regulations. In addition, the Site is not located in an adjudicated basin, or in a special act district that regulates the extraction of groundwater. The Project would be able to supply groundwater for beneficial use on the properties to be developed in the business park under an appropriate groundwater right. No new entitlements would be required, and the Project would therefore have no impact.

## 5.6 Proposed Mitigation Measures

This section identifies mitigation measures to reduce potentially significant impacts associated with the Project to less than significant levels.

### 5.6.1 MM Water-01 – Subsidence Monitoring

The objective of MM Water-01 is to prevent subsidence associated with the Project. The Project shall include installation and semi-annual monitoring of three subsidence monuments at the Site. The exact construction, placement, and monitoring methodology shall be defined in a subsidence monitoring plan to be prepared for County approval before Project implementation. It is advised that one monument be placed near the Delta-Mendota Canal and/or the California Aqueduct, for which subsidence may be of particular concern. The monitoring entity shall report the subsidence monitoring activities and findings semi-annually to Stanislaus County for each year in July and January. If subsidence in excess of 2 inches is measured at a monument, an investigation shall be undertaken to determine the source of the subsidence and whether changes need to be made to the water supply pumping program to arrest further subsidence that could be damaging to infrastructure.

### **5.6.2 MM Water-02 – Well Setbacks**

The objective of MM Water-02 is to prevent interference drawdown to off-Site wells. Any new shallow groundwater extraction well shall be placed at least 250 feet inside of the nearest Site boundary to minimize potential drawdown effects on shallow aquifer wells located on nearby properties. A well permit application shall be prepared by the applicant for County approval to identify the new well(s) purpose, location(s), and construction details before the wells are constructed.

### **5.6.3 MM Water-03 – Groundwater Level Monitoring**

The objective of MM Water-03 is to assess and verify the amount of drawdown induced by Project pumping, and to prevent potential interference drawdown to shallow off-Site wells. A groundwater monitoring plan that outlines the monitoring wells network and procedures for the groundwater level monitoring program shall be prepared by the applicant for County approval before Project implementation. Groundwater levels shall be measured monthly to the nearest 0.1 foot bgs in the shallow and confined aquifers at the locations identified in the groundwater monitoring plan, and the length of time in days since the well was last operated shall also be noted. Groundwater level monitoring shall commence prior to Project implementation to establish Site baseline conditions. The extent and frequency of the monitoring program shall be evaluated every five years. The groundwater monitoring plan shall identify adjustments to be made to well field operation if Project-induced drawdown in excess of 5 feet is observed in the shallow aquifer near an existing domestic well, or if drawdown in the confined aquifer exceeds predicted levels. The monitoring entity shall report the groundwater monitoring activities and findings to Stanislaus County for each year by January 31 of the following year.

### **5.6.4 MM Water-04 – Recharge Enhancement Plan**

The objective of MM Water-04 is to prepare a plan that describes how the Project will enhance groundwater recharge, such that any increase in Project groundwater demand on the shallow aquifer will be fully offset. The plan shall be prepared by the applicant for County approval before Project implementation. After County approval, the plan shall be implemented, including submittal of annual reports to the County by January 31 of the following year that document the amount of groundwater extracted from the shallow aquifer and the amount of recharge achieved. The plan must account for and offset any increase in the net groundwater demand, including increases resulting from development of the Project non-potable water supply and cessation of agricultural pumping and irrigation. The enhanced recharge is expected to be derived from recharge of water in the Project stormwater retention/detention basin, implementation of LID design standards for developed parcels in the CLIBP that increase stormwater retention and recharge, and decreased non-potable water demand through the use of xeriscape landscape designs. The plan shall include design details and describe maintenance activities, and shall include supporting calculations or modeling to demonstrate that its implementation will result in sufficient recharge.

## 6.0 REFERENCES

- AECOM, 2011. *Groundwater Management Plan for the Northern Agencies in the Delta-Mendota Canal Service Area, Groundwater Management Plan Update*. Revised November 7.
- AECOM, 2016a. *Draft County of Stanislaus, Crows Landing Industrial Business Park, SB 610 Water Supply Assessment*. February.
- AECOM, 2016b. *Drainage Study for Crows Landing Industrial Business Park, Stanislaus County*. October.
- AECOM, 2016c. *Draft Specific Plan for Crows Landing Industrial Business Park, Stanislaus County*. October.
- AECOM and VVH Consulting Engineers, 2016. *Crows Landing Industrial Business Park, Water Supply (Potable and Non-Potable) Infrastructure and Facilities Study*. September 27.
- California Department of Water Resources (DWR), 2003. *California's Groundwater, Bulletin 118 – Update 2003*. October.
- DWR, 2006. *California's Groundwater Bulletin 118, San Joaquin River Hydrologic Region, San Joaquin Valley Groundwater Basin, Delta-Mendota Subbasin*. Updated January 20.
- DWR, 2013. *California's Groundwater Update 2013, A Compilation of Enhanced Content for California Water Plan Update 2013, Chapter 8 – San Joaquin River Hydrologic Region*.
- DWR, 2016a. SGM Sustainable Groundwater Management, Critically Overdrafted Basins. <http://www.water.ca.gov/groundwater/sgm/cod.cfm>. Accessed May 20.
- DWR, 2016b. Groundwater Information Center Interactive Map Application. <https://gis.water.ca.gov/app/gicima/>. Accessed May 20.
- DWR, 2016c. California Data Exchange Center Data for San Joaquin River Gaging Stations. <http://cdec.water.ca.gov/cdecstation/?sta=SMN>, <http://cdec.water.ca.gov/cdecstation/?sta=SCL>. Accessed July 11.
- DWR, 2016d. California Statewide Groundwater Elevation Monitoring (CASGEM) website. <http://www.water.ca.gov/groundwater/casgem/>. Accessed July.
- DWR and Bureau of Reclamation, 2014. Technical Memorandum, Subsidence Monitoring 2011 – 2013, San Joaquin River Restoration Program. September.
- Fetter, C.W., 1994. *Applied Hydrogeology*. Third Edition. 691 p.
- Fitts Geosolutions, 2016. AnAqSim Release 2016-2. July 8.
- Google Earth, 2016. Historical Imagery from Multiple Data Providers, 2006 to 2015. Accessed July 28.
- Kenneth D. Schmidt and Associates (KDSA), 2010. *Existing Groundwater Conditions in the Vicinity of the Proposed Riddle Surface Mine, Stanislaus County, California*. September.

- KDSA, 2013. *Supplement to Water Supply Assessment for Arambel Business Park/KDN Retail Center*. August.
- Kleinfelder, 2016. *Permit No.15-293, Supplemental Request: Well-1 Aquifer Pumping Test and Drawdown Evaluation, Joe's Travel Plaza, Westley, CA*. March 15.
- Page, R.W., 1973. *Base of Fresh Ground Water (Approximately 3,000 Micromhos) in the San Joaquin Valley, California*. U.S. Geological Survey Open File Report.
- Reilly, Thomas E., Franke, O. Lehn, and Bennett, Gordon D., 1987. *The Principle of Superposition and its Application in Ground-Water Hydraulics*. U.S. Geological Survey Techniques of Water-Resources Investigations 03-B6.
- RMC, 2016. *City of Patterson 2015 Urban Water Management Plan, Final*. June.
- Sperling's Best Places, 2016. <http://www.bestplaces.net/climate/county/california/stanislaus>. Accessed April 25.
- Summers Engineering, 2013. *WaterSMART: Water and Energy Efficiency Grant for FY 2013, Patterson Irrigation District, Marshall Road and Spanish Drain Return System*.
- Turlock Irrigation District, 2012. *2012 Agricultural Water Management Plan*.
- U.S. Bureau of Reclamation (USBOR), 2014. *Technical Memorandum, Subsidence Monitoring San Joaquin River Restoration Program 2011 – 2013*.
- USBOR, 2016. *Central Valley Subsidence, Annual Rates December 2011 – December 2015*.
- U.S. Geological Survey (USGS), 2004. *Hydrogeologic Characterization of the Modesto Area, San Joaquin Valley, California*: U.S. Geological Survey Scientific Investigations Report 2004-5232, 54 p.
- USGS, 2009. *Groundwater Availability of the Central Valley Aquifer, California*: U.S. Geological Survey Professional Paper 1766, 225 p.
- USGS, 2016. *Delta-Mendota Canal: Evaluation of Groundwater Conditions and Land Subsidence*. <http://ca.water.usgs.gov/projects/central-valley/delta-mendota-canal-subsidence.html>. Accessed July 28, 2016.
- Ward, W., 2016. Personal communication regarding analysis of specific capacity test data for two wells near the proposed Crows Landing Industrial Business Park. To M. Tietze, JJ&A. July 14.
- Wheeler, D., 2016. Personal communication regarding groundwater extraction and use at the proposed Crows Landing Industrial Business Park. To M. Tietze, JJ&A. June 13.

**APPENDIX A**

**EVALUATION OF POTENTIAL STORMWATER CAPTURE EFFICIENCY FROM LOW IMPACT  
DEVELOPMENT STANDARDS**



## Appendix A: Evaluation of Potential Stormwater Capture Efficiency from Low Impact Development Standards

A screening level desktop study was performed to evaluate potential stormwater capture efficiency from Low Impact Development (LID) standards using the U.S. Environmental Protection Agency's (EPA) National Stormwater Calculator (SWC) software<sup>1</sup>. The study was performed as a superposition model to evaluate potential increases in capture and infiltration of surface runoff with LID elements compared with a baseline condition (buildout of the Project with no LID elements, but with required stormwater retention using a retention pond in the northeast portion of the Site). Attachment A-1 shows the SWC summary reports for both the baseline and LID implementation conditions. The basis for key assumptions and inputs are summarized below:

- The calculated storm water capture applies to additional capture that may be achieved at individual development sites through the implementation of LID elements, such as retention ponds, permeable pavements, street planters, vegetated swales, and disconnection. It is assumed that the stormwater retention basin to be constructed in the northeast portion of the Site will have sufficient infiltration capacity to maintain pre-development recharge rates.
- The site area was defined as 1 acre so that runoff calculations could be scaled appropriately based on the size of development by Project phase.
- The soil was assigned "moderately high" runoff potential (clay loam type) based on soil survey data accessed by the SWC.
- The soil was assigned a drainage rate of 0.6 feet per day based on the mean saturated hydraulic conductivity at the Site<sup>2</sup>.
- The topography was assigned a flat (2%) slope.
- Precipitation was assigned as 11.53 inches per year based on average rainfall data at Newman from 1970 to 2006 (as accessed by the SWC).
- Evaporation was assigned as 0.22 inches per day based on data at Newman from 1970 to 2006 (as accessed by the SWC).
- The SWC default climate change scenario was applied for the near term scenario (2020 through 2049).
- Land cover (at buildout) was estimated to be 75% impervious surface based on visual review of typical recent commercial projects in the County, with the remaining 25% assigned as "lawn" to simulate landscaping
- Conceptual LID elements<sup>3</sup> were assigned as follows:

---

<sup>1</sup> EPA, 2016. National Stormwater Calculator Desktop Application. Version 1.1.0.2.

<sup>2</sup> University of California Davis and U.S. Department of Agriculture Natural Resources Conservation Service, 2016. California Soil Properties Soil Properties App. <http://casoilresource.lawr.ucdavis.edu/ca-soil-properties/>. Accessed July 31.

- The baseline condition did not include any LID elements.
- The LID implementation condition assumed the Project impervious surfaces consisted of: 20% permeable pavement; 10% infiltration basins; 10% disconnection (directing runoff from impervious areas such as roofs or parking lots onto pervious surfaces rather than into storm drains); and 2% street planters.

Based on the inputs described above, the SWC estimated that 2.89 inches (0.24 foot) per year of runoff per acre would be captured for local infiltration with LID implementation compared with the baseline condition with no local LID elements (Project detention basin only). The volume of additional runoff that could be captured with LID implementation at buildout of Phases 1, 2, and 3 is estimated to be 146, 178, and 228 AFY, respectively, as summarized in the table below.

**Estimated Additional Annual Surface Runoff Capture Compared with the Baseline (No LID) Condition**

<b>Timeframe</b>	<b>Additional Surface Runoff Capture (AFY)</b>
<i>Additional Capture by Buildout Phase</i>	
Phase 1 (810 acres developed)	146
Phase 2 (177 acres developed)	32
Phase 3 (274 acres developed)	49
<i>Cumulative Additional Capture at Phased Buildout</i>	
Phase 1 (810 acres developed)	146
Phase 2 (987 acres developed)	178
Phase 3 (1,261 acres developed)	228

---

<sup>3</sup> Specific LID elements would be determined during Project design.

# National Stormwater Calculator Report

## Site Description

Crows Landing Industrial Business Park

Parameter	Current Scenario	Baseline Scenario
Site Area (acres)	1	1
Hydrologic Soil Group	C	C
Hydraulic Conductivity (in/hr)	0.6	0.6
Surface Slope (%)	2	2
Precip. Data Source	NEWMAN	NEWMAN
Evap. Data Source	NEWMAN	NEWMAN
Climate Change Scenario	None	None
% Forest	0	0
% Meadow	0	0
% Lawn	25	25
% Desert	0	0
% Impervious	75	75
Years Analyzed	20	20
Ignore Consecutive Wet Days	False	False
Wet Day Threshold (inches)	0.10	0.10

LID Control	Current Scenario	Baseline Scenario
Disconnection	10 / 100	0
Rain Harvesting	0	0
Rain Gardens	0	0
Green Roofs	0	0
Street Planters	2 / 6	0
Infiltration Basins	10 / 5	0
Porous Pavement	20 / 100	0

% of impervious area treated / % of treated area used for LID

# National Stormwater Calculator Report

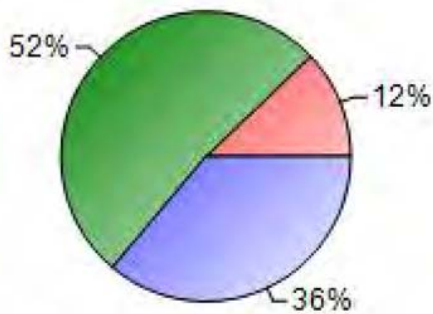
## Summary Results

Crows Landing Industrial Business Park

Statistic	Current Scenario	Baseline Scenario
Average Annual Rainfall (inches)	12.01	12.01
Average Annual Runoff (inches)	4.35	7.24
Days per Year With Rainfall	29.68	29.63
Days per Year with Runoff	13.79	19.64
Percent of Wet Days Retained	53.54	33.73
Smallest Rainfall w/ Runoff (inches)	0.22	0.10
Largest Rainfall w/o Runoff (inches)	0.33	0.23
Max. Rainfall Retained (inches)	1.96	1.02

**Current Scenario**

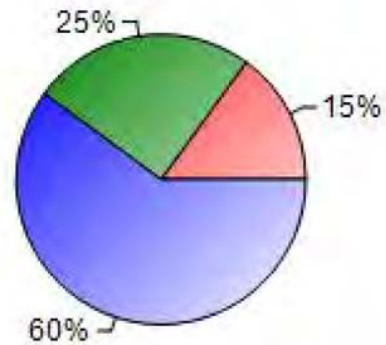
Annual Rainfall = 12.01 inches



Runoff Infil. Evap.

**Baseline Scenario**

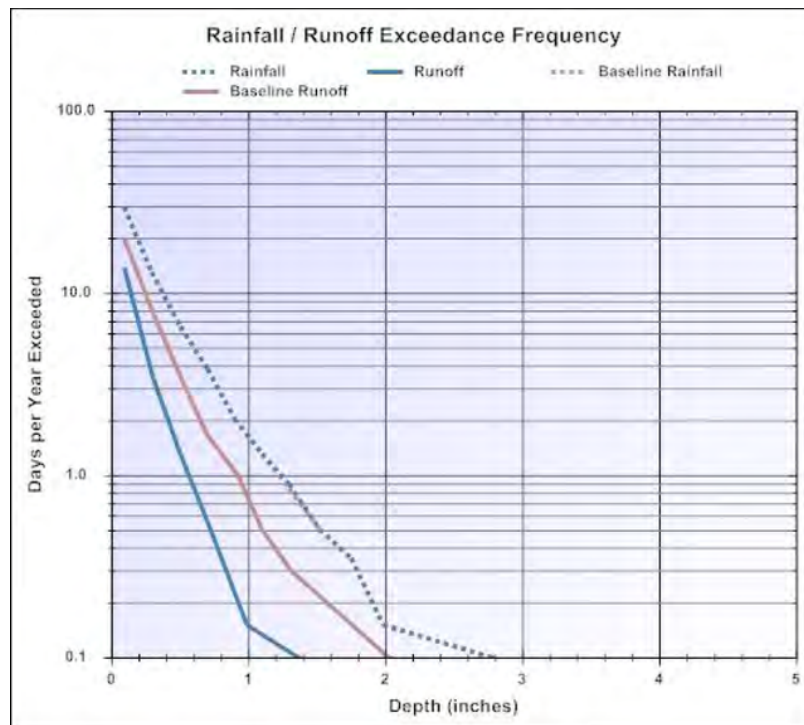
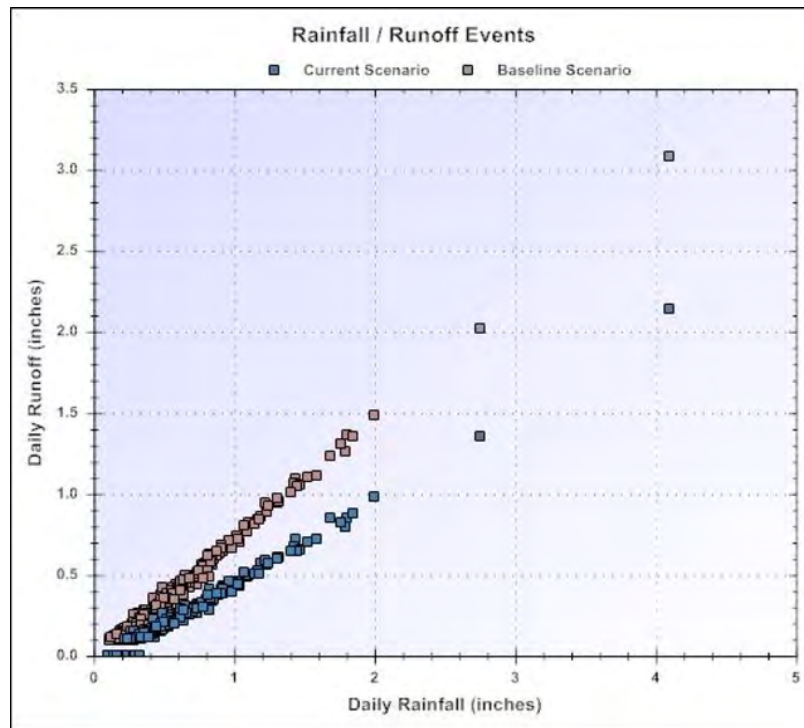
Annual Rainfall = 12.01 inches



Runoff Infil. Evap.

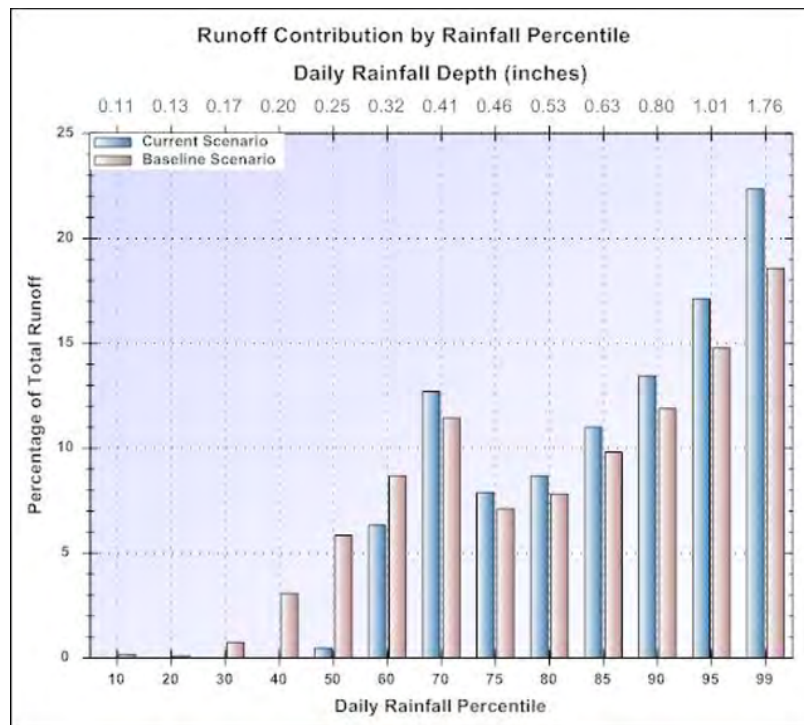
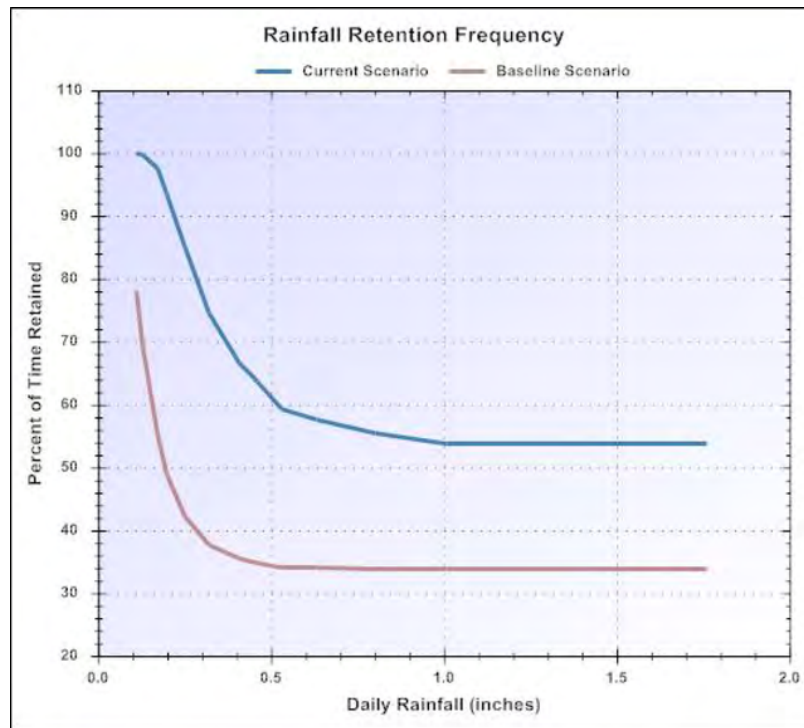
# National Stormwater Calculator Report

## Crows Landing Industrial Business Park



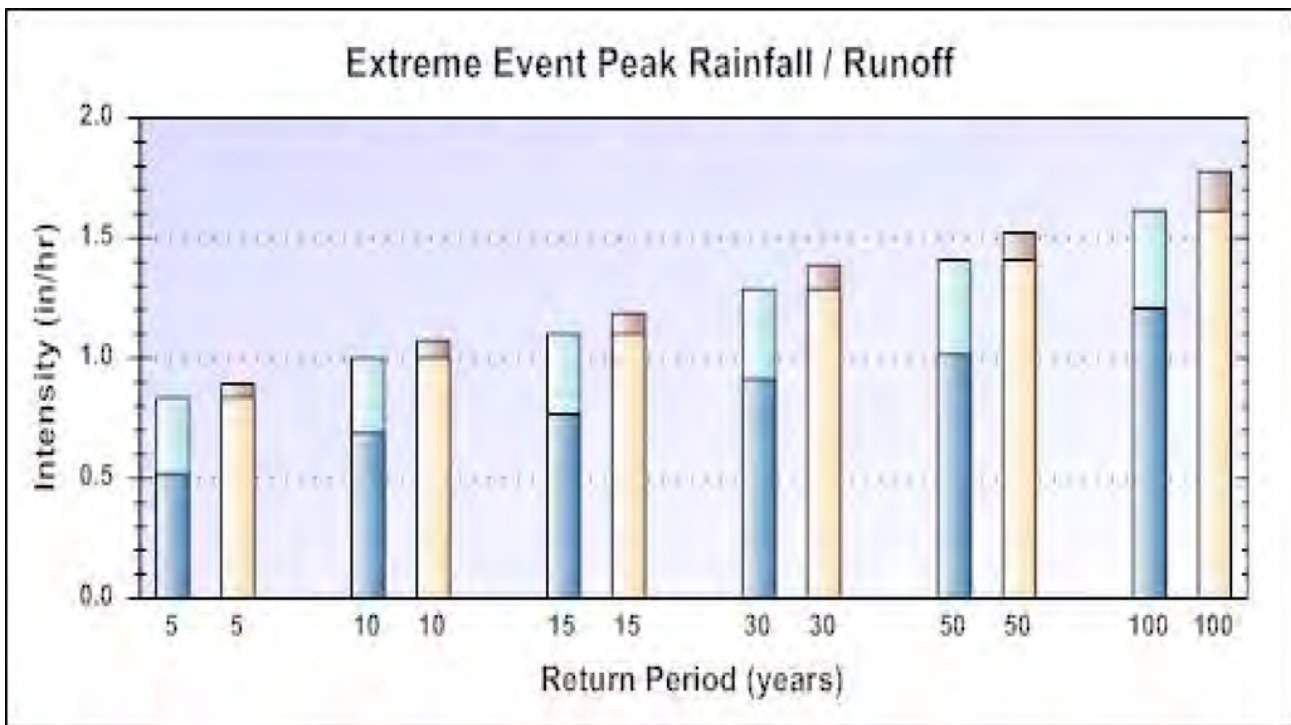
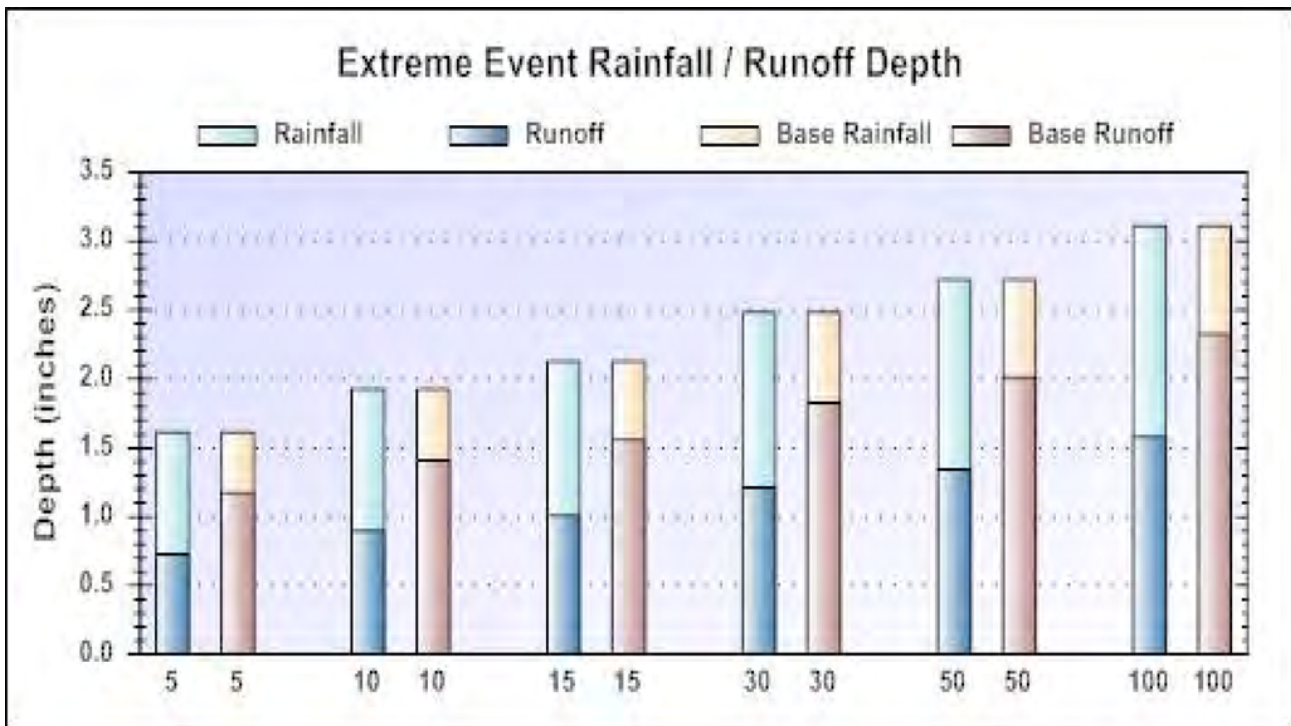
# National Stormwater Calculator Report

## Crows Landing Industrial Business Park



# National Stormwater Calculator Report

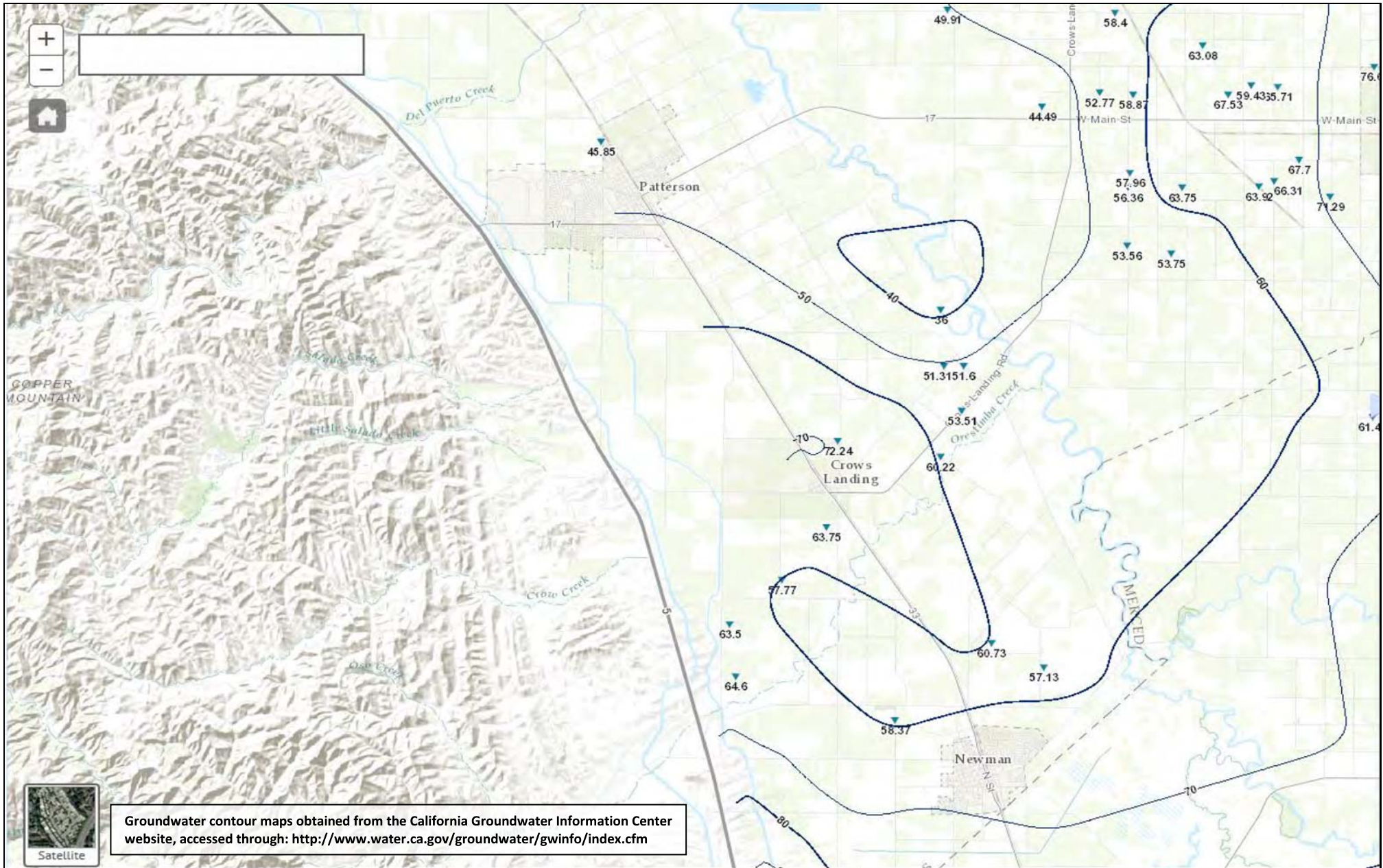
Crows Landing Industrial Business Park



**APPENDIX B**

**GROUNDWATER ELEVATION CONTOUR MAPS FROM THE DWR GROUNDWATER INFORMATION  
CENTER INTERACTIVE MAPPING APPLICATION**





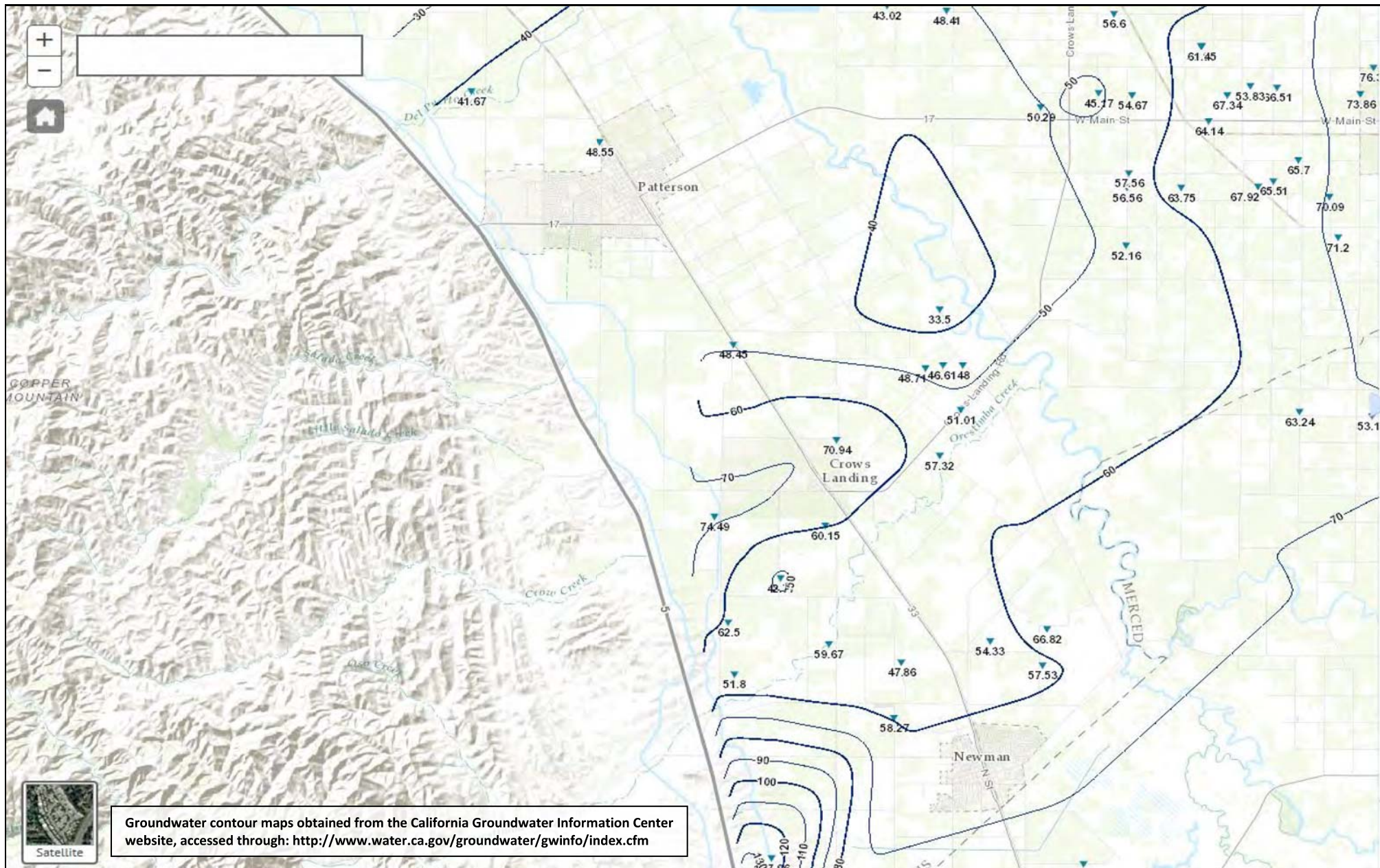
**JACOBSON | JAMES**  
 & associates, inc

Crows Landing Industrial Business Park  
 Stanislaus County, California

FIGURE B-1

**Groundwater Elevation Map for the Confined  
 Aquifer, Spring 2011**

PROJECT NO.	DATE	DRAWN BY	APPR. BY
STANCO.001	7/28/16	TC	JB



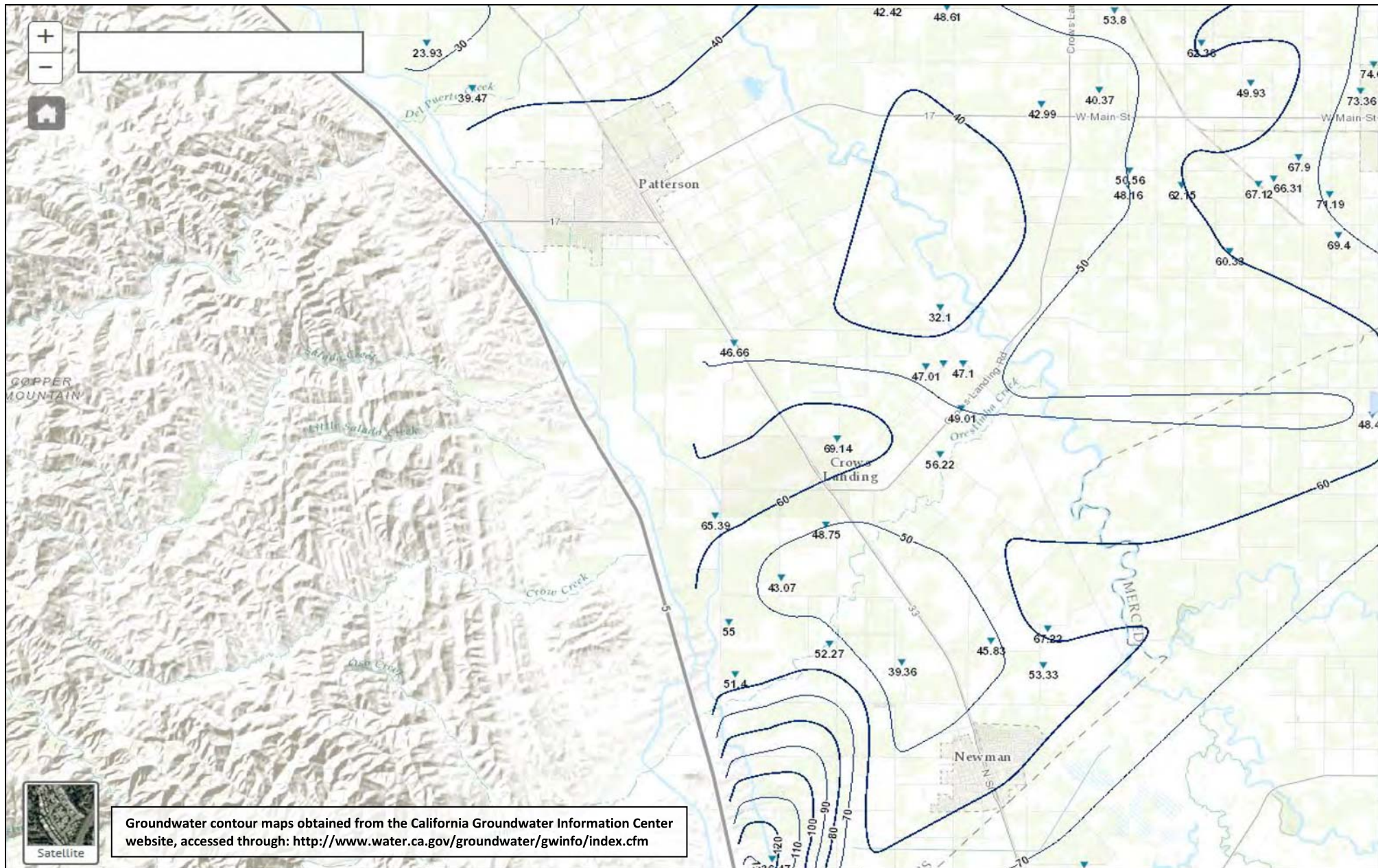
**JACOBSON | JAMES**  
 & associates, inc

Crows Landing Industrial Business Park  
 Stanislaus County, California

FIGURE B-2

**Groundwater Elevation Map for the Confined  
 Aquifer, Spring 2012**

PROJECT NO.	DATE	DRAWN BY	APPR. BY
STANCO.001	7/28/16	TC	JB



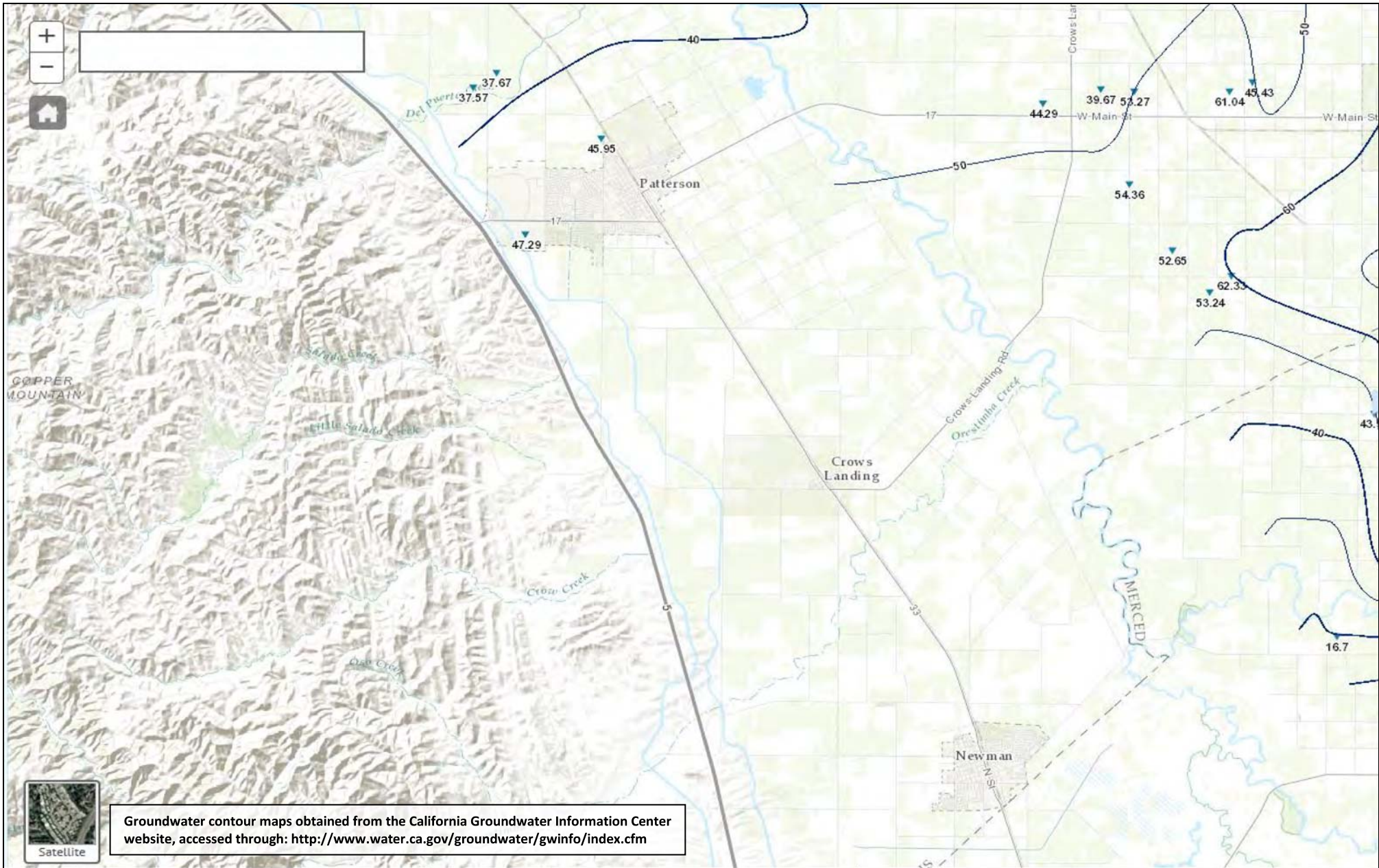
**JACOBSON | JAMES**  
 & associates, inc

Crows Landing Industrial Business Park  
 Stanislaus County, California

FIGURE B-3

**Groundwater Elevation Map for the Confined  
 Aquifer, Spring 2013**

PROJECT NO.	DATE	DRAWN BY	APPR. BY
STANCO.001	7/28/16	TC	JB



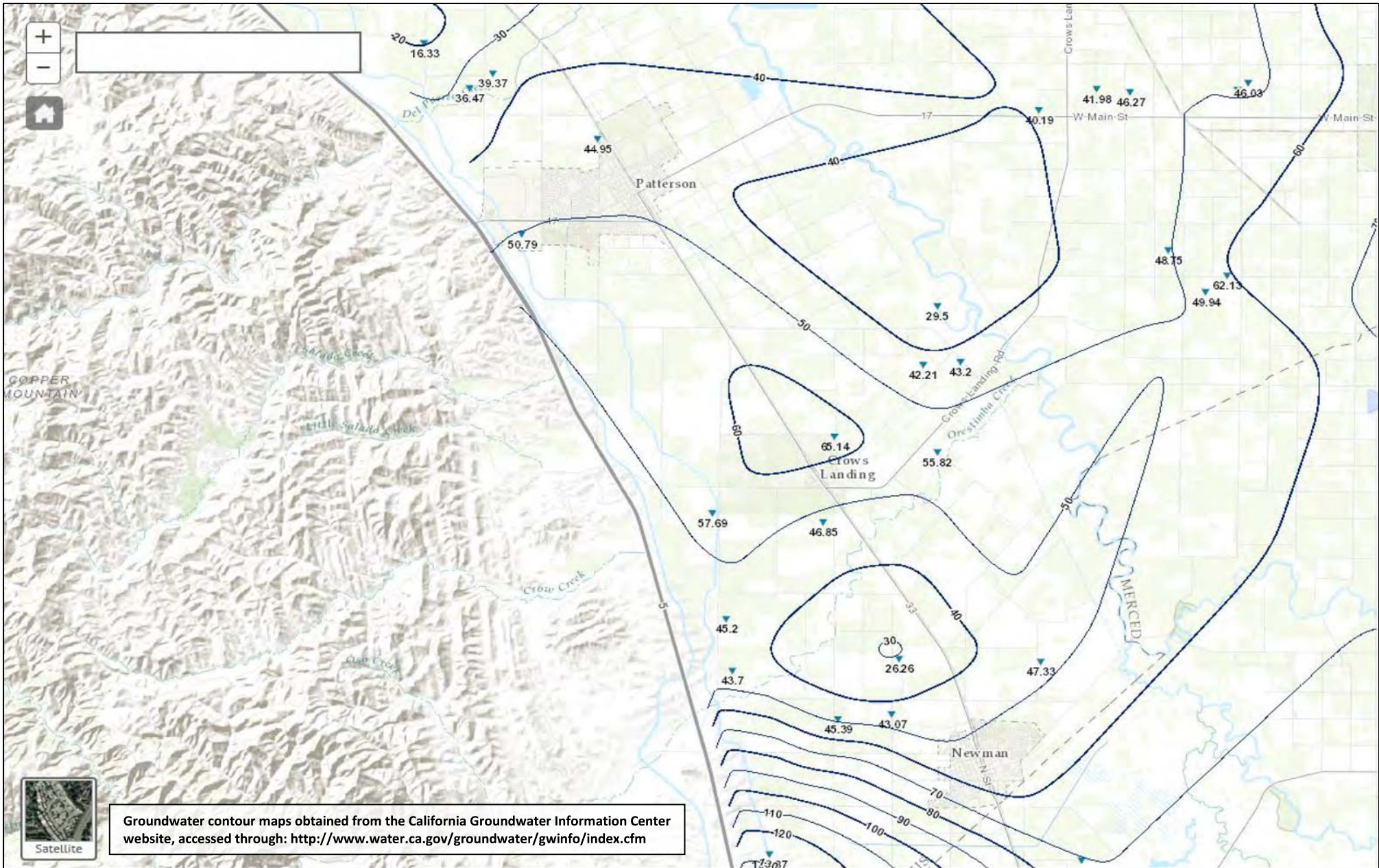
**JACOBSON | JAMES**  
 & associates, inc

Crows Landing Industrial Business Park  
 Stanislaus County, California

FIGURE B-4

**Groundwater Elevation Map for the Confined  
 Aquifer, Fall 2013**

PROJECT NO.	DATE	DRAWN BY	APPR. BY
STANCO.001	7/28/16	TC	JB



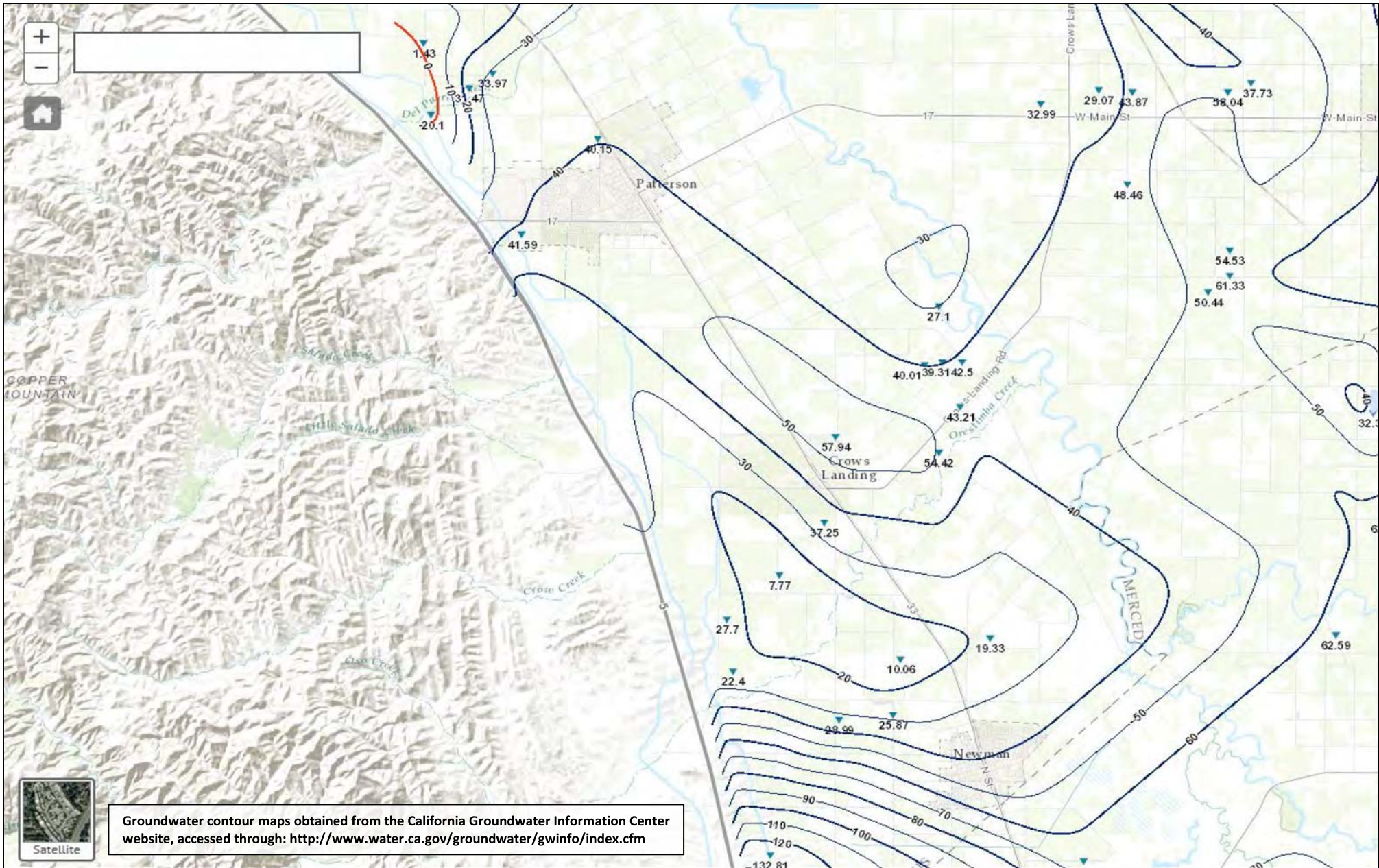
**JACOBSON | JAMES**  
 & associates, inc

Crows Landing Industrial Business Park  
 Stanislaus County, California

FIGURE B-5

**Groundwater Elevation Map for the Confined  
 Aquifer, Spring 2014**

PROJECT NO.	DATE	DRAWN BY	APPR. BY
STANCO.001	7/28/16	TC	JB



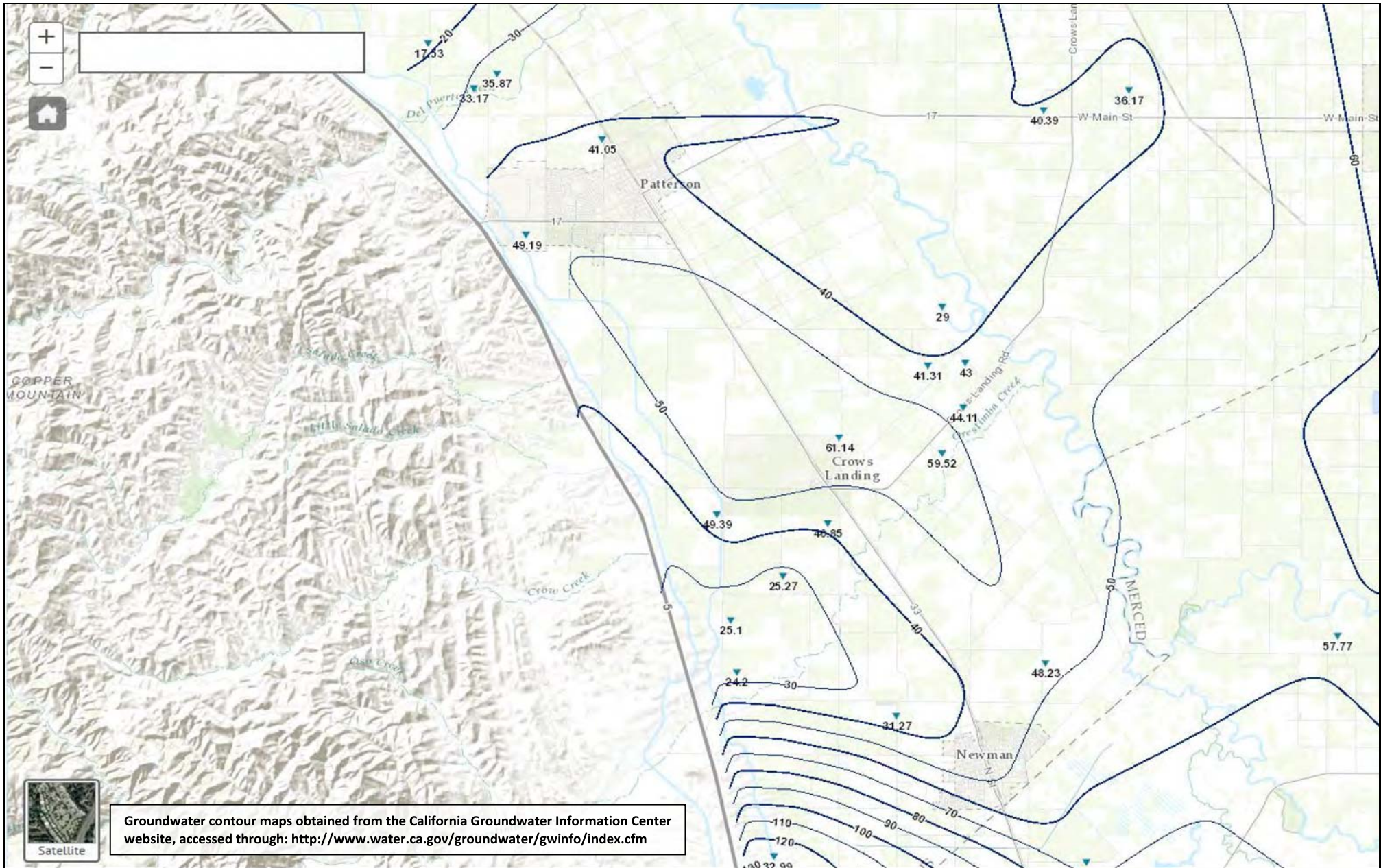
**JACOBSON | JAMES**  
 & associates, inc

Crows Landing Industrial Business Park  
 Stanislaus County, California

FIGURE B-6

**Groundwater Elevation Map for the Confined  
 Aquifer, Fall 2014**

PROJECT NO.	DATE	DRAWN BY	APPR. BY
STANCO.001	7/28/16	TC	JB



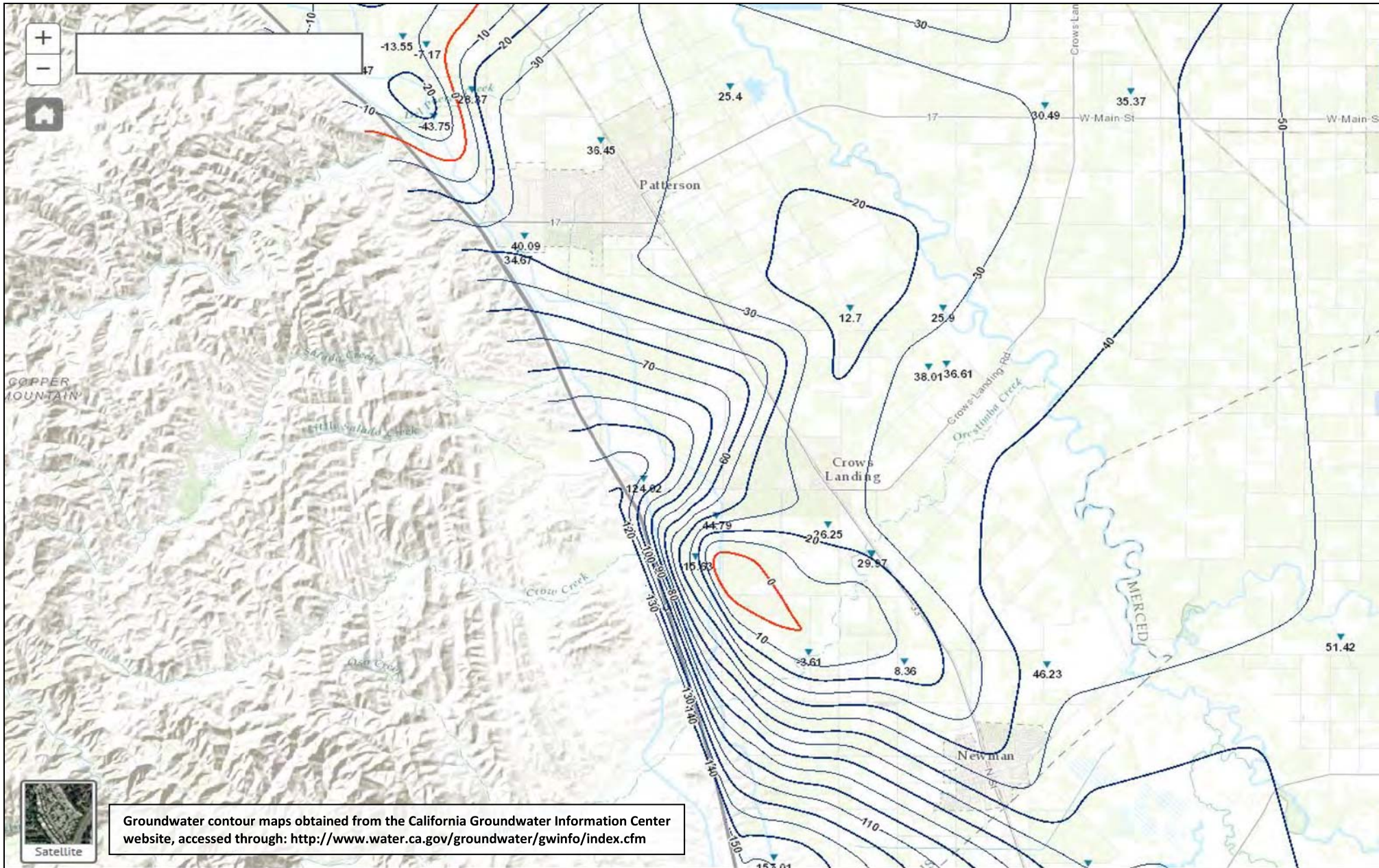
**JACOBSON | JAMES**  
 & associates, inc

Crows Landing Industrial Business Park  
 Stanislaus County, California

FIGURE B-7

**Groundwater Elevation Map for the Confined  
 Aquifer, Spring 2015**

PROJECT NO.	DATE	DRAWN BY	APPR. BY
STANCO.001	7/28/16	TC	JB



**JACOBSON | JAMES**  
 & associates, inc

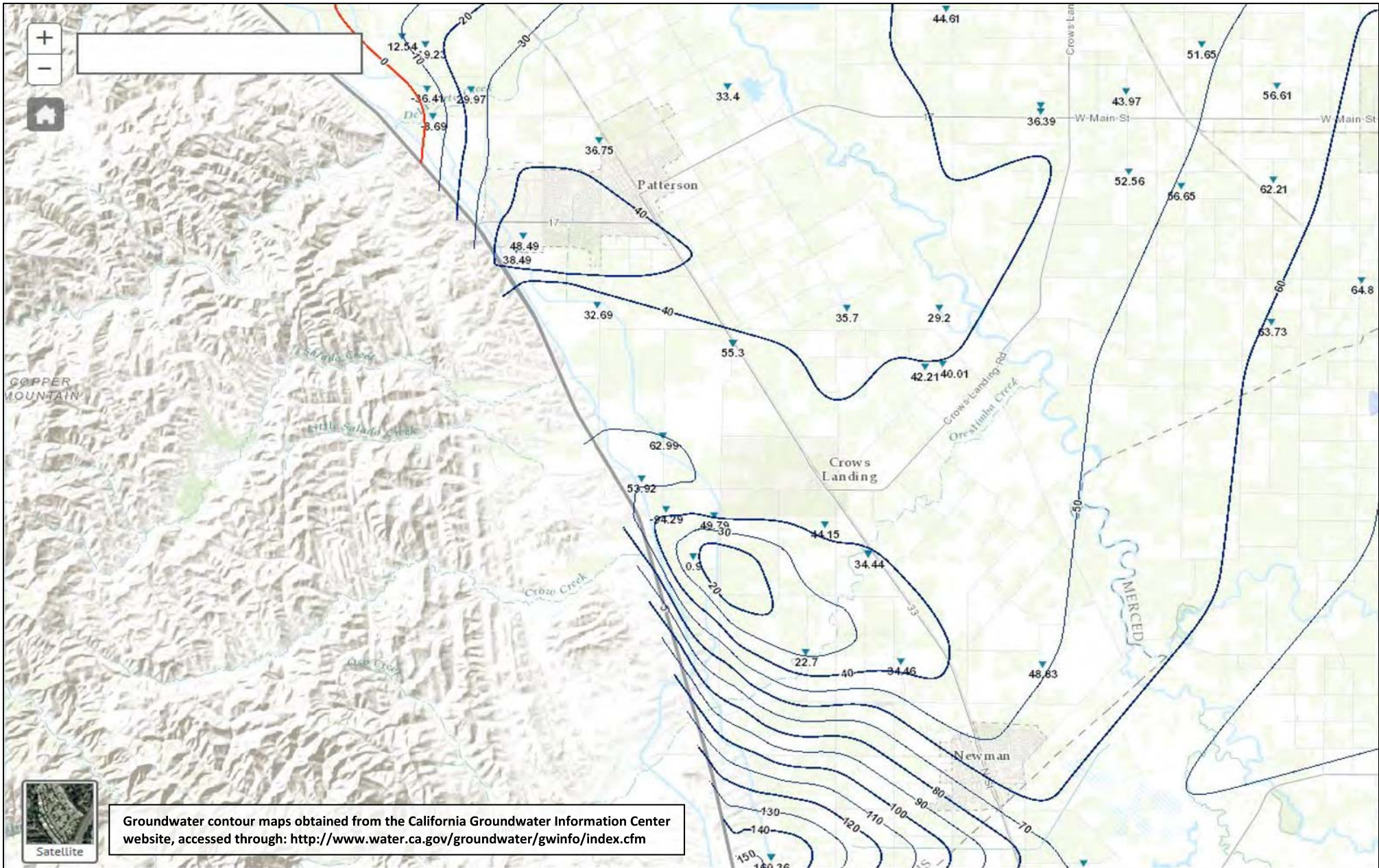
Crows Landing Industrial Business Park  
 Stanislaus County, California

FIGURE B-8

**Groundwater Elevation Map for the Confined  
 Aquifer, Fall 2015**

PROJECT NO.	DATE	DRAWN BY	APPR. BY
STANCO.001	7/28/16	TC	JB





**JACOBSON | JAMES**  
 & associates, inc

Crows Landing Industrial Business Park  
 Stanislaus County, California

FIGURE B-9

**Groundwater Elevation Map for the Confined  
 Aquifer, Spring 2016**

PROJECT NO.	DATE	DRAWN BY	APPR. BY
STANCO.001	7/28/16	TC	JB

## **APPENDIX B**

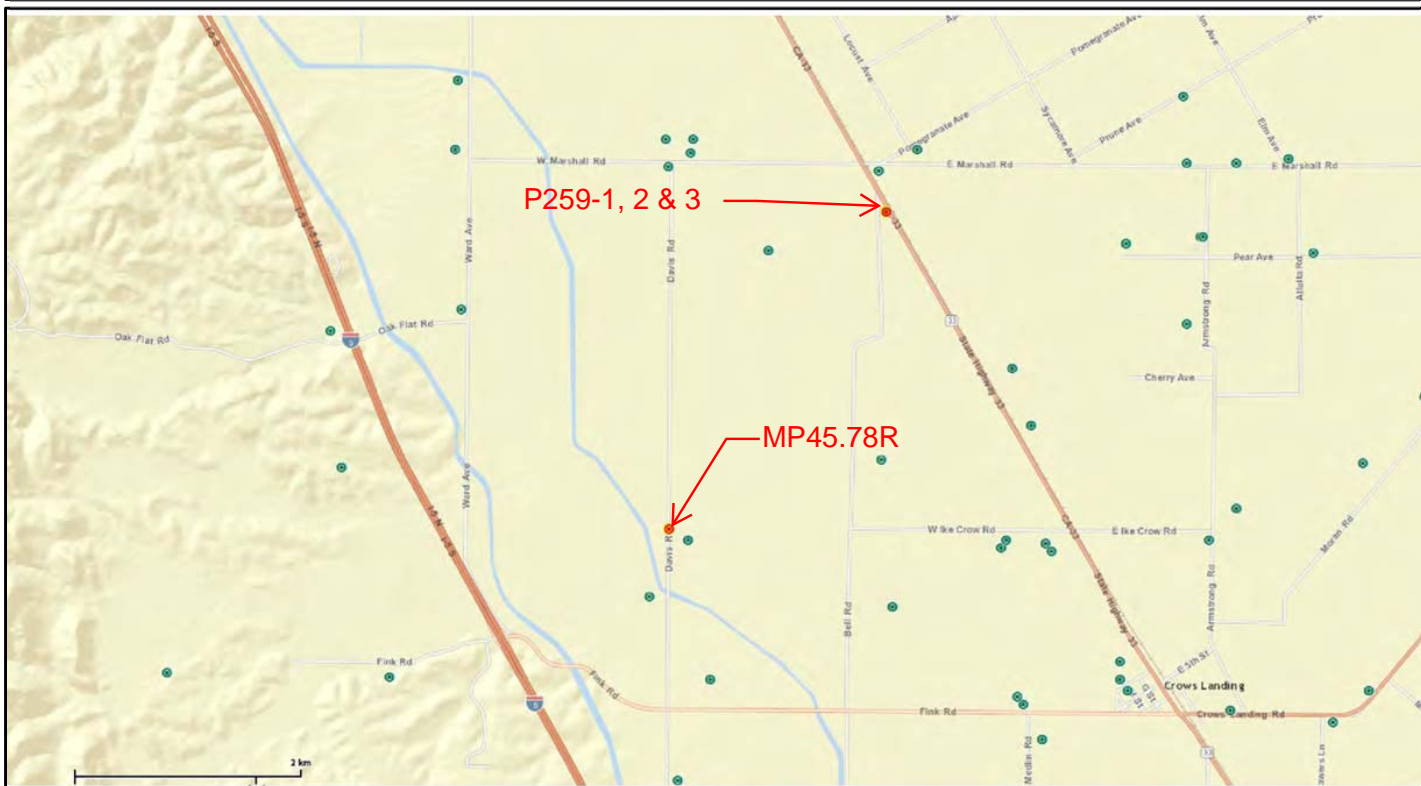
# **CASGEM Well Data and Model Export Data**

CASGEM WELL DATA



# CASGEM Wells

## Crows Landing Industrial Business Park



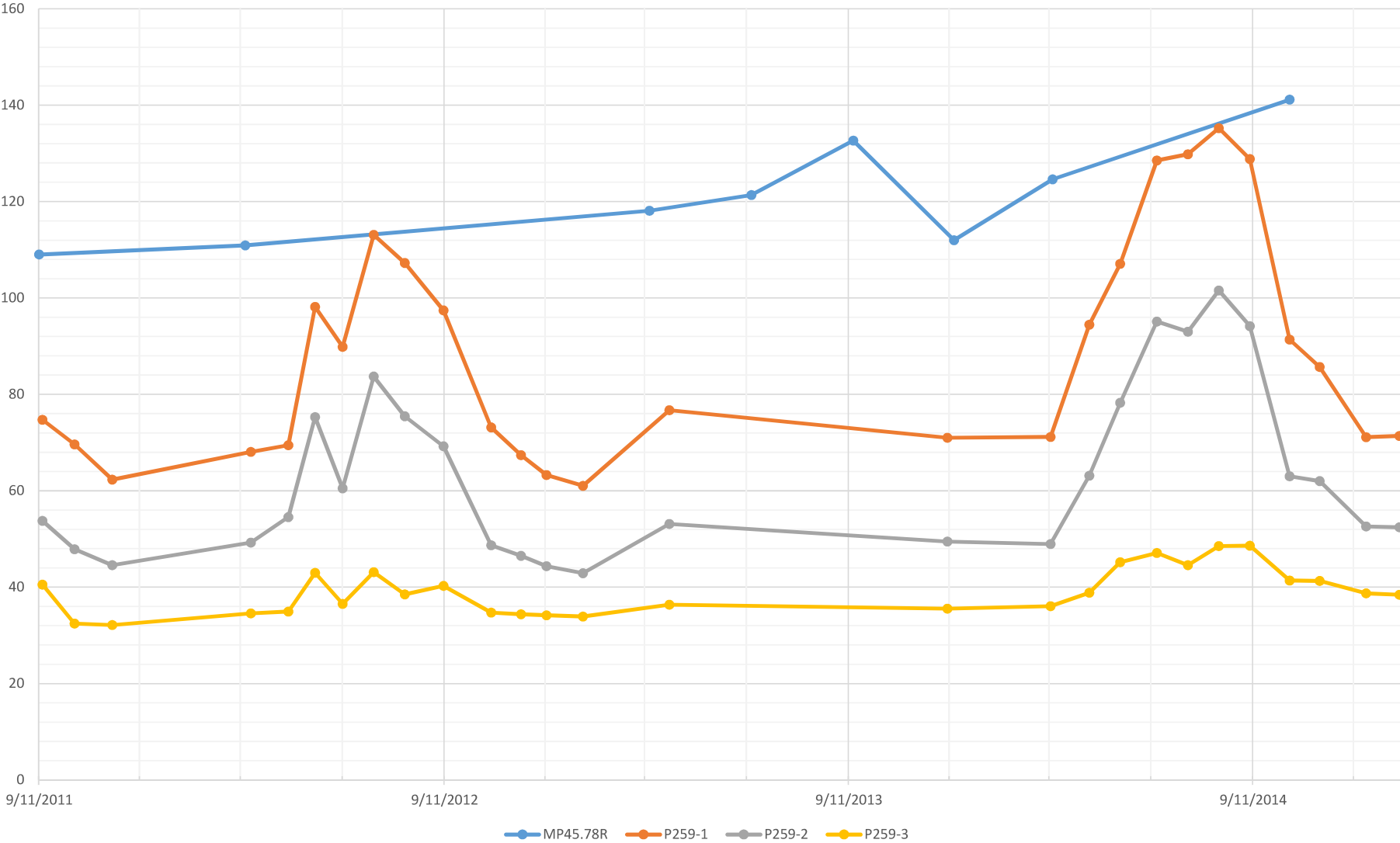
Well
 County
 Township
 DWR Region Office
 Basin Unmonitored

Groundwater Basin
 Section
 Hydrologic Region
 Designated

Disclaimer: The Department of Water Resources does not guarantee the accuracy, completeness, timeliness, or correct sequencing of this information. Neither DWR nor any of the sources of the information shall be responsible for any errors or omissions, or for the use or results obtained from the use of this information.

Print Date: Wed Feb 11 2015 11:13:51 AM

CASGEM WELLS MP45.78R, P259-1, 2 & 3  
GROUNDWATER ELEVATIONS



CASGEM ID	Local Well Number	Date	Military Time (PST)	Reading @RP	Reading @WS	RP to WS	RP Elevation	GS Elevation	WSE	GS to WS	Measurement Method	Measurement Accuracy	Collecting/ Co-op Agency	Voluntary or CASGEM Measurement
374061N1211212W001	MP45.78R	9/11/2011	00:00	109.500	0.000	109.500	153.500	153.000	44.000	109.000	ST - Steel tape measurement	0.1 Ft	San Luis & Delta-Mendota Water Authority	CASGEM
374061N1211212W001	MP45.78R	9/11/2011	00:00	109.500	0.000	109.500	153.500	153.000	44.000	109.000	ST - Steel tape measurement	0.1 Ft	San Luis & Delta-Mendota Water Authority	CASGEM
374061N1211212W001	MP45.78R	9/11/2011	00:00	109.500	0.000	109.500	153.500	153.000	44.000	109.000	ST - Steel tape measurement	0.1 Ft	San Luis & Delta-Mendota Water Authority	CASGEM
374061N1211212W001	MP45.78R	3/15/2012	00:00	111.400	0.000	111.400	153.500	153.000	42.100	110.900	ST - Steel tape measurement	0.1 Ft	San Luis & Delta-Mendota Water Authority	CASGEM
374061N1211212W001	MP45.78R	3/15/2013	00:00	118.590	0.000	118.590	153.500	153.000	34.910	118.090	ST - Steel tape measurement	0.1 Ft	San Luis & Delta-Mendota Water Authority	CASGEM
374061N1211212W001	MP45.78R	6/15/2013	00:00	121.920	0.000	121.920	153.580	153.000	31.660	121.340	ST - Steel tape measurement	0.1 Ft	San Luis & Delta-Mendota Water Authority	CASGEM
374061N1211212W001	MP45.78R	9/15/2013	00:00	133.240	0.000	133.240	153.580	153.000	20.340	132.660	ST - Steel tape measurement	0.1 Ft	San Luis & Delta-Mendota Water Authority	CASGEM
374061N1211212W001	MP45.78R	12/15/2013	00:00	112.570	0.000	112.570	153.580	153.000	41.010	111.990	ST - Steel tape measurement	0.1 Ft	San Luis & Delta-Mendota Water Authority	CASGEM
374061N1211212W001	MP45.78R	3/14/2014	00:00	125.220	0.000	125.220	153.580	153.000	28.360	124.640	ST - Steel tape measurement	0.1 Ft	San Luis & Delta-Mendota Water Authority	CASGEM
374061N1211212W001	MP45.78R	10/14/2014	00:00	141.730	0.000	141.730	153.580	153.000	11.850	141.150	ST - Steel tape measurement	0.1 Ft	San Luis & Delta-Mendota Water Authority	CASGEM
374316N1210994W001	P259-1	9/14/2011	07:50	73.900	0.000	73.900	82.180	83.000	8.280	74.720	ST - Steel tape measurement	0.01 Ft	San Luis & Delta-Mendota Water Authority	CASGEM
374316N1210994W001	P259-1	3/20/2012	07:45	100.000	32.750	67.250	82.180	83.000	14.930	68.070	ST - Steel tape measurement	0.01 Ft	San Luis & Delta-Mendota Water Authority	CASGEM
374316N1210994W001	P259-1	4/23/2012	07:32	100.000	31.380	68.620	82.180	83.000	13.560	69.440	ST - Steel tape measurement	0.01 Ft	San Luis & Delta-Mendota Water Authority	CASGEM
374316N1210994W001	P259-1	5/17/2012	09:20	100.000	2.670	97.330	82.180	83.000	-15.150	98.150	ST - Steel tape measurement	0.01 Ft	San Luis & Delta-Mendota Water Authority	CASGEM
374316N1210994W001	P259-1	10/13/2011	00:00	100.000	31.200	68.800	82.180	83.000	13.380	69.620	ST - Steel tape measurement	0.01 Ft	San Luis & Delta-Mendota Water Authority	CASGEM
374316N1210994W001	P259-1	11/16/2011	00:00	100.000	38.500	61.500	82.180	83.000	20.680	62.320	ST - Steel tape measurement	0.01 Ft	San Luis & Delta-Mendota Water Authority	CASGEM
374316N1210994W001	P259-1	6/11/2012	07:50	120.000	30.950	89.050	82.180	83.000	-6.870	89.870	ST - Steel tape measurement	0.01 Ft	San Luis & Delta-Mendota Water Authority	CASGEM
374316N1210994W001	P259-1	7/9/2012	08:37	120.000	7.710	112.290	82.180	83.000	-30.110	113.110	ST - Steel tape measurement	0.01 Ft	San Luis & Delta-Mendota Water Authority	CASGEM
374316N1210994W001	P259-1	8/6/2012	08:10	125.000	18.580	106.420	82.180	83.000	-24.240	107.240	ST - Steel tape measurement	0.01 Ft	San Luis & Delta-Mendota Water Authority	CASGEM
374316N1210994W001	P259-1	9/10/2012	07:50	125.000	28.410	96.590	82.180	83.000	-14.410	97.410	ST - Steel tape measurement	0.01 Ft	San Luis & Delta-Mendota Water Authority	CASGEM
374316N1210994W001	P259-1	10/23/2012	07:49	100.000	27.680	72.320	82.180	83.000	9.860	73.140	ST - Steel tape measurement	0.01 Ft	San Luis & Delta-Mendota Water Authority	CASGEM
374316N1210994W001	P259-1	11/19/2012	07:51	100.000	33.430	66.570	82.180	83.000	15.610	67.390	ST - Steel tape measurement	0.01 Ft	San Luis & Delta-Mendota Water Authority	CASGEM
374316N1210994W001	P259-1	12/12/2012	07:49	100.000	37.570	62.430	82.180	83.000	19.750	63.250	ST - Steel tape measurement	0.01 Ft	San Luis & Delta-Mendota Water Authority	CASGEM
374316N1210994W001	P259-1	1/14/2013	08:42	100.000	39.780	60.220	82.180	83.000	21.960	61.040	ST - Steel tape measurement	0.01 Ft	San Luis & Delta-Mendota Water Authority	CASGEM
374316N1210994W001	P259-1	4/2/2013	07:50	100.000	24.110	75.890	82.180	83.000	6.290	76.710	ST - Steel tape measurement	0.01 Ft	San Luis & Delta-Mendota Water Authority	CASGEM
374316N1210994W001	P259-1	3/12/2014	08:19	100.000	29.640	70.360	82.180	83.000	11.820	71.180	ST - Steel tape measurement	0.01 Ft	San Luis & Delta-Mendota Water Authority	CASGEM
374316N1210994W001	P259-1	12/9/2013	08:20	100.000	29.810	70.190	82.180	83.000	11.990	71.010	ST - Steel tape measurement	0.01 Ft	San Luis & Delta-Mendota Water Authority	CASGEM
374316N1210994W001	P259-1	4/16/2014	07:55	100.000	6.380	93.620	82.180	83.000	-11.440	94.440	ST - Steel tape measurement	0.01 Ft	San Luis & Delta-Mendota Water Authority	CASGEM
374316N1210994W001	P259-1	5/14/2014	08:25	125.000	18.720	106.280	82.180	83.000	-24.100	107.100	ST - Steel tape measurement	0.01 Ft	San Luis & Delta-Mendota Water Authority	CASGEM
374316N1210994W001	P259-1	6/16/2014	07:53	130.000	2.280	127.720	82.180	83.000	-45.540	128.540	ST - Steel tape measurement	0.01 Ft	San Luis & Delta-Mendota Water Authority	CASGEM
374316N1210994W001	P259-1	7/14/2014	07:45	150.000	21.010	128.990	82.180	83.000	-46.810	129.810	ST - Steel tape measurement	0.01 Ft	San Luis & Delta-Mendota Water Authority	CASGEM
374316N1210994W001	P259-1	8/11/2014	07:55	150.000	15.570	134.430	82.180	83.000	-52.250	135.250	ST - Steel tape measurement	0.01 Ft	San Luis & Delta-Mendota Water Authority	CASGEM
374316N1210994W001	P259-1	9/8/2014	07:54	150.000	21.980	128.020	82.180	83.000	-45.840	128.840	ST - Steel tape measurement	0.01 Ft	San Luis & Delta-Mendota Water Authority	CASGEM
374316N1210994W001	P259-1	10/14/2014	07:50	150.000	59.470	90.530	82.180	83.000	-8.350	91.350	ST - Steel tape measurement	0.01 Ft	San Luis & Delta-Mendota Water Authority	CASGEM
374316N1210994W001	P259-1	11/10/2014	07:05	145.000	60.130	84.870	82.180	83.000	-2.690	85.690	ST - Steel tape measurement	0.01 Ft	San Luis & Delta-Mendota Water Authority	CASGEM
374316N1210994W001	P259-1	12/22/2014	07:48	140.000	69.720	70.280	82.180	83.000	11.900	71.100	ST - Steel tape measurement	0.01 Ft	San Luis & Delta-Mendota Water Authority	CASGEM

374316N1210994W001	P259-1	1/21/2015	08:03	125,000	54,460		70,540	82,180	83,000	11,640	71,360	ST - Steel tape measurement	0.01 Ft	San Luis & Delta-Mendota Water Authority	CASGEM
374316N1210994W002	P259-2	9/14/2011	08:03	52,900	0,000		52,900	82,130	83,000	29,230	53,770	ST - Steel tape measurement	0.01 Ft	San Luis & Delta-Mendota Water Authority	CASGEM
374316N1210994W002	P259-2	3/20/2012	07:53	70,000	21,620		48,380	82,130	83,000	33,750	49,250	ST - Steel tape measurement	0.01 Ft	San Luis & Delta-Mendota Water Authority	CASGEM
374316N1210994W002	P259-2	4/23/2012	07:44	70,000	16,350		53,650	82,130	83,000	28,480	54,520	ST - Steel tape measurement	0.01 Ft	San Luis & Delta-Mendota Water Authority	CASGEM
374316N1210994W002	P259-2	5/17/2012	09:26	80,000	5,590		74,410	82,130	83,000	7,720	75,280	ST - Steel tape measurement	0.01 Ft	San Luis & Delta-Mendota Water Authority	CASGEM
374316N1210994W002	P259-2	10/13/2011	08:01	70,000	23,000		47,000	82,130	83,000	35,130	47,870	ST - Steel tape measurement	0.01 Ft	San Luis & Delta-Mendota Water Authority	CASGEM
374316N1210994W002	P259-2	11/16/2011	07:47	70,000	26,300		43,700	82,130	83,000	38,430	44,570	ST - Steel tape measurement	0.01 Ft	San Luis & Delta-Mendota Water Authority	CASGEM
374316N1210994W002	P259-2	6/11/2012	08:03	80,000	20,370		59,630	82,130	83,000	22,500	60,500	ST - Steel tape measurement	0.01 Ft	San Luis & Delta-Mendota Water Authority	CASGEM
374316N1210994W002	P259-2	7/9/2012	08:48	100,000	17,150		82,850	82,130	83,000	-0,720	83,720	ST - Steel tape measurement	0.01 Ft	San Luis & Delta-Mendota Water Authority	CASGEM
374316N1210994W002	P259-2	8/6/2012	08:20	100,000	25,390		74,610	82,130	83,000	7,520	75,480	ST - Steel tape measurement	0.01 Ft	San Luis & Delta-Mendota Water Authority	CASGEM
374316N1210994W002	P259-2	9/10/2012	07:59	100,000	31,640		68,360	82,130	83,000	13,770	69,230	ST - Steel tape measurement	0.01 Ft	San Luis & Delta-Mendota Water Authority	CASGEM
374316N1210994W002	P259-2	10/23/2012	07:56	100,000	52,190		47,810	82,130	83,000	34,320	48,680	ST - Steel tape measurement	0.01 Ft	San Luis & Delta-Mendota Water Authority	CASGEM
374316N1210994W002	P259-2	11/19/2012	08:05	100,000	54,390		45,610	82,130	83,000	36,520	46,480	ST - Steel tape measurement	0.01 Ft	San Luis & Delta-Mendota Water Authority	CASGEM
374316N1210994W002	P259-2	12/12/2012	08:01	100,000	56,530		43,470	82,130	83,000	38,660	44,340	ST - Steel tape measurement	0.01 Ft	San Luis & Delta-Mendota Water Authority	CASGEM
374316N1210994W002	P259-2	1/14/2013	08:49	100,000	57,970		42,030	82,130	83,000	40,100	42,900	ST - Steel tape measurement	0.01 Ft	San Luis & Delta-Mendota Water Authority	CASGEM
374316N1210994W002	P259-2	4/2/2013	08:01	100,000	47,760		52,240	82,130	83,000	29,890	53,110	ST - Steel tape measurement	0.01 Ft	San Luis & Delta-Mendota Water Authority	CASGEM
374316N1210994W002	P259-2	3/12/2014	08:28	100,000	51,920		48,080	82,130	83,000	34,050	48,950	ST - Steel tape measurement	0.01 Ft	San Luis & Delta-Mendota Water Authority	CASGEM
374316N1210994W002	P259-2	12/9/2013	08:29	100,000	51,410		48,590	82,130	83,000	33,540	49,460	ST - Steel tape measurement	0.01 Ft	San Luis & Delta-Mendota Water Authority	CASGEM
374316N1210994W002	P259-2	4/16/2014	08:06	100,000	37,740		62,260	82,130	83,000	19,870	63,130	ST - Steel tape measurement	0.01 Ft	San Luis & Delta-Mendota Water Authority	CASGEM
374316N1210994W002	P259-2	5/14/2014	08:38	100,000	22,600		77,400	82,130	83,000	4,730	78,270	ST - Steel tape measurement	0.01 Ft	San Luis & Delta-Mendota Water Authority	CASGEM
374316N1210994W002	P259-2	6/16/2014	08:00	100,000	5,770		94,230	82,130	83,000	-12,100	95,100	ST - Steel tape measurement	0.01 Ft	San Luis & Delta-Mendota Water Authority	CASGEM
374316N1210994W002	P259-2	7/14/2014	07:59	125,000	32,870		92,130	82,130	83,000	-10,000	93,000	ST - Steel tape measurement	0.01 Ft	San Luis & Delta-Mendota Water Authority	CASGEM
374316N1210994W002	P259-2	8/11/2014	08:06	125,000	24,310		100,690	82,130	83,000	-18,560	101,560	ST - Steel tape measurement	0.01 Ft	San Luis & Delta-Mendota Water Authority	CASGEM
374316N1210994W002	P259-2	9/8/2014	08:09	125,000	31,720		93,280	82,130	83,000	-11,150	94,150	ST - Steel tape measurement	0.01 Ft	San Luis & Delta-Mendota Water Authority	CASGEM
374316N1210994W002	P259-2	10/14/2014	08:01	100,000	37,880		62,120	82,130	83,000	20,010	62,990	ST - Steel tape measurement	0.01 Ft	San Luis & Delta-Mendota Water Authority	CASGEM
374316N1210994W002	P259-2	11/10/2014	08:06	100,000	38,880		61,120	82,130	83,000	21,010	61,990	ST - Steel tape measurement	0.01 Ft	San Luis & Delta-Mendota Water Authority	CASGEM
374316N1210994W002	P259-2	12/22/2014	08:05	100,000	48,270		51,730	82,130	83,000	30,400	52,600	ST - Steel tape measurement	0.01 Ft	San Luis & Delta-Mendota Water Authority	CASGEM
374316N1210994W002	P259-2	1/21/2015	08:14	100,000	48,440		51,560	82,130	83,000	30,570	52,430	ST - Steel tape measurement	0.01 Ft	San Luis & Delta-Mendota Water Authority	CASGEM
374316N1210994W003	P259-3	9/14/2011	08:11	39,700	0,000		39,700	82,170	83,000	42,470	40,530	ST - Steel tape measurement	0.01 Ft	San Luis & Delta-Mendota Water Authority	CASGEM
374316N1210994W003	P259-3	3/20/2012	08:01	50,000	16,280		33,720	82,170	83,000	48,450	34,550	ST - Steel tape measurement	0.01 Ft	San Luis & Delta-Mendota Water Authority	CASGEM
374316N1210994W003	P259-3	4/23/2012	07:51	50,000	15,910		34,090	82,170	83,000	48,080	34,920	ST - Steel tape measurement	0.01 Ft	San Luis & Delta-Mendota Water Authority	CASGEM
374316N1210994W003	P259-3	5/17/2012	09:33	60,000	17,860		42,140	82,170	83,000	40,030	42,970	ST - Steel tape measurement	0.01 Ft	San Luis & Delta-Mendota Water Authority	CASGEM
374316N1210994W003	P259-3	10/13/2011	08:08	50,000	18,400		31,600	82,170	83,000	50,570	32,430	ST - Steel tape measurement	0.01 Ft	San Luis & Delta-Mendota Water Authority	CASGEM
374316N1210994W003	P259-3	11/16/2011	00:00	50,000	18,700		31,300	82,170	83,000	50,870	32,130	ST - Steel tape measurement	0.01 Ft	San Luis & Delta-Mendota Water Authority	CASGEM
374316N1210994W003	P259-3	6/11/2012	08:11	60,000	24,310		35,690	82,170	83,000	46,480	36,520	ST - Steel tape measurement	0.01 Ft	San Luis & Delta-Mendota Water Authority	CASGEM
374316N1210994W003	P259-3	7/9/2012	08:57	80,000	37,710		42,290	82,170	83,000	39,880	43,120	ST - Steel tape measurement	0.01 Ft	San Luis & Delta-Mendota Water Authority	CASGEM
374316N1210994W003	P259-3	8/6/2012	08:28	80,000	42,330		37,670	82,170	83,000	44,500	38,500	ST - Steel tape measurement	0.01 Ft	San Luis & Delta-Mendota Water Authority	CASGEM

374316N1210994W003	P259-3	9/10/2012	08:05	80.000	40.580		39.420	82.170	83.000	42.750	40.250	ST - Steel tape measurement	0.01 Ft	San Luis & Delta-Mendota Water Authority	CASGEM
374316N1210994W003	P259-3	10/23/2012	08:05	80.000	46.120		33.880	82.170	83.000	48.290	34.710	ST - Steel tape measurement	0.01 Ft	San Luis & Delta-Mendota Water Authority	CASGEM
374316N1210994W003	P259-3	11/19/2012	08:14	80.000	46.470		33.530	82.170	83.000	48.640	34.360	ST - Steel tape measurement	0.01 Ft	San Luis & Delta-Mendota Water Authority	CASGEM
374316N1210994W003	P259-3	12/12/2012	08:11	80.000	46.680		33.320	82.170	83.000	48.850	34.150	ST - Steel tape measurement	0.01 Ft	San Luis & Delta-Mendota Water Authority	CASGEM
374316N1210994W003	P259-3	1/14/2013	08:57	80.000	46.940		33.060	82.170	83.000	49.110	33.890	ST - Steel tape measurement	0.01 Ft	San Luis & Delta-Mendota Water Authority	CASGEM
374316N1210994W003	P259-3	4/2/2013	08:10	80.000	44.490		35.510	82.170	83.000	46.660	36.340	ST - Steel tape measurement	0.01 Ft	San Luis & Delta-Mendota Water Authority	CASGEM
374316N1210994W003	P259-3	3/12/2014	08:39	100.000	64.760		35.240	82.170	83.000	46.930	36.070	ST - Steel tape measurement	0.01 Ft	San Luis & Delta-Mendota Water Authority	CASGEM
374316N1210994W003	P259-3	12/9/2013	08:38	100.000	65.300		34.700	82.170	83.000	47.470	35.530	ST - Steel tape measurement	0.01 Ft	San Luis & Delta-Mendota Water Authority	CASGEM
374316N1210994W003	P259-3	4/16/2014	08:14	100.000	62.000		38.000	82.170	83.000	44.170	38.830	ST - Steel tape measurement	0.01 Ft	San Luis & Delta-Mendota Water Authority	CASGEM
374316N1210994W003	P259-3	5/14/2014	08:46	100.000	55.650		44.350	82.170	83.000	37.820	45.180	ST - Steel tape measurement	0.01 Ft	San Luis & Delta-Mendota Water Authority	CASGEM
374316N1210994W003	P259-3	6/16/2014	08:10	100.000	53.750		46.250	82.170	83.000	35.920	47.080	ST - Steel tape measurement	0.01 Ft	San Luis & Delta-Mendota Water Authority	CASGEM
374316N1210994W003	P259-3	7/14/2014	08:12	100.000	56.250		43.750	82.170	83.000	38.420	44.580	ST - Steel tape measurement	0.01 Ft	San Luis & Delta-Mendota Water Authority	CASGEM
374316N1210994W003	P259-3	8/11/2014	08:13	100.000	52.300		47.700	82.170	83.000	34.470	48.530	ST - Steel tape measurement	0.01 Ft	San Luis & Delta-Mendota Water Authority	CASGEM
374316N1210994W003	P259-3	9/8/2014	08:16	100.000	52.220		47.780	82.170	83.000	34.390	48.610	ST - Steel tape measurement	0.01 Ft	San Luis & Delta-Mendota Water Authority	CASGEM
374316N1210994W003	P259-3	10/14/2014	08:15	100.000	59.450		40.550	82.170	83.000	41.620	41.380	ST - Steel tape measurement	0.01 Ft	San Luis & Delta-Mendota Water Authority	CASGEM
374316N1210994W003	P259-3	11/10/2014	08:12	100.000	59.520		40.480	82.170	83.000	41.690	41.310	ST - Steel tape measurement	0.01 Ft	San Luis & Delta-Mendota Water Authority	CASGEM
374316N1210994W003	P259-3	12/22/2014	08:16	100.000	62.120		37.880	82.170	83.000	44.290	38.710	ST - Steel tape measurement	0.01 Ft	San Luis & Delta-Mendota Water Authority	CASGEM
374316N1210994W003	P259-3	1/21/2015	08:24	100.000	62.390		37.610	82.170	83.000	44.560	38.440	ST - Steel tape measurement	0.01 Ft	San Luis & Delta-Mendota Water Authority	CASGEM



CROWS LANDING INDUSTRIAL BUSINESS PARK  
WATER SUPPLY (POTABLE & NON-POTABLE) INFRASTRUCTURE AND FACILITIES STUDY  
FEBRUARY 27, 2015 (UPDATED AUGUST 24, 2016)

MODEL EXPORT DATA

**Phase 1 Potable Water Average Day Demand Junctions**

<b>ID</b>	<b>Demand (gpm)</b>	<b>Elevation (ft)</b>	<b>Head (ft)</b>	<b>Pressure (psi)</b>
J27	11.91	193	304.21	48.19
J17	25.66	188	303.66	50.11
J18	8.97	179	302.65	53.58
J74	5.5	178	302.58	53.98
J62	10.06	178	302.63	54
J20	16.03	176	302.59	54.85
J19	11.76	173	302.59	56.15
J26	13.61	173	302.59	56.15
J76	4.51	171	302.58	57.01
J25	7.86	171	302.59	57.02
J72	13.2	171	302.62	57.03
J24	11.74	169	302.59	57.89
J66	14.56	169	302.61	57.89
J70	11.42	169	302.63	57.9
J64	7.13	169	302.67	57.92
J78	1.34	165	302.57	59.61
J30	13.58	165	302.58	59.61
J22	12.11	164	302.58	60.05
J80	13.61	164	302.59	60.05
J23	42.4	161	302.6	61.35
J60	15.42	157	302.58	63.08
J58	34.72	156	302.58	63.51
J56	30.67	156	302.59	63.52
J21	14.76	154	302.59	64.38
J50	23.86	146	302.29	67.72
J7	2.99	146	302.29	67.72
J82	44.81	145	302.32	68.16
J54	33.8	144	302.29	68.59

**Phase 1 Potable Water Maximum Day Demand Junctions**

<b>ID</b>	<b>Demand (gpm)</b>	<b>Elevation (ft)</b>	<b>Head (ft)</b>	<b>Pressure (psi)</b>
J27	23.83	193	302.13	47.28
J17	51.38	188	300.15	48.59
J18	17.96	179	296.48	50.91
J74	11	178	296.26	51.24
J62	20.15	178	296.43	51.32
J20	32.1	176	296.3	52.13
J19	23.55	173	296.29	53.42
J26	27.25	173	296.29	53.42
J76	9.03	171	296.24	54.27
J25	15.74	171	296.3	54.29
J72	26.43	171	296.39	54.33
J24	23.51	169	296.3	55.16
J66	29.15	169	296.34	55.18
J70	22.88	169	296.41	55.21
J64	14.28	169	296.56	55.27
J78	2.69	165	296.23	56.86
J30	27.19	165	296.25	56.87
J22	24.25	164	296.25	57.31
J80	27.26	164	296.3	57.33
J23	84.91	161	296.31	58.63
J60	30.88	157	296.26	60.34
J58	69.53	156	296.25	60.77
J56	61.42	156	296.27	60.78
J21	29.55	154	296.27	61.64
J50	47.78	146	295.18	64.64
J7	5.99	146	295.19	64.64
J82	89.62	145	295.29	65.12
J54	67.68	144	295.19	65.51

**Phase 1 Potable Water Peak Hour Demand Junctions**

<b>ID</b>	<b>Demand (gpm)</b>	<b>Elevation (ft)</b>	<b>Head (ft)</b>	<b>Pressure (psi)</b>
J18	35.89	179	274.29	41.29
J74	21.99	178	273.49	41.38
J62	40.28	178	274.1	41.64
J20	64.15	176	273.62	42.3
J17	102.7	188	287.5	43.12
J19	47.07	173	273.57	43.58
J26	54.47	173	273.58	43.58
J27	47.65	193	294.64	44.04
J76	18.06	171	273.42	44.38
J25	31.46	171	273.62	44.47
J72	52.84	171	273.93	44.6
J24	46.99	169	273.62	45.33
J66	58.27	169	273.78	45.4
J70	45.72	169	274.03	45.51
J64	28.54	169	274.57	45.75
J78	5.38	165	273.36	46.95
J30	54.34	165	273.45	46.99
J22	48.47	164	273.46	47.43
J80	54.49	164	273.62	47.5
J23	169.71	161	273.68	48.82
J60	61.72	157	273.49	50.48
J58	138.97	156	273.45	50.89
J56	122.76	156	273.52	50.92
J21	59.07	154	273.51	51.78
J50	95.51	146	269.59	53.55
J7	11.97	146	269.61	53.56
J82	179.23	145	269.98	54.15
J54	135.28	144	269.62	54.43

Phase 1 Potable Water Average Day Demand Pipes

ID	From Node	To Node	Length (ft)	Diameter (in)	Roughness	Flow (gpm)	Velocity (ft/s)	Headloss (ft)	HL/1000 (ft/k-ft)
P217	RES9010	J27	1,330.64	12	130	458.01	1.3	0.79	0.6
P183	J17	J27	962.49	12.00	130	-446.10	1.27	0.55	0.57
P181	J64	J17	1,946.12	12.00	130	-420.44	1.19	0.99	0.51
P161	J64	J70	445.7	12	130	168.21	0.48	0.04	0.09
P153	J66	J64	1,021.01	12.00	130	-132.22	0.38	0.06	0.06
P145	J18	J64	486.16	12.00	130	-112.87	0.32	0.02	0.04
P233	J78	J82	4,057.96	12	100	105.46	0.3	0.26	0.06
P143	J62	J18	375.06	12.00	130	-103.91	0.29	0.01	0.04
P141	J20	J62	1,161.91	12	130	-93.84	0.27	0.04	0.03
P163	J70	J72	329.98	12	130	79.05	0.22	0.01	0.02
P171	J70	J80	1,410.69	12	130	77.74	0.22	0.03	0.02
P165	J72	J26	1,651.26	12	130	65.85	0.19	0.03	0.02
P155	J66	J23	525.40	12	130	62.45	0.18	0.01	0.01
P179	J78	J80	1,259.60	12	130	-64.57	0.18	0.02	0.02
P235	J82	J54	1,206.50	12	100	60.65	0.17	0.03	0.02
P151	J56	J66	1,692.40	12	130	-55.21	0.16	0.02	0.01
P173	J26	J74	619.75	12	130	52.24	0.15	0.01	0.01
P175	J74	J76	598.96	12	130	46.75	0.13	0.01	0.01
P137	J20	J19	561.79	12	130	41.09	0.12	0	0.01
P177	J76	J78	677.06	12	130	42.23	0.12	0	0.01
P135	J21	J20	1,604.30	12	130	-36.73	0.1	0.01	0.01
P147	J58	J60	803.00	12	130	-31.08	0.09	0	0
P223	J22	J19	2,367.35	12	130	-29.33	0.08	0.01	0
P149	J60	J56	604.43	12	130	-24.54	0.07	0	0
P93	J50	J54	818.7	12	130	-23.86	0.07	0	0
P133	J60	J21	428.80	12	130	-21.97	0.06	0	0
P225	J23	J24	2,298.86	12	130	20.05	0.06	0	0
P131	J58	J22	1,453.22	12	130	-8.99	0.03	0	0
P129	J30	J58	1,932.13	12	130	-5.36	0.02	0	0
P167	J24	J25	309.06	12	130	8.31	0.02	0	0
P221	J30	J22	2,589.55	12.00	130	-8.22	0.02	0	0
P91	J7	J54	714.38	12	130	-2.99	0.01	0	0
P169	J25	J80	411.15	12	130	0.45	0	0	0

**Phase 1 Potable Water Maximum Day Demand Pipes**

<b>ID</b>	<b>From Node</b>	<b>To Node</b>	<b>Length (ft)</b>	<b>Diameter (in)</b>	<b>Roughness</b>	<b>Flow (gpm)</b>	<b>Velocity (ft/s)</b>	<b>Headloss (ft)</b>	<b>HL/1000 (ft/k-ft)</b>
P217	RES9010	J27	1,330.64	12	130	916.98	2.6	2.87	2.16
P183	J17	J27	962.49	12	130	-893.16	2.53	1.98	2.06
P181	J64	J17	1,946.12	12	130	-841.78	2.39	3.59	1.84
P161	J64	J70	445.70	12	130	336.77	0.96	0.15	0.34
P153	J66	J64	1,021.01	12	130	-264.73	0.75	0.22	0.22
P145	J18	J64	486.16	12	130	-226.01	0.64	0.08	0.16
P233	J78	J82	4,057.96	12.00	100	211.07	0.6	0.94	0.23
P143	J62	J18	375.06	12.00	130	-208.05	0.59	0.05	0.14
P141	J20	J62	1,161.91	12	130	-187.9	0.53	0.13	0.11
P163	J70	J72	329.98	12	130	158.26	0.45	0.03	0.08
P171	J70	J80	1,410.69	12	130	155.63	0.44	0.11	0.08
P165	J72	J26	1,651.26	12.00	130	131.82	0.37	0.1	0.06
P179	J78	J80	1,259.60	12	130	-129.22	0.37	0.07	0.06
P155	J66	J23	525.4	12	130	125.01	0.35	0.03	0.05
P235	J82	J54	1,206.50	12	100	121.45	0.34	0.1	0.08
P151	J56	J66	1,692.40	12	130	-110.57	0.31	0.07	0.04
P173	J26	J74	619.75	12	130	104.57	0.3	0.02	0.04
P175	J74	J76	598.96	12	130	93.57	0.27	0.02	0.03
P177	J76	J78	677.06	12	130	84.54	0.24	0.02	0.03
P137	J20	J19	561.79	12	130	82.27	0.23	0.01	0.02
P135	J21	J20	1,604.30	12	130	-73.53	0.21	0.03	0.02
P147	J58	J60	803	12	130	-62.25	0.18	0.01	0.01
P223	J22	J19	2,367.35	12	130	-58.72	0.17	0.03	0.01
P149	J60	J56	604.43	12.00	130	-49.15	0.14	0.01	0.01
P93	J50	J54	818.70	12.00	130	-47.78	0.14	0.01	0.01
P133	J60	J21	428.80	12	130	-43.98	0.12	0	0.01
P225	J23	J24	2,298.86	12.00	130	40.10	0.11	0.02	0.01
P131	J58	J22	1,453.22	12	130	-18.01	0.05	0	0
P167	J24	J25	309.06	12	130	16.59	0.05	0	0
P221	J30	J22	2,589.55	12	130	-16.46	0.05	0	0
P129	J30	J58	1,932.13	12	130	-10.73	0.03	0	0
P91	J7	J54	714.38	12	130	-5.99	0.02	0	0
P169	J25	J80	411.15	12	130	0.85	0	0	0

**Phase 1 Potable Water Peak Hour Demand Pipes**

ID	From Node	To Node	Length (ft)	Diameter (in)	Rough-		Flow (gpm)	Velocity (ft/s)	Headloss (ft)	HL/1000 (ft/k-ft)
					ness					
P217	RES9010	J27	1,330.64	12	130		1,832.99	5.2	10.36	7.79
P183	J17	J27	962.49	12	130		-1,785.34	5.06	7.14	7.41
P181	J64	J17	1,946.12	12	130		-1,682.63	4.77	12.93	6.64
P161	J64	J70	445.70	12	130		673.19	1.91	0.54	1.22
P153	J66	J64	1,021.01	12	130		-529.16	1.5	0.8	0.78
P145	J18	J64	486.16	12	130		-451.75	1.28	0.28	0.58
P233	J78	J82	4,057.96	12.00	100		421.98	1.2	3.38	0.83
P143	J62	J18	375.06	12.00	130		-415.86	1.18	0.19	0.5
P141	J20	J62	1,161.91	12	130		-375.57	1.07	0.48	0.41
P163	J70	J72	329.98	12	130		316.36	0.9	0.1	0.3
P171	J70	J80	1,410.69	12	130		311.1	0.88	0.41	0.29
P165	J72	J26	1,651.26	12.00	130		263.53	0.75	0.35	0.21
P179	J78	J80	1,259.60	12	130		-258.36	0.73	0.26	0.21
P155	J66	J23	525.4	12	130		249.9	0.71	0.1	0.19
P235	J82	J54	1,206.50	12	100		242.75	0.69	0.36	0.3
P151	J56	J66	1,692.40	12	130		-220.99	0.63	0.26	0.15
P173	J26	J74	619.75	12	130		209.05	0.59	0.09	0.14
P175	J74	J76	598.96	12	130		187.06	0.53	0.07	0.11
P177	J76	J78	677.06	12	130		169	0.48	0.06	0.09
P137	J20	J19	561.79	12	130		164.44	0.47	0.05	0.09
P135	J21	J20	1,604.30	12	130		-146.98	0.42	0.12	0.07
P147	J58	J60	803	12	130		-124.41	0.35	0.04	0.05
P223	J22	J19	2,367.35	12	130		-117.37	0.33	0.11	0.05
P149	J60	J56	604.43	12.00	130		-98.22	0.28	0.02	0.03
P93	J50	J54	818.70	12.00	130		-95.51	0.27	0.03	0.03
P133	J60	J21	428.80	12	130		-87.92	0.25	0.01	0.03
P225	J23	J24	2,298.86	12.00	130		80.19	0.23	0.05	0.02
P131	J58	J22	1,453.22	12	130		-36	0.1	0.01	0.01
P167	J24	J25	309.06	12	130		33.2	0.09	0	0
P221	J30	J22	2,589.55	12	130		-32.91	0.09	0.01	0
P129	J30	J58	1,932.13	12	130		-21.44	0.06	0	0
P91	J7	J54	714.38	12	130		-11.97	0.03	0	0
P169	J25	J80	411.15	12	130		1.74	0	0	0

**Phases 1 and 2 Potable Water Average Day Demand Junctions**

<b>ID</b>	<b>Demand (gpm)</b>	<b>Elevation (ft)</b>	<b>Head (ft)</b>	<b>Pressure (psi)</b>
J27	12.39	193	304.13	48.15
J17	23.74	188	303.54	50.06
J18	7.82	179	302.42	53.48
J74	5.04	178	302.34	53.88
J62	10.34	178	302.4	53.9
J20	13.91	176	302.36	54.75
J26	11.78	173	302.35	56.05
J19	10.76	173	302.36	56.05
J76	4.7	171	302.33	56.91
J25	6.9	171	302.36	56.92
J72	11.34	171	302.39	56.93
J24	10.51	169	302.36	57.78
J66	12.64	169	302.38	57.79
J70	9.92	169	302.4	57.8
J64	6.22	169	302.44	57.82
J78	1.32	165	302.33	59.5
J30	36.85	165	302.34	59.51
J22	11.51	164	302.35	59.95
J80	11.82	164	302.36	59.95
J23	36.83	161	302.37	61.26
J60	12.49	157	302.35	62.98
J58	33.05	156	302.35	63.41
J56	26.62	156	302.36	63.42
J21	12.82	154	302.35	64.28
J11	25.84	151	301.82	65.35
J9	19.72	150	301.82	65.79
J10	42.17	148	301.82	66.65
J48	34.72	147	301.82	67.08
J50	16.85	146	301.83	67.52
J7	3.42	146	301.84	67.52
J82	46.62	145	301.9	67.98
J54	29.47	144	301.84	68.39
J40	11.57	142	301.82	69.25
J6	18.44	141	301.86	69.7
J42	8.3	137	301.83	71.42
J5	10.2	131	301.87	74.04
J44	5.99	131	301.87	74.04
J46	2.06	131	301.9	74.05
J32	2.03	130	301.9	74.48
J3	12.37	130	301.9	74.48
J1	2.28	124	301.9	77.08
J2	12.67	124	301.9	77.08



**Phases 1 and 2 Potable Water Maximum Day Demand Junctions**

<b>ID</b>	<b>Demand (gpm)</b>	<b>Elevation (ft)</b>	<b>Head (ft)</b>	<b>Pressure (psi)</b>
J27	24.79	193	303.29	47.79
J17	47.48	188	302.13	49.45
J18	15.64	179	300.02	52.44
J62	20.67	178	299.97	52.85
J74	10.09	178	299.99	52.86
J20	27.82	176	299.86	53.67
J19	21.52	173	299.84	54.96
J26	23.56	173	300	55.03
J25	13.8	171	299.98	55.89
J76	9.39	171	299.99	55.89
J72	22.68	171	300.02	55.91
J66	25.27	169	299.96	56.74
J24	21.03	169	299.97	56.75
J70	19.83	169	300.03	56.78
J64	12.44	169	300.09	56.8
J30	73.69	165	299.79	58.4
J78	2.64	165	299.99	58.49
J22	23.02	164	299.8	58.84
J80	23.63	164	299.99	58.92
J23	73.66	161	299.96	60.21
J60	24.98	157	299.83	61.89
J58	66.11	156	299.8	62.31
J56	53.24	156	299.85	62.33
J21	25.65	154	299.83	63.19
J11	51.67	151	300.08	64.6
J9	39.43	150	300.13	65.05
J10	84.33	148	300.03	65.88
J48	69.43	147	300.02	66.31
J7	6.83	146	299.98	66.72
J50	33.7	146	299.99	66.73
J82	93.24	145	299.98	67.15
J54	58.93	144	299.98	67.59
J40	23.14	142	300.13	68.52
J6	36.88	141	300.63	69.17
J42	16.61	137	300.25	70.74
J5	20.39	131	300.64	73.51
J44	11.97	131	300.65	73.51
J46	4.11	131	300.94	73.64
J32	4.07	130	300.65	73.94
J3	24.73	130	300.89	74.05
J1	4.55	124	300.68	76.55
J2	25.35	124	300.78	76.6

**Phases 1 and 2 Potable Water Peak Hour Demand Junctions**

<b>ID</b>	<b>Demand (gpm)</b>	<b>Elevation (ft)</b>	<b>Head (ft)</b>	<b>Pressure (psi)</b>
J27	49.55	193	300.23	46.46
J17	94.92	188	297.04	47.24
J18	31.26	179	291.28	48.65
J62	41.33	178	291.12	49.02
J74	20.16	178	291.4	49.14
J20	55.62	176	290.72	49.71
J19	43.03	173	290.67	50.98
J26	47.11	173	291.4	51.3
J25	27.58	171	291.3	52.12
J76	18.77	171	291.4	52.17
J72	45.35	171	291.42	52.18
J66	50.53	169	291.14	52.92
J24	42.04	169	291.27	52.98
J70	39.64	169	291.43	53.05
J64	24.88	169	291.53	53.09
J30	147.32	165	290.49	54.37
J78	5.28	165	291.41	54.77
J22	46.02	164	290.54	54.83
J80	47.24	164	291.35	55.18
J23	147.26	161	291.14	56.39
J60	49.94	157	290.64	57.9
J58	132.16	156	290.53	58.29
J56	106.44	156	290.7	58.37
J21	51.27	154	290.64	59.21
J11	103.3	151	292.87	61.47
J9	78.84	150	293.11	62.01
J10	168.61	148	292.61	62.66
J48	138.81	147	292.52	63.05
J7	13.66	146	292.06	63.29
J50	67.38	146	292.22	63.36
J82	186.36	145	291.96	63.68
J54	117.81	144	292.06	64.15
J40	46.25	142	293.14	65.49
J6	73.74	141	295.62	67
J42	33.2	137	293.73	67.91
J5	40.77	131	295.65	71.34
J44	23.93	131	295.67	71.35
J32	8.13	130	295.56	71.74
J46	8.23	131	297.04	71.95
J3	49.45	130	296.8	72.27
J1	9.11	124	295.73	74.41
J2	50.67	124	296.25	74.64

**Phases 1 and 2 Potable Water Average Day Demand Pipes**

ID	From Node	To Node	Length (ft)	Diameter (in)	Roughness	Flow (gpm)	Velocity (ft/s)	Headloss (ft)	HL/1000 (ft/k-ft)
P217	RES9010	J27	1,330.64	12	130	479.72	1.36	0.87	0.65
P183	J17	J27	962.49	12	130	-467.32	1.33	0.6	0.62
P181	J64	J17	1,946.12	12	130	-443.58	1.26	1.09	0.56
P161	J64	J70	445.70	12	130	181.70	0.52	0.05	0.11
P219	RES9008	J46	665.41	12	100	166.30	0.47	0.1	0.15
P233	J78	J82	4,057.96	12	100	138.4	0.39	0.43	0.11
P153	J66	J64	1,021.01	12	130	-138.16	0.39	0.07	0.06
P59	J46	J44	515.4	12	130	136.29	0.39	0.03	0.06
P145	J18	J64	486.16	12	130	-117.5	0.33	0.02	0.05
P143	J62	J18	375.06	12	130	-109.68	0.31	0.02	0.04
P61	J44	J42	958.43	12	130	101.66	0.29	0.04	0.04
P141	J20	J62	1,161.91	12	130	-99.34	0.28	0.04	0.04
P235	J82	J54	1,206.50	12	100	90.38	0.26	0.06	0.05
P163	J70	J72	329.98	12	130	87.33	0.25	0.01	0.03
P179	J78	J80	1,259.60	12	130	-85.25	0.24	0.03	0.03
P171	J70	J80	1,410.69	12	130	84.45	0.24	0.04	0.03
P165	J72	J26	1,651.26	12	130	75.99	0.22	0.04	0.02
P155	J66	J23	525.40	12	130	66.85	0.19	0.01	0.02
P173	J26	J74	619.75	12	130	64.21	0.18	0.01	0.02
P175	J74	J76	598.96	12	130	59.16	0.17	0.01	0.01
P151	J56	J66	1,692.40	12	130	-58.67	0.17	0.02	0.01
P93	J50	J54	818.70	12	130	-57.5	0.16	0.01	0.01
P177	J76	J78	677.06	12	130	54.47	0.15	0.01	0.01
P67	J40	J42	1,035.34	12	130	-53.45	0.15	0.01	0.01
P137	J20	J19	561.79	12	130	46.61	0.13	0	0.01
P147	J58	J60	803.00	12	130	-45.56	0.13	0.01	0.01
P73	J40	J11	559.91	12	130	41.88	0.12	0	0.01
P87	J48	J50	980.29	12	130	-40.65	0.12	0.01	0.01
P69	J42	J9	1,285.03	12	130	39.91	0.11	0.01	0.01
P135	J21	J20	1,604.30	12	130	-38.83	0.11	0.01	0.01
P223	J22	J19	2,367.35	12	130	-35.85	0.1	0.01	0.01
P149	J60	J56	604.43	12	130	-32.05	0.09	0	0
P225	J23	J24	2,298.86	12	130	30.02	0.09	0.01	0
P63	J44	J5	574.96	12	130	28.64	0.08	0	0
P57	J3	J46	704.66	12	130	-27.96	0.08	0	0
P75	J10	J48	1,660.98	12	130	-26.12	0.07	0	0
P133	J60	J21	428.80	12	130	-26.00	0.07	0	0
P71	J9	J48	1,871.25	12	130	20.19	0.06	0	0
P167	J24	J25	309.06	12	130	19.51	0.06	0	0
P129	J30	J58	1,932.13	12	130	-19.36	0.05	0	0
P79	J5	J6	1,278.10	12	130	18.44	0.05	0	0
P221	J30	J22	2,589.55	12	130	-17.49	0.05	0	0
P77	J11	J10	981.29	12	130	16.05	0.05	0	0
P55	J2	J3	2,071.12	12	130	-15.59	0.04	0	0
P169	J25	J80	411.15	12	130	12.61	0.04	0	0
P131	J58	J22	1,453.22	12	130	-6.85	0.02	0	0
P91	J7	J54	714.38	12	130	-3.42	0.01	0	0
P53	J1	J2	2,835.47	12	130	-2.91	0.01	0	0
P237	J82	J32	13,724.69	12	100	1.4	0	0	0
P99	J1	J32	995.3	12	130	0.64	0	0	0

**Phases 1 and 2 Potable Water Maximum Day Demand Pipes**

ID	From Node	To Node	Length (ft)	Diameter (in)	Roughness	Flow (gpm)	Velocity (ft/s)	Headloss (ft)	HL/1000 (ft/k-ft)
P217	RES9010	J27	1,330.64	12	130	693.42	1.97	1.71	1.29
P183	J17	J27	962.49	12	130	-668.63	1.9	1.16	1.2
P181	J64	J17	1,946.12	12	130	-621.15	1.76	2.04	1.05
P219	RES9008	J46	665.41	12	100	598.58	1.7	1.06	1.59
P59	J46	J44	515.4	12	130	445.26	1.26	0.29	0.57
P61	J44	J42	958.43	12	130	376.01	1.07	0.4	0.41
P145	J18	J64	486.16	12	130	-211.69	0.6	0.07	0.14
P161	J64	J70	445.7	12	130	199.43	0.57	0.06	0.13
P153	J66	J64	1,021.01	12	130	-197.59	0.56	0.13	0.13
P143	J62	J18	375.06	12	130	-196.05	0.56	0.05	0.12
P67	J40	J42	1,035.34	12	130	-190.89	0.54	0.12	0.12
P141	J20	J62	1,161.91	12	130	-175.38	0.5	0.12	0.1
P69	J42	J9	1,285.03	12	130	168.51	0.48	0.12	0.09
P73	J40	J11	559.91	12	130	167.76	0.48	0.05	0.09
P57	J3	J46	704.66	12	130	-149.21	0.42	0.05	0.07
P151	J56	J66	1,692.40	12	130	-140.65	0.4	0.11	0.07
P71	J9	J48	1,871.25	12	130	129.08	0.37	0.11	0.06
P55	J2	J3	2,071.12	12	130	-124.47	0.35	0.11	0.05
P77	J11	J10	981.29	12	130	116.09	0.33	0.05	0.05
P53	J1	J2	2,835.47	12	130	-99.12	0.28	0.1	0.04
P147	J58	J60	803	12	130	-98.21	0.28	0.03	0.03
P99	J1	J32	995.30	12	130	94.57	0.27	0.03	0.03
P171	J70	J80	1,410.69	12	130	92.53	0.26	0.04	0.03
P87	J48	J50	980.29	12	130	91.41	0.26	0.03	0.03
P237	J82	J32	13,724.69	12	100	-90.50	0.26	0.66	0.05
P149	J60	J56	604.43	12	130	-87.41	0.25	0.02	0.03
P163	J70	J72	329.98	12	130	87.07	0.25	0.01	0.03
P137	J20	J19	561.79	12	130	86.12	0.24	0.02	0.03
P169	J25	J80	411.15	12	130	-76.81	0.22	0.01	0.02
P223	J22	J19	2,367.35	12	130	-64.6	0.18	0.04	0.02
P165	J72	J26	1,651.26	12	130	64.39	0.18	0.03	0.02
P167	J24	J25	309.06	12	130	-63.01	0.18	0	0.02
P135	J21	J20	1,604.30	12	130	-61.44	0.17	0.02	0.01
P93	J50	J54	818.70	12	130	57.7	0.16	0.01	0.01
P63	J44	J5	574.96	12	130	57.28	0.16	0.01	0.01
P225	J23	J24	2,298.86	12	130	-41.98	0.12	0.02	0.01
P173	J26	J74	619.75	12	130	40.83	0.12	0	0.01
P129	J30	J58	1,932.13	12	130	-39.43	0.11	0.01	0.01
P79	J5	J6	1,278.10	12	130	36.88	0.1	0.01	0.01
P133	J60	J21	428.80	12	130	-35.79	0.1	0	0.01
P221	J30	J22	2,589.55	12	130	-34.26	0.1	0.01	0
P75	J10	J48	1,660.98	12	130	31.75	0.09	0.01	0
P155	J66	J23	525.4	12	130	31.67	0.09	0	0
P175	J74	J76	598.96	12	130	30.74	0.09	0	0
P177	J76	J78	677.06	12	130	21.35	0.06	0	0
P233	J78	J82	4,057.96	12	100	10.8	0.03	0	0
P235	J82	J54	1,206.50	12	100	8.06	0.02	0	0
P179	J78	J80	1,259.60	12	130	7.91	0.02	0	0
P131	J58	J22	1,453.22	12	130	-7.32	0.02	0	0
P91	J7	J54	714.38	12	130	-6.83	0.02	0	0

**Phases 1 and 2 Potable Water Peak Hour Demand Pipes**

ID	From Node	To Node	Length (ft)	Diameter (in)	Roughness	Flow (gpm)	Velocity (ft/s)	Headloss (ft)	HL/1000 (ft/k-ft)
P219	RES9008	J46	665.41	12	100	1,376.91	3.91	4.96	7.45
P217	RES9010	J27	1,330.64	12	130	1,206.06	3.42	4.77	3.59
P183	J17	J27	962.49	12	130	-1,156.51	3.28	3.19	3.32
P181	J64	J17	1,946.12	12	130	-1,061.59	3.01	5.51	2.83
P59	J46	J44	515.4	12	130	1,025.42	2.91	1.37	2.66
P61	J44	J42	958.43	12	130	886.97	2.52	1.95	2.03
P67	J40	J42	1,035.34	12	130	-447.6	1.27	0.59	0.57
P145	J18	J64	486.16	12	130	-414.38	1.18	0.24	0.5
P69	J42	J9	1,285.03	12	130	406.18	1.15	0.61	0.48
P73	J40	J11	559.91	12	130	401.34	1.14	0.26	0.47
P143	J62	J18	375.06	12	130	-383.12	1.09	0.16	0.43
P153	J66	J64	1,021.01	12	130	-359.04	1.02	0.39	0.38
P57	J3	J46	704.66	12	130	-343.27	0.97	0.25	0.35
P141	J20	J62	1,161.91	12	130	-341.78	0.97	0.4	0.35
P71	J9	J48	1,871.25	12	130	327.34	0.93	0.6	0.32
P87	J48	J50	980.29	12	130	317.97	0.9	0.3	0.3
P77	J11	J10	981.29	12	130	298.04	0.85	0.26	0.27
P55	J2	J3	2,071.12	12	130	-293.82	0.83	0.54	0.26
P151	J56	J66	1,692.40	12	130	-290.03	0.82	0.43	0.26
P161	J64	J70	445.7	12	130	263.3	0.75	0.1	0.21
P93	J50	J54	818.7	12	130	250.59	0.71	0.16	0.2
P53	J1	J2	2,835.47	12	130	-243.15	0.69	0.52	0.18
P99	J1	J32	995.30	12	130	234.04	0.66	0.17	0.17
P237	J82	J32	13,724.69	12	100	-225.91	0.64	3.6	0.26
P147	J58	J60	803	12	130	-198.87	0.56	0.1	0.13
P169	J25	J80	411.15	12	130	-198.40	0.56	0.05	0.13
P149	J60	J56	604.43	12	130	-183.59	0.52	0.07	0.11
P167	J24	J25	309.06	12	130	-170.82	0.48	0.03	0.1
P137	J20	J19	561.79	12	130	169.66	0.48	0.05	0.09
P233	J78	J82	4,057.96	12	100	-158.66	0.45	0.55	0.14
P75	J10	J48	1,660.98	12	130	129.43	0.37	0.1	0.06
P171	J70	J80	1,410.69	12	130	129.31	0.37	0.08	0.06
P225	J23	J24	2,298.86	12	130	-128.78	0.37	0.13	0.06
P223	J22	J19	2,367.35	12	130	-126.64	0.36	0.13	0.06
P235	J82	J54	1,206.50	12	100	-119.12	0.34	0.1	0.08
P135	J21	J20	1,604.30	12	130	-116.50	0.33	0.08	0.05
P179	J78	J80	1,259.60	12	130	116.33	0.33	0.06	0.05
P63	J44	J5	574.96	12	130	114.51	0.32	0.03	0.05
P163	J70	J72	329.98	12	130	94.34	0.27	0.01	0.03
P129	J30	J58	1,932.13	12	130	-79	0.22	0.04	0.02
P79	J5	J6	1,278.10	12	130	73.74	0.21	0.03	0.02
P221	J30	J22	2,589.55	12	130	-68.32	0.19	0.05	0.02
P133	J60	J21	428.8	12	130	-65.22	0.19	0.01	0.02
P165	J72	J26	1,651.26	12	130	49	0.14	0.02	0.01
P177	J76	J78	677.06	12	130	-37.05	0.11	0	0.01
P155	J66	J23	525.40	12	130	18.48	0.05	0	0
P175	J74	J76	598.96	12	130	-18.27	0.05	0	0
P91	J7	J54	714.38	12	130	-13.66	0.04	0	0
P131	J58	J22	1,453.22	12	130	-12.3	0.03	0	0
P173	J26	J74	619.75	12	130	1.89	0.01	0	0

**Phases 1,2 and 3 Potable Water Average Day Demand Junctions**

<b>ID</b>	<b>Demand (gpm)</b>	<b>Elevation (ft)</b>	<b>Head (ft)</b>	<b>Pressure (psi)</b>
J1	9.5	124	302.14	77.19
J10	46.73	148	302.04	66.74
J11	30.81	151	302.04	65.45
J12	18.28	139	302.07	70.66
J13	18.05	134	302.09	72.83
J14	14	137	302.15	71.56
J15	14.31	129	302.18	75.04
J16	13	135	302.52	72.59
J17	26.3	188	303.52	50.06
J18	8.68	179	302.4	53.47
J19	12.09	173	302.33	56.04
J2	16.4	124	302.08	77.16
J20	15.41	176	302.34	54.74
J21	14.2	154	302.33	64.27
J22	12.96	164	302.32	59.93
J23	40.83	161	302.36	61.25
J24	11.66	169	302.36	57.78
J25	7.64	171	302.36	56.92
J26	12.99	173	302.35	56.05
J27	12.78	193	304.13	48.15
J28	18.66	130	302.07	74.56
J3	14.14	130	302.05	74.55
J30	44.93	165	302.31	59.5
J32	8.66	130	302.21	74.62
J34	23.84	136	302.16	72
J36	10.93	134	302.13	72.85
J38	15.23	132	302.11	73.71
J4	19.31	124	302.12	77.18
J40	26.13	142	302.05	69.35
J42	13.97	137	302.05	71.52
J44	7.45	131	302.05	74.11
J46	8.07	131	302.05	74.11
J48	34.89	147	302.04	67.18
J5	11.29	131	302.04	74.11
J50	17.49	146	302.04	67.61
J52	11.84	144	302.04	68.48
J54	32.96	144	302.04	68.48
J56	29.36	156	302.33	63.41
J58	36.79	156	302.32	63.4
J6	16.28	141	302.04	69.78
J60	13.89	157	302.33	62.97
J62	11.49	178	302.39	53.9
J64	6.8	169	302.43	57.82
J66	13.84	169	302.36	57.79
J7	3.42	146	302.04	67.61
J70	10.98	169	302.39	57.8
J72	12.58	171	302.38	56.93
J74	5.59	178	302.35	53.88
J76	4.84	171	302.34	56.91
J78	1.46	165	302.34	59.51
J8	5.81	148	302.04	66.74
J80	13.09	164	302.36	59.95
J82	48.07	145	302.1	68.07
J9	19.35	150	302.04	65.88

**Phases 1,2 and 3 Potable Water Maximum Day Demand Junctions**

<b>ID</b>	<b>Demand (gpm)</b>	<b>Elevation (ft)</b>	<b>Head (ft)</b>	<b>Pressure (psi)</b>
J1	19.02	124	301.47	76.9
J10	93.51	148	301.01	66.3
J11	61.65	151	301.08	65.03
J12	36.58	139	301.24	70.3
J13	36.13	134	301.3	72.49
J14	28.02	137	301.45	71.26
J15	28.64	129	301.49	74.74
J16	26.01	135	302.1	72.41
J17	52.62	188	302.4	49.57
J18	17.36	179	300.52	52.66
J19	24.2	173	300.31	55.16
J2	32.82	124	301.44	76.88
J20	30.83	176	300.33	53.87
J21	28.41	154	300.3	63.39
J22	25.93	164	300.26	59.04
J23	81.71	161	300.48	60.44
J24	23.33	169	300.53	56.99
J25	15.29	171	300.54	56.13
J26	25.99	173	300.58	55.28
J27	25.56	193	303.45	47.86
J28	37.35	130	301.43	74.28
J3	28.29	130	301.44	74.28
J30	89.92	165	300.24	58.6
J32	17.33	130	301.55	74.33
J34	47.71	136	301.45	71.69
J36	21.87	134	301.42	72.54
J38	30.47	132	301.43	73.41
J4	38.64	124	301.44	76.88
J40	52.29	142	301.16	68.96
J42	27.96	137	301.18	71.14
J44	14.91	131	301.25	73.77
J46	16.14	131	301.44	73.85
J48	69.81	147	300.99	66.72
J5	22.6	131	301.17	73.74
J50	35	146	300.95	67.14
J52	23.7	144	300.95	68.01
J54	65.95	144	300.92	67.99
J56	58.75	156	300.32	62.54
J58	73.61	156	300.26	62.51
J6	32.58	141	301.04	69.35
J60	27.79	157	300.3	62.09
J62	22.99	178	300.47	53.07
J64	13.61	169	300.61	57.03
J66	27.69	169	300.48	56.97
J7	6.85	146	300.93	67.13
J70	21.97	169	300.58	57.01
J72	25.17	171	300.58	56.15
J74	11.18	178	300.58	53.11
J76	9.68	171	300.58	56.15
J78	2.92	165	300.58	58.75
J8	11.62	148	300.95	66.27
J80	26.19	164	300.56	59.17
J82	96.14	145	300.84	67.52
J9	38.72	150	301.08	65.46

**Phases 1,2 and 3 Potable Water Peak Hour Demand Junctions**

<b>ID</b>	<b>Demand (gpm)</b>	<b>Elevation (ft)</b>	<b>Head (ft)</b>	<b>Pressure (psi)</b>
J1	38.04	124	297.75	75.29
J10	187.02	148	295.87	64.07
J11	123.31	151	296.18	62.91
J12	73.16	139	296.83	68.39
J13	72.25	134	297.06	70.65
J14	56.05	137	297.58	69.58
J15	57.29	129	297.69	73.09
J16	52.03	135	299.24	71.16
J17	105.24	188	297.39	47.4
J18	34.72	179	291.97	48.95
J19	48.4	173	291.2	51.22
J2	65.65	124	297.76	75.29
J20	61.66	176	291.27	49.95
J21	56.81	154	291.18	59.44
J22	51.86	164	291.03	55.04
J23	163.42	161	291.83	56.69
J24	46.66	169	292.05	53.32
J25	30.58	171	292.1	52.47
J26	51.97	173	292.25	51.67
J27	51.12	193	300.43	46.55
J28	74.7	130	297.7	72.67
J3	56.58	130	297.82	72.72
J30	179.83	165	290.97	54.58
J32	34.65	130	297.86	72.73
J34	95.41	136	297.53	69.99
J36	43.74	134	297.51	70.85
J38	60.93	132	297.6	71.76
J4	77.27	124	297.64	75.24
J40	104.58	142	296.51	66.95
J42	55.91	137	296.63	69.17
J44	29.82	131	296.96	71.91
J46	32.28	131	297.88	72.31
J48	139.63	147	295.75	64.45
J5	45.2	131	296.63	71.77
J50	69.99	146	295.53	64.79
J52	47.4	144	295.55	65.67
J54	131.91	144	295.34	65.58
J56	117.49	156	291.26	58.61
J58	147.23	156	291.03	58.51
J6	65.16	141	296.01	67.17
J60	55.58	157	291.17	58.14
J62	45.98	178	291.77	49.3
J64	27.22	169	292.26	53.41
J66	55.38	169	291.83	53.22
J7	13.7	146	295.43	64.75
J70	43.95	169	292.23	53.4
J72	50.34	171	292.23	52.53
J74	22.35	178	292.27	49.51
J76	19.37	171	292.3	52.56
J78	5.85	165	292.34	55.18
J8	23.25	148	295.54	63.93
J80	52.37	164	292.18	55.54
J82	192.28	145	294.71	64.87
J9	77.44	150	296.17	63.34



**Phases 1,2 and 3 Potable Water Average Day Demand Pipes**

ID	From Node	To Node	Length (ft)	Diameter		Flow (gpm)	Velocity (ft/s)	Headloss (ft)	HL/1000 (ft/k-ft)
				(in)	Roughness				
P101	J32	J16	1,027.54	12	130	-313.79	0.89	0.3	0.3
P105	J34	J36	958.33	12	130	98.05	0.28	0.03	0.03
P107	J36	J14	730.64	12	130	-93.12	0.26	0.02	0.03
P109	J14	J15	711.86	12	130	-107.12	0.3	0.03	0.04
P111	J15	J32	676.29	12	130	-121.44	0.34	0.03	0.05
P113	J1	J4	1,145.92	12	130	63.77	0.18	0.02	0.02
P115	J4	J38	1,133.89	12	130	44.46	0.13	0.01	0.01
P117	J38	J36	723.34	12	130	-73.03	0.21	0.01	0.02
P119	J36	J13	957.7	12	130	107.21	0.3	0.04	0.04
P121	J13	J12	716.15	12	130	89.16	0.25	0.02	0.03
P123	J12	J42	937.53	12	130	70.88	0.2	0.02	0.02
P125	J38	J28	1,127.74	12	130	102.27	0.29	0.04	0.04
P127	J28	J46	953.64	12	130	83.6	0.24	0.02	0.03
P129	J30	J58	1,932.13	12	130	-23.93	0.07	0	0
P131	J58	J22	1,453.22	12	130	-5.7	0.02	0	0
P133	J60	J21	428.8	12	130	-26.16	0.07	0	0
P135	J21	J20	1,604.30	12	130	-40.35	0.11	0.01	0.01
P137	J20	J19	561.79	12	130	51.75	0.15	0.01	0.01
P141	J20	J62	1,161.91	12	130	-107.52	0.31	0.05	0.04
P143	J62	J18	375.06	12	130	-119.01	0.34	0.02	0.05
P145	J18	J64	486.16	12	130	-127.68	0.36	0.03	0.06
P147	J58	J60	803	12	130	-55.02	0.16	0.01	0.01
P149	J60	J56	604.43	12	130	-42.74	0.12	0	0.01
P151	J56	J66	1,692.40	12	130	-72.1	0.2	0.03	0.02
P153	J66	J64	1,021.01	12	130	-139.72	0.4	0.07	0.07
P155	J66	J23	525.4	12	130	53.78	0.15	0.01	0.01
P161	J64	J70	445.7	12	130	169.07	0.48	0.04	0.09
P163	J70	J72	329.98	12	130	78.04	0.22	0.01	0.02
P165	J72	J26	1,651.26	12	130	65.46	0.19	0.03	0.02
P167	J24	J25	309.06	12	130	1.29	0	0	0
P169	J25	J80	411.15	12	130	-6.35	0.02	0	0
P171	J70	J80	1,410.69	12	130	80.06	0.23	0.03	0.02
P173	J26	J74	619.75	12	130	52.47	0.15	0.01	0.01
P175	J74	J76	598.96	12	130	46.89	0.13	0.01	0.01
P177	J76	J78	677.06	12	130	42.04	0.12	0	0.01
P179	J78	J80	1,259.60	12	130	-60.62	0.17	0.02	0.01
P181	J64	J17	1,946.12	12	130	-443.27	1.26	1.09	0.56
P183	J17	J27	962.49	12	130	-469.57	1.33	0.6	0.63
P197	J34	J40	2,632.93	12	130	108.39	0.31	0.11	0.04
P213	J16	J34	2,141.15	12	130	230.29	0.65	0.36	0.17
P217	RES9010	J27	1,330.64	12	130	482.35	1.37	0.87	0.66
P219	RES9008	J46	665.41	12	100	-109.4	0.31	0.05	0.07
P221	J30	J22	2,589.55	12	130	-21	0.06	0.01	0
P223	J22	J19	2,367.35	12	130	-39.66	0.11	0.02	0.01
P225	J23	J24	2,298.86	12	130	12.95	0.04	0	0

P233	J78	J82	4,057.96	12	100	101.2	0.29	0.24	0.06
P235	J82	J54	1,206.50	12	100	88.28	0.25	0.06	0.05
P237	J82	J32	13,724.69	12	100	-35.14	0.1	0.11	0.01
P245	J16	RES9022	563.36	12	130	-557.07	1.58	0.48	0.86
P53	J1	J2	2,835.47	12	130	75.27	0.21	0.06	0.02
P55	J2	J3	2,071.12	12	130	58.87	0.17	0.03	0.01
P57	J3	J46	704.66	12	130	44.74	0.13	0.01	0.01
P59	J46	J44	515.4	12	130	10.88	0.03	0	0
P61	J44	J42	958.43	12	130	-30.83	0.09	0	0
P63	J44	J5	574.96	12	130	34.25	0.1	0	0
P67	J40	J42	1,035.34	12	130	15.15	0.04	0	0
P69	J42	J9	1,285.03	12	130	41.23	0.12	0.01	0.01
P71	J9	J48	1,871.25	12	130	21.88	0.06	0	0
P73	J40	J11	559.91	12	130	67.12	0.19	0.01	0.02
P75	J10	J48	1,660.98	12	130	-10.42	0.03	0	0
P77	J11	J10	981.29	12	130	36.31	0.1	0.01	0.01
P79	J5	J6	1,278.10	12	130	22.96	0.07	0	0
P81	J6	J52	1,314.19	12	130	6.68	0.02	0	0
P83	J52	J8	376.91	12	130	14.08	0.04	0	0
P85	J8	J50	455.92	12	130	8.28	0.02	0	0
P87	J48	J50	980.29	12	130	-23.43	0.07	0	0
P89	J52	J7	903.39	12	130	-19.25	0.05	0	0
P91	J7	J54	714.38	12	130	-22.67	0.06	0	0
P93	J50	J54	818.7	12	130	-32.64	0.09	0	0
P99	J1	J32	995.3	12	130	-148.55	0.42	0.07	0.07

**Phases 1,2 and 3 Potable Water Maximum Day Demand Pipes**

ID	From Node	To Node	Length (ft)	Diameter		Roughness	Flow (gpm)	Velocity (ft/s)	Headloss (ft)	HL/1000 (ft/k-ft)
				(in)						
P101	J32	J16	1,027.54	12		130	-432.32	1.23	0.55	0.54
P105	J34	J36	958.33	12		130	87.34	0.25	0.03	0.03
P107	J36	J14	730.64	12		130	-104.73	0.3	0.03	0.04
P109	J14	J15	711.86	12		130	-132.75	0.38	0.04	0.06
P111	J15	J32	676.29	12		130	-161.39	0.46	0.06	0.09
P113	J1	J4	1,145.92	12		130	87.94	0.25	0.03	0.03
P115	J4	J38	1,133.89	12		130	49.3	0.14	0.01	0.01
P117	J38	J36	723.34	12		130	29.89	0.08	0	0
P119	J36	J13	957.7	12		130	200.08	0.57	0.12	0.13
P121	J13	J12	716.15	12		130	163.96	0.47	0.06	0.09
P123	J12	J42	937.53	12		130	127.37	0.36	0.05	0.06
P125	J38	J28	1,127.74	12		130	-11.05	0.03	0	0
P127	J28	J46	953.64	12		130	-48.4	0.14	0.01	0.01
P129	J30	J58	1,932.13	12		130	-48.34	0.14	0.02	0.01
P131	J58	J22	1,453.22	12		130	-5.57	0.02	0	0
P133	J60	J21	428.8	12		130	-37.1	0.11	0	0.01
P135	J21	J20	1,604.30	12		130	-65.51	0.19	0.03	0.02
P137	J20	J19	561.79	12		130	97.27	0.28	0.02	0.03
P141	J20	J62	1,161.91	12		130	-193.61	0.55	0.14	0.12
P143	J62	J18	375.06	12		130	-216.61	0.61	0.06	0.15
P145	J18	J64	486.16	12		130	-233.97	0.66	0.08	0.17
P147	J58	J60	803	12		130	-116.39	0.33	0.04	0.05
P149	J60	J56	604.43	12		130	-107.07	0.3	0.02	0.04
P151	J56	J66	1,692.40	12		130	-165.82	0.47	0.15	0.09
P153	J66	J64	1,021.01	12		130	-199.34	0.57	0.13	0.13
P155	J66	J23	525.4	12		130	5.83	0.02	0	0
P161	J64	J70	445.7	12		130	132.64	0.38	0.03	0.06
P163	J70	J72	329.98	12		130	42.04	0.12	0	0.01
P165	J72	J26	1,651.26	12		130	16.87	0.05	0	0
P167	J24	J25	309.06	12		130	-99.21	0.28	0.01	0.04
P169	J25	J80	411.15	12		130	-114.49	0.32	0.02	0.05
P171	J70	J80	1,410.69	12		130	68.63	0.19	0.03	0.02
P173	J26	J74	619.75	12		130	-9.12	0.03	0	0
P175	J74	J76	598.96	12		130	-20.3	0.06	0	0
P177	J76	J78	677.06	12		130	-29.98	0.09	0	0
P179	J78	J80	1,259.60	12		130	72.05	0.2	0.02	0.02
P181	J64	J17	1,946.12	12		130	-579.56	1.64	1.8	0.92
P183	J17	J27	962.49	12		130	-632.18	1.79	1.04	1.08
P197	J34	J40	2,632.93	12		130	184.02	0.52	0.29	0.11
P213	J16	J34	2,141.15	12		130	319.06	0.91	0.65	0.31
P217	RES9010	J27	1,330.64	12		130	657.74	1.87	1.55	1.17
P219	RES9008	J46	665.41	12		100	425.87	1.21	0.56	0.85
P221	J30	J22	2,589.55	12		130	-41.58	0.12	0.02	0.01
P223	J22	J19	2,367.35	12		130	-73.07	0.21	0.05	0.02
P225	J23	J24	2,298.86	12		130	-75.88	0.22	0.05	0.02

P233	J78	J82	4,057.96	12	100	-104.95	0.3	0.26	0.06
P235	J82	J54	1,206.50	12	100	-106.64	0.3	0.08	0.07
P237	J82	J32	13,724.69	12	100	-94.45	0.27	0.72	0.05
P245	J16	RES9022	563.36	12	130	-777.4	2.21	0.9	1.59
P53	J1	J2	2,835.47	12	130	52.19	0.15	0.03	0.01
P55	J2	J3	2,071.12	12	130	19.37	0.05	0	0
P57	J3	J46	704.66	12	130	-8.92	0.03	0	0
P59	J46	J44	515.4	12	130	352.41	1	0.19	0.37
P61	J44	J42	958.43	12	130	138.4	0.39	0.06	0.07
P63	J44	J5	574.96	12	130	199.1	0.56	0.07	0.13
P67	J40	J42	1,035.34	12	130	-79.92	0.23	0.02	0.02
P69	J42	J9	1,285.03	12	130	157.9	0.45	0.11	0.08
P71	J9	J48	1,871.25	12	130	119.18	0.34	0.09	0.05
P73	J40	J11	559.91	12	130	211.65	0.6	0.08	0.14
P75	J10	J48	1,660.98	12	130	56.48	0.16	0.02	0.01
P77	J11	J10	981.29	12	130	149.99	0.43	0.07	0.08
P79	J5	J6	1,278.10	12	130	176.5	0.5	0.13	0.1
P81	J6	J52	1,314.19	12	130	143.92	0.41	0.09	0.07
P83	J52	J8	376.91	12	130	41.84	0.12	0	0.01
P85	J8	J50	455.92	12	130	30.21	0.09	0	0
P87	J48	J50	980.29	12	130	105.85	0.3	0.04	0.04
P89	J52	J7	903.39	12	130	78.38	0.22	0.02	0.02
P91	J7	J54	714.38	12	130	71.53	0.2	0.01	0.02
P93	J50	J54	818.7	12	130	101.06	0.29	0.03	0.04
P99	J1	J32	995.3	12	130	-159.15	0.45	0.08	0.08

**Phases 1,2 and 3 Potable Water Maximum Day Demand Pipes**

ID	From Node	To Node	Diameter		Roughness	Flow (gpm)	Velocity	Headloss (ft)	HL/1000 (ft/k-
			Length (ft)	(in)			(ft/s)		ft)
P101	J32	J16	1,027.54	12	130	-710.02	2.01	1.38	1.34
P105	J34	J36	958.33	12	130	77.34	0.22	0.02	0.02
P107	J36	J14	730.64	12	130	-169.34	0.48	0.07	0.09
P109	J14	J15	711.86	12	130	-225.39	0.64	0.11	0.16
P111	J15	J32	676.29	12	130	-282.68	0.8	0.17	0.24
P113	J1	J4	1,145.92	12	130	171.92	0.49	0.11	0.1
P115	J4	J38	1,133.89	12	130	94.65	0.27	0.04	0.03
P117	J38	J36	723.34	12	130	199.5	0.57	0.09	0.13
P119	J36	J13	957.7	12	130	402.45	1.14	0.45	0.47
P121	J13	J12	716.15	12	130	330.2	0.94	0.23	0.33
P123	J12	J42	937.53	12	130	257.03	0.73	0.19	0.2
P125	J38	J28	1,127.74	12	130	-165.78	0.47	0.1	0.09
P127	J28	J46	953.64	12	130	-240.48	0.68	0.17	0.18
P129	J30	J58	1,932.13	12	130	-96.73	0.27	0.06	0.03
P131	J58	J22	1,453.22	12	130	-10.14	0.03	0	0
P133	J60	J21	428.8	12	130	-71.45	0.2	0.01	0.02
P135	J21	J20	1,604.30	12	130	-128.27	0.36	0.09	0.06
P137	J20	J19	561.79	12	130	193.5	0.55	0.07	0.12
P141	J20	J62	1,161.91	12	130	-383.42	1.09	0.5	0.43
P143	J62	J18	375.06	12	130	-429.41	1.22	0.2	0.53
P145	J18	J64	486.16	12	130	-464.13	1.32	0.3	0.61
P147	J58	J60	803	12	130	-233.82	0.66	0.14	0.17
P149	J60	J56	604.43	12	130	-217.95	0.62	0.09	0.15
P151	J56	J66	1,692.40	12	130	-335.44	0.95	0.57	0.34
P153	J66	J64	1,021.01	12	130	-381.93	1.08	0.44	0.43
P155	J66	J23	525.4	12	130	-8.89	0.03	0	0
P161	J64	J70	445.7	12	130	148.02	0.42	0.03	0.07
P163	J70	J72	329.98	12	130	3.18	0.01	0	0
P165	J72	J26	1,651.26	12	130	-47.16	0.13	0.01	0.01
P167	J24	J25	309.06	12	130	-218.96	0.62	0.05	0.15
P169	J25	J80	411.15	12	130	-249.54	0.71	0.08	0.19
P171	J70	J80	1,410.69	12	130	100.9	0.29	0.05	0.04
P173	J26	J74	619.75	12	130	-99.14	0.28	0.02	0.04
P175	J74	J76	598.96	12	130	-121.49	0.34	0.03	0.05
P177	J76	J78	677.06	12	130	-140.86	0.4	0.05	0.07
P179	J78	J80	1,259.60	12	130	201.01	0.57	0.16	0.13
P181	J64	J17	1,946.12	12	130	-1,021.30	2.9	5.13	2.64
P183	J17	J27	962.49	12	130	-1,126.55	3.2	3.04	3.16
P197	J34	J40	2,632.93	12	130	363	1.03	1.02	0.39
P213	J16	J34	2,141.15	12	130	535.76	1.52	1.71	0.8
P217	RES9010	J27	1,330.64	12	130	1,177.66	3.34	4.57	3.43
P219	RES9008	J46	665.41	12	100	1,246.55	3.54	4.12	6.2
P221	J30	J22	2,589.55	12	130	-83.1	0.24	0.07	0.03
P223	J22	J19	2,367.35	12	130	-145.1	0.41	0.17	0.07
P225	J23	J24	2,298.86	12	130	-172.3	0.49	0.22	0.1

P233	J78	J82	4,057.96	12	100	-347.72	0.99	2.36	0.58
P235	J82	J54	1,206.50	12	100	-329.69	0.94	0.64	0.53
P237	J82	J32	13,724.69	12	100	-210.31	0.6	3.15	0.23
P245	J16	RES9022	563.36	12	100	-1,297.80	3.68	3.76	6.68
P53	J1	J2	2,835.47	12	130	-27.58	0.08	0.01	0
P55	J2	J3	2,071.12	12	130	-93.22	0.26	0.06	0.03
P57	J3	J46	704.66	12	130	-149.8	0.42	0.05	0.08
P59	J46	J44	515.4	12	130	823.98	2.34	0.91	1.77
P61	J44	J42	958.43	12	130	340.31	0.97	0.33	0.34
P63	J44	J5	574.96	12	130	453.85	1.29	0.34	0.59
P67	J40	J42	1,035.34	12	130	-193.62	0.55	0.13	0.12
P69	J42	J9	1,285.03	12	130	347.81	0.99	0.46	0.36
P71	J9	J48	1,871.25	12	130	270.36	0.77	0.42	0.22
P73	J40	J11	559.91	12	130	452.04	1.28	0.33	0.58
P75	J10	J48	1,660.98	12	130	141.72	0.4	0.11	0.07
P77	J11	J10	981.29	12	130	328.74	0.93	0.32	0.32
P79	J5	J6	1,278.10	12	130	408.66	1.16	0.62	0.48
P81	J6	J52	1,314.19	12	130	343.49	0.97	0.46	0.35
P83	J52	J8	376.91	12	130	91.94	0.26	0.01	0.03
P85	J8	J50	455.92	12	130	68.69	0.19	0.01	0.02
P87	J48	J50	980.29	12	130	272.45	0.77	0.22	0.23
P89	J52	J7	903.39	12	130	204.15	0.58	0.12	0.13
P91	J7	J54	714.38	12	130	190.45	0.54	0.08	0.12
P93	J50	J54	818.7	12	130	271.15	0.77	0.19	0.23
P99	J1	J32	995.3	12	130	-182.38	0.52	0.11	0.11

**Phase 1 Nonpotable Fire Flow Demand Junctions**

ID	Static Demand	Static Pressure		Fire-Flow	Residual	Available Flow at Hydrant	Available Flow
	(gpm)	(psi)	Static Head (ft)	Demand (gpm)	Pressure (psi)	(gpm)	Pressure (psi)
J27	24.09	66.33	346.07	3,000.00	29.83	3,466.55	20
J17	56.51	68.49	346.07	3,000.00	40.21	4,165.31	20
J30	87.7	78.32	345.74	3,000.00	51.72	4,874.30	20
J50	40.12	86.65	345.98	3,000.00	53.42	4,535.92	20
J7	8.13	86.65	345.98	3,000.00	54.44	4,585.39	20
J19	25.62	74.88	345.81	3,000.00	54.55	5,485.37	20
J20	33.11	73.59	345.83	3,000.00	55.56	5,851.82	20
J22	27.39	78.76	345.76	3,000.00	56.26	5,366.77	20
J62	24.61	72.78	345.97	3,000.00	57.34	6,370.02	20
J74	12	72.88	346.2	3,000.00	57.51	6,290.54	20
J18	18.61	72.37	346.03	3,000.00	58.38	6,750.52	20
J26	28.05	75.07	346.24	3,000.00	60.3	6,608.29	20
J76	9.13	75.9	346.16	3,000.00	60.42	6,479.36	20
J58	78.68	82.22	345.76	3,000.00	60.83	5,786.88	20
J54	70.14	87.52	345.98	3,000.00	61.34	5,309.75	20
J25	16.42	75.88	346.12	3,000.00	62.9	7,272.53	20
J24	25.03	76.74	346.1	3,000.00	63.06	7,098.49	20
J60	29.73	81.81	345.8	3,000.00	63.33	6,273.48	20
J82	90.63	87.09	345.99	3,000.00	63.36	5,636.31	20
J78	3.14	78.48	346.12	3,000.00	63.41	6,790.63	20
J66	30.08	76.7	346	3,000.00	63.5	7,369.04	20
J21	30.52	83.11	345.8	3,000.00	63.72	6,144.96	20
J56	63.37	82.25	345.83	3,000.00	64.29	6,433.66	20
J64	14.81	76.75	346.12	3,000.00	65.61	8,233.76	20
J23	87.67	80.16	346.01	3,000.00	65.91	7,276.91	20
J72	27	76.01	346.41	3,000.00	66.02	8,599.31	20
J80	28.12	78.93	346.15	3,000.00	67.18	8,042.12	20
J70	23.6	76.89	346.46	3,000.00	69.02	10,257.61	20

**Phases 1 and 2 Nonpotable Fire Flow Demand Junctions**

ID	Static Demand (gpm)	Static Pressure (psi)	Static Head (ft)	Fire-Flow Demand		Available Flow at Hydrant		Available Flow Pressure (psi)
				(gpm)	Residual Pressure (psi)	(gpm)		
J6	36.01	87.5	342.95	3,000.00	20.86	3,059.06	20	
J32	3.97	92.33	343.1	3,000.00	26.65	3,180.17	20	
J27	24.73	65.98	345.28	3,000.00	28.98	3,427.91	20	
J1	4.45	94.92	343.07	3,000.00	30.45	3,283.96	20	
J11	50.44	83.18	342.96	3,000.00	34.68	3,580.68	20	
J2	24.74	94.89	342.99	3,000.00	35.26	3,463.59	20	
J5	19.91	91.84	342.95	3,000.00	36.17	3,521.40	20	
J9	38.49	83.62	342.99	3,000.00	36.49	3,647.39	20	
J10	82.33	84.48	342.97	3,000.00	36.73	3,691.85	20	
J3	24.15	92.28	342.97	3,000.00	37.78	3,584.00	20	
J40	22.58	87.08	342.96	3,000.00	38.73	3,691.61	20	
J17	46.35	68.15	345.28	3,000.00	39.36	4,105.42	20	
J46	4.02	91.84	342.96	3,000.00	39.48	3,640.84	20	
J44	11.68	91.84	342.96	3,000.00	41.17	3,724.71	20	
J42	16.21	89.24	342.96	3,000.00	42.24	3,824.42	20	
J48	67.78	84.96	343.07	3,000.00	42.77	3,989.33	20	
J50	32.9	85.52	343.36	3,000.00	49.36	4,375.55	20	
J7	6.67	85.64	343.66	3,000.00	49.63	4,337.16	20	
J30	71.93	77.99	344.99	3,000.00	51.12	4,822.31	20	
J19	21.01	74.55	345.04	3,000.00	53.84	5,422.95	20	
J20	27.16	73.25	345.06	3,000.00	54.82	5,776.83	20	
J74	9.85	72.34	344.96	3,000.00	55.43	6,049.82	20	
J22	22.47	78.43	345	3,000.00	55.61	5,314.81	20	
J62	20.18	72.44	345.19	3,000.00	56.51	6,272.40	20	
J54	57.53	86.51	343.66	3,000.00	56.52	4,990.58	20	
J18	15.27	72.03	345.24	3,000.00	57.51	6,637.54	20	
J76	9.37	75.32	344.83	3,000.00	58.11	6,213.63	20	
J26	23	74.58	345.11	3,000.00	58.44	6,383.34	20	
J82	93.03	86.14	343.79	3,000.00	58.72	5,295.69	20	
J58	64.53	81.89	345	3,000.00	60.18	5,723.27	20	
J78	2.58	77.86	344.68	3,000.00	60.82	6,475.84	20	
J25	13.47	75.44	345.11	3,000.00	61.38	7,060.65	20	
J24	20.53	76.31	345.11	3,000.00	61.62	6,907.75	20	
J66	24.67	76.32	345.13	3,000.00	62.54	7,234.65	20	
J60	24.39	81.47	345.03	3,000.00	62.61	6,203.77	20	
J21	25.04	82.77	345.03	3,000.00	63	6,078.54	20	
J56	51.97	81.91	345.04	3,000.00	63.53	6,351.57	20	
J64	12.15	76.4	345.31	3,000.00	64.66	8,075.29	20	
J72	22.14	75.64	345.58	3,000.00	64.78	8,372.53	20	
J23	71.9	79.78	345.11	3,000.00	64.87	7,134.74	20	
J80	23.07	78.47	345.11	3,000.00	65.54	7,780.40	20	
J70	19.36	76.56	345.68	3,000.00	68.01	10,003.40	20	



**Phases 1,2 and 3 Nonpotable Fire Flow Demand Junctions**

ID	Static Demand (gpm)	Static Pressure (psi)	Static Head (ft)	Fire-Flow Demand		Available Flow at Hydrant		Available Flow Pressure (psi)
				(gpm)	Residual Pressure (psi)	(gpm)		
J27	25.32	65.3	343.71	3,000.00	27.22	3,347.82	20	
J11	53.78	81.29	338.61	3,000.00	36.69	3,743.57	20	
J9	33.78	81.75	338.67	3,000.00	37.34	3,749.24	20	
J10	81.58	82.6	338.63	3,000.00	37.55	3,795.30	20	
J17	45.91	67.47	343.71	3,000.00	37.60	4,002.34	20	
J16	22.69	88.21	338.59	3,000.00	41.32	3,841.36	20	
J12	31.91	86.48	338.60	3,000.00	41.43	3,892.85	20	
J14	24.45	87.35	338.59	3,000.00	41.65	3,880.53	20	
J40	45.62	85.19	338.61	3,000.00	41.68	3,950.57	20	
J48	60.9	83.1	338.79	3,000.00	42.06	4,037.51	20	
J2	28.63	92.98	338.59	3,000.00	43.01	3,846.98	20	
J34	41.62	87.78	338.59	3,000.00	43.08	3,972.15	20	
J13	31.52	88.65	338.59	3,000.00	43.31	3,955.21	20	
J3	24.68	90.38	338.60	3,000.00	43.65	3,929.45	20	
J6	28.42	85.75	338.91	3,000.00	43.85	4,046.76	20	
J28	32.58	90.38	338.59	3,000.00	44.73	4,000.67	20	
J8	10.14	82.83	339.17	3,000.00	44.85	4,182.99	20	
J36	19.08	88.65	338.59	3,000.00	44.88	4,040.67	20	
J42	24.39	87.36	338.62	3,000.00	44.95	4,083.10	20	
J38	26.58	89.51	338.59	3,000.00	44.99	4,032.57	20	
J15	24.99	90.81	338.59	3,000.00	45.05	4,001.37	20	
J32	15.12	90.38	338.59	3,000.00	45.99	4,059.88	20	
J46	14.08	89.95	338.60	3,000.00	46.15	4,080.46	20	
J4	33.7	92.98	338.59	3,000.00	46.38	4,037.68	20	
J50	30.53	83.7	339.17	3,000.00	46.44	4,299.11	20	
J7	5.98	83.79	339.38	3,000.00	46.80	4,289.12	20	
J52	20.67	84.57	339.17	3,000.00	46.85	4,287.55	20	
J5	19.71	90	338.71	3,000.00	47.15	4,144.28	20	
J44	13.01	89.97	338.63	3,000.00	47.46	4,163.93	20	
J1	16.59	92.98	338.59	3,000.00	47.58	4,092.99	20	
J30	78.44	77.27	343.34	3,000.00	49.27	4,712.20	20	
J54	57.54	84.73	339.55	3,000.00	50.55	4,623.49	20	
J19	21.11	73.84	343.40	3,000.00	52.04	5,271.98	20	
J74	9.75	71.39	342.77	3,000.00	52.58	5,746.04	20	
J20	26.9	72.54	343.42	3,000.00	53.02	5,604.78	20	
J82	95.23	84.47	339.95	3,000.00	53.22	4,924.60	20	
J22	22.62	77.71	343.35	3,000.00	53.79	5,177.85	20	
J62	20.06	71.75	343.59	3,000.00	54.73	6,074.23	20	
J76	9.59	74.3	342.47	3,000.00	55.03	5,885.84	20	
J18	15.14	71.34	343.65	3,000.00	55.74	6,417.90	20	
J26	22.67	73.7	343.09	3,000.00	55.81	6,094.29	20	
J78	2.55	76.75	342.14	3,000.00	57.47	6,102.10	20	
J58	64.22	81.18	343.35	3,000.00	58.36	5,578.29	20	
J25	13.34	74.64	343.26	3,000.00	59.05	6,762.90	20	
J24	20.35	75.51	343.27	3,000.00	59.35	6,634.43	20	
J66	24.15	75.59	343.44	3,000.00	60.68	6,990.94	20	
J60	24.24	80.76	343.37	3,000.00	60.80	6,035.31	20	
J21	24.78	82.06	343.38	3,000.00	61.19	5,920.02	20	
J56	51.25	81.19	343.38	3,000.00	61.71	6,178.30	20	
J72	21.96	74.98	344.04	3,000.00	62.83	8,049.90	20	
J64	11.87	75.72	343.75	3,000.00	62.91	7,794.25	20	
J23	71.28	79.03	343.38	3,000.00	62.94	6,906.01	20	
J80	22.84	77.67	343.25	3,000.00	63.12	7,431.25	20	
J70	19.17	75.94	344.25	3,000.00	66.4	9,628.19	20	

# **APPENDIX C**

## **Water Supply Alternatives for Consideration in the Environmental Impact Report**



## TECHNICAL MEMORANDUM

**TO:** Matthew Gerken, AICP, AECOM

**DATE:** October 24, 2017

**CC:** Jeff Goldman, AICP, AECOM  
Matt Machado, PE, Stanislaus County Public Works  
Keith Boggs, Stanislaus County  
Alex Bargmeyer, PE, E-PUR  
Kevin Berryhill, PE, Provost & Pritchard

**PREPARED BY:** John M. Lambie, PG, PE, E-PUR  
Dena Traina, PE, Provost & Pritchard

**PROJ. NO.** 0624-001-02

**SUBJECT: CROWS LANDING INDUSTRIAL BUSINESS PARK WATER SUPPLY ALTERNATIVES FOR CONSIDERATION IN THE ENVIRONMENTAL IMPACT REPORT**

---

### INTRODUCTION

Stanislaus County's planned Crows Landing Industrial Business Park (CLIBP) requires a water supply for both potable and non-potable water demands. The purpose of this document is to describe for AECOM updated concepts for water supply that consider the impacts and implications of California Senate Bill 1263. Under SB 1263, any new drinking water system seeking a permit from the State Water Resources Control Board's Division of Drinking Water (DDW) must conduct a meaningful dialogue with all existing systems within three miles of any portion of the respective water service areas to evaluate the feasibility of consolidation, annexation, or extension of water services. The CLIBP is within three miles of both the City of Patterson (Patterson) and Crows Landing Community Services District (the CSD) water systems. Preliminary discussions have been held by Stanislaus County (the County) with both systems' engineering and administrative staff to assess viable alternatives to extend their respective service areas to include the CLIBP.

An initial meeting between DDW and Stanislaus County Public Works on September 26, 2017 identified that if Stanislaus County applies for a drinking water supply permit that SB 1263 will require consideration of operating CLIBP's water supply under one or both existing system permits. DDW also indicated that for a new permit for the CLIBP they would impose both primary and secondary drinking water standards rather strictly. The pending Public Draft Environmental Impact Report (DEIR) will want to consider each of three preliminary alternatives that would comply with SB 1263.

The three water supply alternatives to be considered are:

Alternative A) extension of the Crows Landing Community Services District service area to the CLIBP to cooperatively supply water and system improvements under the existing drinking water supply permit,

## Technical Memorandum

---

Alternative B) the County performs all the steps necessary to obtain a new permit to provide drinking water to the CLIBP including the required evaluations with nearby systems, and

Alternative C) the City of Patterson's water service area is extended to include the CLIBP under its existing drinking water supply permit.

Since a preferred alternative has not yet been identified, the DEIR will want to consider the three alternatives identified and described herein co-equally. By doing so, when the Notice of Determination is filed, the EIR will have appropriately addressed the selected alternative. This memo describes the initial development of each Alternative and identifies their material features for consideration in the DEIR.

### **BACKGROUND ELEMENTS TO USE OF GROUNDWATER IN SUPPLY FOR THE CLIBP**

As for the water supply alternatives, earlier work in 2015 and 2016 to support the pending DEIR assessed that both potable and non-potable water supply for the CLIBP would need to come from a groundwater source since surface water is not reliable nor available in the region.<sup>1</sup> That earlier water supply assessment still holds.

The earlier work for the pending DEIR evaluated the needed flow rates and yearly quantities of potable water supply from water producing zones beneath a region wide thick clay layer, the Corcoran Clay. The same type of evaluation was done for non-potable water supply to the CLIBP and it was felt that water producing zones above the Corcoran Clay might be best suited to those needs due to water quality and reliability concerns (the shallow aquifer zones at the south end of the airstrip have been known to dewater in dry years). This strategy of supplies was assessed against Stanislaus County's Well Ordinance for sustainability and against CEQA Guidelines.<sup>2</sup> E-PUR's Technical Memorandum (TM) of May 17, 2017 documents the field findings that a likely sufficient quantity and rate of groundwater production is available at the north end of the airstrip beneath the Corcoran Clay but with concentrations of sulfate that would necessitate either blending or treatment in order to produce potable water. Thus, the configuration and conceptual engineering design of potable water supply to the CLIBP from groundwater zones beneath the CLIBP deserve to be revisited to limit the higher costs associated with treating groundwater for potable supply. Non-potable supply can be reconsidered at this same time. This memorandum is intended to outline the changes in concept for water supply under consideration for each of Alternatives A, B and C.

There are several common considerations for each of the three alternatives as well as overall project water supply provisions. First and foremost, our understanding is that the estimated annual water demand for potable and non-potable supplies for the CLIBP have not changed neither by planned buildout phase nor in total. Second, each water supply alternative must develop the same new supply capacity since neither Alternative A or C anticipate being supplied a net quantity of raw or finished water to meet CLIBP needs from outside the CLIBP by the CSD or Patterson, respectively. As a result of these

---

<sup>1</sup> VVH, 2015, "Crows Landing Industrial Business Park, Water Supply (Potable and Non-Potable) Infrastructure and Facilities Study, February 27, 2015

<sup>2</sup> JJA, 2016, "Groundwater Resources Impact Assessment, Crows Landing Industrial Park, Stanislaus County, California," Draft August 19.

---

considerations the projected annualized rates of groundwater production by phase have not been changed from the earlier estimates.

The vertical well-screen intervals for the supply of potable and non-potable water have changed as have the number and the lateral locations of wells. Each of the three alternatives envisions using two or more wells in each of the phases. Based on E-PUR's earlier TM analysis of the aquifer zones below the Corcoran Clay and information gleaned from both the field and the literature regarding the aquifer units above the Corcoran Clay, each well location can be anticipated to be capable of producing 1,000 gallons per minute or more. Potable and non-potable water will be derived from the same wells. The groundwater pumping exclusion zone associated with the former NASA Crows Landing Flight Facility operations has been taken into consideration and the lateral locations of wells set outside that area as depicted on Figure 5 of E-PUR's TM regarding the CLIBP groundwater supply field evaluations dated May 17, 2017.

Non-potable water may or may not be split out after water is piped to a Water Plant at the southeast corner of the CLIBP at the juncture of Fink and Bell Roads. This Water Plant is common to all three alternatives (see Figures A2 to A4 for example). A split of non-potable from potable water supplies would occur if either water treatment is required for potable water or there is a desire or need by the County for piping facilities to accept non-potable water from other prospective sources (e.g., use of highly treated reclaimed water). As a result, each alternative demonstrates a potable and non-potable water piping system. We note here that the location and phasing of the overall piping of potable and non-potable water remains largely unchanged from the earlier work on water supply assessments for the CLIBP (VVH, 2015). We note that some modifications have been made to the conceptual location of potable and non-potable water tanks shown on the figures; however, in concept the size of the needed storage tanks by capacity and purpose remains the same from those same earlier evaluations.

The addition of two or more wells to each of the two initial buildout phases addresses several issues around the security and surety of water supply for the CLIBP. Having at least two wells in Phase 1 provides added reliability should a well fail or should water quality vary suddenly in a well. Then for each phase and the project overall, having two or more wells will enable both the design and the ultimate operation of a supply wellfield with more flexibility during operations to minimize or better control hydraulic drawdown. Utilizing more wells also has the added benefits of: reliability in supply should the shallow aquifer unit dewater in certain areas, decreased likelihood of drawing in water of lower quality from adjoining areas most notably from adjoining agricultural areas, and providing added flexibility to control aquifer drawdown if project related subsidence effects are believed to be occurring.

#### **ALTERNATIVE A – EXTENSION OF CROWS LANDING COMMUNITY SERVICES DISTRICT SERVICE AREA TO CLIBP**

Under Alternative A the County would combine its needs for a water supply at the CLIBP with the CSD's needs around water service to conform with changes to state laws on drinking water supply. There are two principal goals for combining the needs of the CSD and CLIBP to one water system:

- 1) produce the best quality water possible, and
- 2) produce that water at the lowest possible cost, both administratively and technically.

## Technical Memorandum

Based on water quality data collected to date within the CSD's water system and from groundwater test wells within the CLIBP area it appears that bringing together and blending the water sourced from each area can produce good quality drinking water. Blending the two water sources may eliminate the potential need for treatment. This large potential benefit results from the offsetting concentrations of chemicals of concern. For example, hexavalent chromium, Cr(VI), has been detected above 10 parts per billion (ppb) in the Crows Landing CSD water system at both of their groundwater supply wells. The CSD currently has a planning grant from the DDW to address Cr(VI). The concentrations of Cr(VI) detected in shallow and deep groundwater in the CLIBP area range from undetectable to a high of 6.6 ppb. Conversely, concentrations of sulfate in groundwater beneath the CLIBP have been detected above the "recommended" secondary drinking water standard of 250 parts per million (ppm) and sulfate concentrations in both groundwater wells at the CSD are below that lower threshold. Thus, a blending of water sources can lower concentrations of each of these troublesome water quality constituents and may eliminate the need for treatment. Importantly, groundwater sources within each area have concentrations of total dissolved solids (TDS) and nitrate below drinking water standards. As a result, blending the two water sources can produce a suitable supply of water for both quantity and quality with little to no treatment.

Administratively there are many state requirements for small water systems that can be more efficiently met by a consolidated single water system. With two independent systems, the CLIBP and Crows Landing CSD, would each need to have its own system operations and administration. With a single system arising from simple extension of the CSD's current service area there would be efficiency in operations and administration from the combined operation. Meters are now required for all service connections to a drinking water supply system. A consolidated system could readily obtain state grant funding for such meters and enable sufficient capital planning for these meters to be outfitted to existing customers of the Crows Landing CSD. The water system could also utilize a tiered rate structure for service connections to ease affordability for residential customers by charging a higher rate to industrial customers. A consolidated system could also provide reserve capital planning for system maintenance to avoid service disruptions.

The broad framework of a combined water supply system would likely consist of the following high-level elements:

- An interconnection of the current Crows Landing CSD area to the CLIBP area by way of a service corridor along Fink Road to enlarge the service area for the CSD water system shown on Figure A1.
- A raw water supply pipeline of 6-inches or more in diameter placed in a trench excavation 2-feet wide by 5-feet in depth along the north side of Fink Road as depicted in concept on Figure A2.
- Two or more source wells within the current Crows Landing CSD Service Area, such as the current Wells 4 and 5 if suitable (not depicted).
- Approximately four groundwater supply wells within the CLIBP to produce raw water for blending and to meet its planned water demands/needs in a phased manner consistent with the CLIBP development plan as depicted in concept on Figure A2;
- Source (raw) water blending within the CLIBP footprint in the southeast corner as depicted on Figures A2 and A3.

## Technical Memorandum

- Water supply piping to transmit potable water for both emergency and non-emergency water demands installed along the north side of Fink Road to Crows Landing is depicted in concept on Figure A3. This supply line would be a minimum of 12-inch-diameter pipe placed in a separate trench offset at least 10-feet from the raw water pipe depicted in Figure A2 in accordance with California drinking water system standards. The supply piping trench would likely be excavated 3-feet wide by 5-feet deep.
- Water supply piping to transmit raw water along the west side of Bell Road via an 18-inch diameter pipe installed in a trench excavated 3.5-feet wide by 5-feet deep (see Figure A2).
- Water supply piping for non-potable water depicted in concept on Figure A4 would be constructed in excavation trenches a minimum of 2 -feet wide by 5 -feet deep.
- Water supply piping for potable water depicted in concept on Figure A3 would be placed in excavation trenches a minimum of 2-feet wide by 5-feet deep offset at least 10-feet from raw and non-potable water pipes along parallel routes, in accordance with California drinking water system standards .
- Potable water supply piping, water storage tanks to the west and northwest toward the CLIBP developed areas in general accord with the earlier work by VVH and AECOM<sup>3</sup> regarding storage capacity needs for potable water and the layout of piping by development phases (depicted in Figure A3).
- The consolidated system for Crows Landing CSD and CLIBP may be a combined water system for both potable and non-potable water needs depending upon treatment needs but for the DEIR the non-potable needs should be evaluated against the depiction on Figure A4 that generally follows the layout and phasing for piping and storage done previously in AECOM/VVH, 2016.
- Specifics of water storage, pipe sizes, booster pumps, blending requirements within CLIBP as well as any modifications to distribution system piping and service connections may vary somewhat based on future detailed engineering design.
- Further specification of water storage, pipe sizes, booster pumps, and other details on the supply system within the CSD's current service area as wells as any modifications to distribution system piping and service connections may vary somewhat based on future detailed engineering design but these types of modifications appear to be outside the scope of the DEIR analysis needed for the CLIBP.

Providing for the water supply needs for both areas under the existing Crows Landing CSD permit to operate a drinking water system alleviates the need for some of the extensive evaluations that will be required of each area if they operate separate systems. The CLIBP would not need to obtain a new water system operating permit under SB 1263, and the Crows Landing CSD may not need to provide hexavalent chromium treatment to meet anticipated drinking water standards. LAFCO considerations would need to be met in extending the service area of Crows Landing CSD to encompass the CLIBP for water service.

---

<sup>3</sup> VVH, 2015 and AECOM/VVH, 2016, "Crows Landing Industrial Business Park, Water Supply (Potable and Non-Potable) Infrastructure and Facilities Study, February 27, 2015 and Updated September 27, 2016.

---

**ALTERNATIVE B DEVELOP A STAND ALONE CLIBP WATER SUPPLY SYSTEM**

Under Alternative B the County would provide a water supply at the CLIBP. Since a portion of the water supply will be for drinking water SB 1263 will apply directly and must be met. Those requirements are generally addressed in the development of this Alternative B general elements.

Based on water quality data collected to date from groundwater wells at and adjacent the CLIBP it appears possible that potable quality water can be produced without treatment. However, some treatment for sulfate may be required by DDW unless waiver of the “Recommended” secondary drinking water standards for both sulfate and total dissolved solids (TDS) can be obtained during permitting by DDW.<sup>4</sup> Concentrations of TDS for all wells in the region are above the “Recommended” secondary drinking water standard of 500 parts per million (ppm), and are at or just below the “Upper” secondary drinking water standard of 1,000 ppm. Similarly concentrations of sulfate in groundwater beneath the CLIBP in water producing zones range between 320 ppm and 600 ppm with an anticipated concentration of sulfate of around 380 ppm from a vertically integrated production well based upon the chemistry of water from an agricultural water supply well that draws from both shallow and deep aquifer units in the area of the planned wellfield. The “Recommended” secondary drinking water standard for sulfate is 250 ppm while the “Upper” secondary drinking water standard is 500 ppm. Hence it is likely that water produced at the CLIBP will be potable in regard to these two constituents. Regarding two other key constituents, Cr (VI) and nitrate, groundwater quality samples from both shallow and deep units beneath the CLIBP are below the primary drinking water standards.

Administratively there are many state requirements for permitting a new water system under SB 1263 since the CLIBP service area is within three miles of two existing water systems, Crows Landing CSD and City of Patterson. The primary mechanism for this administration is the requirement for the County to submit a “preliminary technical report” under the law. The particular contents of such a preliminary technical report under SB 1263 include:

- The name of each public water system within three miles
- A discussion of the feasibility of annexing, connecting or otherwise supplying water to the CLIBP via those existing systems
- Documentation of the consultation with adjacent public water systems about supplying water to the CLIBP
- Documentation of any information provided by adjacent water systems on the feasibility of annexing, connecting or otherwise supplying water to the CLIBP
- A discussion of all actions taken by the County to secure a supply from an existing water system
- A comparison of costs between a new system and cost of joining an existing system
- An analysis of supply resilience a 20-year projection inclusive of normal, single dry, or multiple dry water years
- Any information provided by the local agency formation commission (LAFCO) for consideration.

---

<sup>4</sup> The drinking water standard typically applied for secondary standards is or has been the “Upper” concentrations

---



## Technical Memorandum

---

Then there are the added requirements of establishing water quality standards that can be met and ways in which they are proposed to be met.

The broad framework of a CLIBP stand-alone water supply system would likely consist of the following high-level elements:

- A CLIBP service area that takes into account the two nearby existing systems depicted on Figure B1.
- Approximately four groundwater supply wells within the CLIBP to produce raw water as depicted in concept on Figure B2;
- Source (raw) water disinfection (and potentially treatment) at a Water Plant within the CLIBP footprint in the southeast corner as depicted on Figures B2 and B3.
- Water supply piping to transmit raw water along Bell Road via an 18-inch diameter pipe installed in a trench excavated 3-feet wide by 5-feet deep (see Figure B2).
- Water supply piping for non-potable water along Bell Road and Fink Roads in excavation trenches a minimum of 3-feet wide by 5-feet deep depicted in concept on Figure B4.
- Water supply piping for potable water along Bell Road and Fink Roads depicted in concept on Figure B3 installed in excavation trenches a minimum of 2 feet wide by 5 feet deep offset at least 10-feet from raw and non-potable water pipes along parallel routes in accordance with California drinking water system standards.
- Potable water supply piping, water storage tanks to the west and northwest toward the CLIBP developed areas in general accord with the earlier work by VVH and AECOM(AECOM/VVH, 2016) regarding storage capacity needs for potable water and the layout of piping by development phases (depicted in Figure B3).

The CLIBP would need to obtain a new water system operating permit under SB 1263. It should be noted in this description of Alternative B for the CLIBP water supply that it will be necessary for the County to develop a rate structure for its own system and compare it to a rate structure when the service area is combined with the CSD into and extended system or similarly with Patterson into an extended system. This will necessitate a request for information about both the CSD's and Patterson's current rate structure to develop a conceptual rate structure to satisfy those requirements of SB 1263. It is not necessary to develop anything definitive at this time for actual infrastructure, rate structures or staffing. This presentation is more conceptual in nature.

Lastly, LAFCO considerations may be pertinent to the DEIR and should be considered appropriately.

### **ALTERNATIVE C EXTENSION OF WATER SERVICES TO CLIBP FROM CITY OF PATTERSON**

Given the location of Patterson's supply sources and storage the viable alternative to be considered is an extension of services area. The source water for the extension would be produced by groundwater wells within the CLIBP footprint, and an intertie between the current and the extended area for supply redundancy.

Initial discussions with the Patterson on October 3, 2017 revealed that there is inadequate capacity to supply the CLIBP potable water and that extension of water service to CLIBP is not currently covered by Patterson's recently updated Water Master Plan nor the companion updates to Patterson's Capital

## Technical Memorandum

Improvement Plan. However, Patterson staff understood the need for the County to explore a prospective combination of potable water supply infrastructure under SB 1263 to ensure that viable alternatives were adequately addressed in the DEIR.

The overall concept for potable supply in Alternative C is for the County to drill and install a series of groundwater potable-water-supply wells at the CLIBP to provide the required capacity and to design and install an interconnecting water supply pipeline between the current Patterson service area and the CLIBP. This proposed intertie would provide desirable supply redundancy. The routing for an interconnecting pipeline was discussed and an appropriate route is to follow Ward Avenue south from Patterson to Marshall Road and then along Marshall Road to the east to where it intersects the northwest corner of the CLIBP. This overall extension of service area with an intertie corridor is depicted in Figure C1.

Based on groundwater quality data collected at CLIBP to date it appears possible that potable quality water can be generated without treatment. Both shallow and deep groundwater beneath the CLIBP will be used to optimize water quality. The broad details of Alternative C to be evaluated in the DEIR include bringing the groundwater sourced at the CLIBP to a local blending facility (and treatment, if necessary) at the juncture of Fink Road and Bell Road in the southeast corner of CLIBP. This location is suited to supplying the earliest phases of CLIBP. The intertie for water from Patterson would be brought to Phase 2 or 3 potable supply piping behind (i.e. after) any local water disinfection (and treatment, if necessary) or in order to not mix raw water at the CLIBP with finished water from Patterson.

Extension of the Patterson Water Service Area to the CLIBP would obviate the need to complete SB 1263 requirements since a new public drinking water system is not being created. The new source wells and configuration would require approval by DDW prior to their being commissioned under Patterson's current permit. Creation of an interconnecting pipeline (i.e., an intertie) between the two areas offers some potential benefits of supply redundancy in the event of service disruptions, maintenance needs, and other operational events within either area. It is assumed for the purposes of presentation herein that the drinking water system staffing and billing would be handled by Patterson. It is also assumed herein that a non-potable water system would be developed from raw water sources at the CLIBP and could be managed by Patterson as well.

The broad framework of a consolidated water supply system with Patterson would likely consist of the following high-level elements:

- An interconnection of the current Patterson area to the CLIBP area by way of a service corridor along Ward Avenue and Marshall Road to enlarge the service area for the water system (see Figure C1);
- Approximately four groundwater supply wells within the CLIBP to produce raw water to meet its planned water demands/needs in a phased manner consistent with the CLIBP development plan (see Figure C2);
- Source (raw) water production and chlorination/treatment within the CLIBP footprint;
- Water supply piping to transmit raw water along the west side of Bell Road via an 18-inch diameter pipe installed in a trench excavated 3.5-feet wide by 5-feet deep (see Figure C2).
- Water supply piping for non-potable water along Bell Road and Fink Roads in excavation trenches a minimum of 3-feet wide by 5-feet deep depicted in concept on Figure C4.

## Technical Memorandum

Page | 9

- 
- Water supply piping for potable water depicted in concept on Figure C3 in excavation trenches a minimum of 2 feet wide by 5 feet deep offset at least 10-feet from raw and non-potable water pipes along parallel routes in accordance with California drinking water system standards.
  - Water supply piping and infrastructure to transmit drinking water between the CLIBP and Patterson. It is anticipated that this piping will be located within the Marshall and Ward Avenue rights of way and will traverse under the Delta Mendota Canal twice, one on each roadway. The pipelines will need to be directionally drilled at least 25 feet below the Delta Mendota Canal. The remaining part of the alignment will be open cut trenched with a trench section of approximately 5-feet deep by 3.5-feet wide. Current working estimates are that the intertie pipe size is to be between 12-inches and 18-inches in diameter.
  - Potable water supply piping within the CLIBP would transmit water from the blending and disinfection/treatment facility to the west and northwest into developed areas with pressure supplied by local storage tanks and booster pumps (see Figure C3);
  - Water storage and booster pumps at CLIBP in two or three locations within the development will be needed for potable and non-potable water demands;
  - Water demand versus supply for the CLIBP fit within the CLIBP's Water Master Plan assessment of water availability, and as a result water sustainability remains the same for this drinking water system alternative, Alternative C; and,
  - Specifics of water storage, pipe sizes, booster pumps, blending requirements within CLIBP as well as any modifications to distribution system piping and service connections may vary somewhat based on future detailed engineering design.
  - Non-potable water configurations would most likely consist of sources and plumbing all within the CLIBP footprint as depicted in Figure C-4.

The DEIR's Project Specific Plan will describe and discuss the three water supply alternatives at this high level. Details of a prospective Alternative C integration with Patterson as well as evaluations of Alternative B in light of SB 1263 will be done in cooperation with Patterson, outside of the DEIR analysis to be performed by AECOM.

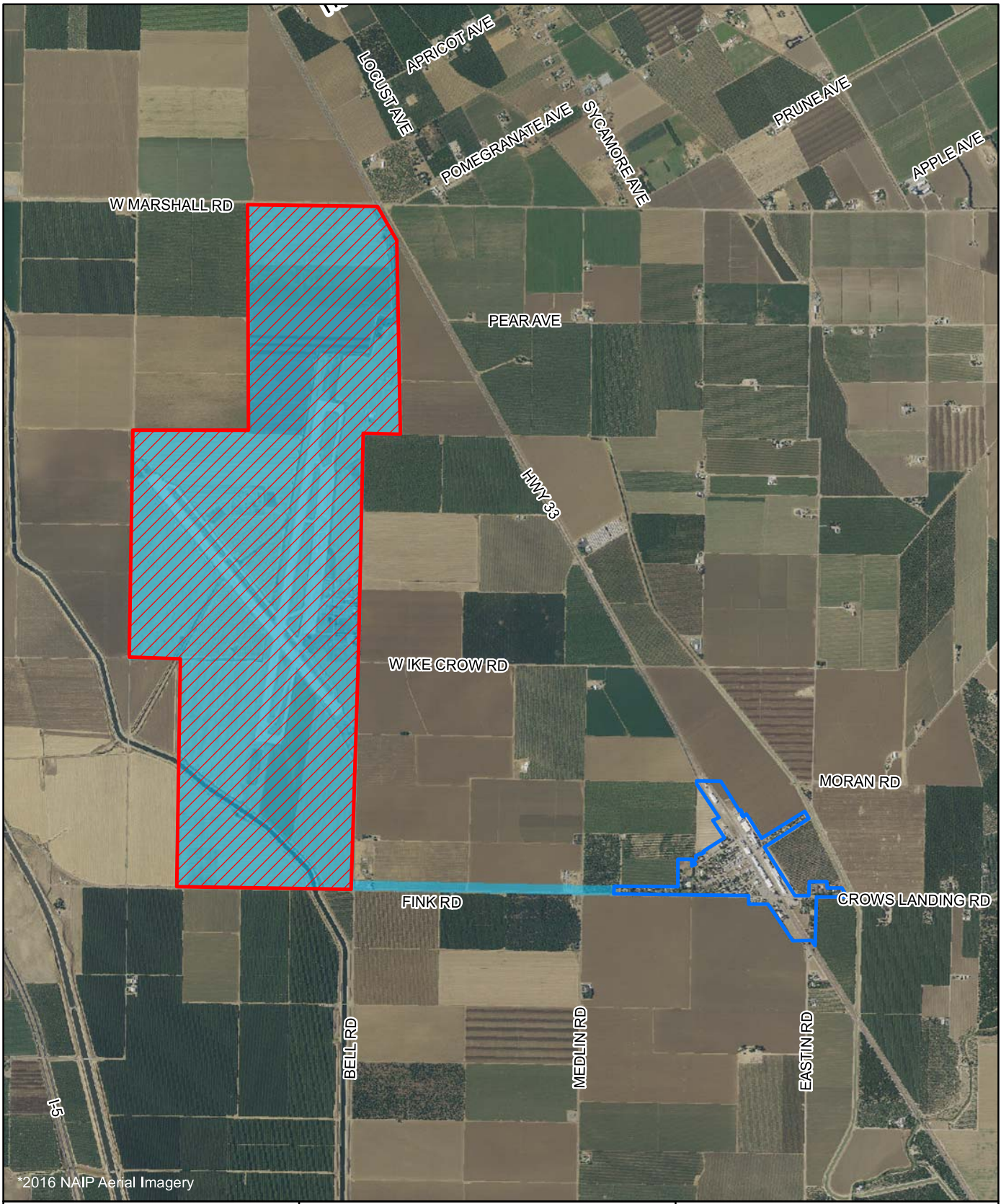
### Attachments:

Figures A1 to A4, B1 to B4, and C-1 to C-4 for each of the respective Alternatives A, B, and C

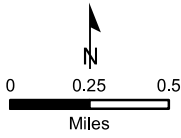
**Figure Depictions of a Conceptual Crows Landing CSD Water Supply  
for the Crows Landing Industrial Business Park**

**Alternative A**

---



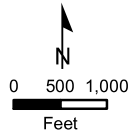
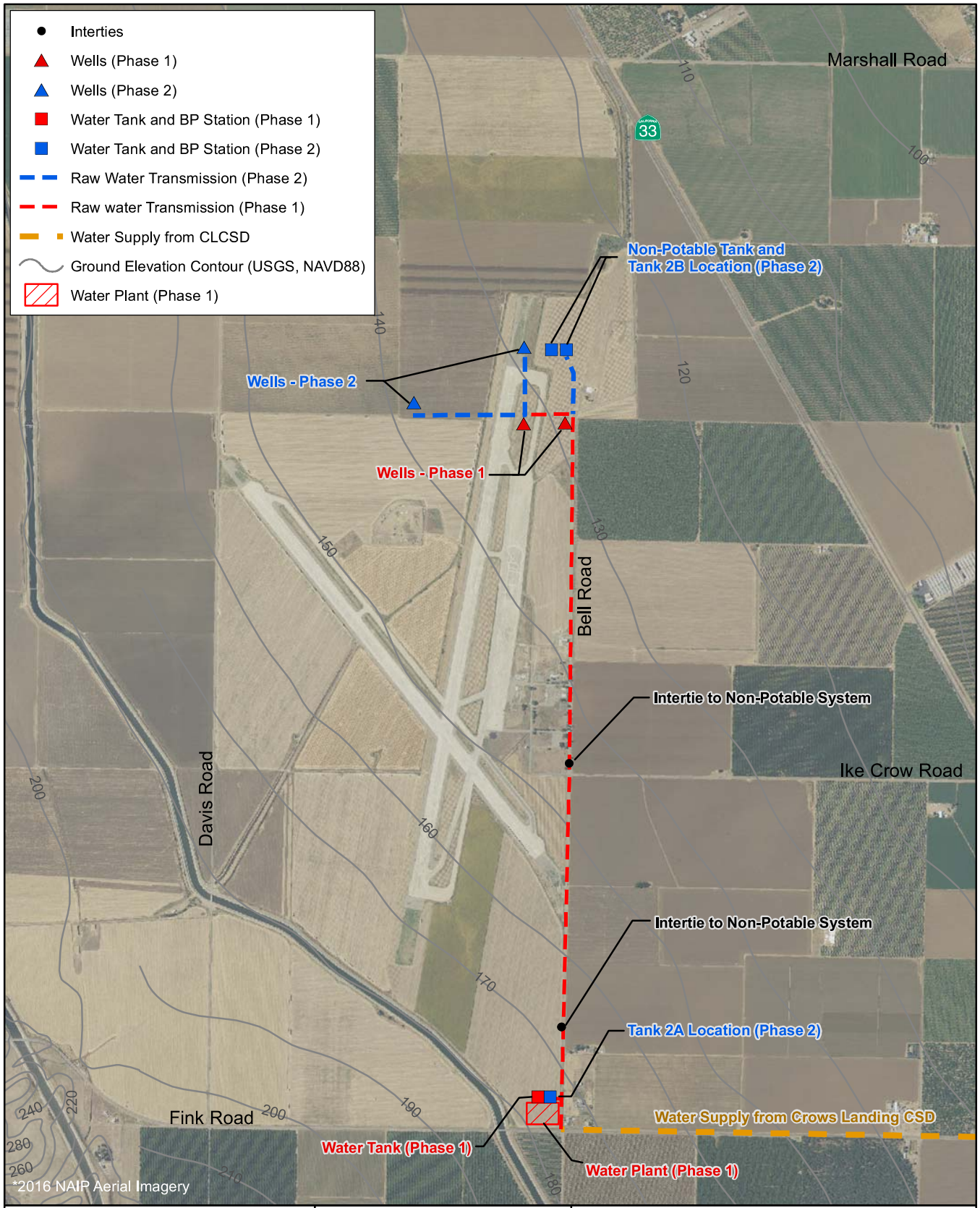
\*2016 NAIP Aerial Imagery



- Crows Landing CSD
- Crows Landing Industrial Business Park
- Proposed Extension Area to CLCSD



**Figure A1**  
**Crows Landing CSD and**  
**CLIBP Extension Service Area**



**Figure A2**  
**CLIBP Area Raw Water System for**  
**Crows Landing CSD Extension**  
**of Service**

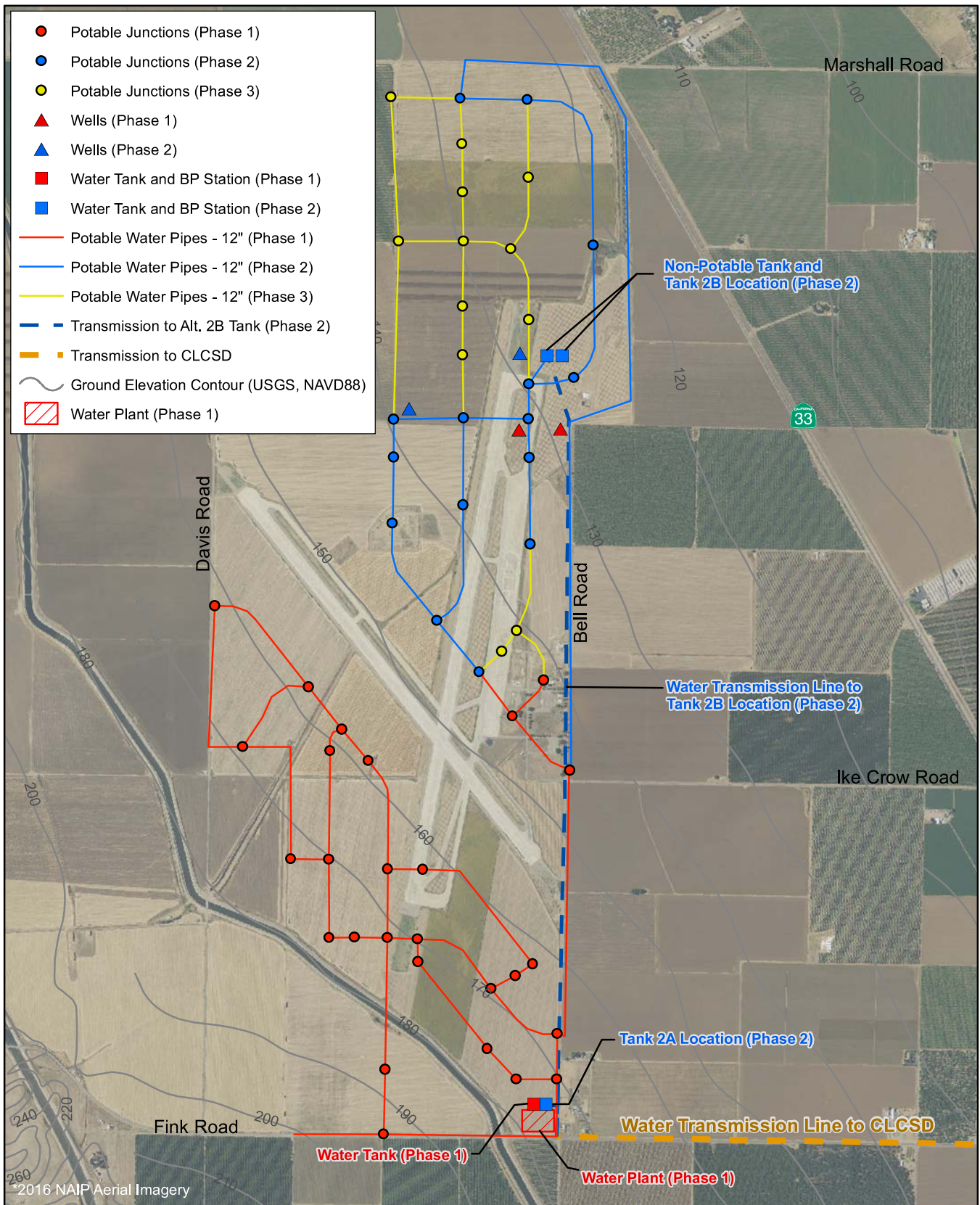
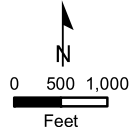
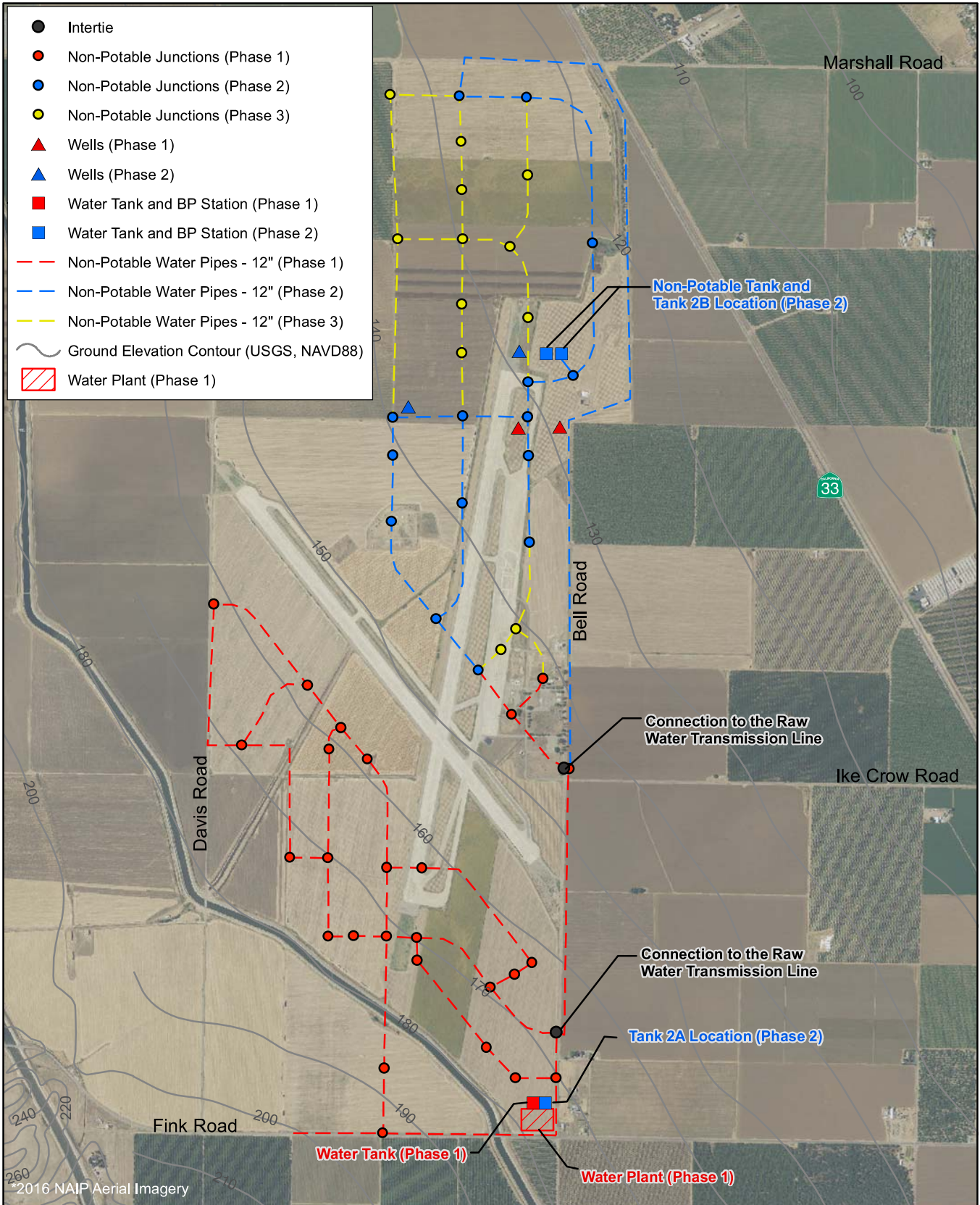


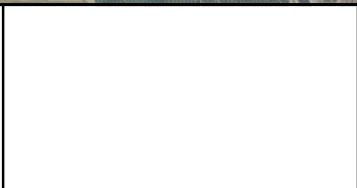
Figure A3  
CLIBP Area Potable Water System for  
Extension of Crows Landing CSD





EST. 1968  
**PROVOST & PRITCHARD**  
 CONSULTING GROUP  
 An Employee Owned Company

0 500 1,000  
 Feet



**Figure A4**  
 CLIBP Area Non-Potable Water System  
 for Extension of Crows Landing CSD

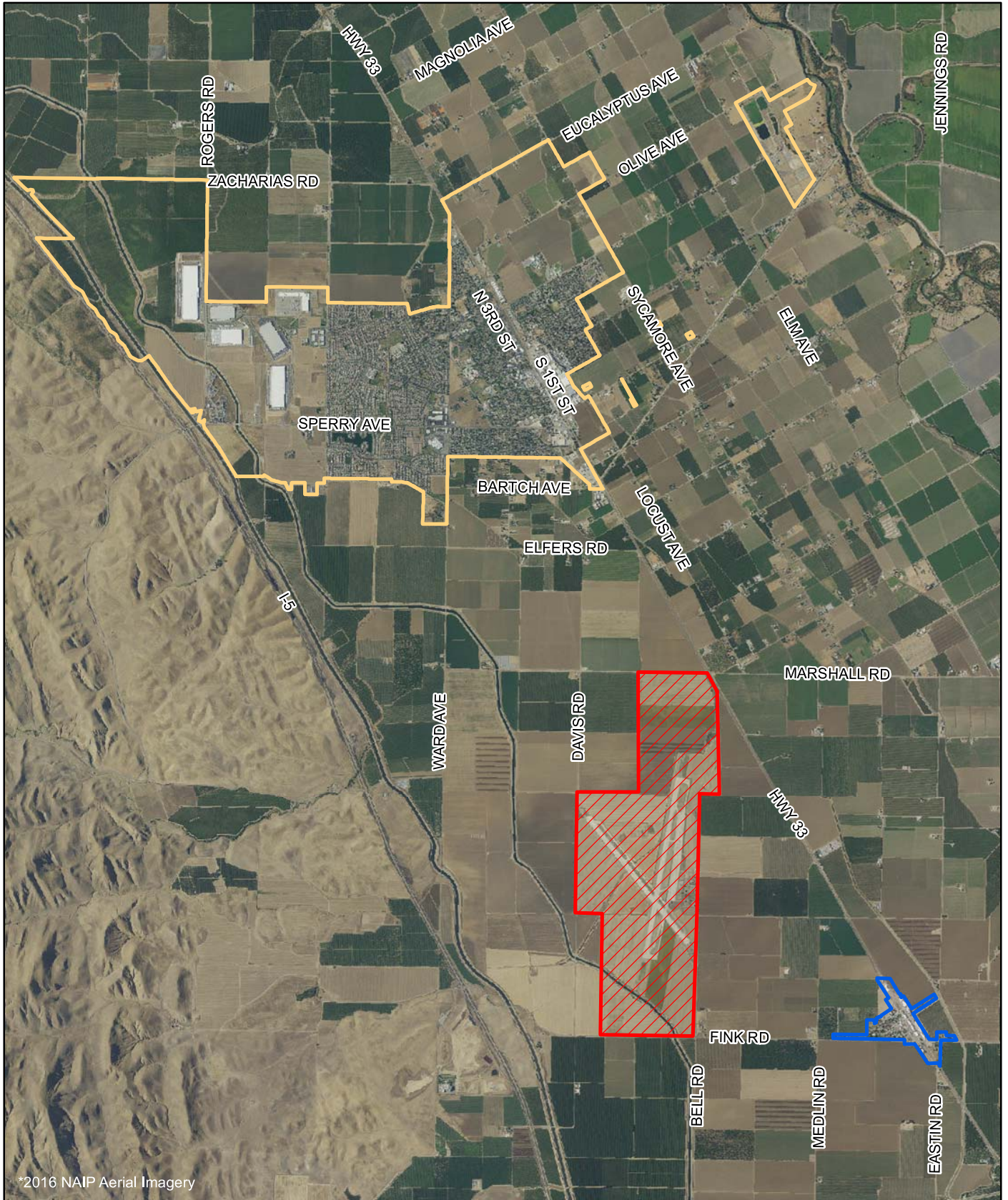
**E PUR**  
 Safe Water for All



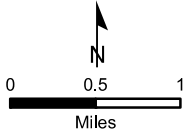
**Figure Depictions of a Conceptual Stand Alone Water Supply  
for the Crows Landing Industrial Business Park**

**Alternative B**

---



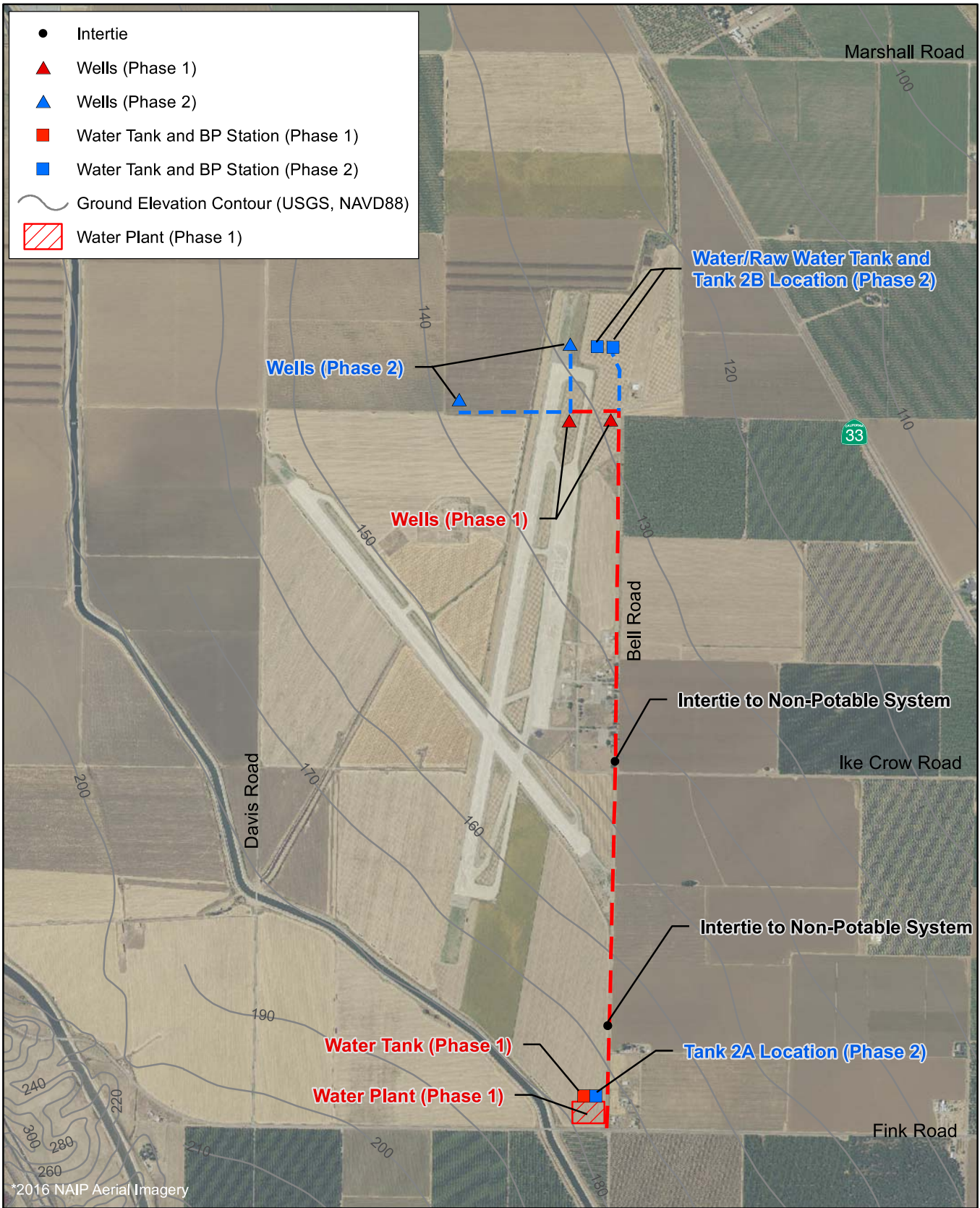
\*2016 NAIP Aerial Imagery



- Crows Landing CSD
- Crows Landing Industrial Business Park
- City of Patterson

**Figure B1**  
**CLIBP Location Map and**  
**Regional Public Water Systems**



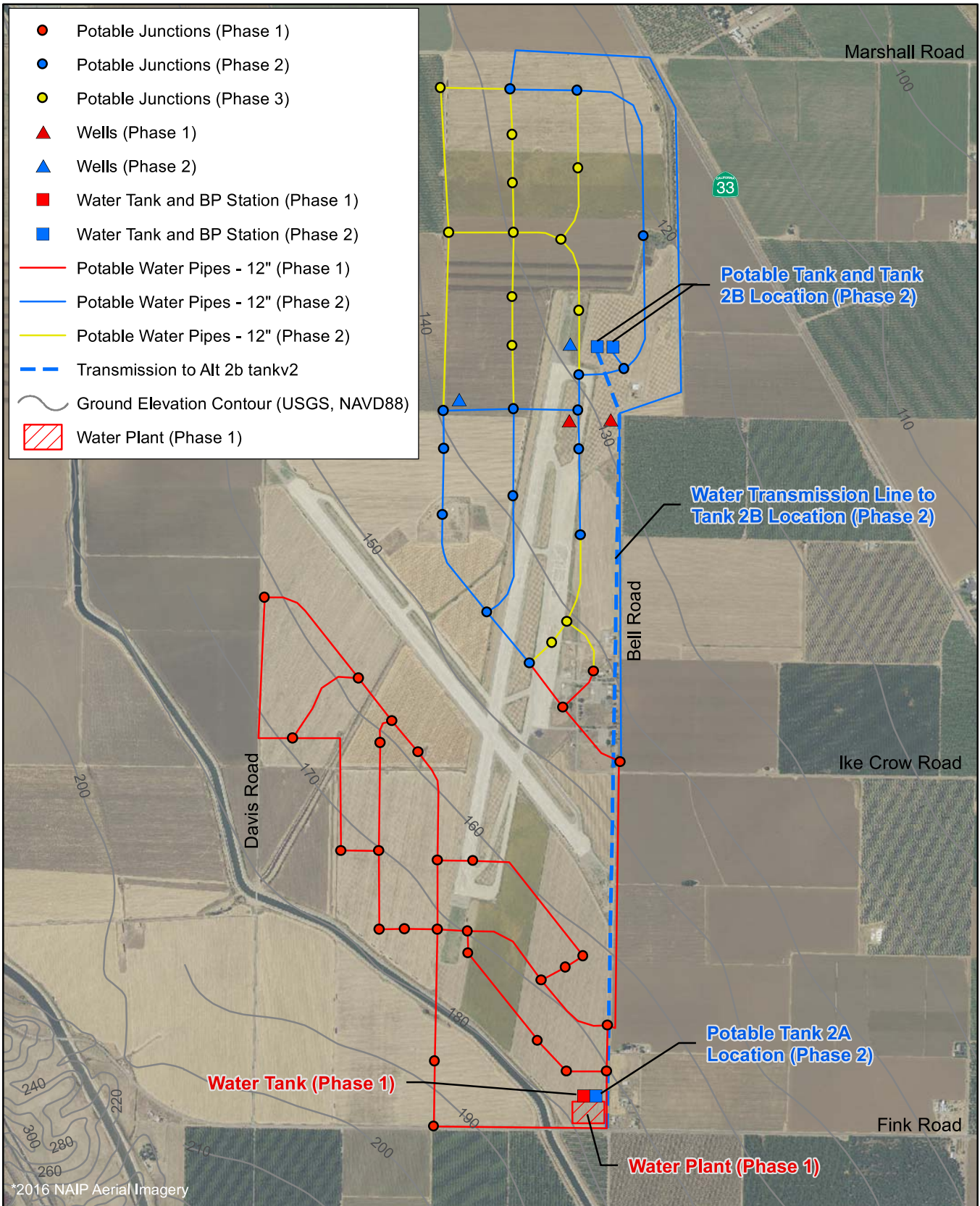


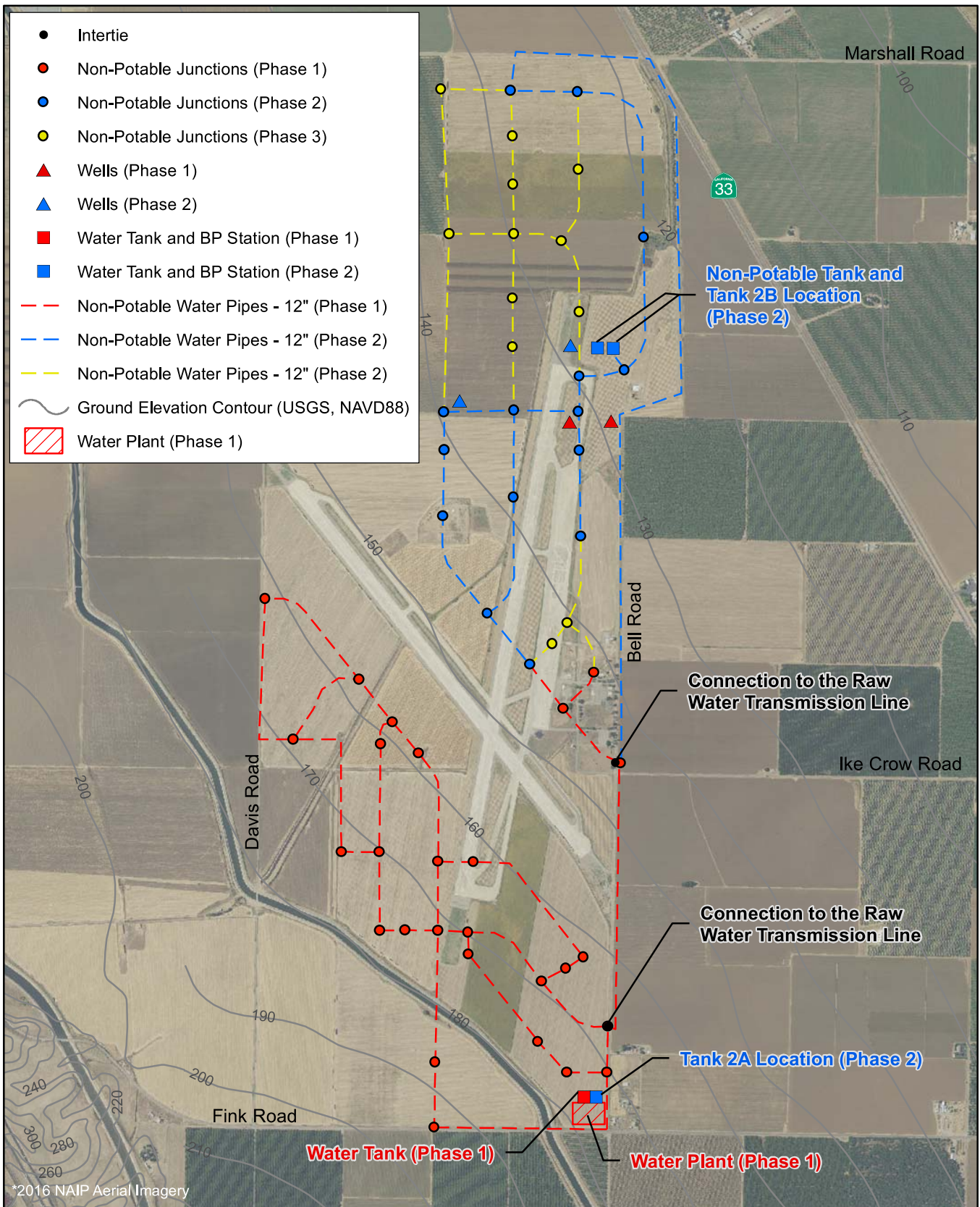
**Figure B2**  
**CLIBP Stand Alone Raw Water**  
**System Layout**

EST. 1968  
**PROVOST & PRITCHARD**  
 CONSULTING GROUP  
 An Employee Owned Company

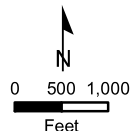
0 500 1,000  
 Feet







\*2016 NAIP Aerial Imagery

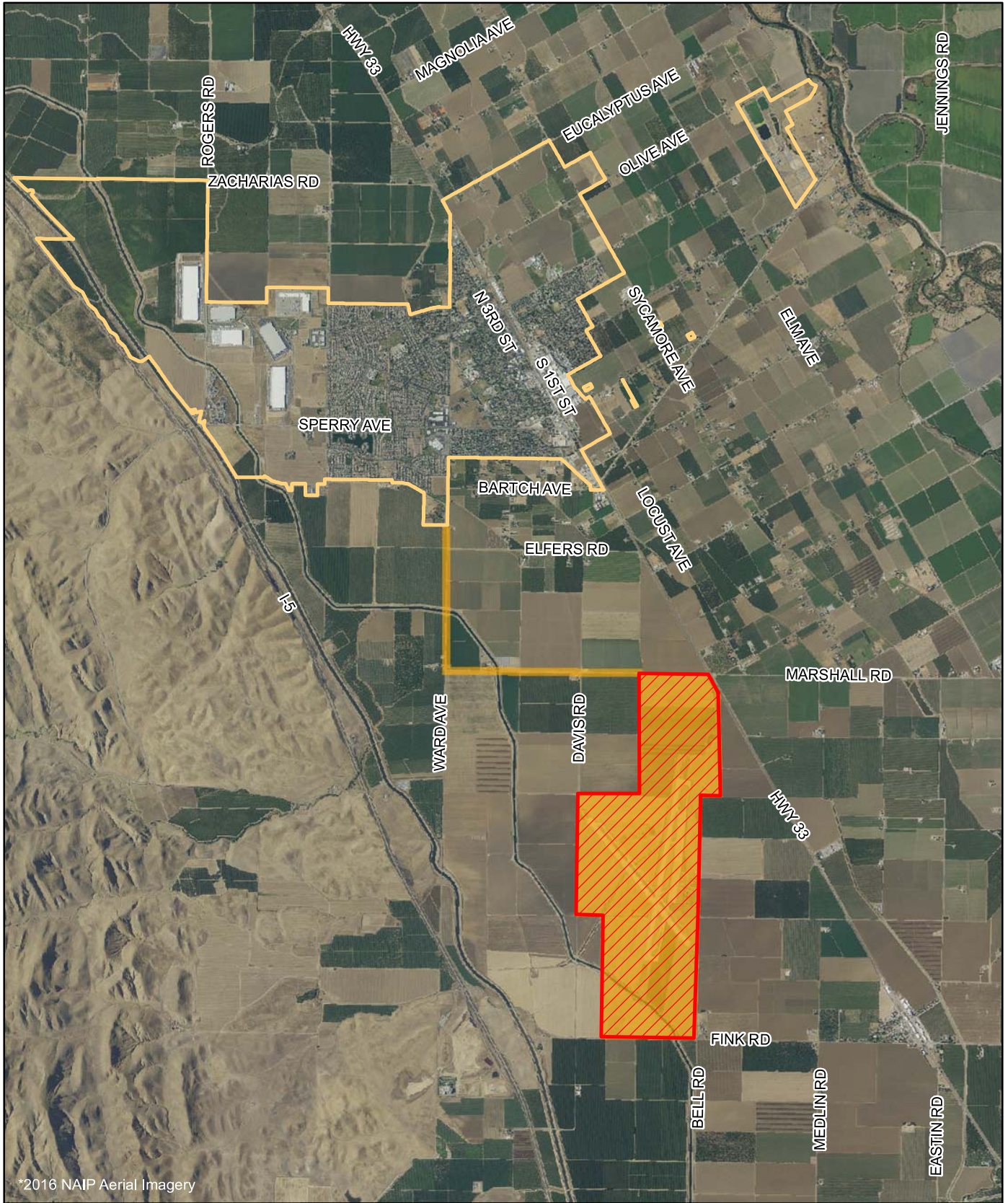


**Figure B4**  
CLIBP Stand Alone Non-Potable  
Water System

**Figure Depictions of a Conceptual City of Patterson Water Supply  
for the Crows Landing Industrial Business Park**

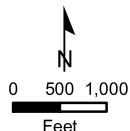
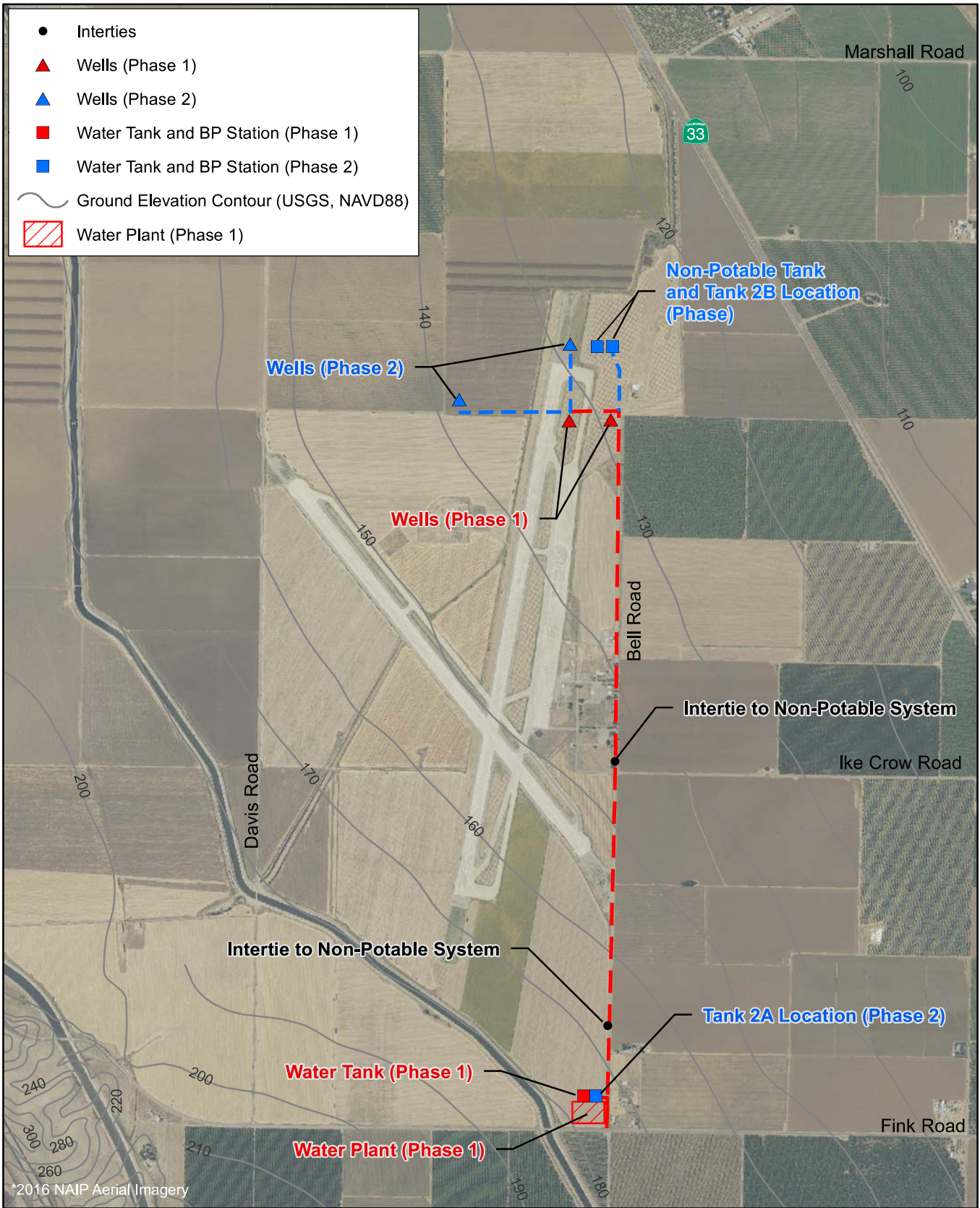
**Alternative C**

---



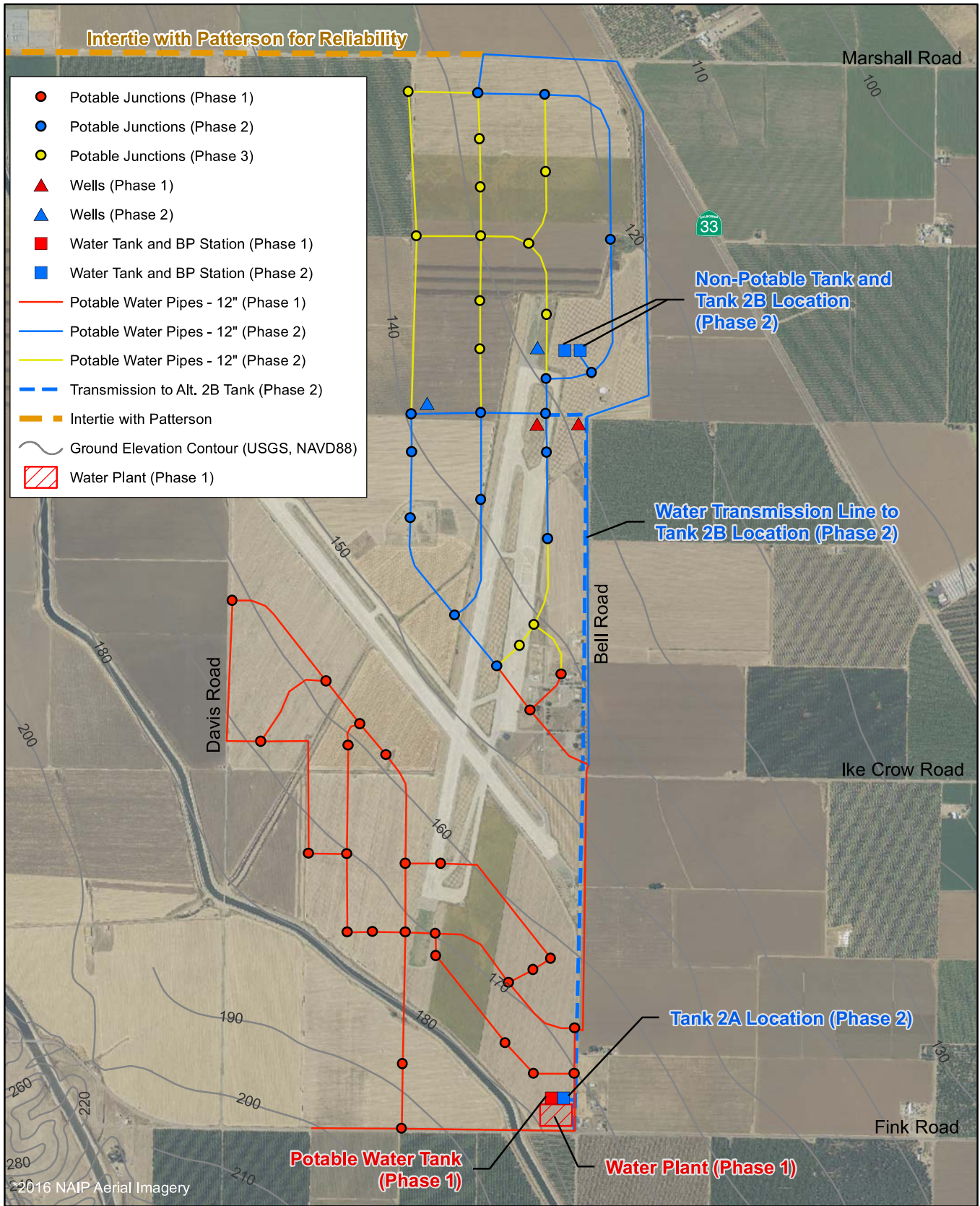
\*2016 NAIP Aerial Imagery

	<ul style="list-style-type: none"> <li><span style="display: inline-block; width: 20px; height: 10px; background-color: yellow; border: 1px solid black; margin-right: 5px;"></span> Service Area Extension</li> <li><span style="display: inline-block; width: 20px; height: 10px; background: repeating-linear-gradient(45deg, transparent, transparent 2px, red 2px, red 4px); border: 1px solid red; margin-right: 5px;"></span> Crows Landing Industrial Business Park</li> <li><span style="display: inline-block; width: 20px; height: 10px; border: 1px solid yellow; margin-right: 5px;"></span> City of Patterson</li> </ul>	<p style="text-align: right;"><b>Figure C1</b> <b>CLIBP Water System Extension of</b> <b>City of Patterson Water Service Area</b></p>
--	--	---



**Figure C2**  
**CLIBP Raw Water System for**  
**City of Patterson Extension of**  
**Service Area**





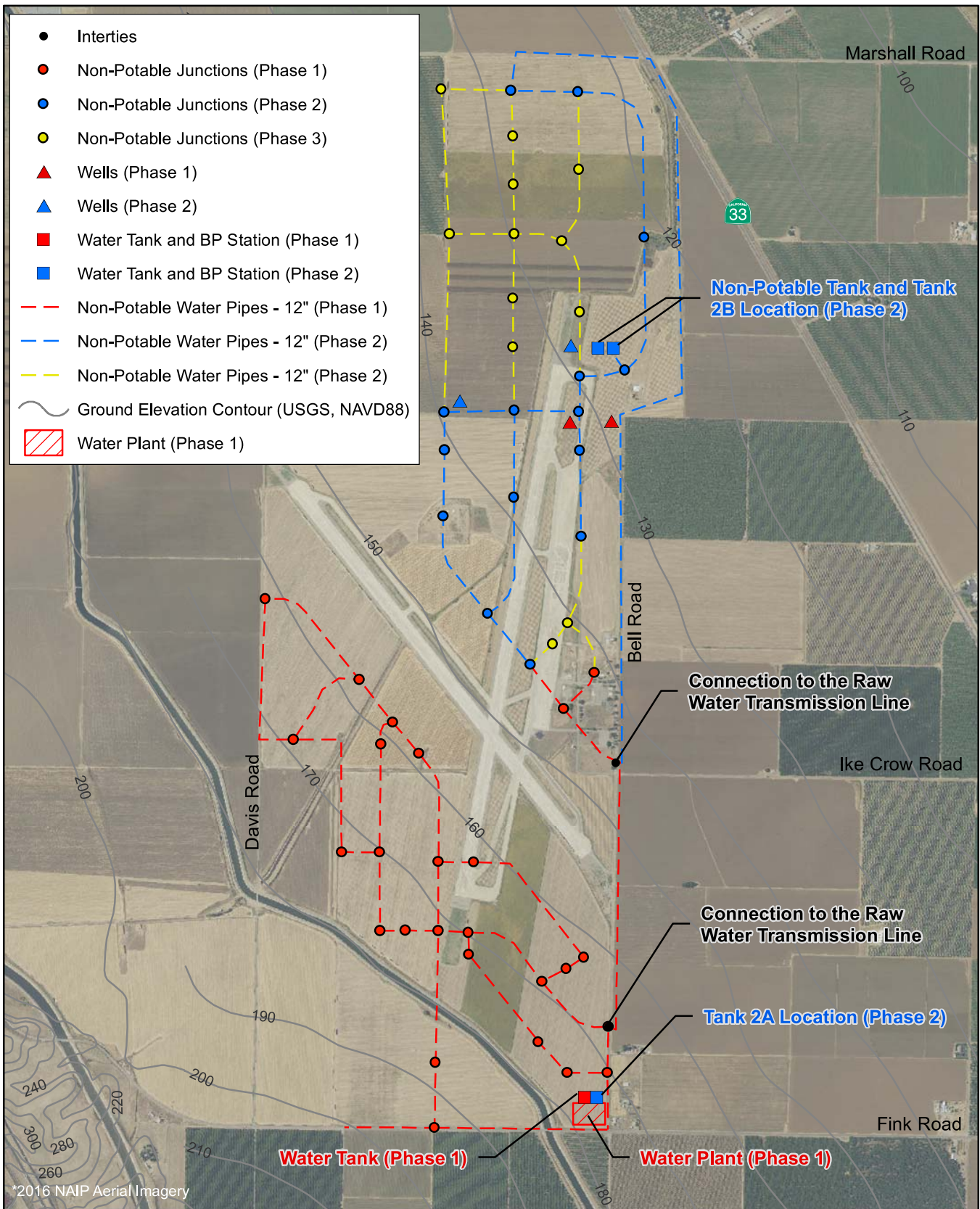
EST. 1968  
**PROVOST & PRITCHARD**  
 CONSULTING GROUP  
 An Employee Owned Company

0 500 1,000  
 Feet

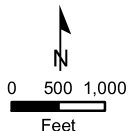


**Figure C3**  
 CLIBP Area Potable Water System for  
 City of Patterson Extension of  
 Service Area

**PUR**  
 Safe Water for All



\*2016 NAIP Aerial Imagery



**Figure C4**  
**CLIBP Non-Potable Water System for**  
**City of Patterson Extension**  
**of Service Area**

**CROWS LANDING INDUSTRIAL BUSINESS PARK**

**SANITARY SEWER INFRASTRUCTURE AND  
FACILITIES STUDY**

November 30, 2017 by

AECOM Technical Services, Inc.  
2020 L Street, Suite 400  
Sacramento, CA 95811  
(916) 414-5800

**AECOM**



Prepared for:  
Stanislaus County  
1010 10<sup>th</sup> Street  
Modesto, CA 95354  
(209) 525-4130

Prepared by:  
VVH Consulting Engineers  
126 Drake Avenue  
Modesto, CA 95350  
(209) 568-4477

January 30, 2015

# Table of Contents

- 1.0 Introduction .....1**
- 1.1 Study Background and Purposes ..... 1
- 1.2 Study Purpose ..... 1
- 1.3 Overall System Planning Assumptions..... 2
  
- 2.0 Background investigation .....3**
- 2.1 Topography ..... 3
- 2.2 Existing Sewer Facilities ..... 3
- 2.3 Regionalization..... 4
  
- 3.0 Proposed Land Use and Sewer Generation Projections for project Service Areas.....5**
- 3.1 Proposed Land Use ..... 5
- 3.2 Service Areas..... 5
- 3.3 Analysis Methodology..... 5
  - 3.3.1 Design Flow, Peaking Factor, and Inflow and Infiltration ..... 6
- 3.4 Design Flow Projections..... 6
  - 3.4.1 Buildout Design Flow Projections..... 6
  - 3.4.2 Phase 1 Design Flow Projections for Phase 1A and Phase 1B Development ..... 7
  - 3.4.3 Phase 2 Design Flow Projections..... 8
  - 3.4.4 Phase 3 Design Flow Projections..... 8
- 3.5 Design LOADING Projections ..... 9
  
- 4.0 Proposed sanitary sewer system infrastructure .....11**
- 4.1 Proposed Sanitary Sewer Infrastructure..... 11
  
- 5.0 System Design Criteria .....15**
- 5.1 Gravity Collection and Conveyance ..... 15
  - 5.1.1 Manning’s Coefficient ..... 15
  - 5.1.2 Flow Depth Criteria ..... 15
  - 5.1.3 Design Velocity and Minimum Slope..... 15
- 5.2 LIFT Stations and Force Mains ..... 16
  
- 6.0 Sewer Collection and System Layout .....17**
- 6.1 Gravity Trunk lines ..... 17
- 6.2 Lift Stations and Force mains..... 17
- 6.3 Infrastructure IMPLEMENTATION Plan Summary..... 17
  
- 7.0 Sewer Treatment, Storage, and Disposal.....20**
- 7.1 CITY OF PATTERSON WASTEWATER COLLECTION AND Treatment SYSTEMS ..... 20
  - 7.1.1 City of Patterson Wastewater Collection System ..... 20
  - 7.1.2 City of Patterson WQCF Treatment Capacity ..... 21
- 7.2 WASTEWATER TREATMENT and Disposal ALTERNATIVES..... 21



7.2.1	Individual On-Site Treatment and Disposal.....	21
7.2.2	Phased Wastewater On-Site Treatment and Disposal .....	23
7.2.3	Permitting and Operations for On-Site Treatment and Disposal.....	26
<b>8.0</b>	<b>Overall Findings .....</b>	<b>27</b>
8.1	Alternatives.....	27

## LIST OF TABLES

Table 3.1	Sewer Loading Factors
Table 3.2	Project Buildout Sanitary Sewer Generation Projections
Table 3.3	Phase 1 (Total) Sanitary Sewer Generation Projections
Table 3.3a	Phase 1A Sanitary Sewer Generation Projections
Table 3.4	Phase 2 Sanitary Sewer Generation Projections
Table 3.5	Phase 3 Sanitary Sewer Generation Projections
Table 3.6	Raw Wastewater Constituent Concentrations
Table 3.7	Raw Wastewater Constituent Load Projections
Table 4.1	Phase 1 Infrastructure Probable Cost Estimate
Table 4.2	Phase 2 Infrastructure Probable Cost Estimate
Table 4.3	Phase 3 Infrastructure Probable Cost Estimate
Table 4.4	Estimated Sanitary Sewer Connection Fee
Table 5.1	Minimum Slope Criteria
Table 6.1	Existing Available Pipe Capacity
Table 7.1	Water Quality Requirements for Effluent Disposal Assumptions

## LIST OF FIGURES

Figure 1.1	Crows Landing Industrial Park – Conceptual Phasing Map
Figure 2.1	Existing Sanitary Sewer System with Future CLIBP Force Main and Lift Station Map
Figure 4.1	Phase 1 Sanitary Sewer System Layout and Peak Wet Weather Flow Results
Figure 4.2	Phases 1 and 2 Sanitary Sewer System Layout and Peak Wet Weather Flow Results
Figure 4.3	Phases 1, 2, and 3 Sanitary Sewer System Layout and Peak Wet Weather Flow Results
Figure 4.4	Sewer Collection Service Area Map
Figure 7.1	Septic Tank Effluent Biofilter (Orenco)
Figure 7.2	Water Balance Graph for 250 Irrigated Acres

## APPENDIX

Appendix A	– Sewer Calculations
Appendix B	– Model Outputs
Appendix C	– Potential Impacts to Patterson Wastewater Facilities from CLIBP (TM)
Appendix D	– Water Balance Data

## 1.0 INTRODUCTION

Section 1 states the study background and purposes, study area, and overall system planning assumptions.

### 1.1 STUDY BACKGROUND AND PURPOSES

The Crows Landing Industrial Business Park Project (Project) is an approximately 1,528-acre conceptually planned development that encompasses the reuse of the former Crows Landing Air Facility, which was decommissioned by NASA in the late 1990s, as shown in Figure 1.1.

This Sanitary Sewer Infrastructure and Facilities Study provides information required for the County to better assess the feasibility of the planned development by defining the sanitary sewer system infrastructure improvements necessary to accommodate planned development in the proposed industrial business park, herein referred to collectively as the “Project.” The scope of this plan includes the following major tasks:

- Compute the projected sewer flows generated by the Project based on the projected land use.
- Determine the overall preliminary sewer system layout and sizing using the proposed land use and circulation plan for collection, conveyance, treatment, and disposal.

The findings of this study are based on available information and are subject to change once more detailed engineering analyses are performed as the Project progresses.

### 1.2 STUDY PURPOSE

The Project study area includes the Project site, the Western Hills Water District sewer conveyance facilities west of the Project site, and the City of Patterson Water Quality Control Facility (WQCF) north of the Project site.

The Project addresses the reuse of the former Crows Landing Air Facility, encompassing approximately 1,528 acres in the western portion of Stanislaus County west of State Route 33 and east of Interstate 5, southwest of Patterson, and approximately 1 mile west of the unincorporated community of Crows Landing (Figure 1.1). The Project is bounded on the east by Bell Road, on the south by Fink Road, on the west by Davis Road, and on the north by Marshall Road and State Route 33. The Delta-Mendota Canal traverses the southern portion of the Project in a northwest/southeast direction. Little Salado Creek enters the Project site along the western property boundary slightly northeast of the Delta-Mendota Canal and terminates near the intersection of Marshall Road and State Route 33. The Project site topography generally slopes down in a northeasterly direction with an elevation change of approximately 80 feet, with the lowest elevation near the intersection of State Route 33 and Marshall Road. The site includes vehicle and aviation improvements associated with the former air facility which are currently being leased for agricultural use.

### 1.3 OVERALL SYSTEM PLANNING ASSUMPTIONS

Stanislaus County Department of Public Works Standards and Specifications Section 6.5 states:

The sewer system shall conform to the requirements of the sewer district in which the development is located. If the development is located outside of a sewer district, then the sewer system shall be designed and constructed in conformance with the City of Modesto sanitary sewer standards.

The proposed project is not located within a sewer district. Therefore, the overall system planning assumptions for the sewer system in this study are based on *City of Modesto Public Works Department Standard Specifications 2006* (COM Standards) and the *City of Modesto Wastewater Collection System Master Plan, March 2000* (COM Wastewater Master Plan). In the case where design guidelines and criteria are not provided by the COM Standards or the COM Wastewater Master Plan, assumptions are made based on a comparative analysis of sewer generation rates for local cities and agencies, including the City of Modesto, and typical values published in the *Wastewater Engineering Treatment and Reuse* (Metcalf and Eddy, Inc. 2003. New York: The McGraw-Hill Companies, Inc.).

## 2.0 BACKGROUND INVESTIGATION

Section 2 discusses topography and the existing sewer facilities at and around the Project.

### 2.1 TOPOGRAPHY

The Project site terrain is composed of gently sloping land. Terrain in the study area rises from approximately 120 feet above mean sea level in the northeastern corner of the Project site (near the Marshall Road / State Route 33 intersection) to approximately 200 feet above mean sea level at the southwestern corner of the Project site (immediately north of Fink Road).

### 2.2 EXISTING SEWER FACILITIES

An existing sewage storage and treatment system is located within the Project site north of the existing north-south runway. This existing sewer system is composed of approximately 5,400 feet of sewage piping, an Imhoff processing tank, a sludge drying bed, and three settling ponds. The existing sewer system is connected to a sink and toilet in Building 109 (Shaw Environmental, Inc. 2006). The County does not anticipate using the existing treatment system.

Existing sewer facilities outside the Project site, but within the broader Project study area, include an existing 18-inch-diameter Western Hills Water District sewer trunk line which is located approximately 1.2 miles west of the Project site. The trunk line conveys sanitary sewer flows from the Diablo Grande development, which is located approximately 8 miles west of the Project Site, to the City of Patterson Water Quality Control Facility located approximately 5 miles north of the Project (Figure 2.1). The trunk line crosses Interstate 5 and the California Aqueduct, continues west along Oak Flat Road, then north along Ward Ave.

The City of Modesto (COM) Jennings Road Secondary/Tertiary Wastewater Treatment Plant (Jennings Plant) is located approximately 7 miles north of the Project (Figure 2.1). The COM Jennings Plant receives primary treated effluent from the COM Sutter Avenue Primary Wastewater Treatment Plant located approximately 14 miles northeast of the Project site. Tertiary treated effluent produced by the COM Jennings Plant is disposed of by beneficial irrigation of City-owned lands, by storing treated effluent in reservoirs, and by discharging treated effluent into the San Joaquin River during the months of October through May. Discharges to the San Joaquin River are based on the river flow, and irrigation disposal is dictated by the agronomic conditions and farming operations.

The City of Patterson Water Quality Control Facility (WQCF) receives effluent from the City of Patterson and the community of Diablo Grande. The treatment plant has a design capacity of approximately 2.25 MGD. The average annual wastewater flows to the WQCF are approximately 1.4 MGD. Treatment is accomplished through three treatment processes at the facility including the South Activated Sludge Treatment System (SASTS), the North Activated Sludge Treatment System (NASTS), and the Advanced Integrated Pond System (AIPS). These treatment systems use a combination of aeration, circulation, nitrogen removal, clarifiers, aerobic digesters, percolation ponds, and dewatering beds. The treatment plant contains several percolation ponds for effluent disposal. Biosolids are spread over agricultural lands and also disposed of at a sanitary landfill (City of Patterson Wastewater Master Plan, 2010).



## 2.3 REGIONALIZATION

As the San Joaquin Valley continues to develop, a number of factors indicate that regional infrastructure planning could provide benefits for local agencies and residents alike. Increasing water demands; periods of drought and water supply shortages; environmental concerns, regulations, and adjudications; aquifer overdrafts and declining groundwater table elevations; shrinking deliveries of surface water entitlements; expanding threats to both groundwater and surface water quality; and increasing quality standards for potable water, non-potable water, storm water, and effluents have all impacted water resources and planning in the Central Valley. Regionalization is proving an effective solution to many of these concerns in larger metropolitan areas throughout the state.

While the economies of scale afforded by regional infrastructure solutions generally provide financial benefits to project stakeholders, community participation in the planning and utilization of such systems is an important factor in their successful implementation. The County is reaching out to local municipalities, unincorporated communities, water districts, community service districts, and a fire protection district to plan for regional infrastructure solutions that could provide benefits to multiple stakeholders. Conversations are ongoing regarding regional solutions for sanitary sewer treatment. Potential future opportunities for regionalization related to wastewater include wastewater conveyance, wastewater treatment, and recycled water supply for potential use in agricultural and/or landscape irrigation, community fire protection, non-potable industrial use, or non-potable use in commercial or residential buildings.

Options for managing regional services include agreements with local municipalities; agreements with existing community services districts and/or water districts; implementation of a joint powers agreement (JPA); or a new community service district or water district. The advantages of each potential agreement vary depending on the extent of regionalization and potential customer mix. The County recognizes that both surrounding communities and the Project can jointly benefit from such cooperation and is dedicated in continuing their efforts in the development of these services and management systems.

The preferred alternative for the Project is to connect to the Western Hills Water District sanitary sewer effluent conveyance system to transport Project effluent to and through the City of Patterson's wastewater conveyance system, and ultimately to the City of Patterson Water Quality Control Facility for treatment. The County intends to purchase capacity in the Ward Ave. trunk line from Western Hills Water District. This alternative could be accomplished through coordination with the City of Patterson to connect to the City's existing and future sewer trunk line services. Section 6 describes the proposed phasing for connections to the City's existing and proposed trunk lines to accommodate the Crows Landing Industrial Business Park buildout for Phases 1, 2, and 3.

### **3.0 PROPOSED LAND USE AND SEWER GENERATION PROJECTIONS FOR PROJECT SERVICE AREAS**

Section 3 provides an overview of the proposed project land use, service areas, analysis methodology of calculating projected sewer generation rates, and provides the projected sewer generation rates for the Project.

#### **3.1 PROPOSED LAND USE**

The Project proposes to develop the 1,528-acre site from its current land use into a business park with primarily public facilities, logistics, industrial, and business park land uses with a small amount of aviation-related land use. This study assumes that 1,274 acres of the Project will be developable and 1,261 of those acres will require sanitary sewer services. Figure 1.1 shows the land use designations and acreages for the Project based on the Crows Landing Industrial Business Park Land Use Plan. The Project area designated in Figure 1.1 as Phase 1A (Fink Road Corridor) will be developed first.

#### **3.2 SERVICE AREAS**

Due to the Project's phasing, the Project is divided into two sewer collection service areas, designated as Service Area 1 and Service Area 2. Service Area 1 includes the existing airfield and all areas north of the existing airfield, including the portions associated with Phase 1B, Phase 2, and Phase 3. Service Area 2 includes all areas south of the existing airfield, including the portion associated with Phase 1B and the entirety of Phase 1A. The proposed Land Use Plan, the Conceptual Phasing Map, and the United States Geological Survey (USGS) Crows Landing 7.5-Minute Series Quadrangle Map were used together to determine sewer shed areas for the Project site. Figure 4.4 shows the service area boundaries for the Project. Sanitary sewer service is not proposed within the existing airport crash zone easements.

#### **3.3 ANALYSIS METHODOLOGY**

The City of Modesto's (COM) Standard Specification (Table 5.1) lists acreage flow estimates for sewer flow projections. The Project is predominantly public facilities, logistics, industrial, and business park land uses, and the COM standards only provide flow values for light industrial. As a result, assumptions are made for sewer generation rates in place of the COM Standards unit sewer generation rates as described in Section 1.3. For the purposes of this study, the sewer flow rate applied to public facilities, logistics, industrial, and business park land use is a conservative estimate considered to represent general industrial activities since sewer generation rates are highly variable for different industrial land uses, and particular land uses for industrial development are not defined for the Project.

Sewer generation projections developed for this study (Table 3.2) were based on the accepted industry standard loading factors described in Table 3.1 and input from the County of Stanislaus (County).

**Table 3.1 – Sewer Loading Factors**

Land Use	Loading Factor
Airport Users <sup>1</sup> - Dry Weather Loading Factor	4 gpc/day
General Land Uses - Dry Weather Loading Factor <sup>2</sup>	1,000 gpd/acre
Wet Weather Loading Factor <sup>3</sup>	100 gpd/acre
Peaking Factor	3

\*gpc = gallons per capita, gpd = gallons per day

Average Dry Weather Flow (ADWF) projections for industrial and aviation-related land uses were developed by multiplying the unit sewer loading factors for each land use category by either the proposed acreage for general industrial land uses or the assumed airport daily usage of 100 people per day for aviation-related uses. Peak Dry Weather Flow (PDWF) was estimated by multiplying the ADWF by the peaking factor. Estimates for inflow and Infiltration (I/I) were determined by multiplying the proposed acreage for each land use by the wet-weather loading factor.

### 3.3.1 Design Flow, Peaking Factor, and Inflow and Infiltration

Sewer flow rates vary based on the time of day, week, season of the year, type of dischargers, etc. Design flow rates are determined based on the peak wet weather flow (PWWF) rates. PWWF are calculated by adding the peak dry weather flow (PDWF) rates plus system inflow and infiltration (I/I) rates, and are typically used to determine the required capacity of collection and conveyance infrastructure. As described in the previous section, the PDWF rate for the Project is calculated by multiplying the average dry weather flow (ADWF) rate by a peaking factor (PF) of 3. I/I flow rates account for additional non-sewer flows that infiltrate the system typically during and after wet weather events and were accounted for using the wet-weather loading factor. Groundwater infiltration/inflow is extraneous water that enters the sewer system through defective joints and cracks in sewer mains, manhole walls, and sewer laterals, as well as through direct surface drainage connections or manhole links. For the purposes of this study, I/I flow is generally represented as a constant flow rate since it does not vary significantly over the course of a typical day. I/I flow rates are estimated to be 100 gpd/acre per the Metcalf & Eddy Wastewater Engineering design reference manual.

## 3.4 DESIGN FLOW PROJECTIONS

Design flow projections are provided for the full build-out condition as well as for Phase 1A, Phase 1B, Phase 2, and Phase 3.

### 3.4.1 Buildout Design Flow Projections

The proposed sewer system must be capable of collecting and conveying the PDWF and an instantaneous peak wet weather design flow as presented in Table 3.2. The ADWF, PDWF, and PWWF rates estimated for the Project are 0.85 MGD, 2.54 MGD, and 2.66 MGD, respectively.

<sup>1</sup> Metcalf & Eddy, Wastewater Engineering, McGraw Hill, 4<sup>th</sup> Edition page 157 Table 3-2

<sup>2</sup> Metcalf & Eddy, Wastewater Engineering, McGraw Hill, 4<sup>th</sup> Edition page 162

<sup>3</sup> Metcalf & Eddy, Wastewater Engineering, McGraw Hill, 4<sup>th</sup> Edition page 165

**Table 3.2 – Project Buildout Sanitary Sewer Generation Projections**

Sewer Shed Phase ID	Land Use	Acreage	Average Dry Weather Flow Planning Value (gpc/day)	Average Dry Weather Flow Planning Value (gpd/ac)	Peaking Factor	Inflow & Infiltration (gpd/ac)	Average Dry Weather Flow (gpd)	Peak Dry Weather Flow (gpd)	Inflow & Infiltration (gpd)	Peak Wet Weather Flow (gpd)
1B*	General Aviation	370.0	4.0	-	3.00	100	400	1,200	37,000	38,200
1B	Public Facilities	15.0	-	1,000	3.00	100	15,000	45,000	1,500	46,500
1A	Logistics	52.0	-	1,000	3.00	100	52,000	156,000	5,200	161,200
1B	Logistics	138.0	-	1,000	3.00	100	138,000	414,000	13,800	427,800
1A	Industrial	41.0	-	1,000	3.00	100	41,000	123,000	4,100	127,100
1B	Industrial	110.0	-	1,000	3.00	100	110,000	330,000	11,000	341,000
1A	Business Park	10.0	-	1,000	3.00	100	10,000	30,000	1,000	31,000
1B	Business Park	28.0	-	1,000	3.00	100	28,000	84,000	2,800	86,800
2*	Aviation Related	46.0	4.0	-	3.00	100	400	1,200	4,600	5,800
2	Public Facilities	35.0	-	1,000	3.00	100	35,000	105,000	3,500	108,500
2	Logistics	57.0	-	1,000	3.00	100	57,000	171,000	5,700	176,700
2	Industrial	71.0	-	1,000	3.00	100	71,000	213,000	7,100	220,100
2	Business Park	14.0	-	1,000	3.00	100	14,000	42,000	1,400	43,400
3	Public Facilities	18.0	-	1,000	3.00	100	18,000	54,000	1,800	55,800
3	Logistics	102.0	-	1,000	3.00	100	102,000	306,000	10,200	316,200
3	Industrial	128.0	-	1,000	3.00	100	128,000	384,000	12,800	396,800
3	Business Park	26.0	-	1,000	3.00	100	26,000	78,000	2,600	80,600
		<b>1,261</b>	-				<b>845,800</b>	<b>2,537,400</b>	<b>126,100</b>	<b>2,663,500</b>

*Notes*  
 \* Average Dry Weather Flow estimations for aviation usage based on 100 people per day.  
 \* Land use for 13 acres of multimodal transportation/green space corridor and 254 acres of internal project infrastructure is not included as part of the 1,528 total project acreage.

**3.4.2 Phase 1 Design Flow Projections for Phase 1A and Phase 1B Development**

Phase 1 ADWF, PDWF, and PWWF rates estimated for the Project are 0.39 MGD, 1.18 MGD, and 1.26 MGD, respectively, as presented in Table 3.3.

Phase 1A ADWF, PDWF, and PWWF rates estimated for the Project are 0.10 MGD, 0.310 MGD, and 0.32 MGD, respectively, as presented in Table 3.3a.

**Table 3.3 – Phase 1 (Total) Sanitary Sewer Generation Projections**

Sewer Shed Phase ID	Land Use	Acreage	Average Dry Weather Flow Planning Value (gpc/day)	Average Dry Weather Flow Planning Value (gpd/ac)	Peaking Factor	Inflow & Infiltration (gpd/ac)	Average Dry Weather Flow (gpd)	Peak Dry Weather Flow (gpd)	Inflow & Infiltration (gpd)	Peak Wet Weather Flow (gpd)
1B*	General Aviation	370.0	4.0	-	3.00	100	400	1,200	37,000	38,200
1B	Public Facilities	15.0	-	1,000	3.00	100	15,000	45,000	1,500	46,500
1A	Logistics	52.0	-	1,000	3.00	100	52,000	156,000	5,200	161,200
B	Logistics	138.0	-	1,000	3.00	100	138,000	414,000	13,800	427,800
1A	Industrial	41.0	-	1,000	3.00	100	41,000	123,000	4,100	127,100
1B	Industrial	110.0	-	1,000	3.00	100	110,000	330,000	11,000	341,000
1A	Business Park	10.0	-	1,000	3.00	100	10,000	30,000	1,000	31,000
1B	Business Park	28.0	-	1,000	3.00	100	28,000	84,000	2,800	86,800
		<b>764</b>					<b>394,400</b>	<b>1,183,200</b>	<b>76,400</b>	<b>1,259,600</b>

Notes  
 \* - Average Dry Weather Flow estimations for aviation usage based on 100 people per day

**Table 3.3a – Phase 1A Sanitary Sewer Generation Projections**

Sewer Shed Phase ID	Land Use	Acreage	Average Dry Weather Flow Planning Value (gpc/day)	Average Dry Weather Flow Planning Value (gpd/ac)	Peaking Factor	Inflow & Infiltration (gpd/ac)	Average Dry Weather Flow (gpd)	Peak Dry Weather Flow (gpd)	Inflow & Infiltration (gpd)	Peak Wet Weather Flow (gpd)
1A	Logistics	52.0	-	1,000	3.00	100	52,000	156,000	5,200	161,200
1A	Industrial	41.0	-	1,000	3.00	100	41,000	123,000	4,100	127,100
1A	Business Park	10.0	-	1,000	3.00	100	10,000	30,000	1,000	31,000
		<b>103</b>					<b>103,000</b>	<b>309,000</b>	<b>103,000</b>	<b>319,300</b>

Notes  
 \* - Average Dry Weather Flow estimations for aviation usage based on 100 people per day

**3.4.3 Phase 2 Design Flow Projections**

Phase 2 ADWF, PDWF, and PWWF rates estimated for the Project are 0.24 MGD, 0.67 MGD, and 0.69 MGD, respectively, as presented in Table 3.4.

**3.4.4 Phase 3 Design Flow Projections**

Phase 3 ADWF, PDWF, and PWWF rates estimated for the Project are 0.27 MGD, 0.82 MGD, and 0.85 MGD, respectively, as presented in Table 3.5.

**Table 3.4 – Phase 2 Sanitary Sewer Generation Projections**

Sewer Shed Phase ID	Land Use	Acreage	Average Dry Weather Flow Planning Value (gpc/day)	Average Dry Weather Flow Planning Value (gpd/ac)	Peaking Factor	Inflow & Infiltration (gpd/ac)	Average Dry Weather Flow (gpd)	Peak Dry Weather Flow (gpd)	Inflow & Infiltration (gpd)	Peak Wet Weather Flow (gpd)
2	Aviation Related	46.0		1,000	3.0	100	46,000	138,000	4,600	142,600
2	Public Facilities	35.0	-	1,000	3.0	100	35,000	105,000	3,500	108,500
2	Logistics	57.0	-	1,000	3.0	100	57,000	171,000	5,700	176,700
2	Industrial	71.0	-	1,000	3.0	100	71,000	213,000	7,100	220,100
2	Business Park	14.0	-	1,000	3.0	100	14,000	42,000	1,400	43,400
		<b>223</b>					<b>223,000</b>	<b>669,000</b>	<b>22,300</b>	<b>691,300</b>

**Table 3.5 – Phase 3 Sanitary Sewer Generation Projections**

Sewer Shed Phase ID	Land Use	Acreage	Average Dry Weather Flow Planning Value (gpc/day)	Average Dry Weather Flow Planning Value (gpd/ac)	Peaking Factor	Inflow & Infiltration (gpd/ac)	Average Dry Weather Flow (gpd)	Peak Dry Weather Flow (gpd)	Inflow & Infiltration (gpd)	Peak Wet Weather Flow (gpd)
3	Public Facilities	18	-	1,000	3.0	100	18,000	54,000	1,800	55,800
3	Logistics	102	-	1,000	3.0	100	102,000	306,000	10,200	316,200
3	Industrial	128	-	1,000	3.0	100	128,000	384,000	12,800	396,800
3	Business Park	26	-	1,000	3.0	100	26,000	78,000	2,600	80,600
		<b>274</b>					<b>274,000</b>	<b>822,000</b>	<b>27,400</b>	<b>849,400</b>

### 3.5 DESIGN LOADING PROJECTIONS

Wastewater constituent loading projections were estimated for the aforementioned AWFDF flow projections for purposes of wastewater treatment and disposal. These are provided for the full build-out condition as well as for Phase 1, Phase 2, and Phase 3.

Raw (untreated) wastewater constituent loadings were calculated using the following planning level concentrations. These are commonly used planning level numbers for domestic sewage used for new developments. They also conform to the average concentrations seen at the COP WQCF.

**Table 3.6 – Raw Wastewater Constituent Concentrations**

Raw Wastewater Constituent	Average Concentration
Biochemical Oxygen Demand (BOD <sub>5</sub> ):	300 mg/L
Total Suspended Solids (TSS):	300 mg/L
Total Kjeldahl Nitrogen (TKN):	50 mg/L

Constituent loadings are presented in pounds per day (lb./day) as:

- Average Load (at ADWF) and
- Peak Load (Average Load X 1.3)

A summary of the constituent loading projections for all phases is presented in Table 3.7. These include both average and peak loadings for the ADWF for each phase of development.

**Table 3.7 – Raw Wastewater Constituent Load Projections**

Parameter	Units	Phase 1 (A&B)	Phase 2	Phase 3	Buildout
ADWF	MGD	0.394	0.223	0.274	0.891
Average BOD5 Load	lb./day	986	558	686	2,229
Peak BOD5 Load	lb./day	1,282	725	891	2,898
Average TSS Load	lb./day	986	558	686	2,229
Peak TSS Load	lb./day	1,282	725	891	2,898
Average TKN Load	lb./day	164	93	114	372
Peak TKN Load	lb./day	214	121	149	484

## 4.0 PROPOSED SANITARY SEWER SYSTEM INFRASTRUCTURE

Section 4 presents an overview of the proposed sanitary sewer infrastructure for the Project. Bentley's SewerGEMS v8i software was used for this analysis. Information from the Crows Landing Industrial Business Park Sanitary Sewer Infrastructure and Facilities Study, conducted by VVH Consulting Engineers in January 2015, was used to construct the hydraulic model. Sewer loadings were allocated throughout the model using the Thiessen polygon method. This method assigns each manhole an area of influence, which is overlaid with the site land use map and wastewater loading factors to calculate loadings for each manhole. Wastewater collection systems are typically sized for peak flows; therefore, for the purposes of this study, the peak flow scenario was used for the analysis. The analysis was performed under steady-state conditions.

Additionally, the proposed sanitary system layout was developed for planning purposes and further design of the proposed system will need to be conducted for the final design of the system layout including pipe sizing, slopes, and costs.

### 4.1 PROPOSED SANITARY SEWER INFRASTRUCTURE

Sanitary sewer infrastructure required as part of Phase 1 improvements includes gravity trunk mains, a 2.70-MGD sanitary sewer lift station southwest of the Marshall Road and State Route 33 intersection, a 0.32-MGD sanitary lift station south of the airfield near the Delta Mendota Canal, and a force main within Marshall Road to convey effluent to the existing Western Hills Water District trunk main in Ward Ave. The gravity trunk mains and the lift station to be constructed in Phase 1A improvements are sized to accommodate ultimate expansion within the business park, and the force main constructed in Phase 1A is sized to accommodate effluent from Phases 1, 2, and 3. See Figure 4.1 for the Phase 1 Sanitary Sewer System Map.

Construction of the Phase 1A improvements include a gravity trunk main system with approximately 10,506 lineal feet of 18-inch-diameter pipe, 2,992 lineal feet of 12-inch-diameter pipe, 2,146 lineal feet of 8-inch-diameter pipe, approximately 56 manholes, construction of a 2.66-MGD sanitary sewer lift station, construction of a 0.32-MGD sanitary sewer lift station, construction of approximately 12,400 lineal feet of 12-inch sanitary sewer force main, a temporary connection to the existing Western Hills Water District's 18-inch sanitary sewer trunk line, and a crossing under the Delta Mendota Canal. Construction of the Phase 1B improvements include approximately 518 lineal feet of 15-inch-diameter pipe, 3,028 lineal feet of 12-inch-diameter pipe, 5,367 lineal feet of 10-inch-diameter pipe, 17,228 lineal feet of 8-inch-diameter pipe, and approximately 28 manholes. The estimated cost for the total Phase 1 development is approximately \$12 million (Table 4.1).

Sanitary sewer infrastructure required as part of Phase 2 improvements include gravity trunk mains to connect to existing sanitary sewer infrastructure constructed with Phase 1. See Figure 4.2 for the Phase 2 Sanitary Sewer System Map. Construction of the Phase 2 gravity trunk main system, including approximately 1,318 lineal feet of 12-inch-diameter pipe, 971 lineal feet of 10-inch-diameter pipe, 7,661 lineal feet of 8-inch-diameter pipe, 20 manholes, removal of the temporary connection to the Western Hills Water District's sanitary sewer trunk line, and install approximately 7,870 LF of 12-inch-diameter force main paralleling the existing Western Hills Water District's sewer trunk line along Ward Avenue between Marshall Road and Bartch Avenue, is estimated to cost approximately \$2.8 million (Table 4.2).



Development of Phase 3 proposes construction of backbone infrastructure to provide sanitary sewer service to the Phase 3 areas south of Marshall Road. Construction of the Phase 3 gravity trunk main system, including approximately 3,037 lineal feet of 10-inch-diameter pipe, 13,326 lineal feet of 8-inch-diameter pipe, and 33 manholes, is estimated to cost approximately \$2.5 million (Table 4.3).

**Table 4.1 – Phase 1 Infrastructure Probable Cost**

Description		Quantity	Unit Cost (\$)	Total Cost (\$)
<b>Phase 1A Infrastructure</b>				
1.	18" Pipe	10,506 LF	\$130	\$1,366,000
2.	12" Pipe	2,992 LF	\$100	\$300,000
3.	8" Pipe	2,146 LF	\$80	\$172,000
4.	12" Force Main	12,400 LF	\$120	\$1,488,000
5.	Type "A" Case I Manhole	56 EA	\$9,000	\$504,000
6.	2.70-MGD Lift Station	1 LS	\$1,750,000	\$1,750,000
7.	0.32-MGD Lift Station	1 LS	200,000	\$200,000
8.	Tunneled Crossing (Delta Mendota Canal South of Air Field)	300 LF	\$250	\$75,000
Subtotal				5,855,000
Engineering Costs (20%)				\$1,171,000
Contingencies (20%)				\$1,406,000
<b>Subtotal Phase 1A Development Costs</b>				<b>\$8,432,000</b>
<b>Phase 1B Infrastructure</b>				
9.	15" Pipe	518 LF	\$110	\$57,000
10.	12" Pipe	3,028 LF	\$100	\$303,000
11.	10" Pipe	5,367 LF	\$90	\$484,000
12.	8" Pipe	17,228 LF	\$80	\$1,379,000
13.	Type "A" Case I Manhole	28 EA	\$9,000	\$252,000
Subtotal				\$2,475,000
Engineering Costs (20%)				\$495,000
Contingencies (20%)				\$594,000
<b>Subtotal Phase 1B Development Costs</b>				<b>\$3,564,000</b>
<b>Total Project Cost</b>				<b>\$12,000,000</b>

**Table 4.2 – Phase 2 Infrastructure Probable Cost**

Description		Quantity	Unit Cost (\$)	Total Cost (\$)
1.	12" Pipe	1,318 LF	\$100	\$132,000
2.	10" Pipe	971 LF	\$90	\$88,000
3.	8" Pipe	7,661 LF	\$80	\$613,000
4.	12" Force Main	7,870 LF	\$120	\$945,000
5.	Type "A" Case I Manhole	20 EA	\$9,000	\$180,000
Subtotal				\$1,958,000
Engineering Costs (20%)				\$392,000
Contingencies (20%)				\$470,000
<b>Total Project Cost</b>				<b>\$2,820,000</b>

**Table 4.3 – Phase 3 Infrastructure Probable Cost**

Description		Quantity	Unit Cost (\$)	Total Cost (\$)
1.	10" Pipe	3,037 LF	\$90	\$274,000
2.	8" Pipe	13,326 LF	\$80	\$1,067,000
3.	Type "A" Case I Manhole	33 EA	\$9,000	\$297,000
Subtotal				\$1,638,000
Engineering Costs (20%)				\$328,000
Contingencies (20%)				\$394,000
<b>Total Project Cost</b>				<b>\$2,360,000</b>

Connection fees were also estimated for each planning phase based on proposed building area square footages and typical sewer connection fees for commercial and industrial connections. Commercial connection fees were assumed to be \$2.11 per square-foot of building area and industrial connection fees were assumed to be \$2.49 per square-foot of building area. Based the preliminary evaluation of the service connection fees, the total estimated buildout connection cost is approximately \$30.6 million with connection costs for Phase 1A, Phase 1B, Phase 2, and Phase 3 being \$3.6, \$9.9, \$6.5, and \$10.7 million respectively (Table 4.4).

**Table 4.4 – Estimated Sanitary Sewer Connection Fee**

Description	Connection Fee (\$/SF)	Phase 1A Connection Cost (\$)	Phase 1B Connection Cost (\$)	Phase 2 Connection Cost (\$)	Phase 3 Connection Cost (\$)
Commercial Connection	2.11	\$2,000,000	\$5,700,000	\$3,400,000	\$5,100,000
Industrial Connection	2.49	\$1,600,000	\$4,200,000	\$3,100,000	\$5,600,000
Total Connection Cost by Phase =		\$3,600,000	\$9,900,000	\$6,500,000	\$10,700,000
<b>Total Buildout Connection Cost</b>					<b>\$30,600,000</b>

### **Phase 1A Interim Sanitary Sewer Infrastructure**

An interim solution prior to completion of the Phase 1A gravity trunk-line improvements is to construct and operate a temporary packaged wastewater treatment facility to treat and discharge waste from development in the Phase 1A area. Typical packaged plant systems can be designed for short term or long term use and utilize conventional wastewater treatment practices such as aeration, sedimentation, and filtration, to meet discharge standards. Additional cost-benefit analysis is needed to determine if a packaged treatment plant may be a suitable interim solution to complete buildout of the proposed Phase 1A improvements.

## 5.0 SYSTEM DESIGN CRITERIA

Section 5 discusses the system design criteria for the Project. Sewer service for the Project will consist of a gravity trunk main system as well as a lift station and force main facilities to convey flows to the existing Western Hills Water District 18-inch trunk line beneath Ward Ave west of the Project.

### 5.1 GRAVITY COLLECTION AND CONVEYANCE

Gravity collection and conveyance facilities will be sized for the design flow as defined and calculated in Section 3.

#### 5.1.1 Manning's Coefficient

A Manning's coefficient of roughness (n) of 0.013 is used in determining the require pipe sizes for the system. This value is conservative for capacity determination and is typically used in the design of new facilities.

#### 5.1.2 Flow Depth Criteria

Flow depth criteria is expressed as a maximum depth of flow to pipe diameter (d/D). Per the COM Wastewater Master Plan, new gravity sewer mains must be sized to convey design flows at 70 percent of pipe capacity.

#### 5.1.3 Design Velocity and Minimum Slope

Design criteria for gravity collection and conveyance facilities are typically established to keep velocities equal to or greater than 2 feet per second (fps) at full flow. Lower velocities increase the possibility of buildup in the sewer system. Pipes were sized from a capacity standpoint, and pipe velocities will need to be further evaluated for final design. The minimum pipe slope criteria used in this analysis to maintain acceptable pipe velocities are consistent with COM Standards. Typical published values for minimum pipe slope are listed in Table 5.1.

**Table 5.1 – Minimum Slope Criteria**

Pipe Diameter (Inches)	Minimum Slope (FT/FT)
8	0.0035
10	0.0025
12	0.0020
15	0.0012
18	0.0010
24	0.0007

## 5.2 LIFT STATIONS AND FORCE MAINS

Two lift stations are to be constructed as part of Phase 1A improvements. The first lift station is southwest of the Marshall Road and State Route 33 intersection will be designed to provide 50 percent standby capacity with a minimum of 2 pumps. The lift stations will be sized to handle peak sewer flows generated from the respective service areas. All pumps will have equal capacity and will utilize variable speed drive motors to minimize the wet well size. The lift station will be equipped with, at minimum, telemetry equipment capable of transmitting alarm conditions, standby-power generating equipment, and flow monitoring equipment. Compliance will be required with all applicable agency permitting and regulations for the design and operation of the facility, including, but not limited to, the State Regional Water Quality Control Board.

The sanitary sewer lift station and a force main from the lift station to the existing Western Hills Water District sewer trunk main in Ward Ave will be constructed as part of the initial phase of development. The force main will have sufficient capacity to convey wastewater flows from all areas to be developed and were sized in conjunction with the pumping facility. Project force main sizing was determined in accordance with the Hazen-Williams Equation. Force main sizing also considers maximum velocities in the pipe, as high velocities can cause scouring in the pipe and increase headloss. Typically, force mains are sized for a velocity range between 3 and 7 feet per second (fps). The force main will cross the Delta-Mendota Canal approximately 0.5 miles east of the Ward Ave/Marshall Road intersection.

A second lift station will also be constructed as part of the Phase 1A improvements south of the airfield near the Delta Mendota canal. Due to the depth of the canal structure a lift station will be required to convey peak sewer flows generated from the respective upstream service area. No force main piping is required.

## 6.0 SEWER COLLECTION AND SYSTEM LAYOUT

Section 6 discusses the required sewer system layout and sewer facilities needed to collect and convey sewer flows generated by the Project to the existing Western Hills Water District 18-inch trunk line beneath Ward Ave west of the Project discussed in Section 5. Additionally, this section discusses the phasing and implementation of the proposed sanitary sewer system and the future connection to the proposed South Patterson trunk line.

### 6.1 GRAVITY TRUNK LINES

Gravity trunk mains are sized based on criteria discussed in Section 5. Sewer flows generated by each service area described in Section 3.1 and shown in Figure 4.4 will be collected via gravity sewer trunk mains ranging in size from 8 inches in diameter to 18 inches in diameter. Trunk mains installed as part of the initial phases will have adequate capacity to convey flows from future phases of the Project. Figures 4.1-4.3 show the preliminary layout of the gravity sewer trunk main system for Phases 1, 2, and 3.

### 6.2 LIFT STATIONS AND FORCE MAINS

The lift station near the northeast corner of the development will be required to pump sewer flows generated from all areas of the Project. Based on the projected design flows for all phases of development combined, as discussed in Section 3, the required capacity of the lift station is approximately 2.66 MGD. A single 12-inch-diameter force main provides adequate velocities for Phases 1, 2, and 3 with approximate velocities of 2.50 fps, 3.59 fps, and 5.26 fps, respectively.

The sanitary sewer lift station south of airfield near the Delta Mendota Canal will be required to develop the required hydraulic profile for the Phase 1A system. Based on the project design flows discussed in Section 3, the required capacity of the lift station is approximately 0.32 MGD.

### 6.3 INFRASTRUCTURE IMPLEMENTATION PLAN SUMMARY

The City of Patterson's (COP) existing sanitary sewer infrastructure does not have sufficient capacity to meet the Crows Landing Industrial Business Park's (CLIBP) buildout sanitary sewer flows. Therefore, in order to successfully convey sewer flows from the CLIBP to the COP, AECOM and County staff developed an infrastructure implementation plan to convey sanitary sewer loads for each phase of the project to the COP's Wastewater Treatment Facility. A summary of the infrastructure plan is below.

Based on conversations with County staff, Western Hills Water District (WHWD), and City of Patterson, the available capacity in the existing Ward Ave trunk lines and the South Patterson trunk line were estimated and summarized in Table 6.1 below.

**Table 6.1 – Existing Available Pipe Capacity**

<b>Existing Sewer Facility</b>	<b>Owner</b>	<b>Existing (Yes/No)</b>	<b>Available Capacity (MGD)</b>
Ward Ave Trunk	WHWD	Yes	2.5 <sup>1</sup>
Ward Ave Trunk	COP	Yes	1.37
South Patterson Trunk Sewer (SPTS)	COP	No, expected in about 10 years	4.9 <sup>2</sup>

<sup>1</sup>This is the estimated available capacity in the Ward Ave. trunk link for the buildout of Diablo Grande. Based on document provided by WHWD, the total estimated sewer flow is around 1 MGD for buildout as shown in Appendix A in Table entitled, “Full Flow Pipeline Capacity for 18” Line Along Ward Ave”.

<sup>2</sup>Available capacity is for the worst case section of proposed SPTS based on COP buildout scenario loadings. Under buildout, the SPTS is designed for 0.50 d/D ratio. Available capacity shown brings d/D ratio to 0.8 which is considered full capacity, see Appendix A Table entitled, “South Patterson Trunk Sewer Capacity Analysis”

(Update: See the sewer capacity discussion in Section 7.0.)

Comparing the projected CLIBP sewer flows to the existing and anticipated available capacities of the COP trunk lines, the following infrastructure phasing plan for each phase of the CLIBP buildout is described as follows.

**Phase 1**

Phase 1A. The County proposes to convey the projected 0.32 MGD of PWWF CLIBP sewer flows from the Phase 1A development to the WHWD Ward trunk line down to the COP where it enters the COP Ward trunk line and flows to the COP wastewater treatment plant (WWTP).

Phase 1B. The County proposes to tie in to the Phase 1A Corridor sanitary sewer infrastructure to convey the projected 1.26 MGD of combined Phase 1A and Phase 1B PWWF CLIBP sewer flows to the WHWD Ward trunk.

**Phase 2**

The County proposes to build a force main system parallel to the WHWD Ward Ave trunk to convey sewage from the CLIBP to the COP at this juncture in time. The force main system should be able to convey at least 2.66 MGD for the peak wet weather flow scenario from the CLIBP 100% buildout. The proposed parallel force main will connect to the proposed South Patterson Trunk Sewer (SPTS). This new trunk line will be utilized to convey CLIBP-generated sewage to the COP WWTP. The County will assist in paying for the necessary STPS construction and any necessary improvements to expand the COP WWTP to accommodate the additional CLIBP sewer flows. The COP WWTP expansion should be sized to handle buildout peak wet weather flows from the CLIBP.

**Phase 3**

This phase will utilize the newly constructed parallel force main system in Ward Ave. to convey CLIBP sewer flows to the COP. The SPTS will carry buildout flows from the CLIBP to the expanded COP WWTP.

## Assumptions

The Project phasing assumes the following:

- WHWD will allow the CLIBP to utilize their portion of the available Ward Ave trunk line capacity. District Engineer Patrick Garvey has confirmed that WHWD has tentatively agreed to accommodate the CLIBP at this point. An agreement will be developed between the County and WHWD to capture costs associated with utilizing capacity in the Ward Ave. trunk line.
- The COP owns and operates the portion of the Ward Ave trunk line along Ward Ave from M Street to just south of Bartch Avenue extending to the limits of the Patterson Service Area as identified in the COP Master Plan. WHWD owns and operates the Ward Ave trunk line to the south of this limit to approximately Marshall Road.
- The available capacity of the Ward Ave. trunk owned by WHWD as calculated by WHWD is 3.6 MGD for a full pipe. Assuming a 0.8 d/D ratio, capacity is approximately 3.5 MGD.
- Diablo Grande will generate approximately 1 MGD of sewage flow at buildout. There are currently reports of little to no peaking flow in the trunk. It is uncertain if this lack of peaking flow will continue.
- The County will fund its fair share of the improvements needed in the COP sewer system due to impacts by the CLIBP through connection fees.
- The COP will build the improvements needed to accommodate the CLIBP.
- The COP will fix the known existing deficiency in the Ward trunk. The existing deficiency is at the intersection of Ward Ave and M Street. There is a pipe with reverse slope here that will need to be corrected.
- Inflow and infiltration should be very little for new sewer systems. While it is anticipated to be minimal for the CLIBP initially, it will still be present due to holes in manhole covers and leaking pipe joints, etc.
- The revised sewer loading factors and revised demands are confirmed and acceptable to the County.



## 7.0 SEWER TREATMENT, STORAGE, AND DISPOSAL

Section 7 discusses treatment and disposal of sewer flows generated by the Project. Information contained within the *City of Patterson Wastewater Master Plan, May 2010 Edition* was used to define treatment, storage, and disposal provided by the City of Patterson Water Quality Control Facility (WQCF).

Prior to the November 2017 update to this study, the COP completed an update to its Wastewater Master Plan (WWMP). That plan did not include wastewater contributions from CLIBP. The COP contracted with Blackwater Consulting Engineers, Inc. (Blackwater) to generate a Technical Memorandum (TM) as an update to their master plan, summarizing the potential impacts to Patterson's wastewater collection system and WQCF from CLIBP wastewater flows and loadings, including from Phase 1 to Buildout. This included a hydraulic model update of the City's sewer system and capacity analysis of the WQCF. A copy of this TM is included in Appendix C.

The County's preferred alternative is to construct sanitary sewer force mains in Marshall Road from the Project's lift station to a new connection on the existing Western Hills Water District sewer trunk line, which conveys sewer flows to the City of Patterson's sanitary sewer conveyance system for delivery to the City's WQCF. According to the City's current Wastewater Master Plan, the permitted capacity of 3.5 MGD does not account for development outside the City's 2004 sphere of influence. Additionally, the plant evaluation in Appendix C concluded that the WQCF's "reliable" capacity is less than the permitted capacity; therefore, a facility expansion would be required to handle Project wastewater flows. The timing of such expansion would need to be determined with the City of Patterson.

### 7.1 CITY OF PATTERSON WASTEWATER COLLECTION AND TREATMENT SYSTEMS

The COP WQCF receives wastewater from the trunk sewer system near the intersection of Walnut Ave and Poplar Ave. The wastewater enters an influent pumping station where it is screened and then pumped to several process units for treatment. The City is using three treatment processes including the South Activated Sludge Treatment System, the North Activated Sludge Treatment System, and the Advanced Integrated Pond System. These treatment systems use a combination of aeration, circulation, nitrogen removal, clarifiers, aerobic digesters, percolation ponds, and dewatering beds.

There are 15 percolation ponds for effluent disposal located in the WQCF plant site. The total area of these ponds is approximately 109 acres. Percolation capacity on an average annual basis is approximately 3.38 MGD.

#### 7.1.1 City of Patterson Wastewater Collection System

The Blackwater TM (Appendix C) contains the following findings and conclusions regarding acceptance of CLIBP wastewater flows into the COP wastewater collection systems.

- The original approach for disposing of the projected CLIBP sewer flows from the Phase 1A and Phase 1B developments was to discharge by gravity to the WHWD Ward trunk line down to the COP where it enters the COP Ward trunk line and flows to the COP WQCF. This pipeline route is shown in Figure 2.1 at the end of this document.

- Hydraulic analysis of the Ward Avenue trunk sewer showed it does not have sufficient capacity to accommodate the known areas in Patterson for potential growth, and the addition of CLIBP Phase 1 flows. To accommodate the CLIBP flows, the existing 21-inch sections would need to be upsized to 24-inches.
- Further downstream on the proposed COP route, hydraulic analysis confirmed a portion of the M Street sewer has a reverse slope, and is recommended for replacement.
- For CLIBP Phase 2, the County proposes to build a force main parallel to Ward Road, connecting to the proposed new SPTS discharging to the WQCF. This route is also shown in Figure 2.1. The Blackwater analysis confirmed this proposed conveyance has the capacity to accommodate the CLIBP Buildout PWWF.
- Construction of the SPTS system was recommended before accepting CLIBP flows up to their buildout ADWF. System would be built to accommodate full buildout flows from Diablo Grande, CLIBP and South Patterson. Probable construction cost was estimated at \$8.38M, equating to a cost-sharing unit cost of \$3.40 per gpd ADWF.
- Cost share to the County for accommodating the CLIBP full buildout flow in the City's collection system was estimated at \$3.03M.

#### 7.1.2 City of Patterson WQCF Treatment Capacity

The current total “reliable” capacity of the COP WQCF is estimated to be 1.85 MGD. Completion of the Phase III and Phase IV expansion projects described in the City's latest WWMP are needed to accept the full buildout flows from the CLIBP.

- The report in Appendix C provides line item estimates for the Phase IV expansion. Probable construction cost was estimated at \$8.38M, equating to a cost-sharing unit cost of \$30 per gpd ADWF. Cost share to the County for accommodating the CLIBP full buildout flow in the City's collection system and the WQCF was estimated at \$29.8M.

## 7.2 WASTEWATER TREATMENT AND DISPOSAL ALTERNATIVES

### 7.2.1 Individual On-Site Treatment and Disposal

If the City of Patterson cannot accommodate the projected wastewater flows from the Project, then the Stanislaus County's *Guidelines for Septic System Design* could be followed for development until the City can make provisions to accommodate additional sewer flows. This approach could be used for initial development of the Phase I areas, with new industrial facility owners or tenants responsible for the individual systems' design, construction and maintenance. The County could evaluate and approve individual systems on a case by case basis. Further studies would be required to determine the number and extent of individual systems that could be allowed until construction of Phase I sewer infrastructure should begin.

Such systems, referred to as Onsite Wastewater Treatment Systems (OWTS), are regulated under OWTS policy by the State Water Resources Control Board, as well as Stanislaus County. The range from traditional septic systems with leach fields to more advanced systems with biological filters to reduce BOD and TSS in the septic tank effluent. Some systems or components can also reduce nitrates. The

state OWTS policy categorizes these treatment systems within several tiers, with ascending tiers associated with fewer environmental risks. Stanislaus County guidelines require a biological treatment component for new septic systems. A commonly used OWTS biological filter module used to provide additional treatment to septic tank effluent is shown in Figure 7.1.



**Figure 7.1 – Septic Tank Effluent Biofilter (Orenco)**

This is one of several National Sanitation Foundation (NSF) approved OWTS components that provide higher levels of treatment than standard septic systems with leach fields. Biofilters of this type should be able to produce effluent with less than 30 mg/L BOD and less than 30 mg/L TSS or better. Components and options include the following.

- Filter feed pumps recirculate the septic tank effluent through fabric biofilters to reduce dissolved organic constituents.
- Effluent dosing pumps convey the treated effluent to irrigation systems and/or shallow soil percolation fields. Under state regulations, irrigation distribution systems that distribute effluent below the soil surface and do not result in any surface ponding can operate without disinfection of the treated effluent.

- Each OWTS is subject to siting regulations and restrictions, including soil type, percolation rates, depth to groundwater, and other limitations. The County would evaluate each system on a site-specific basis to determine if it can be approved.

The use of OWTS will have a greater impact on groundwater and will require: 1) referral to RWQCB for review for any systems that treat industrial waste, 2) monitoring more closely than other systems, 3) more land area designated for the disposal of the effluent (initial dispersal field 100% future expansion dispersal field) for each system, and 4) engineered design as they are commercial and industrial systems.

### 7.2.2 Phased Wastewater On-Site Treatment and Disposal

Packaged or custom wastewater treatment systems, complying with California Title 22 recycled water regulations and State Water Board wastewater discharge regulations, can be constructed on the CLIBP property to manage its wastewater over time.<sup>4</sup> Modular treatment systems can be matched to the treatment capacity required for each phase and constructed as needed, not unlike the phased expansion projects that the COP is planning with its WQCF.

A primary consideration in selecting an on-site treatment system is the reuse or disposal method selected for the treated effluent. Three effluent reuse and disposal assumptions were considered.

- 100 percent of treated effluent is reused for landscape irrigation with storage during the non-irrigation wet season.
- Treated effluent is reused for landscape irrigation to the extent practicable during the irrigation season with limited storage and percolation to manage effluent generated during the wet season.

Treated effluent is disposed of by percolation in the multi-use storm water retention pond described in the CLIBP Drainage Study.

A number of combinations may also be employed. For example, treated effluent could be used for irrigation during the irrigation season and discharge to the storm water retention pond during the non-irrigation season.

Water quality requirements for effluent disposal assumptions are presented in Table 7.1.

**Table 7.1 – Water Quality Requirements for Effluent Disposal Assumptions**

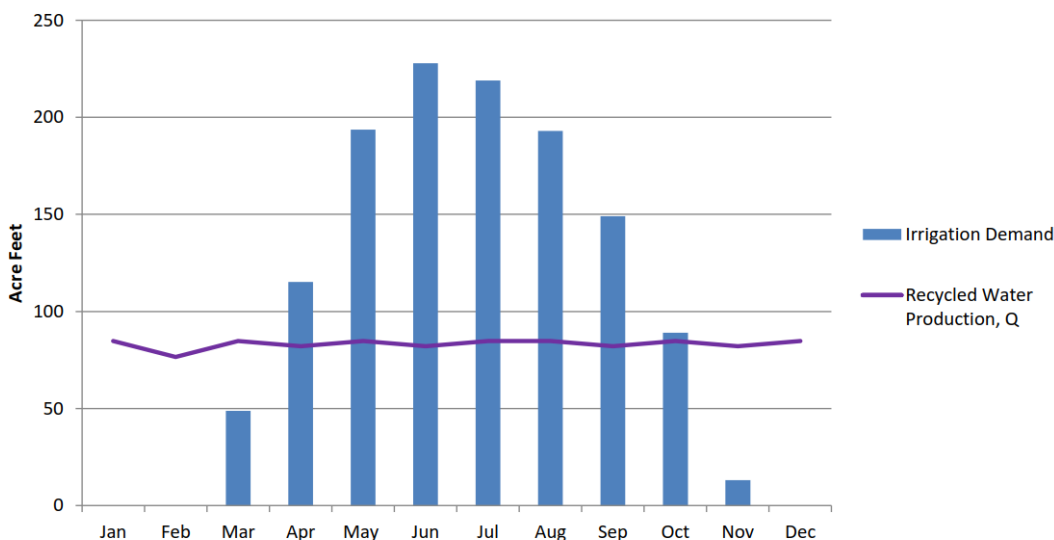
Constituent	Assumed Effluent for Reuse	Assumed Effluent for Surface Discharge	California Title 22
BOD <sub>5</sub>	< 10 mg/L	< 5 mg/L	
TSS	< 10 mg/L	< 5 mg/L	
Total Nitrogen	< 10 mg/L	< 2 mg/L	
Turbidity			< 2 NTU
Fecal Coliform			< 2.2 MPN/100 ml

<sup>4</sup> A package treatment system may also require submittal of Waste Discharge Requirements (WDR) to the RWQCB.

A 12-month water balance was calculated to determine irrigation demands and how much irrigated land and water storage would be required for the 100 percent effluent irrigation option. This balance was calculated only for the total buildout phase using the ADWF of 0.891 MGD to establish the feasibility of this assumption. The parameters used in the water balance, including evapotranspiration and precipitation data along with their sources, are summarized in Appendix D.

Figure 7.2 shows a graphical representation of the monthly irrigation demand overlaid by the full buildout ADWF effluent flow from the proposed on-site treatment plant that would be available for irrigation. Several balances were run with different sized land areas. The results shown in Figure 7.2 were derived from running a balance on about 250 irrigated acres.

**Comparison of Average Monthly CLIBP Irrigation Water Demand and Recycled Water Production Rates.**



**Figure 7.2 – Water Balance Graph for 250 Irrigated Acres**

As can be seen in the figure, irrigation demand in the dry season from April through October significantly exceeds the recycled water that would be available at full buildout. During wet season months from November through March, recycled water generation exceeds irrigation demand which falls to zero in the months of December, January, and February. To achieve a 100 percent irrigation disposal scenario, the effluent would have to be stored in a reservoir through these non-irrigation periods and be available for the greater irrigation demand months in addition to the recycled water generated in those months. However, reservoir capacity needed for this storage would require setting aside more land than is likely to be available. Furthermore this reservoir would have to be set back from the airport runway as described in the CLIBP Drainage Study. Owing to these restrictions, the 100 percent irrigation disposal assumption is not being considered.

The other assumptions, irrigation as practicable with percolation, or call percolation discharging to the storm water retention pond, remain viable options for disposing of treated wastewater from the CLIBP.

To compare an on-site wastewater treatment system to the option of disposal at the Patterson WQCF, an assessment was made of treatment systems for the full buildout wastewater ADWF. Two types of modular, packaged treatment systems were considered. These are described below.

### Sequencing Batch Reactor (SBR)

SBRs will have been successfully utilized for decades in the United States. The process consists generally of two or more activated sludge reactors/basins, which operate with alternate filling, reacting, settling, and decanting over a specified time. The alternating sequences of the activated sludge basins allow for continuous flow into an out of the treatment plant in spite of its “batch” operation. The SBR combines BOD reduction, nitrification and denitrification, and clarification into each reactor. Pretreatment includes screening and grit removal of the raw influent. Generally there is no primary settling. Nearly suspended solids and dissolved organics are treated in the activated sludge reactors which produce clarified effluent and waste activated sludge (WAS). The decanted clarified effluent is further treated by tertiary filters to achieve the turbidity requirements of California Title 22 recycled water regulations. The fecal coliform requirements are achieved with ultraviolet (UV) disinfection.

Waste products requiring off-site disposal would include the screenings and grit, both washed, mechanically dewatered and compacted, and the WAS. The WAS is stabilized in an aerobic digester reactor that is part of the packaged plant. Stabilized WAS is then mechanically dewatered, typically with a centrifuge or screw press. A contracted waste hauler will periodically remove these byproducts for off-site disposal at a permitted facility.

The amount of land needed for an SBR and its support infrastructure should be less than 10 acres. This would include a small emergency storage reservoir that can store from 1 to 3 days of effluent should it fall out of compliance with Title 22 or state discharge permit limitations. This is a regulatory requirement. A properly operated SBR with tertiary filtration and UV disinfection should be able to comfortably meet the effluent limitations presented in Table 7.1.

### Membrane Bioreactor (MBR) Process

MBRs have become very popular for high effluent quality. They are similar to SBRs in that all biological processes happen in a common reactor basin. The MBR also combines microfiltration within the reactor or in a side chamber, eliminating the need for a settling/clarification step. MBRs can achieve non-detect results for BOD and TSS, and < 0.01 NTU turbidity. If nitrogen removal is included, total nitrogen in the effluent will be typically < 5 mg/L. The preliminary treatment processes, tertiary filtration and disinfection, and WAS digestion on dewatering processes would be the same as those described for the SBR. MBRs typically use more energy than comparable SBRs, but are reported to be somewhat easier to operate. Both MBRs and will SBRs are ideal for modular phased construction, adding capacity when it is needed.

The unit costs assumed for construction cost opinions for these processes range as follows.

- SBR: \$25-\$30 per gpd ADWF
- MBR: \$27-\$32 per gpd ADWF

Assuming full capacity build out facilities were constructed, the construction cost opinions would average \$24.5M for the SBR process, and \$26.3M for the MBR process. Building either process in phases to match the capacities needed for each development phase would cost more in current dollars, but less

and life cycle or present worth dollars. Phased construction is the normal method in most projects of this type.

### 7.2.3 Permitting and Operations for On-Site Treatment and Disposal

#### Individual OWTS

For initial developments with OWTS for individual facilities, the County has permitting authority and mechanisms available to evaluate, approve and permit such systems. State criteria are mostly siting based and the County would remain the lead agency as long as treated effluent cannot percolate into groundwater or migrate into surface waters.

#### Irrigation and Percolation Assumption

Under this treatment and disposal assumption, highly treated effluent is discharged to land with no discharge to surface waters, but discharge will reach groundwater. Under this scenario, the treatment plant owner must obtain a waste discharge requirements (WDR) permit from the State Water Board. The Regional Water Board will be the lead agency, but the County will also be involved. The Regional Water Board will write WDRs that include effluent limitations designed to protect groundwater quality.

#### Discharge into Storm Water Pond with Percolation Assumption

Under this treatment and disposal assumption, highly treated effluent is discharged into the proposed multi-use storm water pond where the effluent will percolate into the upper unconfined groundwater aquifer. During storm events, effluent would blend with storm water in the pond, which will be designed with a specially engineered bottom to enhance percolation in the otherwise slow percolating soil in that area. This is explained in the CLIBP Drainage Study.

- The proposed storm water pond is to be designed to contain all storm water runoff up to a 2-year storm event. This 40 acre pond is shown on Figure 1.1.
- In the event that a storm event greater than the 2-year storm occurs, the pond could overflow at its north end with the overflow eventually making its way to the San Joaquin River. Although any of the treated effluent in the pond would be a small portion of this overflow, the state Regional Water Board would consider this a surface water discharge. The County would be required to get an NPDES discharge permit in addition to state WDRs. The NPDES permit would likely have seasonal flow limitations, allowing discharge from the Storm Water Pond only during the wet season.
- Permitting either of the above alternatives may have complications due to currently unknown site conditions. Limitations on dissolved mineral parameters such as total dissolved solids (TDS) and electro conductivity (EC) can be difficult to resolve for either land/groundwater or surface water discharges. If residuals from wellhead treatment are discharged to the sewer system, this could exacerbate the TDS or EC problems.

## 8.0 OVERALL FINDINGS

The following conclusions are made based on the findings of this study.

- Wastewater flows generated by the Project and pumped into the existing trunk main within Ward Ave will require treatment, storage, and disposal.
- The Project area will be annexed into the Western Hills Water District for sanitary sewer conveyance and treatment. Eventually the Phase 2 and 3 buildout will require coordination with the City of Patterson to connect to the proposed South Patterson trunk line.
- The existing agreement between the City of Patterson and the Western Hills Water District to convey, treat, and dispose of wastewater will require amendment to accommodate Project flows.
- The City of Patterson Water Quality Control Facility will require improvements to accommodate the addition of Project flows. Additional studies are required to determine the improvements required at the facility to handle Project flows.
- The projected peak wet weather flows at build-out of the Project total approximately 2.66 MGD.
- The projected peak wet weather flows for Phase 1A development total approximately 0.32 MGD
- The projected peak wet weather flows for Phase 1 of the Project total approximately 1.26 MGD.
- The Project will consist of two sewer collection system service areas.
- The lift station located near Marshall Road is required to convey sewer flows from the Project to the existing Western Hills Water District 18-inch sanitary sewer trunk main beneath Ward Ave. The lift station is to be sized to convey the estimated peak sewer flows of 2.66 MGD for the anticipated buildout of the development. The lift station located south of the air field near the Delta Mendota Canal is required to maintain the hydraulic profile in the system after traveling under the 20- to 30-foot-deep canal structure. The lift station is to be sized for approximately 0.32 MGD, which will deliver approximately 4 feet of head to downstream invert.
- OWTS for individual sewer connections may be feasible, subject to percolation test data, in the initial development stages of Phase 1, transitioning to a community collection system at a point to be determined.
- Phased on-site community wastewater treatment and disposal facilities that discharge highly treated effluent to landscape irrigation and/or percolation are a feasible alternative to sending wastewater to the City of Patterson. On-site community wastewater treatment and disposal facilities will require engineered design, and percolation test data will be necessary to determine feasibility and the amount of land required for waste water discharge/disposal.

### 8.1 ALTERNATIVES

A stand-alone onsite wastewater treatment and disposal system facility is feasible, but the County prefers a regional solution with the City of Patterson to better serve the Project and its community



stakeholders. An on-site treatment solution would require implementation of a local disposal or re-use solution for treated effluent in addition to a plan for solids removal or re-use. An advantage to the regional solution with the City of Patterson is that their collection and treatment system is already permitted.

**Appendix A**  
**Sewer Calculations**

---

South Patterson Trunk Sewer Remaining Capacity Analysis\

Crows Landing Industrial Business Park Sewer System (Sanitary Sewer) Infrastructure Study)

Stanislaus County

Label <sup>1</sup>	Diameter		Slope (Calculated)			Flow at 0.7		Remaining Capacity		Available Capacity (Y/N)
	(in) <sup>1</sup>	Length (Unified) (ft) <sup>1</sup>	(ft/ft) <sup>1</sup>	Flow (gal/day) <sup>1</sup>	d/D (%) <sup>1</sup>	d/D <sup>2</sup>	Flow (MGD)	Assuming Max d/D of 0.7 (MGD)		
S1	24	1,280	0.0041	4,232,539	47.2	7.83	4.2	3.6	Yes	
S2	24	1,353	0.0044	4,521,867	48.0	8.11	4.5	3.6	Yes	
S3	30	1,927	0.0017	4,836,249	46.6	9.15	4.8	4.3	Yes	
S4	30	2,076	0.0018	4,932,013	46.3	9.41	4.9	4.5	Yes	
S5	30	353	0.0020	5,379,426	47.2	9.92	5.4	4.5	Yes	
S6	30	1,627	0.0042	5,379,426	38.4	14.38	5.4	9.0	Yes	
S7	33	2,653	0.0012	5,465,825	47.7	9.91	5.5	4.4	Yes	
S8	33	3,947	0.0022	6,542,925	44.5	13.42	6.5	6.9	Yes	
S9	36	2,586	0.0015	6,684,588	44.0	13.97	6.7	7.3	Yes	
Buildout Peak Wet Weather Flow of CLIBP			2.66	MGD						

<sup>1</sup>Design data provided by NV5.

<sup>2</sup>Assumes manning's n of 0.013. Calculation was performed using <http://hawsedc.com/engcalcs/Manning-Pipe-Flow.php> accessed 2/11/16

Full Flow Pipeline Capacity for 18" Line along Ward Ave  
 Crows Landing Industrial Business Park Sewer System (Sanitary Sewer) Infrastructure Study  
 Stanislaus County

Mannings Equation  $Q = \left(\frac{1.49}{n}\right) AR^{2/3} \sqrt{S}$

n = 0.011  
 S = 0.002  
 d = 18 in  
     1.5 ft  
 A = 1.77 ft<sup>2</sup>  
 R = 0.375

Source:  
[http://www.jmeagle.com/pdfs/2008%20Brochures/Gravity%20Sewer\\_web.pdf](http://www.jmeagle.com/pdfs/2008%20Brochures/Gravity%20Sewer_web.pdf)

From WHWD  
 Q = 5.564 cfs  
     3,595,857 gpd  
     3.60 MGD

Capacity

Diablo Grande	
Units (#)	Usage (gpd)
450	45,000
1000	100,000
2300	230,000
Full Permitted Flow	1,000,000
*Usage Ratio	100

Crows Landing		
	Dry (gpd)	Wet (gpd)
Phase 1	1,184,000	1,265,000
Phase 2	531,000	549,000
Phase 3	822,000	849,400
Phase 1+2	1,715,000	1,814,000
Phase 1+2+3	2,537,000	2,663,400

Scenario Analysis

Total Capacity Analysis										
Crows Landing Buildout Scenarios (Ward Ave Pipe Capacity 3.5 MGD assumes max d/D is 0.8)										
		Phase 1			Phase 1+2			Phase 1+2+3		
		Dry (gpd)	Wet (gpd)	Capacity (Y/N)	Dry (gpd)	Wet (gpd)	Capacity (Y/N)	Dry (gpd)	Wet (gpd)	Capacity (Y/N)
Diablo Buildout Scenarios	w/ Current Units	1,229,000	1,310,000	Y	1,760,000	1,859,000	Y	2,582,000	2,708,400	Y
	w/ 1000 Units	1,284,000	1,365,000	Y	1,815,000	1,914,000	Y	2,637,000	2,763,400	Y
	w/ 2300 Units	1,414,000	1,495,000	Y	1,945,000	2,044,000	Y	2,767,000	2,893,400	Y
	Full Permitted Flow	2,184,000	2,265,000	Y	2,715,000	2,814,000	Y	3,537,000	3,663,400	N

## Appendix B Model Output

---

**Scenario: Phase 1 - Peak**  
**Current Time Step: 0.000Hr**  
**FlexTable: Conduit Table**

Label	Start Node	Invert (Start) (ft)	Stop Node	Invert (Stop) (ft)	Manning's n	Diameter (in)	Length (ft)	Slope (ft/ft)	Flow (cfs)	Capacity (Full Flow) (cfs)	Velocity (Minimum) (ft/s)	Velocity (Maximum) (ft/s)	Velocity (Average) (ft/s)	Depth (Normal) / Rise (%)
CO-13	MH-08	118.92	MH-11	111.50	0.013	18.0	3,711.0	0.0020	1.99	4.70	2.00	15.00	2.55	45.8
CO-18	MH-07A	119.70	MH-08	118.92	0.013	15.0	518.0	0.0015	0.41	2.51	2.00	15.00	1.51	27.4
CO-20	MH-42	140.70	MH-45	128.00	0.013	8.0	3,195.0	0.0040	(N/A)	0.76	2.00	15.00	(N/A)	(N/A)
CO-22	MH-21	157.34	MH-41	151.85	0.013	8.0	1,569.0	0.0035	0.04	0.71	2.00	15.00	1.10	15.8
CO-23	MH-41	151.85	MH-40	147.01	0.013	8.0	1,384.0	0.0035	0.29	0.71	2.00	15.00	1.95	44.8
CO-25	MH-03	125.72	MH-7B	124.42	0.013	8.0	864.0	0.0015	0.13	0.47	2.00	15.00	1.14	35.8
CO-26	MH-7B	124.42	MH-07A	119.70	0.013	10.0	3,151.0	0.0015	0.38	0.85	2.00	15.00	1.51	47.0
CO-27	MH-002	131.36	MH-001	130.06	0.013	8.0	371.0	0.0035	0.17	0.72	2.00	15.00	1.67	32.8
CO-28	MH-001	130.06	MH-7B	124.42	0.013	8.0	1,611.0	0.0035	0.24	0.71	2.00	15.00	1.85	40.8
CO-29	MH-37	165.03	MH-41	153.23	0.013	8.0	1,902.0	0.0062	0.04	0.95	2.00	15.00	1.35	13.8
CO-30	MH-30	169.93	MH-29	166.79	0.013	8.0	897.0	0.0035	0.03	0.71	2.00	15.00	0.97	13.1
CO-31	MH-29	163.39	MH-36	158.78	0.013	8.0	1,316.0	0.0035	0.10	0.72	2.00	15.00	1.45	25.8
CO-32	MH-36	155.68	MH-40	153.53	0.013	8.0	716.0	0.0030	0.20	0.66	2.00	15.00	1.66	37.4
CO-34	MH-17	165.50	MH-35	162.43	0.013	8.0	1,025.0	0.0030	0.18	0.66	2.00	15.00	1.61	35.8
CO-35	MH-40	147.01	MH-35	142.61	0.013	10.0	2,201.0	0.0020	0.70	0.98	2.00	15.00	1.95	62.8
CO-36	MH-31	169.43	MH-17	167.14	0.013	8.0	654.0	0.0035	0.03	0.72	2.00	15.00	1.00	13.8
CO-37	MH-38	169.60	MH-33	164.69	0.013	8.0	1,403.0	0.0035	0.04	0.71	2.00	15.00	1.14	17.0
CO-38	MH-33	164.69	MH-34B	159.65	0.013	8.0	1,677.0	0.0030	0.19	0.66	2.00	15.00	1.65	37.4
CO-41	MH-39	169.21	MH-32	163.68	0.013	8.0	1,581.0	0.0035	0.04	0.71	2.00	15.00	1.14	16.8
CO-42	MH-32	163.68	MH-26	154.44	0.013	12.0	674.0	0.0137	0.07	4.17	2.00	15.00	2.02	9.2
CO-43	MH-34B	157.88	MH-26	154.44	0.013	8.0	981.0	0.0035	0.26	0.72	2.00	15.00	1.90	42.1
CO-45	MH-16	170.00	MH-48	164.50	0.013	8.0	154.0	0.0357	0.07	2.28	2.00	15.00	2.93	11.8
CO-47	MH-48	164.50	MH-49	162.30	0.013	8.0	529.0	0.0042	0.07	0.78	2.00	15.00	1.37	20.0
CO-49	MH-49	162.30	W-1	162.30	0.013	8.0	2.0	0.0000	0.07	0.00	2.00	15.00	0.20	(N/A)
CO-51	MH-34A	136.63	MH-08	118.92	0.013	18.0	6,795.0	0.0026	1.58	5.36	2.00	15.00	2.64	37.4
CO-52	MH-26	154.44	MH-34A	136.63	0.013	12.0	2,353.0	0.0076	0.36	3.10	2.00	15.00	2.63	22.8
CO-54	T-2	167.58	MH-17	165.83	0.013	8.0	738.0	0.0024	0.10	0.59	2.00	15.00	1.27	28.8
CO-55	MH-35	142.61	MH-51	138.48	0.013	12.0	2,066.4	0.0020	1.09	1.59	2.00	15.00	2.18	60.8
CO-56	MH-51	138.48	MH-34A	136.63	0.013	12.0	925.8	0.0020	1.09	1.59	2.00	15.00	2.18	60.8

K:\Projects\Crows Landing\Sewer Model\SewerCAD\VAECOM SSWR-MODEL-Rev 1.swc

**Scenario: Phase 1 - Peak**  
**Current Time Step: 0.000Hr**  
**FlexTable: Manhole Table**

Label	Elevation (Rim) (ft)	Elevation (Invert) (ft)	Flow (Total Out) (cfs)	Hydraulic Grade Line (In) (ft)	Hydraulic Grade Line (Out) (ft)	Headloss (ft)	Is Active?	Sanitary Loads	Sanitary Loads <Count>
MH-40	156.86	147.01	0.70	147.53	147.53	0.00	True	<Collection: 1 item>	1
MH-08	129.00	118.92	1.99	119.60	119.60	0.00	True	<Collection: 0 items>	0
MH-002	134.53	131.36	0.17	131.58	131.58	0.00	True	<Collection: 1 item>	1
MH-001	133.23	130.06	0.24	130.33	130.33	0.00	True	<Collection: 1 item>	1
MH-03	145.00	125.72	0.13	125.96	125.96	0.00	True	<Collection: 1 item>	1
MH-21	162.00	157.34	0.04	157.45	157.45	0.00	True	<Collection: 1 item>	1
MH-37	168.20	165.03	0.04	165.12	165.12	0.00	True	<Collection: 1 item>	1
MH-51	161.32	138.48	1.09	139.09	139.09	0.00	True	<Collection: 0 items>	0
MH-36	161.95	155.68	0.20	155.93	155.93	0.00	True	<Collection: 1 item>	1
MH-29	169.96	166.79	0.10	163.56	163.56	0.00	True	<Collection: 1 item>	1
MH-30	173.10	169.93	0.03	170.02	170.02	0.00	True	<Collection: 1 item>	1
MH-31	172.60	169.43	0.03	169.52	169.52	0.00	True	<Collection: 1 item>	1
MH-17	171.00	165.83	0.18	165.74	165.74	0.00	True	<Collection: 1 item>	1
MH-16	182.00	170.00	0.07	170.12	170.12	0.00	True	<Collection: 1 item>	1
MH-07A	130.00	119.70	0.41	120.04	120.04	0.00	True	<Collection: 1 item>	1
MH-49	175.00	162.30	0.07	163.80	163.80	0.00	True	<Collection: 0 items>	0
MH-41	155.02	151.85	0.29	152.15	152.15	0.00	True	<Collection: 1 item>	1
MH-35	165.00	142.61	1.09	143.22	143.22	0.00	True	<Collection: 1 item>	1
MH-48	178.00	164.50	0.07	164.63	164.63	0.00	True	<Collection: 0 items>	0
MH-7B	143.00	124.42	0.38	124.81	124.81	0.00	True	<Collection: 1 item>	1
MH-26	165.00	154.44	0.36	154.69	154.69	0.00	True	<Collection: 1 item>	1
MH-32	166.85	163.68	0.07	163.79	163.79	0.00	True	<Collection: 1 item>	1
MH-39	172.38	169.21	0.04	169.32	169.32	0.00	True	<Collection: 1 item>	1
MH-34A	159.67	136.63	1.58	137.19	137.19	0.00	True	<Collection: 1 item>	1
MH-34B	161.05	157.88	0.26	158.16	158.16	0.00	True	<Collection: 1 item>	1
MH-33	167.86	164.69	0.19	164.94	164.94	0.00	True	<Collection: 1 item>	1
MH-38	172.77	169.60	0.04	169.71	169.71	0.00	True	<Collection: 1 item>	1
MH-11	118.00	110.06	1.99	110.59	110.59	0.00	True	<Collection: 0 items>	0

K:\Projects\Crows Landing\Sewer Model\SewerCAD\AECOM SSWR-MODEL-Rev 1.swc

**Scenario: Phase 1,2 - Peak  
Current Time Step: 0.000Hr  
FlexTable: Conduit Table**

Label	Start Node	Invert (Start) (ft)	Stop Node	Invert (Stop) (ft)	Manning's n	Diameter (in)	Length (ft)	Slope (ft/ft)	Flow (cfs)	Capacity (Full Flow) (cfs)	Velocity (Minimum) (ft/s)	Velocity (Maximum) (ft/s)	Velocity (Average) (ft/s)	Depth (Normal) / Rise (%)
CO-4	MH-13	117.22	MH-12	114.32	0.013	8.0	966.0	0.0030	0.01	0.66	2.00	15.00	0.72	9.1
CO-6	MH-14	121.93	MH-13	120.08	0.013	8.0	527.0	0.0035	0.00	0.72	2.00	15.00	0.52	4.5
CO-13	MH-08	118.92	MH-11	111.50	0.013	18.0	3,711.0	0.0020	2.73	4.70	2.00	15.00	2.76	54.8
CO-14	MH-12	112.70	MH-11	110.06	0.013	12.0	1,318.0	0.0020	0.05	1.59	2.00	15.00	0.90	11.7
CO-15	MH-43	140.50	MH-44	131.71	0.013	8.0	1,953.0	0.0045	0.28	0.81	2.00	15.00	2.10	40.4
CO-16	MH-44	131.71	MH-45	128.65	0.013	8.0	1,020.0	0.0030	0.44	0.66	2.00	15.00	2.03	59.8
CO-17	MH-45	128.65	MH-07A	124.77	0.013	10.0	971.0	0.0040	0.73	1.38	2.00	15.00	2.57	51.4
CO-18	MH-07A	119.70	MH-08	118.92	0.013	15.0	518.0	0.0015	1.29	2.51	2.00	15.00	2.06	50.5
CO-20	MH-42	140.70	MH-45	128.00	0.013	8.0	3,195.0	0.0040	0.20	0.76	2.00	15.00	1.84	35.1
CO-22	MH-21	157.34	MH-41	151.85	0.013	8.0	1,569.0	0.0035	0.13	0.71	2.00	15.00	1.56	28.8
CO-23	MH-41	151.85	MH-40	147.01	0.013	8.0	1,384.0	0.0035	0.35	0.71	2.00	15.00	2.03	49.1
CO-25	MH-03	125.72	MH-7B	124.42	0.013	8.0	864.0	0.0015	0.12	0.47	2.00	15.00	1.13	34.8
CO-26	MH-7B	124.42	MH-07A	119.70	0.013	10.0	3,151.0	0.0015	0.42	0.85	2.00	15.00	1.56	50.0
CO-27	MH-002	131.36	MH-001	130.06	0.013	8.0	371.0	0.0035	0.16	0.72	2.00	15.00	1.64	31.5
CO-28	MH-001	130.06	MH-7B	124.42	0.013	8.0	1,611.0	0.0035	0.25	0.71	2.00	15.00	1.86	40.4
CO-29	MH-37	165.03	MH-41	153.23	0.013	8.0	1,902.0	0.0062	0.03	0.95	2.00	15.00	1.26	12.4
CO-30	MH-30	169.93	MH-29	166.79	0.013	8.0	897.0	0.0035	0.03	0.71	2.00	15.00	0.97	12.5
CO-31	MH-29	163.39	MH-36	158.78	0.013	8.0	1,316.0	0.0035	0.08	0.72	2.00	15.00	1.38	23.2
CO-32	MH-36	155.68	MH-40	153.53	0.013	8.0	716.0	0.0030	0.16	0.66	2.00	15.00	1.56	33.4
CO-34	MH-17	165.50	MH-35	162.43	0.013	8.0	1,025.0	0.0030	0.17	0.66	2.00	15.00	1.59	34.5
CO-35	MH-40	147.01	MH-35	142.61	0.013	10.0	2,201.0	0.0020	0.66	0.98	2.00	15.00	1.93	60.2
CO-36	MH-31	169.43	MH-17	167.14	0.013	8.0	654.0	0.0035	0.03	0.72	2.00	15.00	1.03	14.4
CO-37	MH-38	169.60	MH-33	164.69	0.013	8.0	1,403.0	0.0035	0.03	0.71	2.00	15.00	1.06	15.0
CO-38	MH-33	164.69	MH-34B	159.65	0.013	8.0	1,677.0	0.0030	0.15	0.66	2.00	15.00	1.54	32.8
CO-41	MH-39	169.21	MH-32	163.68	0.013	8.0	1,581.0	0.0035	0.05	0.71	2.00	15.00	1.18	18.0
CO-42	MH-32	163.68	MH-26	154.44	0.013	12.0	674.0	0.0137	0.08	4.17	2.00	15.00	2.04	9.4
CO-43	MH-34B	157.88	MH-26	154.44	0.013	8.0	981.0	0.0035	0.21	0.72	2.00	15.00	1.77	36.8
CO-45	MH-16	170.00	MH-48	164.50	0.013	8.0	154.0	0.0057	0.09	2.28	2.00	15.00	3.14	13.3
CO-47	MH-48	164.50	MH-49	162.30	0.013	8.0	529.0	0.0042	0.09	0.78	2.00	15.00	1.47	22.8
CO-49	MH-49	162.30	W-1	162.30	0.013	8.0	2.0	0.0000	0.09	0.00	2.00	15.00	0.25	(N/A)
CO-51	MH-34A	136.63	MH-08	118.92	0.013	18.0	6,795.0	0.0026	1.41	5.36	2.00	15.00	2.56	35.0
CO-52	MH-26	154.44	MH-34A	136.63	0.013	12.0	2,353.0	0.0076	0.30	3.10	2.00	15.00	2.50	21.0
CO-54	T-2	167.58	MH-17	165.83	0.013	8.0	738.0	0.0024	0.10	0.59	2.00	15.00	1.27	28.8
CO-55	MH-35	142.61	MH-51	138.48	0.013	12.0	2,066.4	0.0020	1.00	1.59	2.00	15.00	2.14	57.8
CO-56	MH-51	138.48	MH-34A	136.63	0.013	12.0	925.8	0.0020	1.00	1.59	2.00	15.00	2.14	57.8

K:\Projects\Crows Landing\Sewer Model\SewerCAD\AECOM SSWR-MODEL-Rev 1.swc



**Scenario: Phase 1,2 - Peak**  
**Current Time Step: 0.000Hr**  
**FlexTable: Manhole Table**

Label	Elevation (Rim) (ft)	Elevation (Invert) (ft)	Flow (Total Out) (cfs)	Hydraulic Grade Line (In) (ft)	Hydraulic Grade Line (Out) (ft)	Headloss (ft)	Is Active?	Sanitary Loads	Sanitary Loads <Count>
MH-42	143.87	140.70	0.20	140.93	140.93	0.00	True	<Collection: 1 item>	1
MH-29	169.96	166.79	0.08	163.54	163.54	0.00	True	<Collection: 1 item>	1
MH-36	161.95	155.68	0.16	155.90	155.90	0.00	True	<Collection: 1 item>	1
MH-51	161.32	138.48	1.00	139.06	139.06	0.00	True	<Collection: 0 items>	0
MH-37	168.20	165.03	0.03	165.11	165.11	0.00	True	<Collection: 1 item>	1
MH-21	162.00	157.34	0.13	157.53	157.53	0.00	True	<Collection: 1 item>	1
MH-03	145.00	125.72	0.12	125.95	125.95	0.00	True	<Collection: 1 item>	1
MH-30	173.10	169.93	0.03	170.02	170.02	0.00	True	<Collection: 1 item>	1
MH-002	134.53	131.36	0.16	131.57	131.57	0.00	True	<Collection: 1 item>	1
MH-40	156.86	147.01	0.66	147.51	147.51	0.00	True	<Collection: 1 item>	1
MH-43	143.67	140.50	0.28	140.77	140.77	0.00	True	<Collection: 1 item>	1
MH-45	131.17	128.00	0.73	129.08	129.08	0.00	True	<Collection: 1 item>	1
MH-44	134.88	131.71	0.44	132.11	132.11	0.00	True	<Collection: 1 item>	1
MH-08	129.00	118.92	2.73	119.74	119.74	0.00	True	<Collection: 1 item>	1
MH-14	128.00	121.93	0.00	121.96	121.96	0.00	True	<Collection: 1 item>	1
MH-12	121.00	112.70	0.05	112.82	112.82	0.00	True	<Collection: 1 item>	1
MH-13	128.00	117.22	0.01	117.28	117.28	0.00	True	<Collection: 1 item>	1
MH-001	133.23	130.06	0.25	130.33	130.33	0.00	True	<Collection: 1 item>	1
MH-07A	130.00	119.70	1.29	120.34	120.34	0.00	True	<Collection: 1 item>	1
MH-49	175.00	162.30	0.09	163.80	163.80	0.00	True	<Collection: 0 items>	0
MH-48	178.00	164.50	0.09	164.65	164.65	0.00	True	<Collection: 0 items>	0
MH-11	118.00	110.06	2.82	110.70	110.70	0.00	True	<Collection: 1 item>	1
MH-41	155.02	151.85	0.35	152.18	152.18	0.00	True	<Collection: 1 item>	1
MH-7B	143.00	124.42	0.42	124.84	124.84	0.00	True	<Collection: 1 item>	1
MH-31	172.60	169.43	0.03	169.53	169.53	0.00	True	<Collection: 1 item>	1
MH-26	165.00	154.44	0.30	154.67	154.67	0.00	True	<Collection: 1 item>	1
MH-32	166.85	163.68	0.08	163.79	163.79	0.00	True	<Collection: 1 item>	1
MH-34A	159.67	136.63	1.41	137.15	137.15	0.00	True	<Collection: 1 item>	1
MH-34B	161.05	157.88	0.21	158.13	158.13	0.00	True	<Collection: 1 item>	1
MH-33	167.86	164.69	0.15	164.91	164.91	0.00	True	<Collection: 1 item>	1
MH-38	172.77	169.60	0.03	169.70	169.70	0.00	True	<Collection: 1 item>	1
MH-17	171.00	165.83	0.17	165.73	165.73	0.00	True	<Collection: 1 item>	1
MH-39	172.38	169.21	0.05	169.33	169.33	0.00	True	<Collection: 1 item>	1
MH-16	182.00	170.00	0.09	170.13	170.13	0.00	True	<Collection: 1 item>	1
MH-35	165.00	142.61	1.00	143.18	143.18	0.00	True	<Collection: 1 item>	1

K:\Projects\Crows Landing\Sewer Model\SewerCAD\AECOM SSWR-MODEL-Rev 1.swc

**Scenario: Phase 1,2,3 - Peak**  
**Current Time Step: 0.000Hr**  
**FlexTable: Conduit Table**

Label	Start Node	Invert (Start) (ft)	Stop Node	Invert (Stop) (ft)	Manning's n	Diameter (in)	Length (ft)	Slope (ft/ft)	Flow (cfs)	Capacity (Full Flow) (cfs)	Velocity (Minimum) (ft/s)	Velocity (Maximum) (ft/s)	Velocity (Average) (ft/s)	Depth (Normal) / Rise (%)
CO-2	MH-52A	131.13	MH-52B	124.03	0.013	8.0	2,027.2	0.0035	0.04	0.72	2.00	15.00	1.13	16.7
CO-3	MH-52B	124.03	MH-13	119.96	0.013	8.0	1,161.9	0.0035	0.09	0.72	2.00	15.00	1.40	24.1
CO-4	MH-13	117.22	MH-12	114.32	0.013	8.0	966.0	0.0030	0.27	0.66	2.00	15.00	1.81	44.7
CO-5	MH-53	124.63	MH-13	117.22	0.013	8.0	2,117.0	0.0035	0.08	0.71	2.00	15.00	1.36	22.5
CO-6	MH-14	121.93	MH-13	120.08	0.013	8.0	527.0	0.0035	0.01	0.72	2.00	15.00	0.71	7.5
CO-7	MH-49	131.71	MH-46	122.51	0.013	8.0	2,626.0	0.0035	0.05	0.72	2.00	15.00	1.19	18.1
CO-8	MH-46	122.51	MH-47	119.15	0.013	8.0	960.0	0.0035	0.10	0.71	2.00	15.00	1.46	25.6
CO-9	MH-47	119.15	MH-48	117.30	0.013	10.0	739.0	0.0025	0.25	1.10	2.00	15.00	1.63	32.4
CO-10	MH-48	117.30	MH-12	112.70	0.013	10.0	2,298.0	0.0020	0.59	0.98	2.00	15.00	1.88	55.8
CO-11	MH-50	129.80	MH-47	121.02	0.013	8.0	2,509.0	0.0035	0.07	0.71	2.00	15.00	1.33	21.8
CO-12	MH-51	124.43	MH-48	117.69	0.013	8.0	1,925.0	0.0035	0.14	0.72	2.00	15.00	1.59	30.0
CO-13	MH-08	118.92	MH-11	111.50	0.013	18.0	3,711.0	0.0020	3.05	4.70	2.00	15.00	2.83	58.7
CO-14	MH-12	112.70	MH-11	110.06	0.013	12.0	1,318.0	0.0020	0.96	1.59	2.00	15.00	2.12	55.9
CO-15	MH-43	140.50	MH-44	131.71	0.013	8.0	1,953.0	0.0045	0.31	0.81	2.00	15.00	2.16	42.7
CO-16	MH-44	131.71	MH-45	128.65	0.013	8.0	1,020.0	0.0030	0.51	0.66	2.00	15.00	2.09	65.8
CO-17	MH-45	128.65	MH-07A	124.77	0.013	10.0	971.0	0.0040	0.75	1.38	2.00	15.00	2.59	52.3
CO-18	MH-07A	119.70	MH-08	118.92	0.013	15.0	518.0	0.0015	1.44	2.51	2.00	15.00	2.11	54.3
CO-20	MH-42	140.70	MH-45	128.00	0.013	8.0	3,195.0	0.0040	0.15	0.76	2.00	15.00	1.71	30.5
CO-22	MH-21	157.34	MH-41	151.85	0.013	8.0	1,569.0	0.0035	0.16	0.71	2.00	15.00	1.64	31.9
CO-23	MH-41	151.85	MH-40	147.01	0.013	8.0	1,384.0	0.0035	0.40	0.71	2.00	15.00	2.11	53.8
CO-25	MH-03	125.72	MH-7B	124.42	0.013	8.0	864.0	0.0015	0.10	0.47	2.00	15.00	1.06	31.0
CO-26	MH-7B	124.42	MH-07A	119.70	0.013	10.0	3,151.0	0.0015	0.54	0.85	2.00	15.00	1.65	58.1
CO-27	MH-002	131.36	MH-001	130.06	0.013	8.0	371.0	0.0035	0.18	0.72	2.00	15.00	1.70	34.1
CO-28	MH-001	130.06	MH-7B	124.42	0.013	8.0	1,611.0	0.0035	0.27	0.71	2.00	15.00	1.91	42.6
CO-29	MH-37	165.03	MH-41	153.23	0.013	8.0	1,902.0	0.0062	0.04	0.95	2.00	15.00	1.32	13.4
CO-30	MH-30	169.93	MH-29	166.79	0.013	8.0	897.0	0.0035	0.03	0.71	2.00	15.00	1.00	13.8
CO-31	MH-29	163.39	MH-36	158.78	0.013	8.0	1,316.0	0.0035	0.10	0.72	2.00	15.00	1.43	24.8
CO-32	MH-36	155.68	MH-40	153.53	0.013	8.0	716.0	0.0030	0.18	0.66	2.00	15.00	1.61	35.7
CO-34	MH-17	165.50	MH-35	162.43	0.013	8.0	1,025.0	0.0030	0.18	0.66	2.00	15.00	1.61	35.8
CO-35	MH-40	147.01	MH-35	142.61	0.013	10.0	2,201.0	0.0020	0.76	0.98	2.00	15.00	1.98	66.1
CO-36	MH-31	169.43	MH-17	167.14	0.013	8.0	654.0	0.0035	0.04	0.72	2.00	15.00	1.07	15.3
CO-37	MH-38	169.60	MH-33	164.69	0.013	8.0	1,403.0	0.0035	0.04	0.71	2.00	15.00	1.09	15.6
CO-38	MH-33	164.69	MH-34B	159.65	0.013	8.0	1,677.0	0.0030	0.17	0.66	2.00	15.00	1.59	34.6
CO-41	MH-39	169.21	MH-32	163.68	0.013	8.0	1,581.0	0.0035	0.06	0.71	2.00	15.00	1.23	19.0
CO-42	MH-32	163.68	MH-26	154.44	0.013	12.0	674.0	0.0137	0.09	4.17	2.00	15.00	2.12	9.9
CO-43	MH-34B	157.88	MH-26	154.44	0.013	8.0	981.0	0.0035	0.23	0.72	2.00	15.00	1.83	39.1
CO-45	MH-16	170.00	MH-48	164.50	0.013	8.0	154.0	0.0037	0.10	2.28	2.00	15.00	3.29	14.3
CO-47	MH-48	164.50	MH-49	162.30	0.013	8.0	529.0	0.0042	0.10	0.78	2.00	15.00	1.53	24.3
CO-49	MH-49	162.30	W-1	162.30	0.013	8.0	2.0	0.0000	0.10	0.00	2.00	15.00	0.29	(N/A)
CO-51	MH-34A	136.63	MH-08	118.92	0.013	18.0	6,795.0	0.0026	1.58	5.36	2.00	15.00	2.64	37.2
CO-52	MH-26	154.44	MH-34A	136.63	0.013	12.0	2,353.0	0.0076	0.34	3.10	2.00	15.00	2.58	22.4
CO-54	T-2	167.58	MH-17	165.83	0.013	8.0	738.0	0.0024	0.10	0.59	2.00	15.00	1.27	28.6
CO-55	MH-35	142.61	MH-51	138.48	0.013	12.0	2,066.4	0.0020	1.13	1.59	2.00	15.00	2.20	62.1
CO-56	MH-51	138.48	MH-34A	136.63	0.013	12.0	925.8	0.0020	1.13	1.59	2.00	15.00	2.20	62.1

K:\Projects\Crows Landing\Sewer Model\SewerCAD\AECOM SSWR-MODEL-Rev 1.swc

**Scenario: Phase 1,2,3 - Peak**  
**Current Time Step: 0.000Hr**  
**FlexTable: Manhole Table**

Label	Elevation (Rim) (ft)	Elevation (Invert) (ft)	Flow (Total Out) (cfs)	Hydraulic Grade Line (In) (ft)	Hydraulic Grade Line (Out) (ft)	Headloss (ft)	Is Active?	Sanitary Loads	Sanitary Loads <Count>
MH-51	127.60	124.43	0.14	124.63	124.63	0.00	True	<Collection: 1 item>	1
MH-52A	134.30	131.13	0.04	131.24	131.24	0.00	True	<Collection: 1 item>	1
MH-21	162.00	157.34	0.16	157.55	157.55	0.00	True	<Collection: 1 item>	1
MH-03	145.00	125.72	0.10	125.93	125.93	0.00	True	<Collection: 1 item>	1
MH-001	133.23	130.06	0.27	130.34	130.34	0.00	True	<Collection: 1 item>	1
MH-002	134.53	131.36	0.18	131.59	131.59	0.00	True	<Collection: 1 item>	1
MH-42	143.87	140.70	0.15	140.90	140.90	0.00	True	<Collection: 1 item>	1
MH-43	143.67	140.50	0.31	140.78	140.78	0.00	True	<Collection: 1 item>	1
MH-45	131.17	128.00	0.75	129.09	129.09	0.00	True	<Collection: 1 item>	1
MH-37	168.20	165.03	0.04	165.12	165.12	0.00	True	<Collection: 1 item>	1
MH-08	129.00	118.92	3.05	119.80	119.80	0.00	True	<Collection: 1 item>	1
MH-40	156.86	147.01	0.76	147.56	147.56	0.00	True	<Collection: 1 item>	1
MH-50	132.97	129.80	0.07	129.95	129.95	0.00	True	<Collection: 1 item>	1
MH-46	125.68	122.51	0.10	122.68	122.68	0.00	True	<Collection: 1 item>	1
MH-49	134.88	131.71	0.05	131.83	131.83	0.00	True	<Collection: 1 item>	1
MH-14	128.00	121.93	0.01	121.98	121.98	0.00	True	<Collection: 1 item>	1
MH-48	120.47	117.30	0.59	117.76	117.76	0.00	True	<Collection: 1 item>	1
MH-12	121.00	112.70	0.96	113.26	113.26	0.00	True	<Collection: 1 item>	1
MH-53	127.80	124.63	0.08	124.78	124.78	0.00	True	<Collection: 1 item>	1
MH-13	128.00	117.22	0.27	117.52	117.52	0.00	True	<Collection: 1 item>	1
MH-52B	127.20	124.03	0.09	124.19	124.19	0.00	True	<Collection: 1 item>	1
MH-44	134.88	131.71	0.51	132.15	132.15	0.00	True	<Collection: 1 item>	1
MH-34B	161.05	157.88	0.23	158.14	158.14	0.00	True	<Collection: 1 item>	1
MH-49	175.00	162.30	0.10	163.80	163.80	0.00	True	<Collection: 0 items>	0
MH-48	178.00	164.50	0.10	164.66	164.66	0.00	True	<Collection: 0 items>	0
MH-11	118.00	110.06	4.13	110.84	110.84	0.00	True	<Collection: 1 item>	1
MH-7B	143.00	124.42	0.54	124.90	124.90	0.00	True	<Collection: 1 item>	1
MH-07A	130.00	119.70	1.44	120.38	120.38	0.00	True	<Collection: 1 item>	1
MH-47	122.32	119.15	0.25	119.42	119.42	0.00	True	<Collection: 1 item>	1
MH-26	165.00	154.44	0.34	154.68	154.68	0.00	True	<Collection: 1 item>	1
MH-32	166.85	163.68	0.09	163.80	163.80	0.00	True	<Collection: 1 item>	1
MH-41	155.02	151.85	0.40	152.21	152.21	0.00	True	<Collection: 1 item>	1
MH-34A	159.67	136.63	1.58	137.19	137.19	0.00	True	<Collection: 1 item>	1
MH-51	161.32	138.48	1.13	139.10	139.10	0.00	True	<Collection: 0 items>	0
MH-33	167.86	164.69	0.17	164.92	164.92	0.00	True	<Collection: 1 item>	1
MH-38	172.77	169.60	0.04	169.71	169.71	0.00	True	<Collection: 1 item>	1
MH-35	165.00	142.61	1.13	143.23	143.23	0.00	True	<Collection: 1 item>	1
MH-16	182.00	170.00	0.10	170.14	170.14	0.00	True	<Collection: 1 item>	1
MH-17	171.00	165.83	0.18	165.74	165.74	0.00	True	<Collection: 1 item>	1
MH-31	172.60	169.43	0.04	169.53	169.53	0.00	True	<Collection: 1 item>	1
MH-30	173.10	169.93	0.03	170.02	170.02	0.00	True	<Collection: 1 item>	1
MH-29	169.96	166.79	0.10	163.56	163.56	0.00	True	<Collection: 1 item>	1
MH-36	161.95	155.68	0.18	155.92	155.92	0.00	True	<Collection: 1 item>	1
MH-39	172.38	169.21	0.06	169.34	169.34	0.00	True	<Collection: 1 item>	1

K:\Projects\Crows Landing\Sewer Model\SewerCAD\IAECOM SSWR-MODEL-Rev 1.swc

**Appendix C**  
**Potential Impacts to Patterson Wastewater Facilities from**  
**CLIBP (TM)**

---

To: Ken Irwin, City Manager; Michael H. Willett, Director of Public Works  
From: Alison Furuya, P.E.; Jeff Black, P.E.

Subject: Potential Impacts to Patterson Wastewater Facilities from Crows  
Landing Industrial Business Park

Date: August 25, 2017

### INTRODUCTION

Stanislaus County (County) is proposing to reuse the former Crows Landing Air Facility property and develop the Crows Landing Industrial Business Park (CLIBP). The CLIBP is a planned 1,528 acre business park consisting of public facilities, logistics, industrial, business park, and general aviation land uses. The County is seeking permission to convey the wastewater from the CLIBP to City of Patterson (City) facilities for conveyance, treatment and disposal. This technical memorandum (TM) evaluates the potential impacts of the CLIBP project to the City wastewater collection system and Water Quality Control Facility (WQCF). The evaluation included:

1. A review of the City's Wastewater Master Plan (WWMP) [1] and other recently completed documents related to the City's wastewater facilities.
2. A review of the Wastewater Flow and Load assumptions for the future Crows Landing Industrial Business Park development phases memorandum (CLIBP Wastewater Memo) [2], as well as previous documents relating to wastewater infrastructure for the CLIBP.

### BACKGROUND

#### Crows Landing Industrial Business Park Project

The following is a brief summary of the wastewater information provided in the CLIBP Wastewater Memo. Wastewater flow and loading projections for the CLIBP were developed using the assumptions presented in Table 1.

**Table 1 – CLIBP Wastewater Flow and Loading Assumptions**

Parameter	Value
Airport Users - Dry Weather Loading Factor	4 gpc/day
General Land Users - Dry Weather Loading Factor	1,000 gpd/acre
Wet Weather Loading Factor, Infiltration/Inflow (I/I)	100 gpd/acre
Dry Weather Peaking Factor	3
<u>Raw Wastewater Constituents</u>	
Biochemical Oxygen Demand (BOD <sub>5</sub> )	300 mg/L
Total Suspended Solids (TSS)	300 mg/L
Total Kjeldahl Nitrogen (TKN)	50 mg/L

The CLIBP plan area infrastructure and land use development is anticipated to occur over three ten-year phases. Table 2 summarizes the projected flows and loads associated with each phase and buildout of the CLIBP.

**Table 2 – CLIBP Wastewater Flow and Load Projections**

Parameter	Units	Phase 1 2018-2028	Phase 2 2029-2039	Phase 3 2049-2050	Total (Buildout)
<u>Flow</u>					
Average Dry Weather Flow (ADWF)	mgd	0.394	0.223	0.274	0.891
Peak Dry Weather Flow (PDWF)	mgd	1.182	0.669	0.822	2.673
Peak Wet Weather Flow (PWWF)	mgd	1.259	0.691	0.849	2.799
<u>Loads</u>					
Average BOD <sub>5</sub> Load	lbs/day	986	558	686	2,229
Peak BOD <sub>5</sub> Load	lbs/day	1,282	725	891	2,898
Average TSS Load	lbs/day	986	558	686	2,229
Peak TSS Load	lbs/day	1,282	725	891	2,898
Average TKN Load	lbs/day	164	93	114	372
Peak TKN Load	lbs/day	214	121	149	484

City of Patterson Historical Wastewater Flows and Loads

Wastewater flow and influent data for the past five years were reviewed and are summarized in Tables 3 and 4. Several influent BOD and TSS results were unusually high in 2015 and 2016. These results are not included in the data summarized in Table 5.

**Table 3 – WQCF Average Dry Weather Flow Summary**

Month	WQCF Influent Flow (mgd)				
	2012	2013	2014	2015	2016
June	1.55	1.41	1.45	1.42	1.41
July	1.38	1.41	1.48	1.49	1.39
August	1.43	1.45	1.48	1.41	1.43
Average	<b>1.45</b>	<b>1.42</b>	<b>1.47</b>	<b>1.44</b>	<b>1.41</b>
<b>5-yr Average = 1.44 mgd</b>					

**Table 4 – WQCF Influent BOD and TSS Summary**

Parameter	Units	2012	2013	2014	2015	2016	Average
<b>BOD<sub>5</sub></b>							
Average	mg/L	280	259	287	366	245	<b>287</b>
Minimum	mg/L	180	140	120	160	120	<b>144</b>
Maximum	mg/L	660	520	710	900	970	<b>752</b>
<b>BOD<sub>5</sub> Load</b>							
Average	lbs/d	3,331	3,121	3,500	4,315	2,876	<b>3,429</b>
Minimum	lbs/d	2,106	1,708	1,477	1,829	1,380	<b>1,700</b>
Maximum	lbs/d	7,211	6,462	8,379	9,833	10,792	<b>8,535</b>
<b>TSS</b>							
Average	mg/L	225	235	295	319	208	<b>256</b>
Minimum	mg/L	20	44	110	44	72	<b>58</b>
Maximum	mg/L	810	610	1,000	820	720	<b>792</b>
<b>TSS Load</b>							
Average	lbs/d	2,662	2,834	3,577	3,781	2,436	<b>3,058</b>
Minimum	lbs/d	228	522	1,336	540	862	<b>698</b>
Maximum	lbs/d	8,850	7,336	11,819	9,708	8,010	<b>9,145</b>

City of Patterson Projected Growth

For this evaluation, wastewater flow was estimated to increase at the same rate as projected population growth rates. The City 2015-2023 Housing Element Updated, adopted February 2016 [3] presented population projections and average annual growth rates for the City and Stanislaus County. These population projections are summarized in Table 5.

**Table 5 – Patterson and Stanislaus County Population Projections**

Year	Patterson		Stanislaus County	
	Population	Average Annual Growth Rate	Population	Average Annual Growth Rate
2010	20,413		514,453	
2015	25,065	4.20%	551,668	1.40%
2020	30,375	3.90%	594,146	1.50%
2025	35,685	3.30%	636,625	1.40%
2030	40,995	2.80%	679,403	1.30%
2035	43,559	1.20%	721,582	1.20%
2040	46,124	1.20%	764,060	1.20%
Change/Average	25,711	2.8%	249,607	1.3%

Source: City of Patterson 2015-2023 Housing Element Updated, adopted February 2, 2016 [3]

Projected wastewater flows for the WQCF based on the growth rates presented in Table 5 for the City, with the addition of contributions from Diablo Grande and the CLIBP, are summarized in Table 6. A total ADWF of 1.47 mgd, the maximum ADWF measured for the past 5 years, was used as the starting condition. Average annual growth rates from year 2040-2050 were assumed to be consistent with the growth rate of 1.2% for 2036-2040. The projected buildout flow for the City is also included in the table, and is from the WWMP.

**Table 6 – WQCF ADWF Flow Projections**

Year/Condition	Average Annual Growth Rate <sup>a</sup>	Projected City ADWF (mgd)	Projected Diablo Grande ADWF (mgd)	Projected Total ADWF w/o CLIBP (mgd)	Projected CLIBP ADWF (mgd)	Projected Total ADWF with CLIBP (mgd)
Existing (2016)		1.40	0.04	1.44	-	1.44
2018	3.9%	1.51	0.05	1.56	0.39	1.96
2029	2.8 - 3.3%	2.15	0.11	2.25	0.62	2.87
2040	1.2 - 2.8%	2.49	0.16	2.65	0.89	3.54
2050	1.2%	2.80	0.22	3.02	0.89	3.91
Buildout	-	5.54	0.75	6.29	0.89	7.18

<sup>a</sup> Average annual growth rate assumptions are based on the average annual growth rates for Patterson presented in Table 6.

<sup>b</sup> Assumes an ADWF of 0.032 mgd for Diablo Grande in 2009-2010, with annual increases of 5,250 gpd per year.

The City receives wastewater from the Diablo Grande development, located west of the City limits. The WWMP reported an ADWF for Diablo Grande of 0.032 mgd, based on flow data from 2009-2010. This flow was used as a baseline and was increased by 5,250 gpd per year, based on the assumption that 30 housing units have been and will be added per year, with an average flow of 175 gallons per day (gpd) per unit. This growth assumption for Diablo Grande resulted in an estimated ADWF of 0.04 mgd for



Diablo Grande in 2016. The City is in the process of collecting flow data for Diablo Grande. The most recently collected data indicates that Diablo Grande is discharging average flows in the range of 350,000 to 420,000 gpd, which is significantly higher than the estimate shown in Table 6.

### **POTENTIAL IMPACTS TO COLLECTION SYSTEM**

The CLIBP Wastewater Memo describes the installation of a temporary connection to the existing Western Hills Water District (WHWD) 18-inch sewer trunk line at the intersection of Ward Avenue and Marshall Road to convey CLIBP Phase 1 flows to the City collection system. This temporary connection will be replaced with a permanent connection to the proposed South Patterson Trunk Sewer (SPTS) at the intersection of Bartch Avenue and Ward Avenue, as part of CLIBP Phase 2.

The hydraulic model, developed as part of the WWMP, was evaluated for the existing trunk sewers on Ward Avenue, M Street and Ward Avenue (referred to as the Central Trunk Sewer (CTS) in this TM), and the proposed SPTS. The following two scenarios were executed to determine if the proposed CLIBP wastewater connections could be accommodated by the existing and proposed City collection system.

Scenario 1: CLIBP Phase 1 flows added to southern end of Ward Avenue Trunk Sewer. Diablo Grande ADWF of 0.10 mgd. Complete development of known potential developments in the City, as shown in Figure 1. The developments include: Villages of Patterson, Patterson Gardens, Keystone Business Park, West Ridge Business Park, Villa del Lago, Arambel Business Park, and other small developments.

Scenario 2: CLIBP Buildout flows added to the proposed SPTS. Diablo Grande buildout flows added to the proposed SPTS. Complete development of City General Plan areas.

The City wastewater loads assigned to the manholes were calculated using the method presented in the WWMP, which includes the use of a variable diurnal peaking factor (DPF) to calculate PDWF and an I/I factor based on area served to calculate PWWF. Consistent with the WWMP, Diablo Grande flows were assigned a constant peaking factor of 3.1 and an I/I factor of 300 gpd/ac over an area of 5,070 acres.

Detailed information regarding the hydraulic model, including a listing of the manhole IDs, wastewater loads, and capacity in the trunk sewers on Ward Avenue, Walnut Avenue, M Street, and the SPTS is provided in Appendix A. An overview of the hydraulic model results is provided below.

- As detailed in the WWMP, the hydraulic limitations of pipe segment E5-6:E5:5 on M Street due to a reverse slope were confirmed, and this pipe segment is recommended for replacement.
- The Ward Avenue trunk sewer does not have sufficient capacity to accommodate the known areas in Patterson for potential growth, shown in Figure 1, and the addition of CLIBP Phase 1 flows. To accommodate the CLIBP flows, the existing 21-inch sections would need to be upsized to 24-inches.
- PWWF from Diablo Grande and potential developments in the City are critical to determining the remaining available capacity in the Ward Avenue Trunk Sewer for the CLIBP.
- The SPTS, as proposed in the WWMP, has sufficient capacity to accommodate the projected CLIBP buildout flows. Projected d/D values in the SPTS range from 0.42-0.60.

### **POTENTIAL IMPACTS TO WASTEWATER QUALITY CONTROL FACILITY**

The existing reliable capacity and projected capacity following the completion of future expansion phases for the WQCF are summarized in Table 8. This information originated from the WWMP, with slight adjustments to provide more detail on capacity impacts associated with decommissioning existing facilities as they become antiquated. Additionally, the existing reliable capacity for the WQCF differs from the permitted capacity. The WQCF is currently regulated under Regional Water Quality Control Board (Regional Board) Waste Discharge Requirements Order R5-2007-0147 (WDRs). The WDRs include effluent nitrogen limits which have been challenging for the older treatment facilities at the WQCF to meet. Therefore, the City considers the reliable capacity of the WQCF to be less than the permitted capacity to ensure compliance with the WDRs. Based on the information presented in Table 7, the addition of the CLIBP flows would require an additional expansion project after Phase V.

**Table 7 – WQCF Existing and Anticipated Capacity**

Condition	Reliable Capacity (mgd)	Total Reliable Capacity (mgd)
Existing		1.85
North Activated Sludge Treatment System	0.6	
Advanced Integrated Pond System	0	
South Activated Sludge Treatment System Treatment Train 1	1.25	
Completion of Phase III Expansion		3.1
North Activated Sludge Treatment System	0.6	
Advanced Integrated Pond System	0	
South Activated Sludge Treatment System Treatment Train 1	1.25	
Treatment Train 2	1.25	
Phase IV Expansion		4.25
North Activated Sludge Treatment System	0	
Advanced Integrated Pond System	0	
South Activated Sludge Treatment System Treatment Train 1	1.25	
Treatment Train 2	1.25	
Treatment Train 3	1.75	
Phase V Expansion		6.5
North Activated Sludge Treatment System	0	
Advanced Integrated Pond System	0	
South Activated Sludge Treatment System Treatment Train 1	1.25	
Treatment Train 2	1.25	
Treatment Train 3	2	
Treatment Train 4	2	

Expansion phases are recommended to begin design and permitting seven years prior to reaching the reliable capacity of the facility and construction five years prior to reaching the reliable capacity of the facility. Table 8 presents estimates for the recommended construction completion time for Phase III and IV expansions. The flows to the WQCF are projected to exceed the existing reliable capacity of 1.85 mgd ADWF within the next five years and acceptance of wastewater from the CLIBP is not recommended until construction of Phase III has started. WQCF flows and development projections should be regularly updated to refine the timing for implementation of expansion projects.

**Table 8 – Estimated Timing for WQCF Expansion Projects**

Expansion Phase	Total Reliable Capacity after Expansion Phase Completed (mgd)	Recommended Year to Complete Construction	
		w/out CLIBP	w/ CLIBP
Existing	1.85	-	-
Phase III	3.1	2018	2017
Phase IV	4.25	2045	2028

Projected BOD, TSS, and TKN strength for the CLIBP are similar to historical WQCF influent concentrations and are not anticipated to be an issue.

**DEVELOPER IMPACT FEES AND COST SHARING**

Collection System

The WWMP provided cost estimates for construction of the SPTS. These costs are summarized in Table 9. Table 10 provides a summary of the wastewater loads which the SPTS is planned to accept.

**Table 9 – Costs for South Patterson Trunk Sewer Components**

Project Components	Base Cost
Junction Structure <sup>a</sup>	495,000
South Patterson Trunk Sewer	3,897,000
South Patterson Pump Station	640,000
South Patterson Force Main	635,000
Base Construction Cost	5,700,000
Probable Construction Cost <sup>b</sup>	8,379,000

<sup>a</sup> Base cost listed is half of the total cost because the junction structure will be for the North Patterson Trunk Sewer as well.

<sup>b</sup> Probable construction cost includes applying contingencies for planning and design (10%), construction management (10%), and construction (20%), to the Base Construction Cost to obtain a subtotal cost. An additional 5% contingency for program administration is applied to the subtotal cost to obtain the Probable Construction Cost.

**Table 10 – South Patterson Trunk Sewer Design Wastewater Loads**

Development Area	ADWF (gpd)
Diablo Grande	750,000
Crows Landing Industrial Business Park	891,000
Development in south Patterson	823,060
Projected ADWF Capacity Increase	2,464,060

Based on this information, incremental capacity is being provided at an approximate cost of \$3.40/gpd ADWF. This unit cost can be used as an initial guide for developing impact fees for the collection system.

Wastewater Quality Control Facility

A conceptual list of components for the Phase IV expansion project is provided in Table 11. Budgetary costs are included with the list. The costs provided are based on cost estimates for the Phase III expansion project. The cost estimate indicates that expansion of treatment and disposal capacity is approximately \$30/gpd ADWF.

**Table 11 – Budgetary Phase IV Expansion Project Costs**

Project Components	Probable Construction Cost (in \$1,000,000)
Influent Pump Station	5.00
South Activated Sludge Treatment System, Unit 3	6.00
Solids Handling Facilities	5.50
Effluent Pumping Facilities	2.50
Plant Water System Improvements	0.50
Stormwater/Site Drainage Improvements	1.00
Electrical and Controls	4.00
Demolition of NASTS facilities	1.00
Site Piping	1.00
Site Grading and Surfacing Improvements	1.00
Tertiary Filters	3.00
Disinfection Facilities	2.00
Odor Control	1.00
Percolation Pond Expansion	2.00
Base Construction Cost	35.50
<i>10% Planning and design contingency</i>	<i>3.55</i>
<i>10% Construction management contingency</i>	<i>3.55</i>
<i>20% Construction contingency</i>	<i>7.10</i>
Subtotal	49.70
<i>5% Program Administration contingency</i>	<i>2.49</i>
Total Project Cost	52.19
WQCF Capacity Increase	1.75 mgd
Cost per gallon capacity	\$30

<sup>a</sup> Percolation Pond Expansion cost includes land acquisition.

CLIBP Wastewater Cost Share Estimate

Table 12 presents an estimated cost share for the CLIBP for expanding the wastewater collection and WQCF facilities to accommodate the projected flows from the project. The total estimated CLIBP cost

share is \$29.8 million. The cost share does not include improvements to the existing City wastewater facilities that may be needed to accommodate CLIBP flows on a temporary basis.

**Table 12 – Estimated CLIBP Cost Share for Expanding City Wastewater Facilities**

Description	Value
Collection System Expansion Unit Cost	\$3.40/gpd ADWF
WQCF Phase IV Expansion Project Unit Cost	\$30/gpd ADWF
CLIBP Buildout ADWF	0.891 mgd
CLIBP Buildout Cost Share	\$29.8M

**SUMMARY**

The findings from this evaluation are summarized below.

1. The existing collection system does not have sufficient capacity to accept the CLIBP Phase 1 flows and known potential developments in the City.
2. Recommended improvements to the collection system can be implemented to increase capacity in the existing system to accept CLIBP Phase 1 flows. These improvements include:
  - a. Replacement of pipe segment E5-6:E5:5 on M Street, as previously identified in the WWMP.
  - b. Upsizing of approximately 1,300 feet of 21-inch pipe in Ward Avenue.
3. The WQCF Phase III Expansion Project should be completed prior to accepting flow from the CLIBP. Accepting the CLIBP flows would be dependent on priority developments within the City.
4. The WQCF Phase IV Expansion Project should be planned for completion in the year 2028, if CLIBP wastewater is treated by the City.
5. The estimated CLIBP cost share for expanding the City wastewater facilities is \$29.8 million.
6. The estimates presented in this TM are based on growth and flow assumptions. These assumptions should be reviewed regularly.

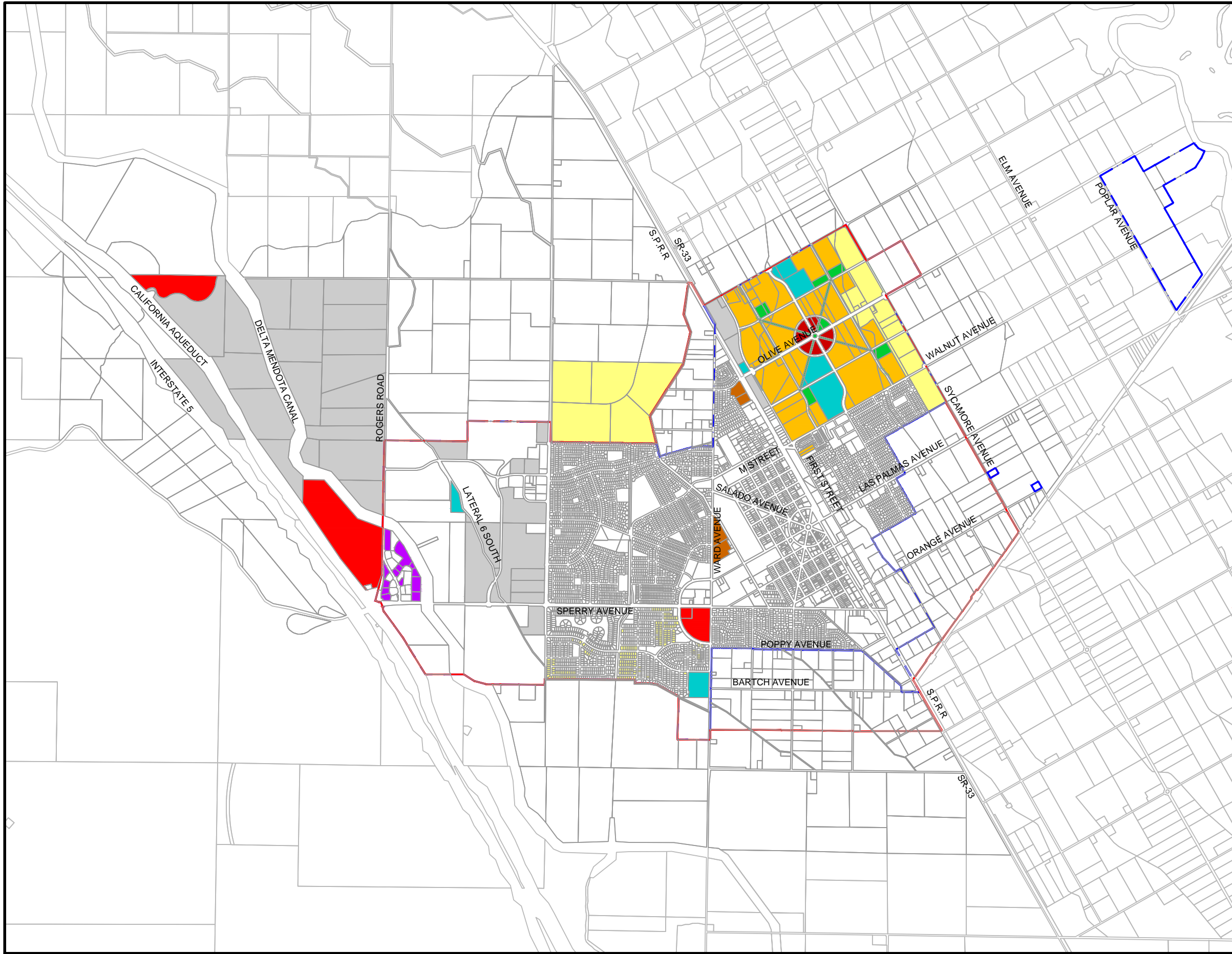
**REFERENCES**

[1] City of Patterson Wastewater Master Plan, prepared by Black Water Consulting Engineers, Inc. and NV5, April 2016

[2] Wastewater Flow and Load assumptions for the future Crows Landing Industrial Business Park development phases memorandum, prepared by AECOM, July 6, 2017

[3] City of Patterson 2015-2023 Housing Element Update, adopted February 2, 2016

I:\116125 CITY OF PATTERSON\TASKS\125-178 CLBP EVALUATION\CAD\EXHIBITS\FIGURES\125\_FIGURE 2.DWG PLOT: 8/8/2017 4:38:47 PM BY KEVIN WILLIAMS



# LEGEND

- RESIDENTIAL**
  - ER ESTATE RESIDENTIAL
  - LDR LOW-DENSITY RESIDENTIAL
  - MDR MEDIUM-DENSITY RESIDENTIAL
  - HDR HIGH-DENSITY RESIDENTIAL
  - DR DOWNTOWN RESIDENTIAL
- COMMERCIAL**
  - HSC HIGHWAY SERVICE COMMERCIAL
  - DC DOWNTOWN CORE
  - GC GENERAL COMMERCIAL
  - MU MIXED-USE
  - MP MEDICAL PROFESSIONAL
- INDUSTRIAL**
  - LI LIGHT INDUSTRIAL
  - HI HEAVY INDUSTRIAL
- PUBLIC**
  - P/QP PUBLIC / QUASI-PUBLIC
  - P/OS PARKS / OPEN SPACE
- BOUNDARY**
  - CL CITY LIMITS
  - SOI SPHERE OF INFLUENCE

## FIGURE 1

CITY OF PATTERSON  
 CLBP SCENARIO  
 ADDITIONAL DEVELOPED PARCELS

0 3000' 6000'

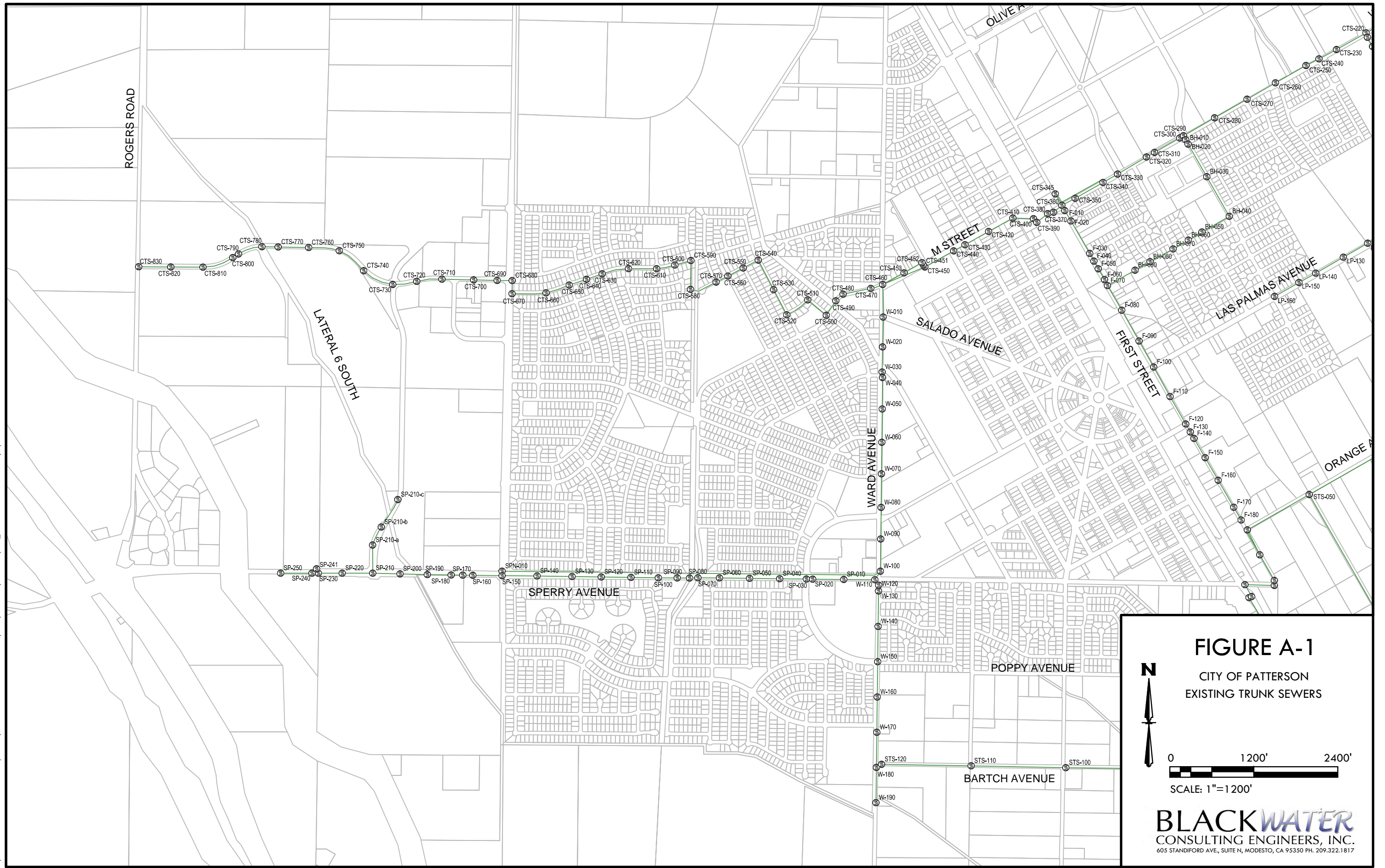
SCALE: 1"=3000'

**BLACKWATER**  
 CONSULTING ENGINEERS, INC.  
 605 STANDIFORD AVE, SUITE N, MODESTO, CA 95350 PH. 209.322.1817

**APPENDIX A**  
**HYDRAULIC MODEL RESULTS**



I:\116125 CITY OF PATTERSON\TASKS\125-178 CLUP EVALUATION\CAD\EXHIBITS\FIGURES\125-FIGURE 3.DWG PLOT: 8/8/2017 4:24:58 PM BY KEVIN WILLIAMS



### FIGURE A-1

CITY OF PATTERSON  
EXISTING TRUNK SEWERS



0 1200' 2400'

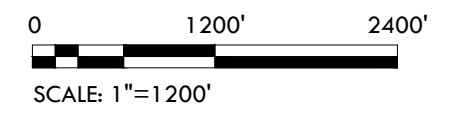
SCALE: 1"=1200'

**BLACKWATER**  
CONSULTING ENGINEERS, INC.  
605 STANDIFORD AVE., SUITE N, MODESTO, CA 95350 PH. 209.322.1817

I:\16125 CITY OF PATTERSON\TASKS\125-17B CUBP EVALUATION\CAD\EXHIBITS\FIGURES\1\_25\_FIGURE 3.DWG PLOT: 8/8/2017 4:25:28 PM BY KEVIN WILLIAMS



**FIGURE A-2**  
CITY OF PATTERSON  
EXISTING TRUNK SEWERS



**BLACK WATER**  
CONSULTING ENGINEERS, INC.  
605 STANDIFORD AVE., SUITE N, MODESTO, CA 95350 PH. 209.322.1817

**Appendix A**  
**Scenario 1: CLIBP Phase 1 (Year 2018-2028)**  
**Manhole Loading Calculations**

ID	Additional			Diurnal				Model MH Load (gpd)
	ADWF @ MH (gpd)	Additional I/I @ MH (gpd)	Total ADWF @ MH (gpd)	Peaking Factor	Total PWWF @ MH (gpd)	Total I/I @ MH (gpd)	Total PWWF @ MH (gpd)	
BH-010	0	0	55,074	3.33	183,278	88,973	272,251	0
BH-020	0	0	55,074	3.33	183,278	88,973	272,251	0
BH-030	0	0	55,074	3.33	183,278	88,973	272,251	0
BH-040	698	4,398	55,074	3.33	183,278	88,973	272,251	6,670
BH-050	13,128	19,888	54,376	3.33	181,006	84,575	265,582	62,878
BH-060	2,915	3,774	41,249	3.35	138,017	64,687	202,704	13,382
BH-070	15,525	20,100	38,333	3.35	128,409	60,913	189,321	71,643
BH-080	22,808	40,813	22,808	3.37	76,866	40,813	117,678	117,678
BH-090	0	0	0	3.40	0	0	0	0
CTS-010	0	0	2,546,651	1.58	3,553,569	5,627,556	9,181,125	0
CTS-020	72,176	255,258	2,546,651	1.58	3,553,569	5,627,556	9,181,125	369,296
CTS-030	0	0	2,474,475	1.58	3,439,531	5,372,298	8,811,829	0
CTS-040	0	0	2,474,475	1.58	3,439,531	5,372,298	8,811,829	0
CTS-050	0	0	2,474,475	1.58	3,439,531	5,372,298	8,811,829	0
CTS-060	0	0	2,474,475	1.58	3,439,531	5,372,298	8,811,829	0
CTS-070	0	0	2,474,475	1.58	3,439,531	5,372,298	8,811,829	0
CTS-080	0	0	2,474,475	1.58	3,439,531	5,372,298	8,811,829	0
CTS-090	0	0	2,474,475	1.58	3,439,531	5,372,298	8,811,829	0
CTS-100	0	0	2,474,475	1.58	3,439,531	5,372,298	8,811,829	0
CTS-110	0	0	2,474,475	1.58	3,439,531	5,372,298	8,811,829	0
CTS-120	0	0	2,474,475	1.58	3,439,531	5,372,298	8,811,829	0
CTS-130	0	0	2,474,475	1.58	3,439,531	5,372,298	8,811,829	0
CTS-140	0	0	2,474,475	1.58	3,439,531	5,372,298	8,811,829	0
CTS-150	0	0	2,474,475	1.58	3,439,531	5,372,298	8,811,829	0
CTS-160	0	0	2,474,475	1.58	3,439,531	5,372,298	8,811,829	0
CTS-170	0	0	2,474,475	1.58	3,439,531	5,372,298	8,811,829	0
CTS-180	0	0	2,474,475	1.58	3,439,531	5,372,298	8,811,829	0
CTS-190	0	0	2,474,475	1.58	3,439,531	5,372,298	8,811,829	0
CTS-200	0	0	2,474,475	1.58	3,439,531	5,372,298	8,811,829	0
CTS-210	0	0	2,474,475	1.58	3,439,531	5,372,298	8,811,829	0
CTS-220	268,839	405,388	2,474,475	1.58	3,439,531	5,372,298	8,811,829	1,052,774
CTS-230	0	0	2,120,677	1.58	2,880,530	4,878,524	7,759,054	0
CTS-240	15,334	22,693	2,120,677	1.58	2,880,530	4,878,524	7,759,054	46,921
CTS-250	0	0	2,105,343	1.58	2,856,302	4,855,831	7,712,133	0
CTS-260	0	0	2,105,343	1.58	2,856,302	4,855,831	7,712,133	0
CTS-270	33,022	42,752	2,105,343	1.58	2,856,302	4,855,831	7,712,133	94,928
CTS-280	0	0	2,072,321	1.58	2,804,127	4,813,079	7,617,206	0
CTS-290	0	0	2,072,321	1.58	2,804,127	4,813,079	7,617,206	175,990
CTS-300	7,581	9,903	2,017,247	1.58	2,717,110	4,724,105	7,441,215	21,882
CTS-310	0	0	2,009,666	1.58	2,705,132	4,714,202	7,419,334	0
CTS-320	9,080	11,861	2,009,666	1.58	2,705,132	4,714,202	7,419,334	26,207
CTS-330	3,811	5,364	2,000,586	1.58	2,690,786	4,702,341	7,393,127	11,384
CTS-340	5,539	17,119	1,996,775	1.58	2,684,765	4,696,978	7,381,743	25,871
CTS-350	0	0	1,991,236	1.58	2,676,013	4,679,858	7,355,872	0
CTS-360	13	106	1,991,236	1.58	2,676,013	4,679,858	7,355,872	1,115,324
CTS-370	0	0	1,660,602	1.58	2,153,612	4,086,936	6,240,548	0
CTS-380	0	0	1,660,602	1.58	2,153,612	4,086,936	6,240,548	0
CTS-390	0	0	1,660,602	1.58	2,153,612	4,086,936	6,240,548	0
CTS-400	0	0	1,660,602	1.58	2,153,612	4,086,936	6,240,548	0
CTS-410	17,054	27,290	1,660,602	1.58	2,153,612	4,086,936	6,240,548	54,236
CTS-420	8,107	11,090	1,643,548	1.58	2,126,666	4,059,646	6,186,312	23,899
CTS-430	110,773	128,317	1,635,441	1.58	2,113,857	4,048,556	6,162,413	303,338
CTS-440	0	0	1,524,668	1.58	1,938,835	3,920,239	5,859,074	0
CTS-450	6,952	23,748	1,524,668	1.58	1,938,835	3,920,239	5,859,074	34,733

**Appendix A**  
**Scenario 1: CLIBP Phase 1 (Year 2018-2028)**  
**Manhole Loading Calculations**

ID	Additional			Diurnal				Model MH Load (gpd)
	ADWF @ MH (gpd)	Additional I/I @ MH (gpd)	Total ADWF @ MH (gpd)	Peaking Factor	Total PWWF @ MH (gpd)	Total I/I @ MH (gpd)	Total PWWF @ MH (gpd)	
CTS-451	0	0	1,517,715	1.58	1,927,850	3,896,491	5,824,341	0
CTS-452	0	0	1,517,715	1.58	1,927,850	3,896,491	5,824,341	0
CTS-453	7,580	11,388	1,517,715	1.58	1,927,850	3,896,491	5,824,341	23,364
CTS-460	247,797	363,619	1,510,136	1.58	1,915,874	3,885,103	5,800,977	4,366,322
CTS-470	0	0	247,406	3.08	760,995	673,660	1,434,655	0
CTS-480	0	0	247,406	3.08	760,995	673,660	1,434,655	0
CTS-490	0	0	247,406	3.08	760,995	673,660	1,434,655	0
CTS-500	162	210	247,406	3.08	760,995	673,660	1,434,655	657
CTS-510	4,108	7,710	247,244	3.08	760,548	673,449	1,433,998	19,037
CTS-520	1,805	2,337	243,136	3.08	749,221	665,739	1,414,960	7,328
CTS-530	2,116	2,740	241,331	3.08	744,230	663,402	1,407,632	8,602
CTS-540	12,489	16,804	239,215	3.09	738,367	660,663	1,399,030	51,643
CTS-550	4,838	6,264	226,726	3.10	703,528	643,859	1,347,387	19,870
CTS-560	12,121	35,406	221,888	3.11	689,921	637,595	1,327,516	69,762
CTS-570	5,442	7,045	209,767	3.13	655,564	602,190	1,257,754	22,594
CTS-580	26,546	41,483	204,325	3.13	640,015	595,145	1,235,160	118,451
CTS-590	427	677	177,779	3.17	563,047	553,662	1,116,709	1,930
CTS-600	1,134	1,468	177,353	3.17	561,795	552,984	1,114,779	4,797
CTS-610	18,010	27,690	176,219	3.17	558,465	551,517	1,109,982	81,033
CTS-620	2,066	2,674	158,209	3.19	505,123	523,827	1,028,949	8,846
CTS-630	44,436	65,087	156,144	3.20	498,950	521,153	1,020,103	200,577
CTS-640	0	0	111,708	3.25	363,461	456,065	819,526	0
CTS-650	48,084	64,927	111,708	3.25	363,461	456,065	819,526	217,368
CTS-660	1,784	2,310	63,624	3.32	211,020	391,138	602,158	8,082
CTS-670	3,756	14,737	61,841	3.32	205,248	388,829	594,077	26,916
CTS-680	4,378	16,008	58,085	3.32	193,068	374,092	567,160	30,253
CTS-690	775	4,568	53,707	3.33	178,824	358,084	536,908	7,095
CTS-700	1,808	10,704	52,932	3.33	176,297	353,516	529,813	16,603
CTS-710	1,640	9,567	51,124	3.33	170,397	342,812	513,209	14,926
CTS-720	1,982	7,009	49,484	3.34	165,039	333,245	498,284	13,496
CTS-730	16,305	111,614	47,502	3.34	158,552	326,236	484,787	165,370
CTS-740	439	3,535	31,197	3.36	104,795	214,622	319,417	4,991
CTS-750	11,904	84,068	30,758	3.36	103,339	211,087	314,426	123,768
CTS-760	2,619	10,623	18,854	3.38	63,639	127,019	190,658	19,409
CTS-770	0	0	16,235	3.38	54,853	116,396	171,250	0
CTS-780	0	0	16,235	3.38	54,853	116,396	171,250	0
CTS-790	0	0	16,235	3.38	54,853	116,396	171,250	0
CTS-800	10,890	73,344	16,235	3.38	54,853	116,396	171,250	110,063
CTS-810	0	0	5,344	3.39	18,134	43,053	61,186	0
CTS-820	5,344	43,053	5,344	3.39	18,134	43,053	61,186	61,186
CTS-830	0	0	0	3.40	0	0	0	0
F-010	0	0	330,621	2.97	980,914	592,816	1,573,731	0
F-020	1,562	8,713	330,621	2.97	980,914	592,816	1,573,731	12,674
F-030	5,580	8,866	329,058	2.97	976,953	584,104	1,561,056	23,069
F-040	0	0	323,478	2.98	962,749	575,237	1,537,987	0
F-050	1,410	1,825	323,478	2.98	962,749	575,237	1,537,987	5,427
F-060	232,069	328,155	322,068	2.98	959,148	573,412	1,532,560	991,919
F-070	2,706	3,503	89,999	3.28	295,385	245,257	540,642	12,074
F-080	973	3,648	87,293	3.29	286,814	241,754	528,568	6,736
F-090	3,300	18,402	86,320	3.29	283,726	238,106	521,832	28,889
F-100	0	0	83,020	3.29	273,239	219,704	492,943	0
F-110	0	0	83,020	3.29	273,239	219,704	492,943	0
F-120	0	0	83,020	3.29	273,239	219,704	492,943	0
F-130	0	0	83,020	3.29	273,239	219,704	492,943	0

**Appendix A**  
**Scenario 1: CLIBP Phase 1 (Year 2018-2028)**  
**Manhole Loading Calculations**

ID	Additional			Diurnal				Model MH Load (gpd)
	ADWF @ MH (gpd)	Additional I/I @ MH (gpd)	Total ADWF @ MH (gpd)	Peaking Factor	Total PWWF @ MH (gpd)	Total I/I @ MH (gpd)	Total PWWF @ MH (gpd)	
F-140	0	0	83,020	3.29	273,239	219,704	492,943	0
F-150	0	0	83,020	3.29	273,239	219,704	492,943	0
F-160	0	0	83,020	3.29	273,239	219,704	492,943	0
F-170	14,154	78,936	83,020	3.29	273,239	219,704	492,943	124,243
F-180	68,866	140,768	68,866	3.31	227,931	140,768	368,700	368,700
LP-010	0	0	84,958	3.29	279,403	88,387	367,790	0
LP-020	0	0	84,958	3.29	279,403	88,387	367,790	0
LP-030	0	0	84,958	3.29	279,403	88,387	367,790	0
LP-040	13,115	13,677	84,958	3.29	279,403	88,387	367,790	55,574
LP-050	0	0	71,843	3.31	237,506	74,710	312,216	0
LP-060	0	0	71,843	3.31	237,506	74,710	312,216	0
LP-070	0	0	71,843	3.31	237,506	74,710	312,216	0
LP-080	1,130	3,996	71,843	3.31	237,506	74,710	312,216	7,626
LP-090	0	0	70,714	3.31	233,876	70,714	304,589	0
LP-100	0	0	70,714	3.31	233,876	70,714	304,589	0
LP-110	0	0	70,714	3.31	233,876	70,714	304,589	0
LP-120	0	0	70,714	3.31	233,876	70,714	304,589	0
LP-130	0	0	70,714	3.31	233,876	70,714	304,589	0
LP-140	0	0	70,714	3.31	233,876	70,714	304,589	0
LP-150	0	0	70,714	3.31	233,876	70,714	304,589	0
LP-160	54,461	70,714	70,714	3.31	233,876	70,714	304,589	304,589
SP-010	4,031	14,988	492,065	2.76	1,355,833	1,302,841	2,658,674	23,519
SP-020	0	0	488,034	2.76	1,347,303	1,287,853	2,635,156	0
SP-030	124,749	225,240	488,034	2.76	1,347,303	1,287,853	2,635,156	510,264
SP-040	0	0	363,285	2.92	1,062,279	1,062,612	2,124,892	0
SP-050	0	0	363,285	2.92	1,062,279	1,062,612	2,124,892	0
SP-060	0	0	363,285	2.92	1,062,279	1,062,612	2,124,892	0
SP-070	8,805	13,423	363,285	2.92	1,062,279	1,062,612	2,124,892	35,081
SP-080	0	0	354,479	2.94	1,040,621	1,049,190	2,089,811	0
SP-090	0	0	354,479	2.94	1,040,621	1,049,190	2,089,811	0
SP-100	91,804	143,909	354,479	2.94	1,040,621	1,049,190	2,089,811	381,822
SP-110	0	0	262,675	3.06	802,708	905,281	1,707,989	0
SP-120	0	0	262,675	3.06	802,708	905,281	1,707,989	0
SP-130	0	0	262,675	3.06	802,708	905,281	1,707,989	0
SP-140	0	0	262,675	3.06	802,708	905,281	1,707,989	0
SP-150	4,709	17,819	262,675	3.06	802,708	905,281	1,707,989	30,617
SP-160	0	0	257,966	3.06	789,910	887,462	1,677,372	0
SP-170	0	0	257,966	3.06	789,910	887,462	1,677,372	0
SP-180	0	0	257,966	3.06	789,910	887,462	1,677,372	0
SP-190	3,140	11,347	257,966	3.06	789,910	887,462	1,677,372	19,914
SP-200	0	0	254,826	3.07	781,343	876,114	1,657,458	0
SP-210	579	2,349	254,826	3.07	781,343	876,114	1,657,458	3,932
SP-210-a	0	0	254,247	3.07	779,760	873,765	1,653,525	0
SP-210-b	0	0	254,247	3.07	779,760	873,765	1,653,525	0
SP-210-c	24,768	100,447	254,247	3.07	779,760	873,765	1,653,525	168,963
SP-220	0	0	229,479	3.10	711,244	773,318	1,484,562	0
SP-230	195,536	677,861	229,479	3.10	711,244	773,318	1,484,562	1,275,206
SP-240	0	0	33,944	3.36	113,899	95,457	209,356	0
SP-241	33,944	95,457	33,944	3.36	113,899	95,457	209,356	209,356
SP-250	0	0	0	3.40	0	0	0	0
W-010	17,123	60,555	1,014,932	2.20	2,324,692	2,847,824	5,172,516	78,122
W-020	0	0	997,810	2.22	2,307,125	2,787,269	5,094,394	0
W-030	0	0	997,810	2.22	2,307,125	2,787,269	5,094,394	0
W-040	0	0	997,810	2.22	2,307,125	2,787,269	5,094,394	0

**Appendix A**  
**Scenario 1: CLIBP Phase 1 (Year 2018-2028)**  
**Manhole Loading Calculations**

ID	Additional			Diurnal				
	ADWF @ MH (gpd)	Additional I/I @ MH (gpd)	Total ADWF @ MH (gpd)	Peaking Factor	Total PWWF @ MH (gpd)	Total I/I @ MH (gpd)	Total PWWF @ MH (gpd)	Model MH Load (gpd)
W-050	5,468	4,485	997,810	2.22	2,307,125	2,787,269	5,094,394	10,257
W-060	0	0	992,342	2.23	2,301,353	2,782,784	5,084,137	0
W-070	6,027	4,943	992,342	2.23	2,301,353	2,782,784	5,084,137	11,395
W-080	0	0	986,315	2.24	2,294,900	2,777,841	5,072,741	0
W-090	0	0	986,315	2.24	2,294,900	2,777,841	5,072,741	0
W-100	0	0	986,315	2.24	2,294,900	2,777,841	5,072,741	0
W-110	0	0	986,315	2.24	2,294,900	2,777,841	5,072,741	2,150,725
W-120	0	0	494,250	2.88	1,447,016	1,475,000	2,922,016	0
W-130	0	0	494,250	2.88	1,447,016	1,475,000	2,922,016	0
W-140	0	0	494,250	2.88	1,447,016	1,475,000	2,922,016	0
W-150	0	0	494,250	2.88	1,447,016	1,475,000	2,922,016	0
W-160	0	0	494,250	2.88	1,447,016	1,475,000	2,922,016	0
W-170	0	0	494,250	2.88	1,447,016	1,475,000	2,922,016	0
W-180	0	0	494,250	2.88	1,447,016	1,475,000	2,922,016	0
W-190	494,250	1,475,000	494,250	2.88	1,447,016	1,475,000	2,922,016	2,922,016

2,036,148 City ADWF MH Load total  
86,788 NPTS and SPTS flows from developed land (not included in this scenario)  
2,122,937 Total City ADWF  
100,250 Diablo Grande ADWF, assumed for Year 2028  
394,000 Plus CLIBP Phase 1 flow  


---

2,617,187 TOTAL ADWF

Other Assumptions

3.1 Diablo Grande separate Diurnal Peaking Factor (constant)  
310,775 Diablo Grande Peak Dry Weather Flow (assumed constant throughout the system)  
1,398,000 Diablo Grande I/I flow assumed  
77,000 Plus CLIBP Phase 1 I/I flow

For sewers with flow from Diablo Grande (W trunk sewers and sewers downstream of CTS-460):

Diurnal Peaking Factor (DPF) =  $3.4 - 1.31 * (\text{Total ADWF [mgd]} - \text{Diablo Grande ADWF [mgd]})$ , with a minimum value of 1.58  
Total PDWF =  $(\text{Total ADWF} - \text{Diablo Grande Buildout ADWF}) * \text{DPF} + \text{Diablo Grande Buildout ADWF} * \text{Diablo Grande separate Diurnal Peaking Factor}$   
Total PWWF = Total PDWF + Total I/I  
Model MH Load = Total PWWF @ MH - Total PWWF @ upstream manhole

For sewers with no flow from Diablo Grande:

Diurnal Peaking Factor (DPF) =  $3.4 - 1.31 * \text{Total ADWF [mgd]}$ , with a minimum value of 1.58  
Total PDWF = Total ADWF \* DPF  
Total PWWF = Total PDWF + Total I/I  
Model MH Load = Total PWWF @ MH - Total PWWF @ upstream manhole

**Appendix A**  
**Scenario 2: Buildout**  
**Manhole Loading Calculations**  
**South Patterson Trunk Sewer**

ID	Additional ADWF @ MH (gpd)	Additional I/I @ MH (gpd)	Total ADWF @ MH (gpd)	Diurnal	Total PDWF @ MH (gpd)	Total I/I @ MH (gpd)	Total PWWF @ MH (gpd)	Model MH Load (gpd)
				Peaking Factor				
STS-030	101,862	116,873	2,464,060	1.58	5,033,214	2,788,936	7,822,150	277,814
STS-040	54,010	56,324	2,362,198	1.58	4,872,273	2,672,063	7,544,336	141,660
STS-050	115,529	182,544	2,308,188	1.58	4,786,937	2,615,739	7,402,676	365,080
STS-060	19,195	56,070	2,192,659	1.58	4,604,402	2,433,195	7,037,597	86,398
STS-080	136,858	233,103	2,173,465	1.58	4,574,074	2,377,125	6,951,199	276,232
STS-090	35,242	43,440	2,036,607	1.71	4,530,945	2,144,021	6,674,967	46,092
STS-100	105,148	148,250	2,001,365	1.76	4,528,293	2,100,582	6,628,875	175,501
STS-110	92,471	143,225	1,896,217	1.90	4,501,042	1,952,332	6,453,374	191,130
STS-120	1,803,746	1,809,106	1,803,746	2.02	4,453,138	1,809,106	6,262,244	6,262,244

Assumptions

750,000 Diablo Grande Buildout ADWF

891,000 CLIBP Buildout flow

3.1 Diablo Grande separate Diurnal Peaking Factor (constant)

2,325,000 Diablo Grande Peak Dry Weather Flow (assumed constant throughout the system)

1,398,000 Diablo Grande I/I flow assumed

126,000 CLIBP Buildout I/I flow

Diurnal Peaking Factor (DPF) =  $3.4 - 1.31 * (\text{Total ADWF [mgd]} - \text{Diablo Grande ADWF [mgd]})$ , with a minimum value of 1.58

Total PDWF =  $(\text{Total ADWF} - \text{Diablo Grande Buildout ADWF}) * \text{DPF} + \text{Diablo Grande Buildout ADWF} * \text{Diablo Grande separate Diurnal Peaking Factor}$

Total PWWF = Total PDWF + Total I/I

Model MH Load = Total PWWF @ MH - Total PWWF @ upstream manhole

**Appendix A**  
**Scenario 1: CLIBP Phase 1 (Year 2018-2028)**  
**Ward Avenue Trunk Sewer**  
**Manhole Results**

<b>ID</b>	<b>Rim Elevation (ft)</b>	<b>Total Flow (gpd)</b>	<b>Grade (ft)</b>	<b>Status</b>	<b>Hydraulic Jump</b>	<b>Surcharge Depth (ft)</b>	<b>Unfilled Depth (ft)</b>
W-010	103	78,121.59	93.84	Not Full	No	0.14	9.16
W-020	104.6	0	94.88	Not Full	No	0.38	9.72
W-030	106.9	0	95.92	Not Full	No	0.71	10.98
W-040	106.9	0	95.96	Not Full	No	0.59	10.94
W-050	108.8	10,256.95	96.75	Not Full	No	-0.58	12.05
W-060	110.7	0	98.68	Not Full	No	-0.61	12.02
W-070	112.6	11,394.94	100.49	Not Full	No	-0.56	12.11
W-080	113.9	0	102.32	Not Full	No	-0.59	11.58
W-090	115.7	0	104.18	Not Full	No	-0.59	11.52
W-100	117.8	0	106.04	Not Full	No	-0.59	11.76
W-110	119.6	2,150,713.82	106.92	Not Full	Yes	-0.50	12.68
W-120	119.05	0	108.29	Not Full	No	-0.93	10.76
W-130	119.8	0	112.18	Not Full	No	-0.83	7.62
W-140	122.6	0	117.12	Not Full	No	-0.81	5.48
W-150	125.59	0	120.24	Not Full	No	-0.69	5.35
W-160	128.6	0	123.20	Not Full	No	-0.69	5.40
W-170	131.99	0	124.67	Not Full	No	-0.32	7.32
W-180	135.66	0	125.77	Not Full	Yes	-0.32	9.89
W-190	139.02	2,922,000.81	133.56	Not Full	No	-0.79	5.46



**Appendix A**  
**Scenario 1: CLIBP Phase 1 (Year 2018-2028)**  
**Ward Avenue Trunk Sewer**  
**Pipe Results**

ID	Diameter (in)	Length (ft)	Slope	Total Flow (gpd)	Flow Type	Velocity (ft/s)	d/D	q/Q	Water Depth (ft)	Critical Depth (ft)	Froude Number	Full Flow (gpd)	Coverage Count	Backwater Adjustment	Adjusted Depth (ft)	Adjusted Velocity
																(ft/s)
W-010:CTS-460	21	421	0.002	5,172,488.11	Pressurized	3.33	1.00	1.07	1.75	1.02	0.44	4,851,952.10	0	No	1.75	3.33
W-020:W-010	21	421	0.002	5,094,366.52	Pressurized	3.28	1.00	1.14	1.75	0.97	0.44	4,476,077.23	0	Yes	1.75	3.28
W-030:W-020	21	421	0.002	5,094,366.52	Pressurized	3.28	1.00	1.21	1.75	0.94	0.44	4,216,787.86	0	Yes	1.75	3.28
W-040:W-030	21	14	0.004	5,094,366.52	Pressurized	4.76	0.65	0.76	1.14	1.04	0.84	6,722,104.09	0	Yes	1.75	3.28
W-050:W-040	21	465	0.004	5,094,366.52	Free Surface	4.63	0.67	0.78	1.17	1.04	0.80	6,494,169.53	0	Yes	1.70	3.30
W-060:W-050	21	465	0.004	5,084,109.57	Free Surface	4.72	0.65	0.76	1.14	1.04	0.83	6,666,458.58	0	Yes	1.16	4.67
W-070:W-060	21	465	0.004	5,084,109.57	Free Surface	4.52	0.68	0.81	1.19	1.04	0.77	6,317,183.37	0	No	1.19	4.52
W-080:W-070	21	465	0.004	5,072,714.63	Free Surface	4.62	0.67	0.78	1.16	1.04	0.80	6,494,169.53	0	Yes	1.18	4.56
W-090:W-080	21	465	0.004	5,072,714.63	Free Surface	4.62	0.67	0.78	1.16	1.04	0.80	6,494,169.53	0	No	1.16	4.62
W-100:W-090	21	465	0.004	5,072,714.63	Free Surface	4.62	0.67	0.78	1.16	1.04	0.80	6,494,169.53	0	No	1.16	4.62
W-110:W-100	21	172	0.003	5,072,714.63	Free Surface	4.28	0.71	0.86	1.25	1.04	0.70	5,911,079.91	0	No	1.25	4.28
W-120:W-110	18	95	0.02	2,922,000.81	Free Surface	7.38	0.38	0.30	0.57	0.82	2.00	9,601,425.61	0	Yes	0.83	4.52
W-130:W-120	18	85	0.011	2,922,000.81	Free Surface	5.93	0.45	0.41	0.67	0.82	1.46	7,120,305.60	0	No	0.67	5.93
W-140:W-130	18	500	0.01	2,922,000.81	Free Surface	5.66	0.46	0.44	0.69	0.82	1.36	6,683,518.26	0	No	0.69	5.66
W-150:W-140	18	500	0.006	2,922,000.81	Free Surface	4.68	0.54	0.56	0.81	0.82	1.03	5,184,186.52	0	No	0.81	4.68
W-160:W-150	18	500	0.006	2,922,000.81	Free Surface	4.65	0.54	0.57	0.81	0.82	1.02	5,148,309.37	0	No	0.81	4.65
W-170:W-160	18	500	0.002	2,922,000.81	Free Surface	3.04	0.79	0.96	1.18	0.82	0.49	3,044,259.15	0	No	1.18	3.04
W-180:W-170	18	500	0.002	2,922,000.81	Free Surface	3.04	0.79	0.96	1.18	0.82	0.49	3,044,259.15	0	No	1.18	3.04
W-190:W-180	18	500	0.009	2,922,000.81	Free Surface	5.46	0.48	0.46	0.71	0.82	1.29	6,371,162.40	0	No	0.71	5.46

**Appendix A**  
**Scenario 1: CLIBP Phase 1 (Year 2018-2028)**  
**Central Trunk Sewer**  
**Manhole Results**

ID	Rim Elevation	Total Flow (gpd)	Grade (ft)	Status	Hydraulic	Surcharge	Unfilled
	(ft)				Jump	Depth (ft)	Depth (ft)
CTS-010	55	0	46.26	Not Full	No	0.01	8.74
CTS-020	55	369,294.08	46.29	Not Full	No	0.04	8.71
CTS-030	55	0	46.45	Not Full	No	-0.11	8.56
CTS-040	54.5	0	46.55	Not Full	No	-0.20	7.95
CTS-050	55	0	46.81	Not Full	No	-0.45	8.19
CTS-060	56	0	47.05	Not Full	Yes	-0.68	8.96
CTS-070	56	0	51.92	Not Full	No	-0.98	4.08
CTS-080	56.56	0	53.39	Not Full	No	-1.51	3.17
CTS-090	57.97	0	54.60	Not Full	No	-1.21	3.38
CTS-100	59.36	0	55.48	Not Full	No	-1.21	3.88
CTS-110	60.81	0	56.42	Not Full	No	-1.21	4.39
CTS-120	62.15	0	57.29	Not Full	No	-1.21	4.86
CTS-130	63.59	0	58.22	Not Full	No	-1.21	5.38
CTS-140	65.02	0	59.13	Not Full	No	-1.21	5.89
CTS-150	66.41	0	60.03	Not Full	No	-1.21	6.38
CTS-160	67.8	0	60.92	Not Full	No	-1.21	6.88
CTS-170	70	0	61.80	Not Full	No	-1.21	8.20
CTS-180	70.51	0	62.66	Not Full	No	-1.21	7.85
CTS-190	71.99	0	63.61	Not Full	No	-1.21	8.38
CTS-200	73.39	0	64.52	Not Full	No	-1.21	8.88
CTS-210	74.84	0	65.44	Not Full	No	-1.21	9.40
CTS-220	76	1,052,768.53	66.19	Not Full	No	-1.21	9.81
CTS-230	77.3	0	67.28	Not Full	No	-1.16	10.02
CTS-240	78.11	46,920.76	68.07	Not Full	No	-1.13	10.04
CTS-250	78.63	0	68.57	Not Full	No	-1.18	10.06
CTS-260	79.95	0	69.85	Not Full	No	-1.13	10.10
CTS-270	81.23	94,927.51	70.97	Not Full	No	-1.08	10.26
CTS-280	82.64	0	72.21	Not Full	No	-1.14	10.43
CTS-290	84	175,989.09	73.53	Not Full	Yes	-1.17	10.47
CTS-300	84	21,881.89	73.57	Not Full	No	-1.36	10.43
CTS-310	86	0	74.77	Not Full	No	-1.10	11.23
CTS-320	86	26,206.86	75.04	Not Full	No	-1.33	10.96
CTS-330	88	11,383.94	76.19	Not Full	Yes	-1.00	11.81
CTS-340	89	25,870.87	77.10	Not Full	No	-1.13	11.90
CTS-350	90	0	78.65	Not Full	Yes	-1.04	11.35
CTS-360	90	1,115,318.20	80.31	Not Full	No	-1.09	9.69
CTS-370	90	0	80.92	Not Full	No	-1.17	9.08
CTS-380	90	0	81.13	Not Full	No	-1.17	8.87

**Appendix A**  
**Scenario 1: CLIBP Phase 1 (Year 2018-2028)**  
**Central Trunk Sewer**  
**Manhole Results**

ID	Rim Elevation	Total Flow (gpd)	Grade (ft)	Status	Hydraulic	Surcharge	Unfilled
	(ft)				Jump	Depth (ft)	Depth (ft)
CTS-390	91	0	82.19	Not Full	Yes	-1.17	8.81
CTS-400	91.5	0	82.79	Not Full	No	-1.37	8.71
CTS-410	92.5	54,235.72	84.11	Not Full	Yes	-1.16	8.39
CTS-420	94	23,898.88	86.26	Not Full	No	-1.25	7.74
CTS-430	96	303,336.42	88.15	Not Full	No	-1.18	7.85
CTS-440	97	0	88.92	Not Full	Yes	-1.12	8.08
CTS-450	99	34,732.82	90.96	Not Full	No	-1.24	8.04
CTS-451	99	0	91.60	Not Full	No	-0.63	7.41
CTS-452	99	0	92.23	Not Full	No	0.03	6.78
CTS-453	100.5	23,363.88	92.51	Not Full	No	0.03	7.99
CTS-460	102.3	4,366,299.30	92.74	Not Full	No	0.06	9.56
CTS-470	103.2	0	92.80	Not Full	No	-0.12	10.40
CTS-480	103.9	0	92.85	Not Full	No	-0.13	11.05
CTS-490	104.3	0	92.88	Not Full	No	-0.14	11.42
CTS-500	103.9	656.997	92.93	Not Full	No	-0.58	10.97
CTS-510	105	19,036.90	93.01	Not Full	No	-0.84	11.99
CTS-520	106.3	7,327.96	93.36	Not Full	No	-0.86	12.95
CTS-530	105.4	8,601.96	93.76	Not Full	No	-0.86	11.64
CTS-540	104.5	51,642.73	94.07	Not Full	No	-0.86	10.43
CTS-550	105.2	19,869.90	94.32	Not Full	No	-0.88	10.88
CTS-560	105.8	69,761.64	94.49	Not Full	No	-0.89	11.31
CTS-570	105.9	22,593.88	94.60	Not Full	No	-0.91	11.30
CTS-580	110	118,450.38	94.90	Not Full	No	-0.92	15.10
CTS-590	108.65	1,929.99	95.31	Not Full	No	-1.02	13.34
CTS-600	109.07	4,796.98	96.48	Not Full	No	-1.02	12.59
CTS-610	108.7	81,032.58	96.71	Not Full	No	-1.03	11.99
CTS-620	109.94	8,845.95	98.61	Not Full	No	-0.71	11.33
CTS-630	112.4	200,575.96	100.17	Not Full	No	-0.71	12.23
CTS-640	114.09	0	100.93	Not Full	No	-0.73	13.16
CTS-650	116.51	217,365.87	101.98	Not Full	Yes	-0.79	14.53
CTS-660	118.42	8,081.96	104.71	Not Full	No	-0.61	13.71
CTS-670	121.22	26,915.86	107.26	Not Full	No	-0.60	13.96
CTS-680	121.6	30,252.84	109.11	Not Full	No	-0.61	12.49
CTS-690	122.6	7,094.96	109.95	Not Full	No	-0.61	12.66
CTS-700	124.05	16,602.91	111.60	Not Full	Yes	-0.61	12.45
CTS-710	126.5	14,925.92	113.83	Not Full	No	-0.64	12.68
CTS-720	128.5	13,495.93	115.64	Not Full	No	-0.62	12.86
CTS-730	130.5	165,369.14	117.42	Not Full	No	-0.63	13.08

**Appendix A**  
**Scenario 1: CLIBP Phase 1 (Year 2018-2028)**  
**Central Trunk Sewer**  
**Manhole Results**

ID	Rim Elevation	Total Flow (gpd)	Grade (ft)	Status	Hydraulic	Surcharge	Unfilled
	(ft)				Jump	Depth (ft)	Depth (ft)
CTS-740	132.9	4,990.97	119.60	Not Full	No	-0.70	13.30
CTS-750	135.4	123,767.36	121.85	Not Full	No	-0.70	13.55
CTS-760	139	19,408.90	124.03	Not Full	No	-0.77	14.97
CTS-770	142.7	0	126.27	Not Full	No	-0.78	16.43
CTS-780	145.1	0	127.61	Not Full	Yes	-0.79	17.49
CTS-790	147.8	0	133.41	Not Full	No	-0.83	14.40
CTS-800	148.7	110,062.43	134.18	Not Full	No	-0.81	14.53
CTS-810	153	0	137.69	Not Full	No	-0.88	15.31
CTS-820	155.8	61,185.68	141.34	Not Full	No	-0.88	14.46
CTS-830	160	0	144.87	Not Full	No	-1.00	15.13

**Appendix A**  
**Scenario 1: CLIBP Phase 1 (Year 2018-2028)**  
**Central Trunk Sewer**  
**Pipe Results**

ID	Diameter (in)	Length (ft)	Slope	Total Flow (gpd)	Flow Type	Velocity		d/D	q/Q	Water Depth (ft)	Critical Depth (ft)	Froude Number	Full Flow (gpd)	Backwater Adjustment	Adjusted Depth (ft)	Adjusted Velocity (ft/s)
						Velocity (ft/s)										
CTS-020:CTS-010	33	38	0.001	9,181,073.27	Pressurized	3.54	0.64	0.74	1.76	1.23	0.51	12,432,136.22	Yes	2.75	2.39	
CTS-030:CTS-020	33	230	0.001	8,811,779.19	Free Surface	3.50	0.62	0.71	1.72	1.21	0.51	12,377,965.43	Yes	2.72	2.30	
CTS-040:CTS-030	33	154	0.001	8,811,779.19	Free Surface	3.50	0.62	0.71	1.72	1.21	0.51	12,351,144.24	Yes	2.60	2.35	
CTS-050:CTS-040	33	392	0.001	8,811,779.19	Free Surface	3.50	0.62	0.71	1.72	1.21	0.51	12,362,167.13	Yes	2.42	2.46	
CTS-060:CTS-050	33	354	0.001	8,811,779.19	Free Surface	3.50	0.62	0.71	1.72	1.21	0.51	12,354,632.77	Yes	2.19	2.69	
CTS-070:CTS-060	18	25	0.257	8,811,779.19	Free Surface	25.27	0.35	0.26	0.52	1.37	7.24	34,522,489.34	Yes	1.30	8.40	
CTS-080:CTS-070	33	200	0.004	8,811,779.19	Free Surface	5.23	0.45	0.42	1.24	1.21	0.94	20,987,861.52	No	1.24	5.23	
CTS-090:CTS-080	33	500	0.002	8,811,779.19	Free Surface	3.97	0.56	0.61	1.55	1.21	0.62	14,540,817.00	No	1.55	3.97	
CTS-100:CTS-090	33	494	0.002	8,811,779.19	Free Surface	3.97	0.56	0.61	1.54	1.21	0.62	14,547,356.61	Yes	1.55	3.97	
CTS-110:CTS-100	33	517	0.002	8,811,779.19	Free Surface	3.98	0.56	0.60	1.54	1.21	0.63	14,614,070.95	Yes	1.54	3.98	
CTS-120:CTS-110	33	478	0.002	8,811,779.19	Free Surface	3.99	0.56	0.60	1.54	1.21	0.63	14,621,712.29	Yes	1.54	3.98	
CTS-130:CTS-120	33	511	0.002	8,811,779.19	Free Surface	3.97	0.56	0.61	1.55	1.21	0.62	14,542,397.78	No	1.55	3.97	
CTS-140:CTS-130	33	507	0.002	8,811,779.19	Free Surface	3.98	0.56	0.60	1.54	1.21	0.63	14,599,651.54	Yes	1.54	3.98	
CTS-150:CTS-140	33	496	0.002	8,811,779.19	Free Surface	3.98	0.56	0.60	1.54	1.21	0.63	14,599,331.59	No	1.54	3.98	
CTS-160:CTS-150	33	494	0.002	8,811,779.19	Free Surface	3.97	0.56	0.61	1.54	1.21	0.62	14,547,356.61	No	1.54	3.97	
CTS-170:CTS-160	33	488	0.002	8,811,779.19	Free Surface	3.97	0.56	0.61	1.54	1.21	0.62	14,554,053.98	Yes	1.54	3.97	
CTS-180:CTS-170	33	477	0.002	8,811,779.19	Free Surface	3.97	0.56	0.61	1.54	1.21	0.62	14,552,667.02	No	1.54	3.97	
CTS-190:CTS-180	33	525	0.002	8,811,779.19	Free Surface	3.98	0.56	0.60	1.54	1.21	0.63	14,579,234.02	Yes	1.54	3.97	
CTS-200:CTS-190	33	500	0.002	8,811,779.19	Free Surface	3.97	0.56	0.61	1.55	1.21	0.62	14,540,817.00	No	1.55	3.97	
CTS-210:CTS-200	33	513	0.002	8,811,779.19	Free Surface	3.98	0.56	0.60	1.54	1.21	0.63	14,592,689.71	Yes	1.54	3.97	
CTS-220:CTS-210	33	414	0.002	8,811,779.19	Free Surface	3.98	0.56	0.60	1.54	1.21	0.63	14,587,572.16	No	1.54	3.98	
CTS-230:CTS-220	30	481	0.003	7,759,010.66	Free Surface	4.47	0.54	0.56	1.34	1.16	0.76	13,765,531.98	Yes	1.44	4.09	
CTS-240:CTS-230	30	304	0.003	7,759,010.66	Free Surface	4.35	0.55	0.58	1.37	1.16	0.73	13,290,480.64	No	1.37	4.35	
CTS-250:CTS-240	30	195	0.003	7,712,089.91	Free Surface	4.55	0.53	0.55	1.32	1.16	0.78	14,116,749.94	Yes	1.35	4.43	
CTS-260:CTS-250	30	493	0.002	7,712,089.91	Free Surface	4.34	0.55	0.58	1.37	1.16	0.73	13,276,994.60	No	1.37	4.34	
CTS-270:CTS-260	30	480	0.002	7,712,089.91	Free Surface	4.16	0.57	0.62	1.42	1.16	0.68	12,549,948.77	No	1.42	4.16	
CTS-280:CTS-270	30	527	0.002	7,617,162.40	Free Surface	4.31	0.55	0.58	1.36	1.15	0.73	13,201,918.62	Yes	1.39	4.21	
CTS-290:CTS-280	30	510	0.003	7,617,162.40	Free Surface	4.43	0.53	0.56	1.33	1.15	0.76	13,675,791.75	Yes	1.35	4.37	
CTS-300:CTS-290	30	42	0.005	7,441,173.32	Free Surface	5.77	0.43	0.38	1.07	1.14	1.13	19,670,253.44	Yes	1.24	4.76	
CTS-310:CTS-300	30	442	0.002	7,419,291.43	Free Surface	4.05	0.56	0.61	1.40	1.14	0.67	12,258,108.89	No	1.40	4.05	
CTS-320:CTS-310	30	127	0.004	7,419,291.43	Free Surface	5.10	0.47	0.45	1.17	1.14	0.95	16,678,378.46	Yes	1.29	4.51	
CTS-330:CTS-320	30	475	0.002	7,393,084.57	Free Surface	3.73	0.60	0.67	1.50	1.13	0.59	11,044,112.05	No	1.50	3.73	
CTS-340:CTS-330	27	233	0.006	7,381,700.63	Free Surface	5.79	0.50	0.49	1.12	1.17	1.09	14,933,653.74	Yes	1.31	4.77	
CTS-350:CTS-340	27	349	0.004	7,355,829.76	Free Surface	5.21	0.54	0.57	1.21	1.17	0.93	12,981,141.89	No	1.21	5.21	
CTS-360:CTS-350	27	351	0.005	7,355,829.76	Free Surface	5.52	0.52	0.53	1.16	1.17	1.02	14,008,565.97	Yes	1.19	5.36	
CTS-370:CTS-360	27	154	0.004	6,240,511.56	Free Surface	5.13	0.48	0.47	1.08	1.07	0.99	13,434,248.20	Yes	1.12	4.90	
CTS-380:CTS-370	27	47	0.004	6,240,511.56	Free Surface	5.13	0.48	0.47	1.08	1.07	0.99	13,415,593.83	No	1.08	5.13	
CTS-390:CTS-380	27	235	0.005	6,240,511.56	Free Surface	5.15	0.48	0.46	1.08	1.07	0.99	13,479,326.22	Yes	1.08	5.14	
CTS-400:CTS-390	27	64	0.009	6,240,511.56	Free Surface	6.73	0.39	0.32	0.88	1.07	1.47	19,432,774.93	No	0.88	6.73	
CTS-410:CTS-400	27	233	0.004	6,240,511.56	Free Surface	5.07	0.48	0.47	1.09	1.07	0.97	13,213,927.18	No	1.09	5.07	

**Appendix A**  
**Scenario 1: CLIBP Phase 1 (Year 2018-2028)**  
**Central Trunk Sewer**  
**Pipe Results**

ID	Diameter (in)	Length (ft)	Slope	Total Flow (gpd)	Flow Type	Velocity		q/Q	Water	Critical	Froude	Full Flow (gpd)	Backwater Adjustment	Adjusted Depth (ft)	Adjusted
						(ft/s)	d/D		Depth (ft)	Depth (ft)	Number				Velocity (ft/s)
CTS-420:CTS-410	27	396	0.006	6,186,275.84	Free Surface	5.58	0.45	0.41	1.00	1.07	1.12	15,094,738.68	Yes	1.05	5.29
CTS-430:CTS-420	27	404	0.005	6,162,376.96	Free Surface	5.13	0.48	0.46	1.07	1.06	0.99	13,470,824.99	No	1.07	5.13
CTS-440:CTS-430	27	211	0.003	5,859,040.54	Free Surface	4.54	0.50	0.50	1.13	1.04	0.85	11,642,255.59	No	1.13	4.54
CTS-450:CTS-440	27	431	0.005	5,859,040.54	Free Surface	5.26	0.45	0.41	1.01	1.04	1.06	14,208,146.39	Yes	1.07	4.87
CTS-451:CTS-450	27	23	0.001	5,155,703.30	Free Surface	2.60	0.72	0.87	1.63	0.97	0.37	5,918,344.79	No	1.63	2.60
CTS-452:CTS-451	27	7	-0.003	5,155,703.30	Pressurized	2.01	1.00		2.25	0.00	0.24		No	2.25	2.01
CTS-453:CTS-452	27	318	0.001	5,155,703.30	Pressurized	2.01	1.00	1.08	2.25	0.93	0.24	4,774,983.50	No	2.25	2.01
CTS-460:CTS-450	12	655	0.001	668,604.42	Pressurized	1.32	1.00	1.07	1.00	0.41	0.23	625,005.78	Yes	1.00	1.32
CTS-460:CTS-453	27	350	0.001	5,132,339.42	Pressurized	2.00	1.00	1.07	2.25	0.93	0.24	4,797,667.63	Yes	2.25	2.00
CTS-470:CTS-460	21	279	0.002	1,434,644.54	Free Surface	2.53	0.39	0.33	0.69	0.54	0.62	4,390,122.23	Yes	1.75	0.92
CTS-480:CTS-470	21	272	0	1,434,644.54	Free Surface	1.12	0.77	0.94	1.35	0.54	0.17	1,525,052.52	Yes	1.62	0.95
CTS-490:CTS-480	21	161	0	1,434,644.54	Free Surface	1.18	0.73	0.89	1.28	0.54	0.19	1,618,492.47	Yes	1.62	0.96
CTS-500:CTS-490	21	247	0.001	1,434,644.54	Free Surface	1.76	0.52	0.53	0.91	0.54	0.37	2,693,826.43	Yes	1.23	1.23
CTS-510:CTS-500	21	348	0.001	1,433,987.55	Free Surface	1.76	0.52	0.53	0.91	0.54	0.37	2,696,557.12	Yes	0.99	1.58
CTS-520:CTS-510	21	370	0.001	1,414,950.64	Free Surface	1.77	0.51	0.52	0.90	0.53	0.37	2,721,945.58	No	0.90	1.77
CTS-530:CTS-520	21	438	0.001	1,407,622.68	Free Surface	1.77	0.51	0.52	0.89	0.53	0.37	2,731,727.77	No	0.89	1.77
CTS-540:CTS-530	21	441	0.001	1,399,020.73	Free Surface	1.76	0.51	0.51	0.89	0.53	0.37	2,722,420.32	Yes	0.89	1.76
CTS-550:CTS-540	21	245	0.001	1,347,378.00	Free Surface	1.74	0.50	0.50	0.87	0.52	0.37	2,704,799.29	No	0.87	1.74
CTS-560:CTS-550	21	250	0.001	1,327,508.10	Free Surface	1.76	0.49	0.48	0.86	0.52	0.38	2,755,242.79	Yes	0.87	1.73
CTS-570:CTS-560	21	185	0.001	1,257,746.46	Free Surface	1.72	0.48	0.46	0.84	0.50	0.38	2,721,945.58	Yes	0.85	1.69
CTS-580:CTS-570	21	442	0.001	1,235,152.58	Free Surface	1.71	0.47	0.45	0.83	0.50	0.38	2,719,338.92	Yes	0.83	1.70
CTS-590:CTS-580	21	450	0.001	1,116,702.20	Free Surface	1.83	0.42	0.36	0.73	0.47	0.44	3,099,411.91	Yes	0.73	1.83
CTS-600:CTS-590	21	247	0.001	1,114,772.21	Free Surface	1.82	0.42	0.36	0.73	0.47	0.43	3,064,477.87	No	0.73	1.82
CTS-610:CTS-600	21	264	0.001	1,109,975.23	Free Surface	1.83	0.41	0.36	0.72	0.47	0.44	3,095,973.85	Yes	0.73	1.82
CTS-620:CTS-610	15	396	0.004	1,028,942.65	Free Surface	3.13	0.43	0.39	0.54	0.50	0.86	2,644,203.91	No	0.54	3.13
CTS-630:CTS-620	15	389	0.004	1,020,096.70	Free Surface	3.12	0.43	0.39	0.54	0.50	0.86	2,650,949.73	Yes	0.54	3.11
CTS-640:CTS-630	15	259	0.003	819,520.74	Free Surface	2.65	0.41	0.36	0.52	0.44	0.75	2,297,266.68	Yes	0.53	2.58
CTS-650:CTS-640	15	246	0.005	819,520.74	Free Surface	3.08	0.37	0.29	0.46	0.44	0.93	2,811,952.17	Yes	0.49	2.85
CTS-660:CTS-650	12	355	0.007	602,154.87	Free Surface	3.30	0.39	0.32	0.39	0.41	1.08	1,882,460.56	No	0.39	3.30
CTS-670:CTS-660	12	428	0.006	594,072.91	Free Surface	3.15	0.40	0.33	0.40	0.40	1.02	1,778,603.06	No	0.40	3.15
CTS-680:CTS-670	12	310	0.006	567,157.05	Free Surface	3.13	0.39	0.32	0.39	0.39	1.03	1,788,379.52	Yes	0.39	3.07
CTS-690:CTS-680	12	166	0.005	536,904.21	Free Surface	2.88	0.40	0.33	0.40	0.38	0.94	1,632,559.67	No	0.40	2.88
CTS-700:CTS-690	12	334	0.005	529,809.25	Free Surface	2.87	0.39	0.33	0.39	0.38	0.93	1,627,664.43	Yes	0.39	2.86
CTS-710:CTS-700	12	367	0.006	513,206.33	Free Surface	3.07	0.37	0.28	0.37	0.37	1.04	1,807,766.31	Yes	0.38	2.91
CTS-720:CTS-710	12	360	0.005	498,280.41	Free Surface	2.83	0.38	0.31	0.38	0.37	0.94	1,632,559.67	No	0.38	2.83
CTS-730:CTS-720	12	359	0.005	484,784.48	Free Surface	2.80	0.37	0.30	0.37	0.36	0.94	1,630,284.32	Yes	0.38	2.77
CTS-740:CTS-730	12	450	0.005	319,415.34	Free Surface	2.50	0.30	0.20	0.30	0.29	0.95	1,632,559.67	Yes	0.34	2.13
CTS-750:CTS-740	12	450	0.005	314,424.37	Free Surface	2.48	0.30	0.19	0.30	0.29	0.95	1,632,559.67	Yes	0.30	2.47
CTS-760:CTS-750	12	450	0.005	190,657.01	Free Surface	2.15	0.23	0.12	0.23	0.22	0.94	1,632,559.67	Yes	0.26	1.78
CTS-770:CTS-760	12	450	0.005	171,248.11	Free Surface	2.09	0.22	0.11	0.22	0.21	0.94	1,632,559.67	Yes	0.23	2.01

**Appendix A**  
**Scenario 1: CLIBP Phase 1 (Year 2018-2028)**  
**Central Trunk Sewer**  
**Pipe Results**

ID	Diameter (in)	Length (ft)	Slope	Total Flow (gpd)	Flow Type	Velocity		q/Q	Water	Critical	Froude	Full Flow (gpd)	Backwater Adjustment	Adjusted Depth (ft)	Adjusted
						(ft/s)	d/D		Depth (ft)	Depth (ft)	Number				Velocity (ft/s)
CTS-780:CTS-770	12	244	0.006	171,248.11	Free Surface	2.16	0.21	0.10	0.21	0.21	0.99	1,717,339.00	Yes	0.22	2.12
CTS-790:CTS-780	12	354	0.012	171,248.11	Free Surface	2.87	0.18	0.07	0.18	0.21	1.45	2,565,211.33	No	0.18	2.87
CTS-800:CTS-790	12	95	0.008	171,248.11	Free Surface	2.45	0.20	0.08	0.20	0.21	1.17	2,051,412.00	No	0.20	2.45
CTS-810:CTS-800	12	449	0.008	61,185.68	Free Surface	1.81	0.12	0.03	0.12	0.13	1.12	2,064,467.81	Yes	0.16	1.20
CTS-820:CTS-810	12	456	0.008	61,185.68	Free Surface	1.81	0.12	0.03	0.12	0.13	1.12	2,065,608.79	Yes	0.12	1.81
CTS-830:CTS-820	12	456	0.008	0	Free Surface	0.00	0.00		0.00	0.00	0.00	2,065,608.79	Yes	0.06	0.00

**Appendix A**  
**Scenario 2: Buildout**  
**South Patterson Trunk Sewer**  
**Manhole Results**

<b>ID</b>	<b>Rim Elevation (ft)</b>	<b>Total Flow (gpd)</b>	<b>Grade (ft)</b>	<b>Status</b>	<b>Hydraulic Jump</b>	<b>Surcharge Depth (ft)</b>	<b>Unfilled Depth (ft)</b>
STS-010	55	0	47.331	Not Full	No	-1.569	7.669
STS-020	67	0	58.938	Not Full	No	-1.562	8.062
STS-030	75	277,812.56	63.039	Not Full	No	-1.561	11.961
STS-040	76	141,659.26	67	Not Full	No	-1.6	9
STS-050	93	365,078.10	79.853	Not Full	No	-1.747	13.147
STS-060	96	86,397.55	83.245	Not Full	No	-1.555	12.755
STS-070	108	0	98.402	Not Full	No	-1.398	9.598
STS-080	109	276,230.56	99.677	Not Full	No	-1.123	9.323
STS-090	122	46,091.76	106.888	Not Full	No	-1.112	15.112
STS-100	127	175,500.09	111.9	Not Full	No	-1.1	15.1
STS-110	133	191,129.01	118.094	Not Full	No	-0.806	14.906
STS-120	136	6,262,211.45	125.198	Not Full	No	-0.802	10.802



**Appendix A**  
**Scenario 2: Buildout**  
**South Patterson Trunk Sewer**  
**Pipe Results**

Pipe ID	Diameter (in)	Length (ft)	Slope	Total Flow (gpd)	Velocity (ft/s)	d/D	q/Q	Water Depth (ft)	Critical Depth (ft)	Froude Number	Full Flow (gpd)
STS-010:CTS-010	36	2,730.00	0.002	7,822,110.34	3.64	0.48	0.46	1.43	1.10	0.61	16,953,783.51
STS-020:STS-010	36	5,684.00	0.002	7,822,110.34	3.61	0.48	0.47	1.44	1.10	0.60	16,813,011.21
STS-030:STS-020	36	2,715.00	0.002	7,822,110.34	3.61	0.48	0.47	1.44	1.10	0.60	16,796,945.88
STS-040:STS-030	36	2,586.00	0.002	7,544,297.78	3.61	0.47	0.44	1.40	1.08	0.61	16,999,613.48
STS-050:STS-040	36	3,947.00	0.002	7,402,638.52	4.09	0.42	0.37	1.25	1.07	0.74	20,293,145.75
STS-060:STS-050	36	2,653.00	0.001	7,037,560.41	3.23	0.48	0.47	1.45	1.05	0.54	15,011,693.05
STS-070:STS-060	30	1,627.00	0.004	6,951,162.86	5.16	0.44	0.40	1.10	1.10	0.99	17,310,174.73
STS-080:STS-070	30	353	0.002	6,951,162.86	3.88	0.55	0.59	1.38	1.10	0.65	11,836,746.59
STS-090:STS-080	30	2,076.00	0.002	6,674,932.30	3.69	0.56	0.60	1.39	1.07	0.61	11,221,679.74
STS-100:STS-090	30	1,927.00	0.002	6,628,840.54	3.63	0.56	0.60	1.40	1.07	0.60	10,999,850.82
STS-110:STS-100	24	1,353.00	0.004	6,453,340.45	5.11	0.60	0.67	1.19	1.13	0.90	9,680,947.36
STS-120:STS-110	24	1,280.00	0.004	6,262,211.45	4.93	0.60	0.67	1.20	1.11	0.87	9,344,099.15

**Appendix D**  
**Water Balance Data**

---

**Table 1.** Crows Landing - Irrigation Demand Calculation for an average year.

Calendar Month <b>(1)</b>	Reference		Precipitation, P (Average)		Irrigation Hydraulic		
	Evapotranspiration, ET <sub>o</sub>				Loading Rate, L ft./month <b>(4)</b>	Irrigation Demand	
	in. <b>(2)</b>	ft.	in.	ft.		gal./month	AF/month <b>(5)</b>
Jan	1.40	0.12	2.36	0.20	-0.16	0	0.0
Feb	2.28	0.19	2.00	0.17	-0.02	0	0.0
Mar	4.16	0.35	1.86	0.16	0.19	15,931,742	48.89
Apr	5.55	0.46	0.98	0.08	0.45	37,564,925	115.28
May	7.79	0.65	0.43	0.04	0.76	63,092,389	193.62
Jun	8.68	0.72	0.12	0.01	0.89	74,226,682	227.79
Jul	8.23	0.69	0.02	0.00	0.86	71,372,882	219.04
Aug	7.28	0.61	0.04	0.00	0.76	62,897,671	193.03
Sep	5.79	0.48	0.17	0.01	0.58	48,559,159	149.02
Oct	4.09	0.34	0.60	0.05	0.35	29,001,028	89.00
Nov	1.99	0.17	1.20	0.10	0.05	4,267,162	13.10
Dec	1.36	0.11	2.03	0.17	-0.12	0	0.00
<b>Totals</b>	<b>58.60</b>	<b>4.88</b>	<b>11.81</b>	<b>0.98</b>	<b>4.59</b>	<b>406,913,639</b>	<b>1,248.77</b>

**Percent Irrig.**

(A) Irrigation Application Area, acres:	254.8	20%
(B) Crop Coefficient, unitless:	0.8	
(C) Irrigation Efficiency, percent:	70	
(D) Leaching Requirement, percent:	10	

**Conversions**

325851 1 acre-ft to gallons of water  
43560 1 acre to SF

Estimated Field Area (acres) 217.35

**Table 2.** Water balance using Average Dry Weather Flow.

Calendar		Average Dry Weather Flow gpd (8)	Recycled Water Production, Q		Irrigation Demand		Change in Storage	
Month (6)	Days (7)		gal./month (9)	AF/month	gal./month (10)	AF/month	gal./month (11)	AF/month
Jan	31	891,000	27,621,000	84.77	0	0.00	27,621,000	84.77
Feb	28	891,000	24,948,000	76.56	0	0.00	24,948,000	76.56
Mar	31	891,000	27,621,000	84.77	15,931,742	48.89	11,689,258	35.87
Apr	30	891,000	26,730,000	82.03	37,564,925	115.28	-10,834,925	-33.25
May	31	891,000	27,621,000	84.77	63,092,389	193.62	-35,471,389	-108.86
Jun	30	891,000	26,730,000	82.03	74,226,682	227.79	-47,496,682	-145.76
Jul	31	891,000	27,621,000	84.77	71,372,882	219.04	-43,751,882	-134.27
Aug	31	891,000	27,621,000	84.77	62,897,671	193.03	-35,276,671	-108.26
Sep	30	891,000	26,730,000	82.03	48,559,159	149.02	-21,829,159	-66.99
Oct	31	891,000	27,621,000	84.77	29,001,028	89.00	-1,380,028	-4.24
Nov	30	891,000	26,730,000	82.03	4,267,162	13.10	22,462,838	68.94
Dec	31	891,000	27,621,000	84.77	0	0.00	27,621,000	84.77
<b>Totals</b>			<b>325,215,000</b>	<b>998.05</b>	<b>406,913,639</b>	<b>1,248.77</b>		

Monthly Average Flow: 891,000

### Comparison of Average Monthly CLIBP Irrigation Water Demand and Recycled Water Production Rates.

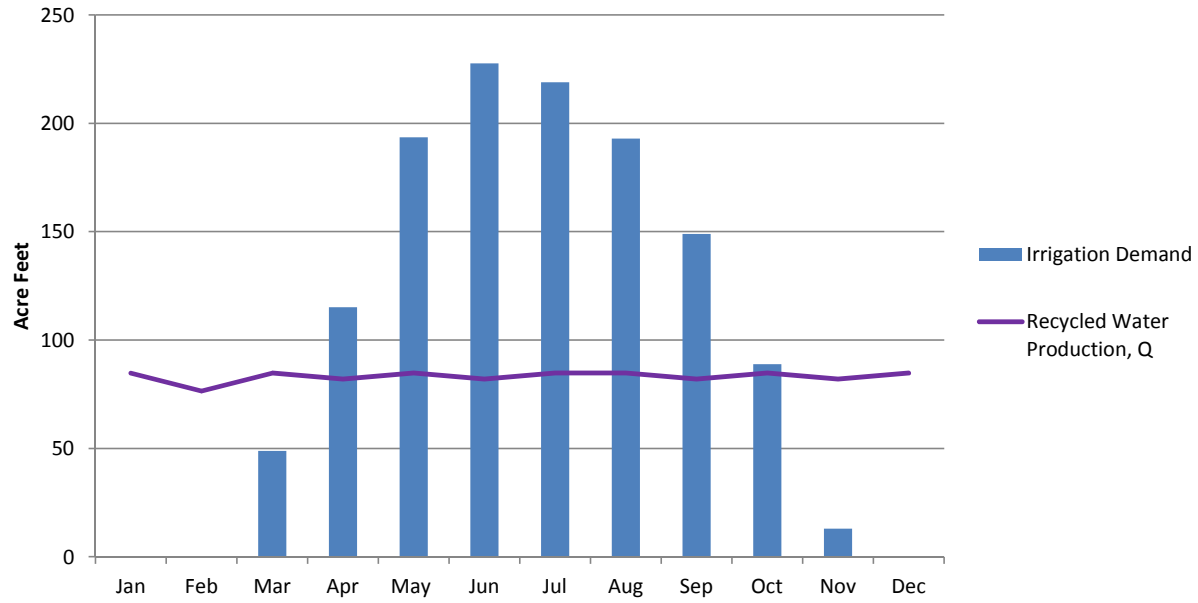


Table 7. Description of numbered water balance parameters and calculations for Tables 1 and 4.

Callout	Parameter or Label	Value or Calculation	Source or Narrative
(1)	Month	Varies	Calendar listing of months.
(2)	Reference Evapotranspiration, ET <sub>o</sub> (in/month)	Total ET <sub>o</sub> 58.60 in/year	Monthly average reference evapotranspiration (ET <sub>o</sub> ) from California Irrigation Management Information System (CIMIS) of California Department of Water Resources for Station 161, Patterson (Department of Water Resources,).
(3)	Precipitation Data Average Year Total Annual Precipitation (in/year)	Total Precipitation 11.81 in/year	Average annual precipitation for the nearby Modesto station (Western Regional Climate Center, accessed 2017). The precipitation data for each month is a percentage of the total precipitation for an average year. The precipitation data is available in the Appendix.
(3)	Precipitation Data 100-Year Total Annual Precipitation (in/year)	Total Precipitation 28.57 in/year (Assumed to have the same percentage of precipitation per month as average conditions)	100-year annual precipitation (annual rainfall with 0.01 probability of occurring in any given year) for the nearby Modesto station (Western Regional Climate Center, accessed 2017). The precipitation data is available in the Appendix.
(4)	Irrigation Hydraulic Loading Rate (ft/month)	$[(\mathbf{B}) \times (\mathbf{2}) - (\mathbf{3})] \times [1 + ((\mathbf{D}) / 100)] \times (100 / (\mathbf{C}))$	Irrigation is necessary when the rainfall does not meet the crop irrigation needs. The values of ET <sub>o</sub> can be converted into crop evapotranspiration by multiplying ET <sub>o</sub> (2) by the crop coefficient (B). This value is subtracted from precipitation (3) to calculate the net evapotranspiration. The irrigation efficiency (C) and leaching requirement (D) are estimated values and are shown in Table 8.
(5)	Irrigation Demand (AF/month)	(4) x (A)	The irrigation demand is calculated by multiplying the irrigation hydraulic loading rate (4) by the application area (A).

Table 8. Description of Lettered Water Balance Parameters.

<b>Callout</b>	<b>Parameter</b>	<b>Value</b>	<b>Source</b>
<b>(A)</b>	Irrigation Application Area (acres)	TBD	Acreage of landscape irrigation.
<b>(B)</b>	Crop Coefficient (unitless)	0.8	0.8 was used in the Crows Landing SB 601 Report-Appendix D City of Patterson Urban Management Plan (pdf pg 189 out of 473)
<b>(C)</b>	Irrigation Efficiency (percent)	70	Estimated based on <i>Guidelines for Water Reuse</i> (U.S. EPA, 2004). 70% Landscape irrigation efficiency used in the Modesto Irrigation District-2015 AWMP
<b>(D)</b>	Leaching Requirement (percent)	10	Estimated value based on irrigation demand. Reference from Stanislaus County. Leaching requirements vary by crop type, soil type, and other factors. The leaching requirement of 10 percent was assumed for this site based on the Modesto Irrigation District 2012 AWMP
<b>(E)</b>	Surface Area of Storage Basin (acres)	TBD	Crows Landing Industrial Business Park Sanitary Sewer Infrastructure and Facilities Study (AECOM and VVH Consulting Engineers, 2016).
<b>(F)</b>	Soil Infiltration Rate	<b>0.05-0.15 in/hr</b>  <b>0.5 in/hr</b>	Soil type C – Sandy clay loam. Infiltration rate when thoroughly wetted and consist primarily of soils with a layer that impedes downward movement of water as specified in the AECOM CLIBP Storm Drain Report.  Increased rate used for “engineered” percolation area

Table 9. Description of numbered water balance parameters and calculations for Tables 2 and 5.

Callout	Parameter or Label	Value or Calculation	Source or Narrative
(6)	Month	Varies	Calendar listing of months.
(7)	Days	Varies	Number of days in the month.
(8) and (9)	Recycled Water Production Average (gpd and AF/month)	Varies	Average Dry Weather Flows from the Crows Landing Industrial Business Park Sanitary Sewer Infrastructure and Facilities Study (2016).
(8) and (9)	Recycled Water Production 100-year (gpd and AF/month)	Varies	100-year monthly recycled water flows were estimated using the ratio of adjusted 100-year precipitation values to adjusted average precipitation values, and then multiplying the ratio by the average recycled water flow for each month.
(10)	Irrigation Demand (AF/month)	(4)x(A)	See Callout (5) in Table 7.
(11)	Change in Storage or Recycled Water (AF/month)	(9)-(10)	The change in storage is the difference between recycled water production (9) and irrigation demand (10), which is used to compare seasonal irrigation demand and the production of recycled water.

Table 10. Description of Numbered Water Balance Parameters and Calculations.

Callout	Parameter or Label	Value or Calculation	Source or Narrative
(12)	Month	Varies	Calendar listing of months.
(13)	Days	Varies	Number of days in the month.
(14)	Change in storage (AF/month)	(9)-(10)	See Callout (11) in Table 9.
(15)	Cumulative Storage (AF/month)	(14)+(15 from previous month)	To obtain cumulative storage volume for each month a running total is used by adding the previous month's storage (15) and the change in storage (14). The cumulative storage in this column does not consider precipitation or evaporation. The information in this column is used as an estimate to see when the lake is empty to assume no evaporation.
(16)	Precipitation Data Average Year Total Annual Precipitation (in/year)	Total Precipitation 11.81 in/year	See Callout (3) in Table 7.
(16)	Precipitation Data 100-Year Total Annual Precipitation (in/year)	Total Precipitation 24.10 in/year	See Callout (3) in Table 7.
(17)	Storage Basin	(2)x1	The lake evaporation can be estimated using ET <sub>o</sub> (2)



	Evaporation (in/month)		multiplied by the crop coefficient for a free water surface, which generally ranges from 1.05 to 1.15. Open water surface evaporation in California is 1.1 multiplied by $ET_o$ <b>(2)</b> (Department of Water Resources, 1999). A conservative estimate of 1.0 was used as the factor. When there is no recycled water in the storage basin, the value was set to zero.
<b>(18)</b>	Percolation/Seepage		Soil type C – Sandy clay loam as specified in the AECOM CLIBP Storm Drain Report.  Increased rate used for “engineered” percolation area
<b>(19)</b>	Net Gain or Loss in Storage Basin (AF/month)	$((14)-(15)) \times (E) - (18)$	To find the net gain or loss in storage volume, add the precipitation <b>(16)</b> and subtract the lake evaporation <b>(17)</b> . Multiply the calculated value by the application area <b>(E)</b> and subtract the seepage <b>(18)</b>
<b>(20)</b>	Irrigation Demand (AF/month)	$(4) \times (A)$	See Callout <b>(5)</b> in Table 7.
<b>(21)</b>	Change in Storage (AF/month)	$(9) + (16) - (20)$	The change in Storage can be estimated by adding the inflows and subtracting the outflows.
<b>(22)</b>	Cumulative Storage (AF/month)	$(19) + (20 \text{ from previous month})$	To obtain cumulative storage volume for each month a running total is used by adding the previous month’s storage <b>(22)</b> and the change in storage <b>(21)</b> .

## References

Asano, T. et al. 2007. *Water Reuse: issues, technologies, and applications*.

Department of Water Resources. 1999. California Irrigation Management Information System, Reference Evapotranspiration (ET<sub>o</sub>) Zones. <http://www.cimis.water.ca.gov/cimis/images/etomap.jpg>. Accessed April 15, 2011.

Geographic Information System. ArcGIS 10.0.

Pettygrove, G.S., and T. Asano. 1984. *Irrigation with Reclaimed Municipal Wastewater: A Guidance Manual*, Report Number 84-1 wr.

U.S. Environmental Protection Agency. 2004. *Guidelines for Water Reuse*.

Waste Discharge Requirements for the Bear Valley Community Services District Wastewater Treatment Plant Kern County. 2008. Order No. R5-2008-0121. NPDES No. CA0081213.

Western Regional Climate Center. Station: (048826) Tehachapi. <http://www.wrcc.dri.edu/index.html>.

# **DRAINAGE STUDY**

**FOR**

## **CROWS LANDING INDUSTRIAL BUSINESS PARK**

**Stanislaus County**

**Prepared by:**



**March, 2017  
Revised November, 2017**



# Table of Contents

EXECUTIVE SUMMARY .....	1
1. INTRODUCTION .....	2
2. HYDROLOGY .....	2
3. PROPOSED INFRASTRUCTURE.....	14
4. FLOODPLAIN MAPPING .....	19
5. GROUNDWATER RECHARGE.....	31
6. PHASING COSTS.....	31
7. CONCLUSIONS AND RECOMMENDATIONS .....	33

## List of Figures

Figure 1 - Existing Watershed Areas .....	3
Figure 2 - Soils Map .....	7
Figure 3 - HEC-HMS Existing Basin Model Schematic .....	10
Figure 4 - Proposed Watershed Areas .....	11
Figure 5 - HEC-HMS Proposed Basin Model Schematic.....	13
Figure 6 - Proposed Improvements.....	15
Figure 7 - Detention Pond 100-Year Inflow and Outflow Hydrographs .....	17
Figure 8 - FEMA Floodplain .....	21
Figure 9 - Existing Floodplain .....	22
Figure 10 - Floodplain Comparison .....	25
Figure 11 - Proposed FEMA Floodplain.....	29
Figure 12 – Phasing Map .....	32

## List of Tables

Table 1 - Existing Composite NRCS TR-55 Curve Numbers .....	9
Table 2 - Design Rainfall Data .....	9
Table 3 - Developed Composite NRCS TR-55 Curve Numbers .....	13
Table 4 - Hydrology Output (10, 100, and 500-Year, 24-Hour Storm Events).....	13
Table 5 - Stage-Storage-Discharge Curve .....	17
Table 6 - Preliminary Construction Cost Estimate for Backbone Infrastructure .....	18
Table 7 – Costs by Phase .....	33

This page intentionally left blank.

## **EXECUTIVE SUMMARY**

The proposed Crows Landing Industrial Business Park Project Site lies downstream of Little Salado Creek and receives runoff from an approximately 17 square mile area. A peak flow of 700 cubic feet per second (cfs) will be discharged from Little Salado Creek to the project site during a 100-year, 24 hour storm event. The peak discharge from the upstream tributary areas to the project site is controlled by the size of the existing double box culverts that convey the Little Salado Creek flow underneath the Delta Mendota Canal.

Under existing conditions, much of the runoff entering the proposed project site would pond against the California Northern railroad tracks, which are located across Highway 33 and adjacent to the northeastern corner of the site, and eventually flow towards the City of Patterson. The Marshall Drain has very little capacity, so any heavy storm would cause flooding on the site and in Patterson.

Improvements as part of the backbone infrastructure necessary for project development include widening the Little Salado Creek channel across the site and increasing the capacity of the culverts under the runway to carry the full 700 cfs discharge from Little Salado Creek to the northeast corner of the project site. Currently, a peak flow of approximately 250 cfs would reach this area. Other proposed improvements include full retention of flows from each leasehold site that will be developed in the future (not part of the backbone infrastructure) and raising of Davis Road west of the Delta Mendota Canal to block flows from ponding on that site.

To mitigate the increased flow that will be carried to the northeastern corner of the site, a multi-purpose detention pond will be constructed that will reduce the flows to equal to or below existing conditions and prevent impacts to the City of Patterson. This multi-purpose pond will have a capacity of 380 acre-feet and will be located near the Marshall Road and Crows Landing intersection with an estimated cost of \$7.71 million.

A Conditional Letter of Map Revision (CLOMR) should not be pursued at this time since only a small portion of the site is in the floodplain, and the project can be permitted without a CLOMR. Only a Letter of Map Revision (LOMR) would need to be processed after the improvements have been made. Since the proposed site includes an on-site airport, all proposed stormwater management facilities must be in accordance with FAA regulations and guidance pertaining to drainage proposed airport operations.

## 1. INTRODUCTION

The proposed Crows Landing Industrial Business Park project (Project) is a 1,528-acre planned development on the site of the former Crows Landing Air Facility. The project site lies west of State Route 33 and east of Interstate 5, southeast of the City of Patterson, and approximately 2 miles northwest of the community of Crows Landing. The Delta Mendota Canal traverses the southern portion of the Project in a northwest/southeast direction. Little Salado Creek enters the project site along the western property boundary slightly northeast of the Delta Mendota Canal and discharges to the Marshall Drain.

The Marshall Drain is an underground pipe near the intersection of Marshall Road and State Route 33 that carries runoff to the San Joaquin River approximately 4.3 miles east of the project site. The project site generally slopes northeasterly with an elevation change of approximately 80 feet, with the lowest elevation near the intersection of State Route 33 and Marshall Road. The site includes roads and aviation improvements associated with the former air facility, and approximately 1,200 acres of the site are currently used for agricultural purposes.

This study provides information required for the County to better assess the feasibility of the planned development by preliminarily defining the storm drain system infrastructure improvements necessary to accommodate planned development. The site's existing and proposed hydrological conditions were analyzed, and the existing and proposed 100-year floodplain was mapped. Proposed improvements are shown with estimated construction costs.

## 2. HYDROLOGY

### Existing Conditions

This section describes the existing conditions within the project site and surrounding Study Area, including topography, soils, existing drainage patterns, and the resulting runoff. The Study Area is the contributing watersheds as shown on Figure's 1 and 4.

Upstream watersheds east of Interstate 5 between the California Aqueduct and Delta Mendota Canal consist of land that generally slopes to the northeast. The terrain west of Interstate 5 is characterized by rolling hills and range land with elevations ranging from 220 feet to 1,400 feet.

Figure 1 shows the existing watershed areas. The areas are broken down as follows:

- Little Salado Creek Tributary Area: The approximately 6,925-acre watershed area west of Interstate 5, which is tributary to Little Salado Creek.
- Subshed 1: The approximately 236-acre watershed area situated between Interstate 5 and the California Aqueduct.
- Subshed 2: The approximately 1,046-acre watershed area situated between the Delta Mendota Canal and the California Aqueduct.
- Project Site: The approximately 3,036-acre watershed area includes the 1,528-acre Subshed 3, which is the Project Site, and the surrounding area that extends from the Delta Mendota Canal to State Route 33.



**Figure 1 - Existing Watershed Areas**

This page intentionally left blank.

Storm runoff from the Little Salado Creek watershed west of the California Aqueduct crosses both Interstate 5 and the California Aqueduct. From that point, runoff flows toward the Delta Mendota Canal while collecting runoff from Subshed 1. Subshed 2 drains that area between the California Aqueduct and the Delta Mendota Canal. Flow is conveyed under the Delta Mendota Canal by two, 5-foot-square box culverts that have capacity for only 700 cfs. This crossing is the only direct drainage connection to the project site from watershed areas to the west of the Delta Mendota Canal.

On the east side of the Delta Mendota Canal, the box culverts drain into an open channel that continues in a northeasterly direction through the project site, crossing through the culverts beneath the runways. The open channel ultimately drains toward the low point of the project site near the intersection of State Route 33 and Marshall Road. At this low point, runoff drains through a linear sedimentation basin towards a raised concrete control structure. The control structure contains a 24-inch outlet controlled by a slide-gate valve.

The 24-inch outlet discharges to the 24-inch “Marshall Drain”, which runs parallel to Marshall Road for approximately 4.3 miles to its final discharge point at the San Joaquin River. Excess stormwater runoff is known to accumulate in the northeast portion of the project site, primarily a result of limited discharge capacity within the 24-inch Marshall Drain Line. Appendix A contains photos of the Little Salado Creek as it crosses the project site. During heavy rainfall events, runoff pools against the railroad tracks, eventually over-tops the railroad, and then flows northwesterly towards the San Joaquin River. In addition, flows migrate north towards the City of Patterson and contribute to flooding in that area.

Peak discharges and runoff volumes from the project site and off-site watersheds were determined using the NRCS Technical Release 55 (TR-55) and the Hydrologic Modeling System (HEC-HMS) software, Version 4.0, developed by the United States Army Corps of Engineers (USACE) Hydrologic Engineering Center (HEC). This section provides a brief summary of the input parameters used in the analysis.

Soils were classified according to ratings determined by the United States Department of Agriculture’s Natural Resources Conservation Service (NRCS). The NRCS classifies soils into four Hydrologic Soil Groups based on the soil’s runoff potential (NRCS TR-55):

- **Group A** soils are sand, loamy sand, or sandy loam. These soils have low runoff potential and high infiltration rates (greater than 0.30 inches per hour [in/hr]) even when thoroughly wetted. They consist chiefly of deep, well to excessively drained sands or gravels, and have a high rate of water transmission.
- **Group B** soils are silt loam or loam. These soils have moderate infiltration rates (0.15 – 0.30 in/hr) when thoroughly wetted and consist primarily of moderately drained soils with moderately fine to moderately coarse textures.
- **Group C** soils are sandy clay loam. These soils have low infiltration rates (0.05 – 0.15 in/hr) when thoroughly wetted and consist primarily of soils with a layer that impedes downward movement of water and soils with moderately fine to fine structure.
- **Group D** soils are clay loam, silty clay loam, sandy clay, silty clay, or clay. These soils have the highest runoff potential and very low infiltration rates (0.0 – 0.05 in/hr) when thoroughly wetted. They consist primarily of clay soils with a high swelling potential and/or soils with a permanent high water table.

The off-site Little Salado Creek drainage area soils range from Type C to Type D. Type C is the predominant soil type, accounting for 72 percent of the soils. See Figure 2 for a soils map of the Study Area.

This page intentionally left blank.

**Figure 2 - Soils Map**

This page intentionally left blank.

Composite Curve Numbers (CNs) were used per TR 55 to estimate runoff from the watershed areas. These CNs are characterized and determined by the cover type, treatment and soil conditions within a given watershed. Composite CNs for the project site and off-site tributary areas were determined using the soils information shown in Figure 2, and weighted based on the acreage of the particular soil type within a given watershed.

Composite CNs for the tributary areas are summarized below in Table 1.

**Table 1 - Existing Composite NRCS TR-55 Curve Numbers**

<u>Watershed</u>	<u>Area (sq. mi.)</u>	<u>Composite CN</u>
Little Salado Creek	10.8	83
Subshed 1	0.4	82
Subshed 2	4.1	82
Project Site	4.4	84

Design storm events are described in terms of depth, duration, and frequency of occurrence. The 100-year, 24-hour storm event was selected as the design storm for this analysis. The 10-year and 500-year storm events were also analyzed in case a FEMA CLOMR is pursued. The depths for the re-occurrence intervals were taken from the Stanislaus County Drainage Design Standards and are shown in Table 2.

**Table 2 - Design Rainfall Data**

<b>Design Storm Frequency</b>	<b>24-Hour Rainfall (inches)</b>
10-year	2.03
100-year	3.13
500-year	4.02

The rainfall distribution used was the NRCS Type I rainfall distribution. Figure 3 shows the HEC-HMS schematic of the existing conditions model developed for this analysis.

**Figure 3 - HEC-HMS Existing Basin Model Schematic**

Stage-storage discharge curves were developed for hydraulic structures, such as culverts and over-chutes, and were utilized to determine runoff attenuation behind the California Aqueduct and Delta Mendota Canal. Significant ponding occurs behind the embankments of these canals. The hydraulic stage versus discharge curves were developed using HEC-RAS using a series of flows. The resulting water surface elevations were used to measure the storage volumes at those elevations.

Under existing conditions, the channel crossing the site does not have the capacity to carry all the runoff entering the site. In addition, the culverts under the existing runway are inadequate to carry the runoff.

Proposed Conditions

Development of the project site will require the construction of storm drainage infrastructure to accommodate the off-site runoff from upstream tributary areas. Following the construction of storm drainage infrastructure, the significant amount of runoff that would currently pond on the site will be routed through the site, resulting in much larger peak flows. By requiring all future leasehold development to retain all runoff on site, additional peak flows from the site are not anticipated and the HMS modeling reflects this.

Figure 4 shows the proposed drainage areas, which are the same as the existing conditions except that the on-site areas have been modified to reflect the proposed development.



**Figure 4 - Proposed Watershed Areas**

This page intentionally left blank.

Runoff curve numbers were updated for the proposed conditions and are shown in Table 3.

**Table 3 - Developed Composite NRCS TR-55 Curve Numbers**

<u>Watershed</u>	<u>Area (sq. mi.)</u>	<u>Composite CN</u>
Little Salado Creek	10.8	83
Subshed 1	0.4	82
Subshed 2	3.9	82
Subshed 3	1.6	84
Subshed 4	0.7	84
Project Site 1	2.3	94.3
Project Site 2	0.2	94.2

Figure 5 shows the proposed condition HEC-HMS model configuration.

**Figure 5 - HEC-HMS Proposed Basin Model Schematic**

Results

The HEC-HMS model results for the existing and proposed conditions are shown in Table 4

**Table 4 - Hydrology Output (10, 100, and 500-Year, 24-Hour Storm Events)**

Element	10-Year Event		100-Year Event		500-Year Event	
	Existing	Proposed	Existing	Proposed	Existing	Proposed
	Peak Discharge (cfs)	Peak Discharge (cfs)	Peak Discharge (cfs)	Peak Discharge (cfs)	Peak Discharge (cfs)	Peak Discharge (cfs)
Little Salado Creek Shed	941	941	2,312	2,312	3,560	3,560
Subshed 1	30	30	78	78	122	122
J2	971	971	2,389	2,389	3,681	3,681
Little Salado CA AQ Culvert	839	839	1,383	1,383	1,667	1,667
Little Salado from CA to DMC	839	839	1,383	1,383	1,667	1,667
Subshed 2	87	76	217	191	338	297
J3	925	909	1,584	1,573	1,966	1,953
Project 2	N/A	38	N/A	60	N/A	84
Retention Basin 2	N/A	0	N/A	0	N/A	16
Little Salado DMC Culvert	676	675	700	700	700	700
Little Salado Creek	675	675	700	700	700	700
Little Salado Overtopping	250	N/A	250	N/A	250	N/A
J5	425	796	450	1,056	450	1,245
Project 1	N/A	937	N/A	1,532	N/A	2,102
Retention Basin 1	N/A	0	N/A	0	N/A	144
Subshed 3	276	113	607	264	905	401
Subshed 4	N/A	42	N/A	97	N/A	148
OnSiteDetention	N/A	357	N/A	784	N/A	923
Patterson Diversion <sup>2</sup>	515	347	846	773	1,144	912
24 inch pipe <sup>2</sup>	8	11	8	11	9	11

1 Those elements with N/A did not exist in the Existing Condition or were eliminated in the Proposed Condition.

2 These are locations where flows are leaving the project site

Under existing conditions, the peak, 100-year discharge on Little Salado Creek at the California Aqueduct is 2,312 cfs. The peak discharge through the culvert and into Subshed 2 is 1,383 cfs due to flood attenuation behind the California Aqueduct. The peak discharge reaching the Delta Mendota Canal culverts are 1,584 cfs, which is then attenuated to 700 cfs through the Delta Mendota Canal culverts. Flows in excess of this amount would pool west of the Delta Mendota Canal and eventually overtop the Delta Mendota Canal.

Under proposed conditions, Little Salado Creek across the project site will have the capacity to convey the full 700 cfs across the site. This eliminates the pooling along the railroad tracks to the east, however, peak flows flowing north towards Patterson would be increased without mitigation. Under proposed conditions, this increase in flow will be mitigated by developing a detention pond on the northeast corner of the site. Under existing conditions, approximately 850 cfs (100-year event) would flow towards Patterson. Without mitigation, this discharge would be increased to nearly 1,050 cfs. During a 10-year event, the increase is even greater (270 cfs) and, therefore, controls the amount of reduction in peak flows that must be achieved. Therefore, the detention pond must reduce this peak flow by approximately 270 cfs to prevent adverse effects on the City of Patterson.

### **3. PROPOSED INFRASTRUCTURE**

For the purposes of this study, it has been assumed that all future, private development will be required to retain up to the 100-year event on-site. This requirement will greatly reduce the amount of runoff to be conveyed or detained downstream and, therefore, greatly reduces the amount of drainage infrastructure that is required for this development.

New backbone drainage infrastructure will be required to enable subsequent on-site development. Two infrastructure items are common to the alternatives discussed in this section:

- Raising Davis Road by approximately 4 feet to protect the area west of the Delta Mendota Canal and
- Increasing the capacity of Little Salado Creek by widening the channel and increasing the culverts capacity under the runway. Off-site flows would be conveyed through the site via the expanded open channel and culverts to the northeast corner of the project.

See Figure 6 for the area of Little Salado Creek affected by the proposed improvements described in this document.

Based on their proximity to existing runway infrastructure, the design of the channels will need to address guidance set forth in FAA orders and guidance. FAA Order 13, Design, provides guidance for drainage facilities constructed on Airports. FAA AC 150/5200-33B, "Wildlife Hazard Attractants on and Near Airports," provides guidance for open water facilities constructed within the critical zone for wildlife hazards, which is defined as the area 10,000 feet of aircraft movement areas and within 5 miles of approach departure areas. The following design criteria will apply:

- The portion of the on-site channel between runway pavements and the Ike Crow Road Extension must remain underground, as no open water can be constructed within the airport fence.
- The sides of the on-site channel must include steep slopes and armoring (rather than vegetation) to make them less attractive to wildlife.
- None of the proposed on-site channels will include features that provide habitat for flora or fauna.

**Figure 6 - Proposed Improvements**

This page intentionally left blank.

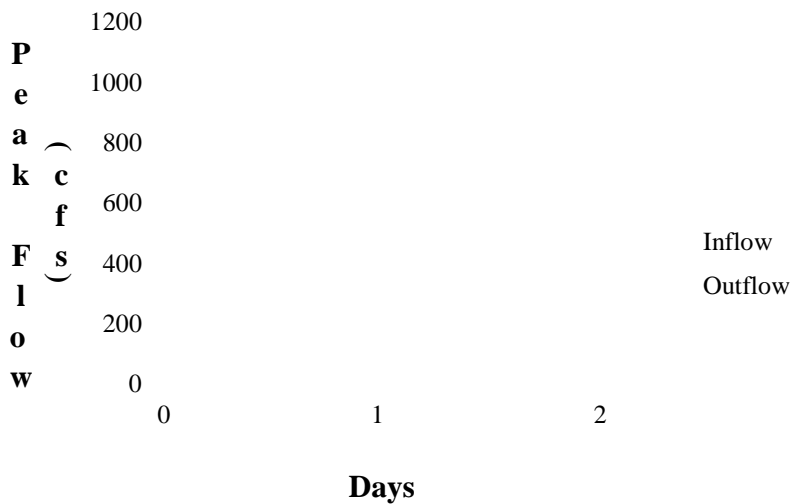
On-site Detention/Storage

A detention pond would be constructed in the northeast portion of the project site to detain flows to so no increase in the peak flows above existing conditions will occur. In the HEC-HMS model the peak flows from Junction J5 were routed through the detention pond with an outflow restriction at the downstream end which will limit peak flows to less than the maximum allowable rates (existing conditions peak flows). A stage-storage-discharge rating curve, as shown in Table 5, was developed to model the proposed pond. Based on this model, the pond would require a capacity of approximately 180 acre-feet and cover an area of approximately 40 acres. In addition, this pond will have capacity to retain up to a 2-year storm event in the bottom of the pond. This additional 200 acre-feet of “dead” storage will be retained to allow groundwater recharge as described in the Groundwater section of this report.

**Table 5 - Stage-Storage-Discharge Curve**

<b>Elevation (ft)</b>	<b>Storage (Acre-Feet)</b>	<b>Flow (cfs)</b>
110.5	0	0
115	198	0
116	244	95
117	290	275
118	337	530
119	384	790
120	432	950

Figure 6 shows a layout for the proposed detention pond. Figure 7 shows the peak inflow and outflow hydrographs for the proposed detention pond.



**Figure 7 - Detention Pond 100-Year Inflow and Outflow Hydrographs**

Table 6 below provides an estimated cost for the backbone infrastructure.

**Table 6 - Preliminary Construction Cost Estimate for Backbone Infrastructure**

**Phase 1A**

<b>ITEM NO.</b>	<b>DESCRIPTION OF WORK</b>	<b>QUANTITY</b>	<b>UNIT</b>	<b>UNIT PRICE</b>	<b>TOTAL</b>
1	Davis Road Raise	1	LS	\$225,250	\$225,250
				Subtotal:	\$225,250
				25%	\$56,313
				Contingency:	
				Total	\$281,563

**Phase 1b**

<b>ITEM NO.</b>	<b>DESCRIPTION OF WORK</b>	<b>QUANTITY</b>	<b>UNIT</b>	<b>UNIT PRICE</b>	<b>TOTAL</b>
1	On-Site Channel Earthwork	40,000	CY	\$10	\$400,000
2	Detention Basin Earthwork	368,807	CY	\$5	\$1,844,035
3	Detention Basin Inlet/Outlet Works	1	EA	\$50,000	\$50,000
4	Infiltration Trenches	16,791	CY	\$25	\$419,780
5	Triple 4 by 8 Box Culverts	2,085	LF	\$800	\$1,668,000
6	Headwalls	2	EA	\$25,000	\$50,000
				Subtotal:	\$4,431,815
				25%	\$1,107,954
				Contingency:	
				Total	\$5,539,768

**Phase 2**

<b>ITEM NO.</b>	<b>DESCRIPTION OF WORK</b>	<b>QUANTITY</b>	<b>UNIT</b>	<b>UNIT PRICE</b>	<b>TOTAL</b>
1	Detention Basin Earthwork	113,925	CY	\$5	\$569,623
2	Infiltration Trenches	5,187	CY	\$25	\$129,670
				Subtotal:	\$699,294
				25%	\$174,823
				Contingency:	
				Total	\$874,117

**Phase 3**

<b>ITEM NO.</b>	<b>DESCRIPTION OF WORK</b>	<b>QUANTITY</b>	<b>UNIT</b>	<b>UNIT PRICE</b>	<b>TOTAL</b>
1	Detention Basin Earthwork	132,268	CY	\$5	\$661,342
2	Infiltration Trenches	6,022	CY	\$25	\$150,549
				Subtotal:	\$811,892
				25%	\$202,973
				Contingency:	
				Total	\$1,014,865



FAA warns against the construction of open water ponds within 10,000 feet of aircraft movement areas. Based on the pond's proximity to the airport, the pond will be designed and constructed in accordance with guidance set forth in FAA Advisory Circular 150/5200-33B. Applicable design considerations will include the use of steep slopes and armoring. FAA guidance also states that open water features drain within 48 hours of a 10-year storm event.

#### **4. FLOODPLAIN MAPPING**

##### Existing Conditions

The FEMA defined floodplain as shown on Figure 8 shows Zones A (100-year no elevations determined) and X (500-year or 100-year with depths less than one-foot) on the project site. Zone X areas do not require LOMR's or flood insurance. This floodplain information is based on FEMA Panel 06099C0765E, effective date September 26, 2008.

It appears that the Zone A defined area is incorrectly mapped because the limits shown do not correlate to any topographic features. Figure 8 shows the existing conditions 100-year floodplain limits determined as part of this study.

Approximate A Zones are those areas not studied by the detailed hydrologic/hydraulic methods. FEMA allows the County Floodplain Manager to allow development in A Zones if base flood elevations have been determined and the development is outside the limits of the 100-year floodplain. Since we have determined the base flood elevations will be contained within the channel in this area, no CLOMR is necessary for this development. Eventually, a LOMR will need to be processed for the area currently in FEMA Zones A and X, so the development on this portion of the project will not be subject to flood insurance.

As part of this study we also determined peak flows on Salado Creek to investigate the possibility that runoff from that watershed were combining with runoff from Little Salado Creek to create a larger floodplain as shown on the FEMA panel. The results of this analysis show that the over-chute across the Delta Mendota Canal that carries runoff from Salado Creek towards Patterson would only pass 112 cfs during a 100-year event. Therefore, it does not appear that flows from Salado Creek are traveling south to Little Salado Creek.

Raising Davis Road will protect that portion of the project south of the DMC from flooding but will cause more area to the west of Davis Road to be inundated during large flood events. The inundation will be deeper than under current conditions, however, the duration will be short. The existing floodplain west of the DMC is not currently mapped by FEMA so no letter of map change will be required as part of this development. In the future, if the area west of Davis Road is mapped by FEMA it would probably be categorized as a Zone A or AE.

This page intentionally left blank.

**Figure 8 - FEMA Floodplain**

**Figure 9 - Existing Floodplain**

The limits of the 100-year floodplain were determined for the existing conditions by developing a one-dimensional hydraulic model using HEC-RAS. The existing conditions model simulates a 100-year flood event using hydrologic inputs from HEC-HMS that incorporate flood flows that enter Little Salado Creek from the Delta Mendota Canal culvert. During a 100-year storm event Little Salado Creek would experience overtopping at locations where the channel is too narrow and at the culverts conveying flow under the existing airstrip.

To determine the limits of the floodplain, stream and overbank cross sections were developed at intervals sufficient to adequately characterize the flow carrying capacity of the stream and overbanks. AECOM developed cross sections from a topographic survey by the United States Geologic Survey (National Elevation Dataset) augmented by GPS survey points collected during field visits. These additional points were taken at culvert crossings, along the existing channel, and at select roads and railroad locations. These cross sections were used to create the geometry file for the existing conditions floodplain analysis.

At each cross section, Manning's coefficients were used to define the roughness of the channel and bank. Manning's values of 0.045 for the channel and overbanks were selected based on USGS recommendations (USGS, 1967), site visits, and site photographs.

In addition to the geometry data file, a HEC-RAS flow file was developed for the unsteady-state flow simulation. An unsteady flow model was required because over-flowing of the channel would occur and the ground continues to slope away from the channel on the right bank. A steady-state model would not allow us the ability to "capture" this flow. An unsteady model allowed us to do this by modeling lateral weirs to allow simulation of the overflowing of the right bank of the on-site channel. The beginning downstream boundary condition was based on the HEC-HMS simulation results.

Appendix E includes existing condition simulation results in the form of cross sections, profiles, and tabulated hydraulic computations. The limits of the existing floodplain matched relatively well with the FEMA defined floodplain as shown on Figure 10.

This page intentionally left blank.

**Figure 10 - Floodplain Comparison**

This page intentionally left blank.



Once water overtops the embankments of the Little Salado Creek it flows northeast until reaching the railroad tracks east of Highway 33. Once the ponding is deep enough, flows both overtop the railroad tracks (flowing northeast east towards the San Joaquin River) and Marshall Road flowing northerly to Patterson.

#### Proposed Conditions

A hydraulic model was used to simulate the 100-year storm with the project site developed and improvements complete. The model includes hydrologic inputs from HEC-HMS that incorporate site runoff from developing the project area and flood flows that enter Little Salado Creek from the Delta Mendota Canal culvert. In the model the flood flows were conveyed without overtopping Little Salado Creek by widening the channel, reducing vegetation to increase the capacity and reflect better maintenance, and increasing the capacity of the culverts under the runway. The proposed floodplain is shown on Figure 11.

This page intentionally left blank.

**Figure 11 - Proposed FEMA Floodplain**

This page intentionally left blank.

## 5. GROUNDWATER RECHARGE

To determine the amount of additional recharge into the shallow aquifer, AECOM utilized average annual discharge at gaging stations on Orestimba and Del Puerto Creeks provided by Jacobson-James and Associates, Inc. The following table shows the results of flow gage records for Del Puerto and Orestimba Creeks:

<b>Watershed</b>	<b>Size (mi<sup>2</sup>)</b>	<b>Average Discharge (acre-ft/year)</b>	<b>Discharge Per mi<sup>2</sup> (acre-ft/year)</b>
Del Puerto Creek	73	5,107	70
Orestimba Creek	134	12,348	92
Salado, Little Salado, and Crow Creek	67	5,444	81
<b>Total</b>	<b>274</b>	<b>22,899</b>	

The estimated discharge near the mountain front from the watersheds of Salado, Little Salado, and Crow Creeks was estimated by taking the average per acre discharge from the other two watersheds and multiplying by the estimated combined area of these watersheds. For little Salado Creek, the calculated average annual discharge using this approach would be 81 acre-ft/year/square mile x 10.8 square miles = 874 acre-ft/year.

Since the goal is to eventually produce up to 489 acre-feet/year a method of capturing and infiltrating this runoff was developed. A proposed dual purpose stormwater pond will be constructed to both infiltrate and detain runoff from Little Solado Creek along Bell Road south of Marshall Road. This pond will have a total capacity of 380 acre-feet; 200 acre-feet of retention storage (for infiltration) in the bottom and 180 acre-feet of detention storage above that. The 200 acre-feet is based on the volume of a 2-year storm which has a 50% chance of being exceeded in any given year. The 180 acre-feet is the necessary volume to attenuate flows downstream. This additional depth of 5-feet in the pond cannot flow out of the pond except by infiltration.

The runoff into the multi-purpose stormwater pond must be drawn down in 48 hours or less due to its proximity to the airplane runway. The existing soils in the area of the multi-purpose stormwater pond (primarily hydrologic soil group C), which tend to not infiltrate quickly, cannot draw down the pond in 48-hours. Therefore, about 20% of the pond bottom will have to be improved to allow infiltration by adding a 24-inch layer of ¾" crushed rock that allows an infiltration rate of ½" per hour.

NOTE: If the County selects an on-site wastewater treatment alternative, one option will be to discharge highly treated effluent to the stormwater pond for infiltration into the upper aquifer. This would require a reevaluation of the area of pond bottom that would receive engineered improvements to enhance infiltration, which could exceed 20% of the pond bottom. This on-site treatment alternative is discussed in the CLIBP Wastewater Master Plan.

## 6. PHASING COSTS

The overall cost for the backbone infrastructure has been broken-out by phase based on the proposed phasing shown on Figure 12. The proposed detention basin can be constructed in phases starting with Phase 1. Table 7 gives a summary of costs per phase.

**Figure 12 – Phasing Map**

**Table 7 – Costs by Phase**

Phase 1A	Phase 1B	Phase 2	Phase 3	Total
\$281,563	\$5,539,768	\$874,117	\$1,014,865	\$7,710,313

## **7. CONCLUSIONS AND RECOMMENDATIONS**

Under existing conditions, significant runoff would pond behind the California Aqueduct and then the Delta Mendota Canal, which significantly reduces peak flows reaching the project site. The existing culverts under the runway and the Little Salado Creek channel downstream of the runway do not have capacity to carry the peak flows reaching this area. The Marshall Drain has virtually no capacity. The result is ponded runoff on the project site and eventually runoff is diverted towards Patterson.

Improvements to on-site infrastructure must be made prior to and during leasehold development. All new leasehold development will be required to provide full retention of the 100-year event on-site which will substantially reduce the amount of new runoff due to impervious surfaces. The capacity of the existing culverts that pass beneath the runway must be increased, and the Little Salado channel must be improved. Following these improvements, much more flow will reach the Marshall Drain, and much more runoff would be diverted towards Patterson. To mitigate this increase, either a detention pond or new channel must be constructed.

Prior to any new development, additional design of these improvements needs to be completed and this analysis updated to match the planned improvements. The recommendations in this report are based on preliminary sizing of improvements which in turn are based on preliminary topographic information.

In addition, further topographic survey information for that area between the Delta Mendota Canal and California Aqueduct are recommended to better assess the ponding that would occur from Little Salado and Salado Creek flows that would pond behind the Delta Mendota Canal.

It is not recommended that a CLOMR be pursued at this time. Since only a small portion of the site is in the floodplain and the project can still be permitted without a CLOMR, only a LOMR would have to be processed after the improvements have been made. In addition, since the area west of the Delta Mendota Canal is not shown to be in the floodplain when it should be, processing a CLOMR for this area may be detrimental to the project. The raising of Davis Road west of the Delta Mendota Canal would block runoff from ponding on the project site and allow development on that parcel. However, obtaining FEMA approval for what would essentially act as a levee would require full designs of the road for submittal to FEMA. If Stanislaus County decides to pursue a CLOMR, additional topographic surveys, soils analysis, and design plans would have to be prepared to support the CLOMR.

This page intentionally left blank.



**CROWS LANDING INDUSTRIAL BUSINESS PARK**

**DRY UTILITIES INFRASTRUCTURE AND FACILITIES  
STUDY**



Prepared for:  
Stanislaus County  
1010 10<sup>th</sup> Street  
Modesto, CA 95354  
(209) 525-4130

Prepared by:  
VVAH Consulting Engineers  
126 Drake Avenue  
Modesto, CA 95350  
(209) 568-4477

February 6, 2015

**Table of Contents**

**1.0 INTRODUCTION ..... 1**  
 1.1 STUDY PURPOSES AND OBJECTIVES ..... 1  
 1.2 STUDY AREA ..... 1

**2.0 BACKGROUND INVESTIGATION..... 2**  
 2.1 EXISTING DRY UTILITIES ..... 2  
 2.1.1 ELECTRICITY ..... 2  
 2.1.2 COMMUNICATIONS ..... 2  
 2.1.3 NATURAL GAS ..... 3

**3.0 PROPOSED INFRASTRUCTURE ..... 3**  
 3.1 ELECTRICITY ..... 3  
 3.2 COMMUNICATIONS ..... 3  
 3.3 NATURAL GAS ..... 3  
 3.4 COST ESTIMATE ..... 4

**LIST OF FIGURES**

Figure 3.1 Dry Utilities Map



## 1.0 INTRODUCTION

Section 1 states the study background and purposes, Study Area, and overall system planning assumptions.

### 1.1 STUDY PURPOSES AND OBJECTIVES

The Crows Landing Industrial Business Park project (Project) is an approximately 1,532-acre conceptually planned development that encompasses the reuse of the former Crows Landing Air Facility, which was decommissioned by NASA in the late 1990s, as shown in Figure 3.1.

A plan for a practical and highly reliable dry utilities infrastructure system is an essential component of the Crows Landing Industrial Business Park. The scope of this study is to identify the major infrastructure elements required to provide sufficient electric, communications, and gas services to the development. The findings of this study are based on available information and are subject to change once more detailed engineering analyses are performed as the Project progresses.

### 1.2 STUDY AREA

The Project addresses the reuse of the former Crows Landing Air Facility, encompassing approximately 1,532 acres in the western portion of Stanislaus County, west of State Route 33 and east of Interstate 5, southwest of Patterson, and approximately 1 mile west of the unincorporated community of Crows Landing (Figure 3.1). The Project is bounded on the east by Bell Road, on the south by Fink Road, on the west by Davis Road, and on the north by Marshall Road and State Route 33. The Delta-Mendota Canal traverses the southern portion of the Project in a northwest/southeast direction. Little Salado Creek enters the Project site along the western property boundary slightly northeast of the Delta-Mendota Canal and terminates near the intersection of Marshall Road and State Route 33. The Project site topography generally slopes down in a northeasterly direction with an elevation change of approximately 80 feet, with the lowest elevation near the intersection of State Route 33 and Marshall Road. The site includes vehicle and aviation improvements associated with the former air facility which are currently being leased for agricultural use.

## 2.0 BACKGROUND INVESTIGATION

Section 2 discusses existing dry utilities infrastructure.

### 2.1 EXISTING DRY UTILITIES

Some extendable dry utilities exist in the vicinity of the Project. Each of these is discussed in turn in the following sections.

#### 2.1.1 ELECTRICITY

The Turlock Irrigation District (TID), established in 1887, was the first publicly owned irrigation district in the state. TID serves a population of approximately 220,000 people throughout a 662-square-mile service area. The service area includes northern Merced County, and southern Stanislaus County and small sections of Tuolumne and Mariposa counties. TID is capable of generating slightly more than 505 megawatts (MW) of electricity with internal resources. The district's power generation sources include hydroelectric, geothermal, and fossil fuel power plants.

TID currently serves the Project area with a number of overhead facilities. A TID substation is located at the northeast corner of Marshall Road and Davis Road. This substation is fed from a double circuit 115 kilovolt (kV) line with a 12kV underbuild located along Marshall Road on the northern boundary of the Project site.

TID representatives state that capacity exists to serve the Project but that electrical distribution infrastructure would need to be constructed in order to do so. TID cannot estimate the required infrastructure nor the costs until such time as an application for service is made for the Project.

#### 2.1.2 COMMUNICATIONS

AT&T Inc. (AT&T, formerly SBC Communications) is the largest telecommunications company in the world (by revenue) with more than 100 million customers. The company serves customers with a concentration in 22 states: Alabama, Arkansas, California, Connecticut, Florida, Georgia, Illinois, Indiana, Kansas, Kentucky, Louisiana, Michigan, Mississippi, Missouri, Nevada, North Carolina, Ohio, Oklahoma, South Carolina, Tennessee, Texas, and Wisconsin. AT&T delivers a range of wireless voice and data services to customers across the United States as well as globally. AT&T is the nation's largest wireless carrier, based on subscribers, with 63.7 million users, and spectrum licenses in all 50 states, the District of Columbia, Puerto Rico, and the U.S. Virgin Islands. Furthermore, AT&T's wireless unit is expanding the company's ability to provide a range of innovative and flexible solutions that integrate wireless and wire line communications.

Global Valley Networks (GVN), based in Patterson, California, provides telephone and Internet services to the communities of Patterson, Livingston, Guinda, San Antonio, Diablo Grande, Westley, Cressey, Grayson, and Capay Valley, California. GVN was established in 1913 to meet the need for basic telephone service in the community of Patterson, California.

Both AT&T and Global Valley Networks currently provide telephone communications in the Project area.



Comcast Corporation (Comcast) was founded in 1963 and is the largest provider of cable and home internet services in the country, providing these services and voice services to residential and commercial customers in 40 states and the District of Columbia. Comcast serves 21.7 million customers.

No cable television service is currently available in the Project area.

### 2.1.3 NATURAL GAS

Pacific Gas and Electric (PG&E), incorporated in California in 1905, is one of the largest combination natural gas and electric utilities in the United States. The company provides natural gas and electric service to approximately 15 million people throughout a 70,000-square-mile service area in northern and central California. The company's service area stretches from Eureka in the north to Bakersfield in the south, and from the Pacific Ocean in the west to the Sierra Nevada in the east.

PG&E currently has a 24-inch diameter transportation pipeline on the northern boundary of the Project area and a 3-inch diameter gas distribution pipeline running from Interstate 5 along the southern boundary of the Project area serving the community of Crows Landing. No gas service is currently available within the Project area.

## 3.0 PROPOSED INFRASTRUCTURE

Section 3 discusses proposed dry utilities infrastructure. Attached is a proposed dry utility layout and joint trench detail (Figure 3.1).

### 3.1 ELECTRICITY

TID will require 15 to 20 feet in width for a public utility easement to accommodate facilities. Manholes will be required every 800 feet for underground facilities, which will include 4-inch and 6-inch diameter conduits. Pad-mounted switchgear and pad-mounted capacitor banks could be required but the TID cannot estimate infrastructure requirements at this time.

### 3.2 COMMUNICATIONS

Both AT&T and Global Valley Networks state that they will provide telephone services to the Project. Manholes will be required every 600 feet for underground facilities, which will include 4-inch diameter conduits for telecommunication cable distribution.

Comcast will require an extension of their existing fiber optic cable from the Crows Landing community in order to provide service to the Project. Underground facilities will include 2-inch diameter conduit and manholes for cable television distribution.

### 3.3 NATURAL GAS

Pacific Gas and Electric (PG&E) has yet to answer inquiries regarding gas service to the Project.

3.4 COST ESTIMATE

The specific dry utility needs and service requirements will vary depending on the specific uses and demands of the individual developments. While the specific uses are unknown at this time, an “order of magnitude” estimated cost for onsite dry utility service can be determined using reasonable judgment and assumptions. It is assumed that all dry utilities, including electricity, gas, telephone and cable, will be conveyed through the major backbone streets in a “joint trench”. Costs presented below do not include offsite utility improvements to bring dry utility services to the Project site. A typical detail of a joint trench is shown on Figure 3.1. Estimated costs for dry utilities to serve the Project are estimated on a lineal foot basis as shown in Table 1 below:

**Table 1 Estimated Onsite Dry Utility Construction Costs**

Description	Quantity	Unit	Unit Price	Cost
Joint Trench – Phase 1A	6,014	LF	\$200	\$120,280
Joint Trench –Phase 1B	7,660	LF	\$200	\$1,532,000
Joint Trench –Phase 2	23,004	LF	\$200	\$4,600,800
Joint Trench –Phase 3	25,265	LF	\$200	\$5,053,000

CROWS LANDING INDUSTRIAL BUSINESS PARK  
DRY UTILITIES INFRASTRUCTURE AND FACILITIES STUDY  
FEBRUARY 6, 2015

Figure 3.1 Crows Landing Industrial Business Park – Dry Utilities Map





# **Crows Landing Industrial Business Park**

## **Financing Plan**

**Revised DRAFT**

**November 30, 2016**



# TABLE OF CONTENTS

	PAGE
1. INTRODUCTION .....	1
2. PROJECT DESCRIPTION.....	5
2.1. Crows Landing Industrial Business Park (CLIBP) Overview .....	5
2.2. CLIBP Proposed Land Uses .....	6
3. INFRASTRUCTURE AND PUBLIC FACILITY REQUIREMENTS .....	9
3.1. Backbone Infrastructure Definition .....	9
3.2. Backbone Infrastructure/Public Facilities Costs .....	9
3.3. Transportation.....	11
3.4. Water Supply and Distribution .....	12
3.5. Wastewater Collection and Treatment .....	13
3.6. Stormwater Management .....	13
3.7. Airport Improvements.....	13
3.8. Multimodal (Bicycle/Pedestrian) Transportation Corridor/Green Space .....	14
3.9. Infrastructure Costs by Land Use and Phase.....	14
4. INFRASTRUCTURE FINANCING AND SPECIAL DISTRICTS.....	17
4.1. Required Upfront Capital Investment .....	17
4.2. Special Districts.....	19
4.3. Ongoing Operation and Maintenance Costs .....	20
4.4. CLIBP Specific Plan Financing Policies .....	23
4.5. Existing Countywide and Regional Financing Programs .....	23
5. POTENTIAL FINANCING MECHANISMS AND FUNDING SOURCES.....	24
5.1. Enhanced Infrastructure Financing District.....	24
5.2. Other Plan Area Funding Sources.....	26
5.3. County, State, and Federal Sources .....	28
5.4. IBank - California Infrastructure and Economic Development Bank.....	29
5.5. Grant Sources .....	30
6. FINANCING STRATEGY AND ACTIONS.....	31
6.1. Create an Institutional Framework for CLIBP Infrastructure Financing.....	31
6.2. Encourage Private Developer Equity Investment .....	33
7. FEASIBILITY CONSIDERATIONS & RECOMMENDATIONS .....	33

# TABLE OF CONTENTS

<b>FIGURES</b>	<b>PAGE</b>
Figure 1: Planning Area Location.....	2
Figure 2: Airport and Industrial Business Park Areas.....	3
Figure 3: Proposed Plan Phasing.....	4

<b>TABLES</b>	
Table 1: Anticipated Development and Phasing by Land Use Category and Phase (acres).....	7
Table 2: CLIBP Preliminary Infrastructure Costs at Build-out (2015 Dollars) .....	10
Table 3: Off-site and On-site Infrastructure Cost Categories .....	15
Table 4: Infrastructure Cost for Crows Landing Airport Improvements, by Phase (2015 Dollars) .....	16
Table 5: CLIBP Industrial Business Park Area [1] On- and Off-Site Infrastructure Cost by Land Use, by Phase (2015 Dollars) .....	16
Table 6: Industrial Business Park Area [1] On-site and Off-site Per Acre Cost, by Phase (2015 Dollars) .....	17
Table 7: Summary of CLIBP Infrastructure Cost and Per Acre Cost, by Phase (2015 Dollars) .....	18
Table 9: CLIBP Annual Operation & Maintenance Cost [1](2015 Dollars) .....	21
Table 10: CLIBP Annual Operations & Maintenance (O&M) Cost (Cumulative) [1] (2015 Dollars) .....	22
Table 11: City of Patterson Water and Sewer Current Rates (2015) .....	23
Table 12: Crows Landing Industrial Business Park EIFD Analysis, Projected County Property Tax Increment Available for EIFD .....	25
Table 13: Industrial Business Park Area Financing Sources .....	26

## Appendices

- Appendix A CLIBP Infrastructure Improvement Cost Estimates
- Appendix B. Crows Landing Industrial Business Park Enhanced Infrastructure Financing District Feasibility Analysis
- Appendix C. Crows Landing Industrial Business Park, Industrial - Market Update

## ACONYMS AND ABBREVIATIONS

---

### ACRONYMS AND ABBREVIATIONS

AIP	Airport Improvement Program
Air Facility	Crows Landing Air Facility
ATCT	air traffic control tower
CDLAC	California Debt Limit Allocation Committee
CFDs	Community Facilities Districts
CLIBP	Crows Landing Industrial Business Park
CMA	Congestion Mitigation and Air Quality Improvement Program
DMC	Delta Mendota Canal
EIFD	Enhanced Infrastructure Financing District
GA	general aviation
I-5	Interstate Highway 5
IDB	Industrial Development Bond
IP	Infrastructure Policy
ISRF	Infrastructure State Revolving Fund
NPIAS	National Plan of Integrated Airport Systems
Plan Area	Specific Plan Area
PRC	Public Resources Code
Revitalization Districts	Infrastructure and Revitalization Financing Districts
RTP	Regional Transportation Improvements Plan
RTPA	Regional Transportation Planning Agency
SCIP	Statewide Community Infrastructure Program
SCS	Sustainable Communities Strategy
SR	State Route
StanCOG	Stanislaus Council of Governments
STIP	State Transportation Improvement Program
WHWD	Western Hills Water District
WQCF	Water Quality Control Facility



## 1. INTRODUCTION

To support economic development in Stanislaus County, the Crows Landing Industrial Business Park (CLIBP) Specific Plan Area (Plan Area) project promotes redevelopment of the former Crows Landing Air Facility (Air Facility) site for the purpose of creating employment opportunities. The 1,528-acre Plan Area is located in an unincorporated portion of western Stanislaus County, approximately 1.5 miles east of Interstate Highway 5 (I-5) (see Figure 1). Currently, many jobs within the County do not provide wages that are sufficient to sustain a household. The CLIBP project will develop land uses that support local job creation and benefit from the project site's proximity to I-5. The project also includes the creation of a new public use general aviation (GA) airport that would reuse former runway 12-30, the shorter of the two decommissioned runways that is orientated in the northwest-southeast direction (see Figure 2). The airport will serve as an amenity to the CLIBP and the local general aviation community. Approximately 14.3 million square feet of development and approximately 14,450 jobs are projected at CLIBP build-out.<sup>1</sup>

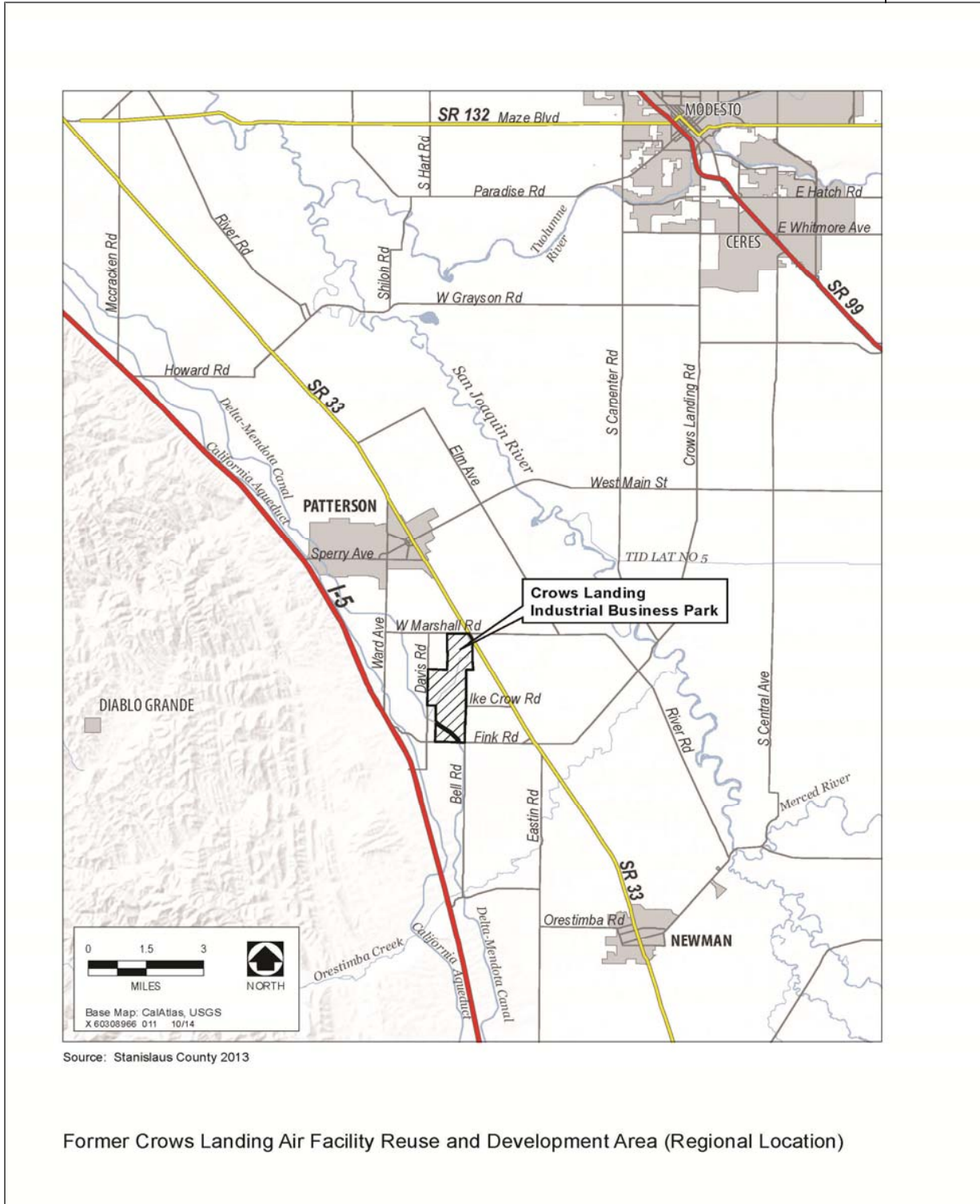
The purpose of the CLIBP project is to create an industrial business park that will bring more liveable-wage jobs to the County, as well as other nearby communities.<sup>2</sup> The CLIBP project will provide opportunities for additional, local sustainable-wage jobs in light industrial, warehouse, logistics, distribution, and business park industries, as well as public facilities and aviation-related businesses, improving the County's jobs-to-housing imbalance and reducing the need for many residents to commute for employment. The County will undertake Phase 1A infrastructure development to render the Plan Area "shovel-ready" for development, and make the site more attractive to potential developers and tenants. This primary or "backbone" infrastructure includes roadway improvements, development of a reliable water supply (potable and non-potable), connections for wastewater collection and treatment, and stormwater management. The cost estimate for the required infrastructure improvements is \$248.6 million (2015 dollars), spread over three, ten-year phases of development. Ongoing operation and maintenance of the new infrastructure and facilities will also be required as part of County municipal services provision in the Plan Area. The estimated annual cost for operations and maintenance is approximately \$1.1 million (2015 dollars) at CLIBP build-out for roadways, street lighting, stormwater pond, multimodal transportation corridor (landscaping), and the airport.

The County's initial investment to make the Plan Area shovel ready as part of Phase 1 will be made for Phase 1A, Fink Road Corridor, development in the southern portion of the Plan Area (see Figure 3). Initial development in the Fink Road Corridor takes advantage of the Plan Area's proximity to I-5 via the Fink Road/I-5 interchange. Development in the Fink Road Corridor is envisioned to support primarily logistics, warehouse, and distribution uses because of its proximity to I-5, but may accommodate other uses. The cost estimate is \$29.6 million for the construction of Phase 1A backbone infrastructure improvements for Fink Road Corridor development. Remaining Phase 1 development includes the Bell Road Corridor, airport, and southern Public Facilities Area (Phase 1B).

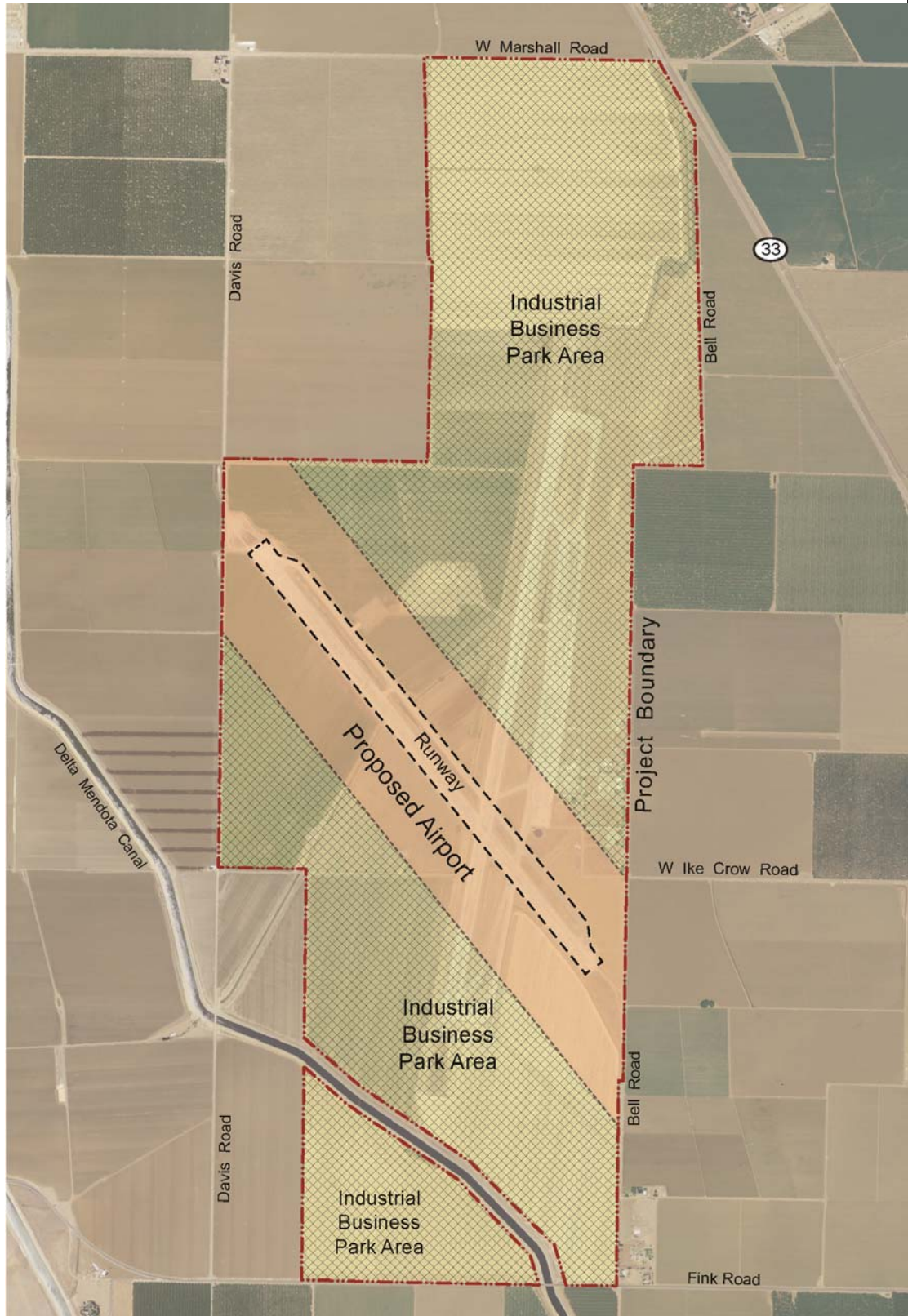
---

<sup>1</sup> Refer to the detailed Land Use and Employment Summary table, provided in Appendix A of the CLIBP Specific Plan, for additional information on estimated land use categories, extent of development associated with each phase, and employment projection at CLIBP build-out.

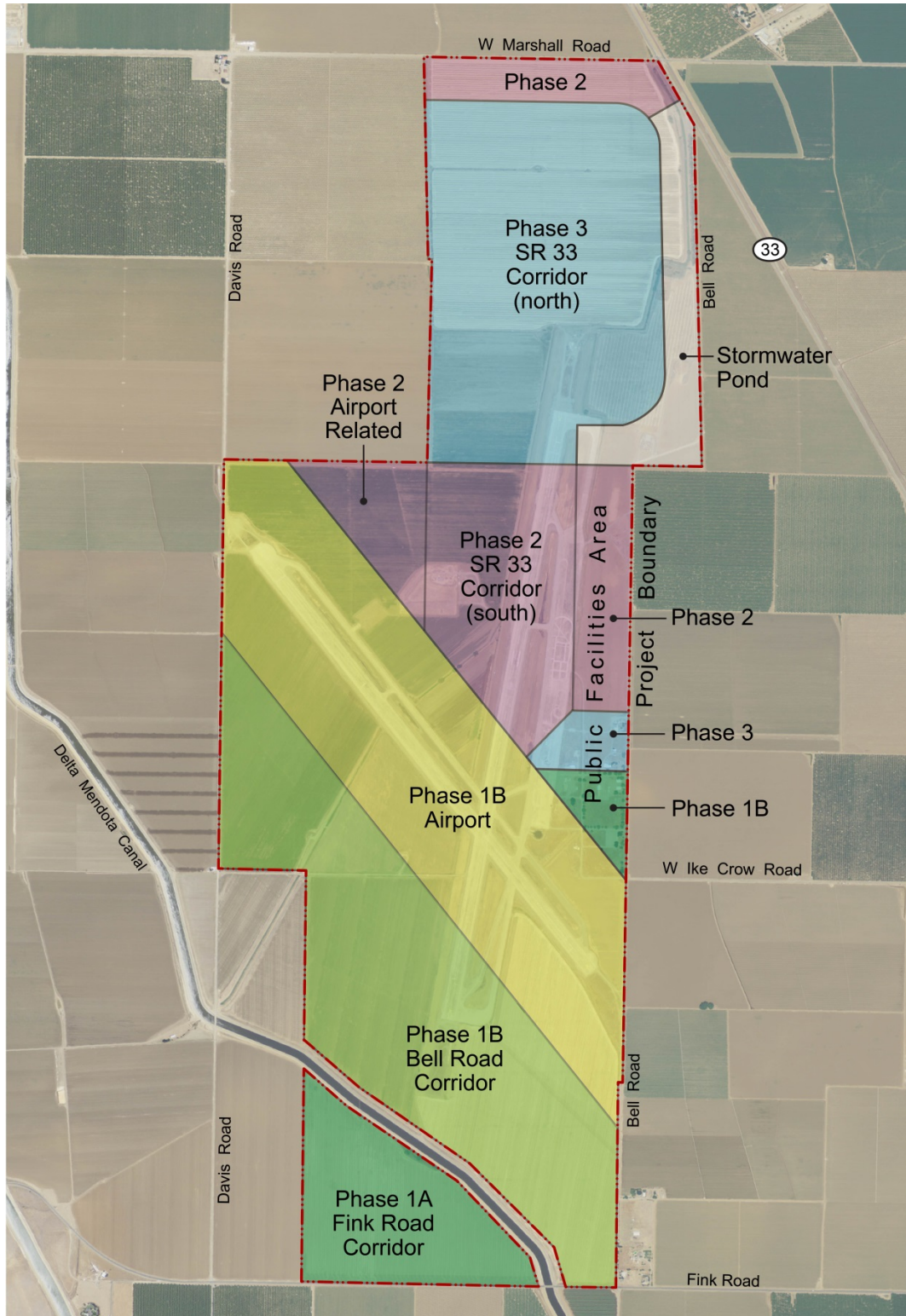
<sup>2</sup> "Liveable wage," or "living wage," is typically defined as the wage level needed to meet basic living expenses such as food, clothing, housing, transportation, health, and personal care).



Source: Stanislaus County 2013  
 Figure 1: Planning Area Location



Source: Stanislaus County 2013  
Figure 2: Airport and Industrial Business Park Areas



Source: AECOM 2016  
Figure 3: Proposed Plan Phasing Areas



The CLIBP Financing Plan provides information on infrastructure and ongoing operation and maintenance costs of the Plan Area, along with potential financing mechanisms and funding sources. Because these available financing options may be insufficient to meet the project financing requirements, especially at the inception of development activity, developer equity will be required to close the funding gap. As in other comparable industrial business parks, one way that the County could achieve its goals for successful Plan Area development and new economic opportunities would be to pursue a public-private partnership, such as design-build-finance of specific infrastructure and/or public facilities, and/or a partnership with a Master Developer who would provide up-front funding and/or construct much of the needed infrastructure improvements for initial CLIBP development. The Master Developer would then be compensated under a reimbursement agreement with the County as specific projects are completed and pay fees for utility services (e.g., water, sewer, and drainage). Upon adoption of the CLIBP Specific Plan and certification of the EIR, including the necessary General Plan Amendment and rezone by the Board of Supervisors, a Request for Proposal (RFP) will be developed to solicit a Master Developer to partner with the County in financing, constructing, and operating the CLIBP. The County intends to retain ownership of the property. The final sections of the Financing Plan describe the recommended financing strategy, actions, and feasibility considerations.

## 2. PROJECT DESCRIPTION

### 2.1. Crows Landing Industrial Business Park (CLIBP) Overview

The 1,528-acre CLIBP Plan Area is bound by W. Marshall Road and State Route (SR) 33 to the north, Fink Road to the south, Bell Road to the east, and Davis Road to the west. Nearly all structures associated with the Plan Area's former military activities were demolished in 2013. The remaining facilities include two decommissioned runways, taxiways, an air traffic control tower (ATCT), and remnant roads. As of 2016, approximately 1,100 acres of the former Air Facility property have been leased for private agricultural use. Agricultural activities will be allowed to continue on-site until such time that the land is needed for imminent infrastructure or leasehold development, in accordance with the CLIBP Specific Plan.

The Specific Plan establishes a land-use policy and regulatory framework for development of the former Air Facility property, consistent with the County's General Plan. Pursuant to the CLIBP Specific Plan, the CLIBP Plan Area includes the following features:

- Approximately 1,274 developable acres will be for industrial business park and airport.
- The remaining 254 acres will be associated with necessary infrastructure, including roads and rights-of-way for stormwater management, water supply, and wastewater facilities.
- A 370-acre general aviation (GA) airport facility will be developed to reuse pavement and infrastructure associated with one of the former military runways, runway 12-30, to the greatest extent practicable.
- Approximately 68 acres located at the northeastern boundary of the GA airport, near the airport entrance, will be used for public facilities, such as law enforcement, emergency services, and local and district government offices.
- Land use categories, including aviation related, business park, light industrial, and logistics/distribution are envisioned to be distributed throughout the Plan Area, with the exception of the airport and the Public Facilities Area.

- A large portion of the Plan Area will likely be developed for logistics, warehouse, and distribution uses, based on the Plan Area's proximity to I-5 and other nearby business parks, where absorption of available industrial/business park space has outpaced new supply over the past five years, particularly for larger building sites.<sup>3</sup>
- Another large portion of the Plan Area will likely be developed for light industrial uses, such as furniture and consumer electronics manufacturing, and machine shops.
- Business park uses envisioned for the Plan Area includes uses such as call centers, research and development, and business support services that may be developed in association with proposed logistics/distribution and light industrial uses or as standalone facilities.
- Approximately 46 acres adjacent to the northwestern airport boundary will be preserved for aviation-related land uses, when feasible, though other industrial business park uses are permitted in this area.

A landscaped multimodal (bicycle/pedestrian) transportation corridor and green space will be developed along or near the CLIBP eastern boundary, north of W. Ike Crow Road, for employee use.

### 2.2. CLIBP Proposed Land Uses

The entire CLIBP Plan Area will be zoned S-P(2). The proposed S-P(2) zone provides the CLIBP flexibility to adjust for new technologies, market conditions, and changes to employment needs. As shown in Figure 3, Plan Area development would occur in three phases as follows:

- Phase 1: 2017 to 2026 (including Phases 1A and 1B)
- Phase 2: 2027 to 2036
- Phase 3: 2037 to 2046

The Specific Plan is intended to support the mix of land uses summarized in Table 1 and described in the sections below, which identify the likely land use categories and extent of development associated with each phase over the 30-year build-out period (also refer to Figure 3), including initial Phase 1 development in the Fink Road Corridor during Phase 1A and in the Bell Road Corridor, airport, and southern Public Facilities Area during Phase 1B. Appendix B of the Specific Plan provides a more detailed list of land uses permitted within each of the land use categories.

---

<sup>3</sup> CLIBP Market Update Memorandum (September 26, 2016) (for informational purposes only)

Table 1: Anticipated Development and Phasing by Land Use Category and Phase (acres)						
Land Use	Description	Phase 1		Phase 2	Phase 3	Total All Phases
		1A	1B			
Logistics/ Distribution	Packaging, warehouse, and distribution, etc.	52	138	57	102	349
Light Industrial	Light industrial manufacturing, machine shops, etc.	41	110	71	128	350
Business Park	Research and development, business support services, etc.	10	28	14	26	78
Public Facilities	Municipal and County offices, professional offices, emergency services, etc.	0	15	35	18	68
General Aviation	Airport runways, aprons, hangars, etc.	0	370	0	0	370
Aviation Related	Parcel distribution, aviation classroom training, etc.	0	0	46	0	46
Multimodal Transportation Corridor/Green Space	Bicycle and pedestrian path, greenway, monument to military use.	0	0	13	0	13
All Uses by Phase		103	661	236	274	1,274
Infrastructure	Internal roadways, water and wastewater systems, stormwater drainage, etc.					254
<b>Plan Area Total</b>						<b>1,528</b>

The CLIBP encompasses 1,274 acres of developable land, and is anticipated to include general aviation (29%), aviation-related uses (4%), logistics/distribution (27%), light industrial (28%), business park (6%), public facilities (5%), and multimodal (bike/pedestrian) corridor/green space (1%). Proposed phasing is described below.

**Phase 1:**

Logistics/Distribution uses will likely develop adjacent to Fink Road (Fink Road Corridor) in Phase 1A, extending into the Bell Road Corridor, which includes the area between the Delta Mendota Canal (DMC) and the airport during Phase 1B, because of the areas’ proximity to the Fink Road/I-5 interchange.

Light industrial uses would likely develop in the southern portion of the Plan Area (Fink Road and Bell Road Corridors) to coincide with or benefit from the initial infrastructure and logistics, warehouse, and distribution uses that would occur in that portion of the Plan Area.

Some business park development is envisioned in the Fink Road and Bell Road Corridors. The logistics, warehouse, distribution, and light industrial development that would include initial roadway improvements and other infrastructure (described in Chapter 4, “Infrastructure,” of the Specific Plan), as a starting point for future phases of business park development.

Public facilities are initially envisioned in the southern portion of the designated Public Facilities Area during Phase 1B, as this area is the former Air Facility’s administration area and contains remnant roadways and

infrastructure that might be refurbished or reactivated to support the industrial business park during initial development.

The general aviation airport, Crows Landing Airport, will be developed in the area associated with the former military runway, runway 12-30, in an effort to reuse pavement and infrastructure to the greatest extent practicable. The airport's location is compatible with the mix of land uses proposed following the application of appropriate guidance and design and development standards set forth in Appendix B of the CLIBP Specific Plan, the County's ALUCP, and applicable FAA regulations and guidance. Existing and proposed roads will serve as barriers between adjacent land uses and the airport, which will be enclosed by a security fence. Potential airport users include business travelers, recreational aviators, flight schools, delivery services, and emergency services. A helipad will be constructed in the southeastern portion of the airport.

### ***Phase 2:***

Logistics/distribution uses are likely to extend northward into the southern portion of the SR 33 Corridor during Phase 2 and benefit from initial airport development, initial logistics, warehouse, and distribution development in the Fink Road and Bell Road Corridors, and initial development in the Public Facilities Area.

Light industrial uses are envisioned in the southern portion of the SR 33 Corridor. Roadway infrastructure associated with westward extension of W. Ike Crow Road, the CLIBP gateway entrances on Bell Road (at W. Ike Crow Road) and on W. Marshall Road during Phase 1 and 2, and W. Marshall Road improvements would support development in this area.

Business park development will likely continue north of the airport in the southern portion of the SR 33 Corridor and along W. Marshall Road, as some synergies will occur in association with the ongoing development and services available in the Public Facilities Area. Improved CLIBP access from SR 33 and W. Marshall Road will facilitate additional business park development in this area.

Aviation-related uses are envisioned within the triangular land use area adjacent to the northern airport boundary, just east of Davis Road. Although light industrial, logistics/distribution, and business park uses are allowed throughout the Plan Area, this area will be preserved during initial development, as feasible, for prospective tenants who require close access to the airport to support their operations, such as airport-related cargo (parcel) distribution and emergency services.

Public facilities development will continue to include the northern portion of the Public Facilities Area.

A north-south multimodal (bicycle/pedestrian) transportation corridor with a one- to two- acre green space will be developed north of W. Ike Crow Road. The bicycle/pedestrian trail will be located east of the Public Facilities Area and west of a new stormwater pond. The corridor will be landscaped and connect to the bicycle/pedestrian path adjacent to Bell Road south of W. Ike Crow Road. The multimodal transportation corridor and stormwater pond provides a physical and visual barrier between the CLIBP and adjacent agricultural land.

### ***Phase 3:***

Some logistics/distribution uses are anticipated to extend into the northern portion of the SR 33 Corridor during Phase 3. Additional improvements to W. Marshall Road and other infrastructure improvements identified for the northern portion of the Plan Area during Phase 3 would support ongoing development.

Light industrial uses will likely expand to the northern portion of the SR 33 Corridor as Phase 3 infrastructure improvements occur and development progresses north toward W. Marshall Road.

Business park development is envisioned in the northern portion of the SR 33 Corridor as infrastructure improvements occur and development progresses north toward W. Marshall Road.

**3. INFRASTRUCTURE AND PUBLIC FACILITY REQUIREMENTS**

This section describes the preliminary planned infrastructure and public facilities required to support development in the CLIBP Plan Area and the associated costs. The cost estimates include infrastructure construction costs, engineering and agency fees, and a contingency. The infrastructure systems and public facilities described in the Specific Plan and summarized in this section are conceptual in nature and may be modified during CLIBP build-out based on changes in technology or the location and intensity of future development.

**3.1. Backbone Infrastructure Definition**

“Backbone Infrastructure” is defined as major public improvements designed to serve the entire Plan Area or substantial portions of the Plan Area, and is the minimum required to support phased Plan Area development based on proposed land uses and development densities/intensities. Backbone infrastructure and public facilities located within the Plan Area, and off-site roadway improvements, which are construction and/or financing requirements for CLIBP development, include the following:

Backbone Infrastructure	Public Facility Areas
Roadways that serve the overall CLIBP Plan Area	General aviation facilities (e.g., runway)
Potable and non-potable water supply and distribution system	Local and district government offices
Off-site intersection mitigation (e.g., traffic signalization) and roadway improvements necessitated by the CLIBP <sup>4</sup>	Public safety and emergency service facilities (e.g., law enforcement, fire suppression)
Wastewater collection system and treatment	<b>Multimodal Transportation/Green Space</b>
Stormwater management	Landsaped multimodal (bicycle/pedestrian) trail

**3.2. Backbone Infrastructure/Public Facilities Costs**

This section briefly summarizes preliminary planned improvement costs. Table 2 summarizes both on-site and off-site infrastructure and public facilities improvement categories (e.g., roadways, water, wastewater, stormwater, airport) and related costs at full build-out of the CLIBP, and from this the County’s estimated initial investment requirement for Phase 1A development. Estimated costs in Table 2 include engineering and agency fees, and a contingency for each improvement category. Cost highlights include a total required investment of approximately \$249.9 million (2015 dollars) over the next 30 years, including approximately \$29.6 million in initial infrastructure investment for development in the Fink Road Corridor, consisting of:

- \$182.9 million for on-site improvements, including:
  - \$50.6 million for backbone roads, including earthwork and grading, street lights, striping and signage, and improvements to the DMC bridge crossing;
  - \$46.5 million for backbone wastewater improvements;
  - \$53.0 million in potable and non-potable water improvements;

<sup>4</sup> Costs for off-site roadway improvements needed due to CLIBP development plus regional growth are included in the Financing Plan, and will be paid by the CLIBP. However, a traffic impact fee will be calculated to determine other future projects’ fair share contribution to reimburse the CLIBP for those required improvements.

## FINANCING PLAN

- \$22.1 million for airport improvements;
- \$8.8 million in backbone stormwater management improvements; and
- \$1.9 million for a multimodal (bicycle/pedestrian) transportation corridor.
- \$67.1 million in off-site improvements, including:
  - \$44.3 million for roadway improvements, including earthwork and grading, street lights, traffic signals, and right-of-way acquisition costs;
  - \$21.4 million for Fink Road/I-5 interchange improvements; and
  - \$1.4 million for a wastewater force main along Ward Avenue

Improvement	Estimated Build-out Cost (Rounded)		Total	Phase 1A
	Off-site	On-site		
<b>Backbone Infrastructure</b>				
Roadways				
Roads	\$26,982,000	\$44,156,000	\$71,138,000	\$3,756,000
Earthwork and Grading	\$374,000	\$1,126,000	\$1,500,000	\$31,000
Traffic Signalization and Lighting	\$11,899,000	\$0	\$11,899,000	\$0
Street Lighting	\$787,000	\$1,978,000	\$2,765,000	\$319,000
Striping and Signage	\$2,066,000	\$1,710,000	\$3,776,000	\$178,000
Fink/I-5 Interchange	\$21,375,000	\$0	\$21,375,000	\$0
DMC Bridge Crossing	\$0	\$1,639,000	\$1,639,000	\$0
Right-of-Way Acquisition	\$2,215,000	\$0	\$2,215,000	\$0
<i>Subtotal</i>	<i>\$65,698,000</i>	<i>\$50,609,000</i>	<i>\$116,307,000</i>	<i>\$4,284,000</i>
Potable Water		\$34,821,000	\$34,821,000	\$10,771,000
Non-Potable Water	\$0	\$18,210,000	\$18,210,000	\$2,213,000
Wastewater	\$1,361,000	\$46,515,000	\$47,876,000	\$12,032,000
Stormwater Management	\$0	\$8,790,000	\$8,790,000	\$321,000
Multimodal Corridor/Green Space	\$0	\$1,853,000	\$1,853,000	\$0
<i>Total</i>	<i>\$67,059,000</i>	<i>\$160,798,000</i>	<i>\$227,857,000</i>	<i>\$29,621,000</i>
Airport	\$0	\$22,058,000	\$22,058,000	\$0
<b>Total Improvements</b>			<b>\$249,915,000</b>	<b>\$29,621,000</b>

*Costs rounded to nearest \$ thousand and may not match totals due to rounding*

The County's initial investment will be for development in Phase 1A, Fink Road Corridor. The initial investment in the Fink Road Corridor will catalyze later development within the CLIBP Plan Area. The sections below describe the improvements associated with the major types of infrastructure and public facilities.

**3.3. Transportation**

The proposed Plan Area backbone roadway network includes connections to the key roadways surrounding the Plan Area. Some off-site roads will also need to be rebuilt/rehabilitated and/or widened and intersections signalized (or reconfigured to include a roundabout) to support CLIBP-related traffic. The Transportation Infrastructure Plan – Crows Landing Industrial Business Park, herein referred to as the Transportation Plan (see Specific Plan, Appendix E), and Chapter 4 of the Specific Plan, “Infrastructure,” identifies roads to be constructed or improved and intersections that will require signalization according to the Specific Plan’s infrastructure and development phasing strategy. The Transportation Plan estimated the associated phase for each needed roadway improvement; however, the timing of improvements will be based on monitoring of roadway conditions during Plan Area build-out. The County provided cost estimates associated with the identified transportation improvements, including roadway improvement requirements and costs for initial backbone infrastructure for Fink Road Corridor development during Phase 1A.

***On-site Roadways***

Plan Area backbone roads will provide primary internal circulation and connections to the surrounding off-site street network. The majority of on-site streets will be designed as three-lane cross sections (two travel lanes and a center-aligned left-turn lane) with parking on each side. An exception to the three-lane cross section design is near the W. Marshall Road (north) entrance, which will have four travel lanes (see Figure 3-7 in Chapter 3, “Built Environment and Design” of the Specific Plan).

Transportation improvements for Plan Area development include construction of backbone roads within the:

- Fink Road Corridor (Phase 1A);
- Bell Road Corridor and southern Public Facilities Area (Phase 1B);
- SR 33 Corridor (south) with a road extending to the W. Marshall Road entrance, the Airport-Related Area, and northern Public Facilities Area (Phase 2); and
- SR 33 Corridor (north) and central Public Facilities Area (Phase 3).

***Off-site Roadways***

Off-site intersection and transportation improvements will be required to support Plan Area development, or a combination of Plan Area development- and regional growth-related traffic. Off-site roadways that will require rebuilding/rehabilitation and/or widening, include:

- W. Ike Crow Road – Bell Road to SR 33 (Phase 1A);
- Bell Road – Fink Road to W. Ike Crow Road (Phase 1A and 1B);
- Davis Road – Fink Road to CLIBP west entrance (Phase 1B);
- W. Marshall Road – CLIBP to SR 33 (Phase 2);
- W. Marshall Road – Ward Avenue to CLIBP (Phase 2 or 3);
- SR 33 - W. Marshall Road to Sperry Avenue (Phase 3);
- SR 33 - Stuhr Road to North of City of Newman (end of Phase 3); and
- I-5 - Fink Road to Sperry Avenue (end of Phase 3).

Additionally, the County will improve Fink Road between I-5 and Bell Road with an added overlay and striping during Phase 1A to ensure a clean functional south entrance to the CLIBP.

The Transportation Plan also identified off-site intersections that will require signalization, or reconfiguration to include a roundabout in lieu of a traffic signal (if applicable), including the CLIBP entrances on W. Marshall Road and Fink Road. Four of these locations are the highest priority and will be needed during late Phase 1 or early Phase 2 development:

- Fink Road at CLIBP entrance (Phase 1B);
- Fink Road at Bell Road (Phase 1B);
- Sperry Avenue at SR 33 (Phase 1B or 2); and
- W. Ike Crow Road at SR 33 (Phase 1B or 2).

An additional eight intersections identified in the Transportation Plan and in Chapter 4, “Infrastructure,” of the Specific Plan will be signalized by the end of Phase 3 (CLIBP build-out).

### ***Fink Road/I-5 Interchange***

In addition to on-site and off-site roadway requirements, improvements are needed for the Fink Road/I-5 interchange. This interchange is less likely to be used than other travel routes by CLIBP employees because I-5 does not provide direct access to the communities in which employees are likely to reside (e.g., Patterson, Newman, Gustine, SR 99 Corridor cities). However, this interchange will be an important link for trucks traveling to and from the CLIBP. The Fink Road/I-5 Interchange improvements, including widening of Fink Road beneath I-5 to create a westbound left turn lane at the southbound ramp and signalizing of northbound ramps, will be required by Phase 1B development.

Excluding the sections of SR 33, I-5, and the eight intersections that require improvements at the end of Phase 3 (identified in the Transportation Plan and Chapter 4, “Infrastructure,” of the Specific Plan), the total CLIBP cost estimate for roadways, including the DMC bridge crossing (\$1.7 million) and the Fink Road/I-5 interchange improvements (\$21.4 million) is \$94.2 million. Related costs include an estimated \$1.5 million for earthwork and grading, \$2.2 million for right-of-way acquisition, \$3.8 million for striping and signage, \$2.8 million for street lighting, and \$11.9 million for traffic signals and lighting. For Phase 1A, Fink Road Corridor, development, the infrastructure development cost estimate for roadway improvements and related costs is \$4.3 million.

### **3.4. Water Supply and Distribution**

As identified in the Crows Landing Industrial Business Park Water Infrastructure and Facilities Study (see Specific Plan, Appendix F) the backbone water supply and distribution system will include construction of infrastructure to provide potable and non-potable water services to the Plan Area. Potable water infrastructure includes new water wells, booster pump stations, wellhead treatment systems, water storage tanks, distribution piping, and valves. Non-potable water infrastructure will include water wells, booster pump station, water well pumps, distribution piping, valves, water storage tank, and fire hydrants. Phasing of the water supply system will coincide with on-site roadway construction. The estimated total CLIBP cost for the on-site water supply and distribution system for potable water is approximately \$34.8 million and approximately \$18.2 million for non-potable water. The cost specifically for water supply to the Phase 1A, Fink Road Corridor, for initial CLIBP development is approximately \$10.8 million for potable water and \$2.2 million for non-potable water.



### 3.5. Wastewater Collection and Treatment

As identified in the Crows Landing Industrial Business Park Sanitary Sewer Infrastructure and Facilities Study (see Specific Plan, Appendix G), the required backbone sanitary sewer infrastructure includes gravity trunk mains, a 2.7-MGD sanitary sewer lift station, a 0.32-MGD sanitary sewer lift station, and a force main within W. Marshall Road to convey effluent to the existing Western Hills Water District (WHWD) trunk main in Ward Avenue. The City of Patterson Water Quality Control Facility (WQCF), which is located about 5 miles north of the Plan Area, conveys, treats, and disposes of wastewater for the WHWD. The gravity trunk mains and the lift stations to be constructed in Phase 1A are sized to accommodate ultimate expansion within the Plan Area, and the force main constructed in Phase 1A is sized to accommodate effluent from Phases 1, 2, and 3. Phasing of the wastewater collection system will coincide with on-site roadway construction and phasing of development to supply adequate services.

The County may allow on-site septic systems to temporarily handle wastewater in the Fink Road Corridor during Phase 1A, until the permanent sewer system and ultimate connection to the City of Patterson WQCF has been completed for Phase 1A development. The specific on-site septic system facilities will be determined and installed prior to issuance of any building permits and will meet Stanislaus County's Guidelines for Septic System Design. Permanent on-site facilities are anticipated to serve development during part or all of Phase 1A. The Financing Plan does not include the cost for an on-site packaged wastewater treatment plant. The estimated total CLIBP cost for the required permanent sanitary wastewater collection system is \$47.9 million, including approximately \$12.0 million for improvements to provide service to Phase 1A, Fink Road Corridor.

### 3.6. Stormwater Management

Based on the Drainage Study for the Crows Landing Industrial Business Park (see Specific Plan, Appendix H), new backbone stormwater management infrastructure will be required for subsequent on-site development. Stormwater infrastructure requirements include, raising a segment of Davis Road, increasing capacity of Little Salado Creek Channel and construction of a stormwater pond, which will include groundwater recharge facilities. Phasing of stormwater management infrastructure will coincide with other infrastructure development, including repaving of the airport runway, to provide adequate drainage. The total estimated CLIBP cost for stormwater management is estimated at \$8.8 million, including approximately \$0.3 million to raise an approximately 750-foot segment of Davis Road for Phase 1A, Fink Road Corridor, development.

### 3.7. Airport Improvements

Approximately 370 acres of the former Air Facility property will be rehabilitated for use as a general aviation airport, Crows Landing Airport. Airport infrastructure improvements required to operate the airport are identified in the Airport Layout Plan (ALP) Narrative Report – Crows Landing Airport (see Specific Plan, Appendix C). The airport infrastructure improvements will be provided by the County over time and as market demand occurs, and will include among other things, the remaking of the northwest-southeast runway (former military runway 12-30) up to 6,300 feet-long by 100-feet-wide, runway lighting and navigational aids, a perimeter fence, and jet fueling facilities. Phase 1 improvements will be constructed to enable the County to obtain an airport operating certificate from the California Department of Transportation's Division of Aeronautics. Additional improvements will be made during Phase 2 and Phase 3 depending on user demand. The ALP includes a full-build-out or "ultimate" airport development scenario; however, the need for these facilities is not anticipated within the CLIBP 30-year build-out period (end of Phase 3) and is not included as part of the CLIBP infrastructure financing cost estimate. The cost for needed airport improvements during

CLIBP buildout is estimated at \$22.1 million through Phase 2 and 3 development. Airport development will begin during Phase 1B.

### **3.8. Multimodal (Bicycle/Pedestrian) Transportation Corridor/Green Space**

An approximately 13-acre multimodal trail north of W. Ike Crow Road is envisioned to be a landscaped bicycle/pedestrian facility with a one- to two- acre green space area for visitor and employee use. The green space will include the former air traffic control tower (ATCT) structure. Although the tower will no longer be used for aviation purposes, the structure would serve as a focal point and monument to commemorate the site's five decades of military use. The estimated cost for the multimodal transportation corridor/green space is \$1.9 million and will be constructed during Phase 2.

### **3.9. Infrastructure Costs by Land Use and Phase**

The Financing Plan aligns the existing infrastructure cost estimates by land use and phase in order to determine the preliminary development cost per acre for the County's initial investment in the CLIBP (Phase 1A), estimated cost for Phase 1B, and projected cost for Phases 2 and 3 infrastructure requirements.

The Financing Plan addresses six development land uses presented in the Specific Plan:

1. General Aviation
2. Aviation-Related
3. Logistics/ Distribution
4. Light Industrial
5. Business Park
6. Public Facilities

The Financing Plan also incorporates on-site and off-site infrastructure costs required to support the Specific Plan's proposed land use development. The cost categories are described in Section 3 and are summarized in Table 3. Refer to Appendix A of this Financing Plan for a detailed list of costs by cost category for each phase of development.

Table 3: Off-site and On-site Infrastructure Cost Categories		
Cost Category	Off-site	On-site
Airport Improvements		✓
Roadways	✓	✓
DMC Bridge Crossing		✓
Fink Road/I-5 Interchange	✓	
Potable Water		✓
Non-Potable Water		✓
Wastewater/Sewer	✓	✓
Stormwater Management		✓
Earthwork and Grading	✓	✓
Street Lighting	✓	✓
Traffic Signals and Lighting	✓	
Striping and Signage	✓	✓
Right-of-Way Acquisition		✓
Multimodal Transportation Corridor/Green Space		✓
Engineering and Agency Fees	✓	✓
20% Sewer and Water Contingency	✓	✓
All Other Contingency	✓	✓

The preliminary apportionment of costs to land use by phase relies on key assumptions. First, the cost for airport improvements are dedicated to the general aviation (GA) land use category. Second, other infrastructure (e.g., roadways) costs are distributed across the other Plan Area land use categories in proportional relationship to the remaining developable area (excluding the 13-acre multimodal transportation corridor) and according to the likely land use categories and extent of development associated with each phase over the 30-year build-out period (Table 1).

As noted in Section 2.1, 1,274 developable acres will be developed for airport and industrial business park uses. For purposes of calculating infrastructure costs associated with development of aviation-related, logistics/distribution, light industrial, business park, and public facilities use, per acre improvements cost associated with the 370-acre airport, Crows Landing Airport, have been calculated separately. Due to the uniqueness of the airport, differences in possible funding sources, and limited potential for generating income compared to other parts of the CLIBP, the airport and associated improvement costs were not included in the total per acre cost for purposes of determining fair share contribution.

Initial airport improvements will be constructed to enable the County to obtain an airport operating certificate from the California Department of Transportation’s Division of Aeronautics during Phase 1. Additional improvements will be constructed during Phase 2 and Phase 3 (based on user demand) as described in Section 3.7 and Chapter 5, “Implementation,” of the Specific Plan. Table 4 summarizes infrastructure costs for the Crows Landing Airport improvements by phase. The cost per acre during Phase 1 is approximately \$18,000 per acre, and \$42,000 per acre for Phase 2 and/or 3. Any additional Phase 3 costs will be TBD and based on user demand. The estimated total per acre cost for the 370-acre airport during CLIBP 30-year build-out is approximately \$60,000.

# FINANCING PLAN

General Aviation	Phase 1 [1]	Phase 2 [2]	Phase 3	Total
Acres	370			
Cost	\$6,569,403	\$15,488,111	TBD	<b>\$22,057,514</b>
Cost Per Acre	\$17,755	\$41,860	TBD	<b>\$59,615</b>
Notes:				
[1] Airport improvements are expected during late Phase 1 (Phase 1B).				
[2] Airport improvements identified for development years 11-30 in the Airport Layout Plan Narrative Report – Crows Landing Airport (2016). All costs are identified in Phase 2 to provide a conservative development cost estimate and will be constructed based on demand.				

Of the 1,274-developable acres, 891 acres will be developed for aviation-related, logistics/distribution, light industrial, business park, and public facilities use. Table 5 provides an estimate of on- and off-site infrastructure costs for these land use categories by phase. Table 6 provides the estimated on-site and off-site infrastructure cost per acre, by phase.

	Aviation-Related	Logistics/Distribution	Light Industrial	Business Park	Public Facilities	Total
<b>Phase 1A</b>						
Acres	0	52	41	10	0	103 <i>(11.6%)</i>
On-site Costs	\$0	\$13,427,930	\$10,587,406	\$2,582,294	\$0	\$26,597,630
Off-site Costs	\$0	\$1,526,460	\$1,203,555	\$293,550	\$0	\$3,023,565
Total	\$0	\$14,954,390	\$11,790,961	\$2,875,844	\$0	\$29,621,195 <i>(13.0%)</i>
<b>Phase 1B</b>						
Acres	0	138	110	28	15	291 <i>(32.7%)</i>
On-site Costs	\$0	\$21,126,289	\$16,839,796	\$4,286,493	\$2,296,336	\$44,548,914
Off-site Costs	\$0	\$16,505,331	\$13,156,423	\$3,348,908	\$1,794,058	\$34,804,720
Total Cost	\$0	\$37,631,620	\$29,996,219	\$7,635,401	\$4,090,393	\$79,353,634 <i>(34.8%)</i>
<b>Phase 1</b>						
Acres	0	190	151	38	15	394 <i>(44.2%)</i>
On-site Costs	\$0	\$34,309,247	\$27,266,823	\$6,861,849	\$2,708,625	\$71,146,544
Off-site Costs	\$0	\$18,242,066	\$14,497,642	\$3,648,413	\$1,440,163	\$37,828,285
Total	\$0	\$52,551,313	\$41,764,465	\$10,510,263	\$4,148,788	\$108,974,829 <i>(47.8%)</i>
<b>Phase 2</b>						
Acres	46	57	71	14	35	223 <i>(25.0%)</i>
On-site Costs	\$8,289,231	\$10,271,438	\$12,794,248	\$2,522,809	\$6,307,024	\$40,184,750
Off-site Costs	\$1,651,082	\$2,045,906	\$2,548,409	\$502,503	\$1,256,258	\$8,004,159
Total	\$9,659,775	\$11,969,721	\$14,909,653	\$2,939,931	\$7,349,829	\$48,188,909 <i>(21.2%)</i>
<b>Phase 3</b>						
Acres	0	102	128	26	18	274 <i>(30.8%)</i>
On-site Costs	\$0	\$18,414,378	\$23,108,239	\$4,693,861	\$3,249,596	\$49,466,074
Off-site Costs	\$0	\$7,901,866	\$9,916,067	\$2,014,201	\$1,394,447	\$21,226,580
Cost	\$0	\$26,316,243	\$33,024,306	\$6,708,062	\$4,644,043	\$70,692,654 <i>(31.0%)</i>
<b>Total</b>						
Acres	46	349	350	78	68	891
Cost	\$9,659,775	\$90,837,278	\$89,698,423	\$20,158,256	\$16,142,660	\$227,856,392

<b>Table 6: Industrial Business Park Area [1] On-site and Off-site Per Acre Cost, by Phase (2015 Dollars)</b>						
	<b>Phase 1A</b>	<b>Phase 1B</b>	<b>Total Phase 1</b>	<b>Phase 2</b>	<b>Phase 3</b>	<b>Build-Out</b>
Acres	103	291	394	223	274	891
On-site Per Acre	\$258,229	\$153,089	\$180,575	\$180,201	\$180,533	\$180,468
Off-Site Per Acre	\$29,355	\$119,604	\$96,011	\$35,893	\$77,469	\$75,263
<b>Total Cost Per Acre</b>	<b>\$287,584</b>	<b>\$272,693</b>	<b>\$276,586</b>	<b>\$216,094</b>	<b>\$258,002</b>	<b>\$255,731</b>

Notes: [1] Excludes 13 acres for multimodal transportation corridor

#### 4. INFRASTRUCTURE FINANCING AND SPECIAL DISTRICTS

Timely construction of public improvements for development of the CLIBP Plan Area will require drawing upon a number of funding sources and financing mechanisms. This section describes key financing mechanisms for funding the improvements. Creating a new industrial business park with major investments required in advance of real estate development and related financing capacity will require substantial public and private investment. As a result, the financing approach for the CLIBP area will require up-front investment of millions of dollars in public funding and financing, private equity, and/or commercial lending. Ongoing operation and maintenance of the new facilities and infrastructure will also be required. A variety of public financing mechanisms and funding sources can partially reimburse for these up-front County investments. Over time as the project matures, substantial financial capacity will evolve that will support the required infrastructure and public services. While this Financing Plan does not specifically determine which resources will be used to finance these improvements, it does recommend a range of potential financing mechanisms and funding opportunities that may be available to the County, including the Enhanced Infrastructure Financing District (EIFD) tax increment financing (TIF) tool.

##### 4.1. Required Upfront Capital Investment

In order to provide an order of magnitude estimate of the total and per acre costs for the capital infrastructure investments required for the CLIBP, AECOM calculated the total required capital investment by phase for the proposed improvements detailed in the CLIBP Specific Plan, including on- and off- site infrastructure. The per acre investment represents the anticipated cost per acre for the CLIBP through each phase, as well as full build-out. The exact nature, structure, and implementation of this investment, whether public or private, will depend on the specific financing mechanism(s) and funding sources selected by the County in partnership with developers (discussed further below in Sections 5 and 6).

Table 7 contains the estimated total infrastructure costs per acre for each phase and provides the average per acre cost for the airport and industrial business park area. The cost for airport improvements is estimated at approximately \$60,000 per acre for development, and the infrastructure cost for both on-site and off-site improvements for the industrial business park area is approximately \$256,000 per acre.

N

**LIBP Infrastructure Cost and Per Acre Cost, by Phase (2015 Dollars)**

Airport Phase 2	Industrial Business Park Area [1]					
	Phase 1A	Phase 1B	Phase 1 Total	Phase 2	Phase 3	Build-Out
<b>370</b>	103	291	<i>394</i>	223	274	<b>891</b>
\$15,488,111	\$29,621,195	\$79,353,634	<i>\$108,974,829</i>	\$48,188,909	\$70,692,654	<b>\$227,856,392</b>
\$41,860	\$287,584	\$272,693	<i>\$276,586</i>	\$216,094	\$258,002	<b>\$255,731</b>
for multimodal transportation corridor in Phase 2						

Table 8 presents the average square foot cost for the industrial business park area, by phase based on the likely extent of development associated with each phase over the 30-year build-out period and floor area ratios consistent with other business parks in the region (see Appendix A, “Crows Landing Land Use and Employment Summary” of the Specific Plan).

<b>Table 8. Industrial Business Park Area [1] Per Building Square Foot (SF) Infrastructure Cost</b>					
	<b>Acres</b>	<b>Total Building Area (SF)</b>	<b>Building Area Per Acre (SF)</b>	<b>Cost Per Acre</b>	<b>Cost Per SF</b>
Phase 1A	103	1,570,000	15,243	\$287,584	\$18.87
Phase 1B	291	4,371,000	15,021	\$272,693	\$18.15
<i>Phase 1</i>	<i>394</i>	<i>5,941,000</i>	<i>15,079</i>	<i>\$276,586</i>	<i>\$18.34</i>
Phase 2	223	3,657,000	16,399	\$216,094	\$13.18
Phase 3	274	4,656,000	16,993	\$258,002	\$15.18
CLIBP Build-Out	891	14,254,000	15,998	\$255,731	\$15.99

[1] Excludes 13 acres for multimodal transportation corridor

#### 4.2. Special Districts

Infrastructure for the CLIBP, including roadways, stormwater management facilities, water supply and distribution, and wastewater collection systems will require a governing agency such as a special district. Special districts are a type of local government that delivers specific public services within defined boundaries. California law enables the creation of numerous types of special districts, and many subcategories of such districts, ranging from airport to cemetery to water conservation districts.<sup>5</sup> Special districts can be formed as independent or dependent districts. Dependent districts, such as a County Service Area (CSA), are governed by existing governments such as a county board of supervisors. Although a CSA is governed by a county, a Local Advisory Group could be formed to advise the board of supervisors on district issues. CSAs can provide any service the County can provide. An independent district is governed by a board that is elected by property owners located within the district’s boundary. Community Service Districts (CSDs) are almost always independent districts.

Special districts can also be single or multi-purpose, delivering more than one service, with CSDs often being multi-purpose districts. CSDs can deliver up to 32 services.<sup>6</sup> Special districts can issue bonds or receive loans from the state or federal government to fund capital projects such as construction of new infrastructure to expand existing services. Typical bonds used include general obligation bonds and benefit assessment bonds. Service districts can also be enterprise or non-enterprise districts. Enterprise districts run much like business enterprises and provide specific benefits to their customers and are primarily funded by the fees that customers pay for services to generate funds for daily operation and maintenance and long-term investments..

For all types of special districts, there are three major types of revenue sources: taxes, service charges or user fees, and benefit assessments. Nearly all special districts can levy a special tax with a 2/3-voter approval, and many can charge a benefit assessment to pay for operating and maintaining public facilities and programs that directly benefit the associated properties. Special districts that run enterprise activities or deliver specific services such as electricity, water, and sewer can pay for their activities with service charges. Unlike special

<sup>5</sup> <http://sgf.senate.ca.gov/sites/sgf.senate.ca.gov/files/SpecialDistrictFactSheet2009.pdf>

<sup>6</sup> Senate Local Government Committee, October 2010, What’s So Special About Special Districts? (Fourth Edition). Available at: [http://www.calafco.org/docs/Special\\_Districts/Whats\\_So\\_Special.pdf](http://www.calafco.org/docs/Special_Districts/Whats_So_Special.pdf)

districts that use service charges to fund additional public services, special assessment districts establish a local tax to generate revenue for enhancing public facilities or programs within the district. Unlike special districts that use financing mechanisms to provide public services, special assessment districts are just financing districts and do not deliver services. See section 5.2 (below) for more information on special assessment districts.

Because of the type, amount, and intensity of development proposed for the CLIBP—compared to other areas of the County—it is anticipated that the O&M costs will be funded using revenue sources outside the County’s traditional revenue stream. By establishing a special district that encompasses the developable land identified within the CLIBP, the County can employ a localized revenue stream designed to fund the anticipated increase in ongoing O&M costs associated with the increase in demand for public utilities such as water and sewer systems. Creating a special district would establish a local governing agency responsible for managing the CLIBP infrastructure.

### **4.3. Ongoing Operation and Maintenance Costs**

Ongoing operation and maintenance of the new facilities and infrastructure will also be required as part of providing County’s municipal services. Table 9 provides estimates per phase and acre for ongoing operation and maintenance (O&M) costs for both on-site and off-site roads, streetlights, stormwater management facilities, the multimodal transportation corridor and green space (landscaping), and airport. Table 10 provides the cumulative total. The estimated annual cost for operations and maintenance for these infrastructure improvements is approximately \$848 per developable acre at CLIBP build-out. Special districts can generate additional revenue that can be used to fund localized O&M costs.

Service charges, or “user fees,” typically generate funds for daily operation and maintenance and long-term investments for drinking water and wastewater systems. Pricing of water service should accurately reflect true costs of providing high-quality water and wastewater service to users to maintain infrastructure and plan for upcoming repairs, rehabilitation, and replacement of services.



Table 9: CLIBP Annual Operation & Maintenance Cost [1](2015 Dollars)										
Infrastructure Type	Phase 1A		Phase 1B		Phase 1 Total		Phase 2		Phase 3	
	On-site	Off-Site	On-Site	Off-Site	On-Site	Off-Site	On-Site	Off-Site	On-Site	Off-Site
Roadways [1][2]	\$7,680	\$31,374	\$60,360	\$31,670	\$68,040	\$63,044	\$64,704	\$7,883	\$116,551	\$54,196
Streetlights	\$2,640	\$10,800	\$20,160	\$9,600	\$22,800	\$20,400	\$21,600	\$5,040	\$38,880	\$7,680
Stormwater Pond	\$2,640	\$0	\$10,000	\$0	\$10,000	\$0	\$5,000	\$0	\$5,000	\$0
Multimodal Corridor	\$0	\$0	\$0	\$0	\$0	\$0	\$30,096	\$0	\$0	\$0
Airport	\$0	\$0	\$138,313	\$0	\$138,313	\$0	\$326,066	\$0	\$0	\$0
Total	\$10,320	\$42,174	\$228,833	\$41,270	\$239,153	\$83,444	\$447,466	\$12,923	\$160,431	\$61,876
Total + 10% Admin. Fee	<b>\$11,352</b>	<b>\$46,391</b>	<b>\$251,716</b>	<b>\$45,397</b>	<b>\$263,068</b>	<b>\$91,789</b>	<b>\$492,212</b>	<b>\$14,216</b>	<b>\$176,474</b>	<b>\$68,063</b>
Total Per Phase	\$57,743		\$297,114		\$354,857		\$506,428		\$244,537	
Acres	103		661		764		236		274	
Cost Per Developable Acre	\$110	\$450	\$381	\$69	\$344	\$120	\$2,086	\$60	\$644	\$248
Cost Per Developable Acre (Total)	\$561		\$449		\$464		\$2,146		\$892	
Notes: [1] Excludes water and wastewater O&M costs [2] Includes sidewalks and swales [3] Off-site roadways include Bell, Davis, W. Ike Crow, and W. Marshall Roads; SR 33 (Sperry Ave. to W. Marshall Road)										

<b>Table 10: CLIBP Annual Operations &amp; Maintenance (O&amp;M) Cost (Cumulative) [1] (2015 Dollars)</b>			
	<b>On-Site Infrastructure</b>	<b>Off-Site Infrastructure [2]</b>	<b>Total</b>
Phase 1A	\$11,352	\$46,391	\$57,743
Phase 1B	\$263,068	\$91,789	\$354,857
<i>Phase 1</i>	<i>\$263,068</i>	<i>\$91,789</i>	<i>\$354,857</i>
Phase 2	\$755,280	\$106,004	\$861,285
Phase 3	\$931,755	\$174,068	\$1,105,822
Cost Per Developable Acre	\$731	\$137	\$868
Notes:			
[1] Excluding water and wastewater O&M costs			
[2] Off-site roadways include Bell, Davis, W. Ike Crow, and W. Marshall Roads; SR 33 (Sperry Ave. to W. Marshall Road)			

**Water and Wastewater Service Charges**

A special district would be capable of assessing and collecting the appropriate service charges for both water and sewer utilities. Service charges are assessed based on the type of user as well as proportional usage. Revenue generated by service charges are structured in a way to appropriately cover the O&M costs associated with the delivering the service. Such costs typically include, administrative functions, labor (salary & benefits), utility operation and maintenance, and capital improvement (repair & renovations). Other operational revenues may be generated by various user fees such as connection/reconnection fees, late payment fees, and other miscellaneous fees. It is anticipated that 100% of the operational O&M costs for the water system and the sewer system would be recovered through the associated service charges and user fees.

Service charges for water and wastewater connections are more commonly referred to as water and/or sewer rates (rates). Rates are administered by the associated governing agency and are typically assessed on a tiered basis given the type of user and the volume of inflow and/or outflow. In order to establish rates compliant with Proposition 218 (1996)<sup>7</sup> the County would need to conduct a rate study to ensure the service charges applied within the CLIBP do not exceed the cost required to provide the service, and that all charges represent a proportional share of cost recovery. In other terms, rates cannot exceed the O&M costs and rates must be distributed according to the proportional usage of each user. Typically new taxes or other property-related charges require voter approval however, Article 13D of Proposition 218 removes the voter-approval requirement for rates associated with water, sewer, and garbage services.

As an example, the City of Patterson, California is located approximately six miles to the northwest of the CLIBP site and may serve as a helpful case study for assessing water and sewer rates. Though the City has a significant residential population, the industrial corridors have a similar land use/building type as is proposed in the CLIBP. The City’s water rates are based off a rate study completed in 2010 and the sewer rates are based on a rate study completed in 2015. Table 11 details the water and sewer rates. Note these rates are presented for illustrative purposes only and the County should conduct a rate study specific for CLIBP to assess new rates.

<sup>7</sup> California Article 13D, Section 6, 1996 (Proposition 218) sets forth the requirements and circumstances that must be met for a government or governing agency to assess a fee or tax on real property including service charges.

Table 11: City of Patterson Water and Sewer Current Rates (2015)				
Water Quantity Rates			Sewer Rates	
Tier	Volume	Cost/ccf Effective 01/01/15	Industrial Flow	Effective 12/2/15
Tier 1	0 to 3 ccf	\$1.24	Flow – per gallon	\$0.00495979
Tier 2	3.1 to 20 ccf	\$1.60	BOD – per lb	\$0.62308428
Tier 3	20.1 to 50 ccf	\$1.96	SS – per lb	\$0.62308428
Tier 4	Over 50 ccf	\$2.76		

Source: City of Patterson Ordinance No. 713 and Resolution No. 2015-67

**4.4. CLIBP Specific Plan Financing Policies**

Chapter 4 of the CLIBP Specific Plan, “Infrastructure,” includes policies related to the infrastructure improvements and to the provision of services. Major utilities and infrastructure is needed to support the development envisioned for the CLIBP Plan Area. The County will construct the essential backbone infrastructure improvements and establish methods for distributing costs associated with serving the Plan Area. While the County wants to ensure there is adequate financing for the construction of backbone infrastructure and ongoing municipal services, the County does not want to place an undue financial burden on future CLIBP users. Off-site transportation improvement costs paid for by the CLIBP, for CLIBP-induced and regional growth-induced traffic, will be allocated to future area projects that will also benefit from the improvements for their fair share contribution to reimburse the CLIBP. Two Specific Plan policies address the distribution of these costs.

- **Infrastructure Policy (IP) 3:** Establish equitable methods for distributing costs associated with Plan Area development. The costs of new regional infrastructure shall be allocated to the users that benefit from the improvements.
- **Transportation Policy (TP) 13:** Equitable methods shall be established for distributing costs associated with constructing off-site transportation improvements required as a result of regional growth- and CLIBP-related land uses.

**4.5. Existing Countywide and Regional Financing Programs**

Development of the CLIBP may participate in the following infrastructure improvement financing policies and programs.

- **Stanislaus Council of Governments (StanCOG).** At the state-designated Regional Transportation Planning Agency (RTPA) for Stanislaus County, StanCOG serves as the conduit for non-local funding of regional transportation improvements listed in the Regional Transportation Improvements Plan (RTP). Funding is provided through various regional, state, and federal sources.
- **Stanislaus County AB1600 Fees.** The Countywide Development Impact Fees fund general government, sheriff, emergency services, street improvements, and other County facilities. The County currently receives impact fees dedicated to Regional Transportation Impact Fee and Public Facilities Fee improvements.

**5. POTENTIAL FINANCING MECHANISMS AND FUNDING SOURCES**

Stanislaus County established a development entitlement vehicle for the CLIBP project through the County’s specific plan process and accompanying design guidelines and infrastructure plans. Concurrent with the specific plan process, the County is exploring public financing options that it may pursue to help fund backbone infrastructure for the Plan Area. Over the course of CLIBP development, it is likely that a range of public financing mechanisms will be used to pay for infrastructure and public facilities. These mechanisms will augment and, in some cases, reimburse the capital financing that is likely to be necessary in early stages of development. The financing for infrastructure improvements and public facilities, as well as for ongoing operations required by the CLIBP, have multiple sources in addition to the existing Countywide and Regional programs discussed in Section 4.5. The County took initial steps in identifying an infrastructure financing mechanism that informs the CLIBP Financing Plan by evaluating the feasibility of forming an Enhanced Infrastructure Financing District.

**5.1. Enhanced Infrastructure Financing District**

Senate Bill (SB) 628 of 2014 (Beall) authorizes the creation of Enhanced Infrastructure Financing Districts (EIFDs), which give local government agencies (primarily cities, counties, and special districts) another avenue to finance the construction or rehabilitation of public infrastructure, as well as some private projects. The EIFD is a governmental agency established by a city, county, or special district that carries out a plan within a defined area (e.g., specific plan area) to construct, improve, and rehabilitate public infrastructure; construct housing, libraries and parks; remediate brownfields; and for military base reuse projects. Non-contiguous areas are permitted within the EIFD.

Similar to former state enabling legislation (now discontinued) that allowed cities and counties to establish redevelopment agencies and project areas, EIFDs are financed through property tax increment generated from the growth in property value that largely accrues from property improvements and that is collected from a legally defined financing district. Local government agencies must voluntarily agree to contribute tax increment funds to the EIFD, and those funds cannot be collected from K-12 districts, community college districts, and county offices of education. EIFDs can also be formed without the finding that the area is blighted or urbanized. Private facilities financed by an EIFD may include, but are not limited to:

- Acquisition, construction, and repair of industrial structures for private use;
- Transit priority projects defined under Public Resources Code (PRC) Section 21155; and
- Projects that implement the regional Sustainable Communities Strategy (SCS).

No voter approval is required to form an EIFD, but a 55 percent affirmative vote is required for the EIFD’s issuance of bonds. According to an EIFD feasibility analysis conducted for the County, conditions are favorable towards an EIFD formation for the CLIBP project:

- As the landowner, the County may legally form an EIFD because it owns all the legal parcels that would be included in the EIFD formation.
- The Air Facility property is County-owned with a beginning assessed value of zero, meaning new assessed value increases would create tax increment revenues that can be pledged to an EIFD.
- Land and future project development owned in fee-simple title by an end-user would create a land value that would generate enough tax increment to support an EIFD formation.
- Under a ground-lease scenario, leases of 35 years or greater would likely result in the County’s

# FINANCING PLAN

Assessors' office determining the value of long-term leases "as if" the project were owned in fee-simple title, collecting property taxes on the possessory interest in the property.

- If formed, an EIFD is not likely to include any additional taxing entities besides the County.

Table 12 summarizes the finding of the analysis, showing the annual estimated EIFD tax increment and cumulative EIFD tax increment for a 45 year-period of time from EIFD formation. Refer to Appendix B for additional information about the feasibility analysis, including the absorption and valuation assumptions used in the analysis and next steps.

<b>Table 12: Crows Landing Industrial Business Park EIFD Analysis, Projected County Property Tax Increment Available for EIFD</b>									
Year	<b>Annual EIFD Tax Increment (Rounded)</b>				<b>Cumulative EIFD Tax Increment (Rounded)</b>				
	<b>Free Simple Scenario</b>		<b>Possessory Interest Scenario</b>		<b>Free Simple Scenario</b>		<b>Possessory Interest Scenario</b>		
	Slow Growth	Fast Growth	Slow Growth	Fast Growth	Slow Growth	Fast Growth	Slow Growth	Fast Growth	
2017	\$0	\$0	\$0	\$0	\$0	\$0	\$0	\$0	
2018	\$65,000	\$86,000	\$55,000	\$73,000	\$65,000	\$86,000	\$55,000	\$73,000	
2019	\$131,000	\$175,000	\$112,000	\$149,000	\$196,000	\$261,000	\$167,000	\$222,000	
2020	\$202,000	\$270,000	\$172,000	\$229,000	\$398,000	\$531,000	\$339,000	\$451,000	
2021	\$276,000	\$369,000	\$235,000	\$314,000	\$674,000	\$900,000	\$574,000	\$765,000	
2022	\$355,000	\$475,000	\$302,000	\$403,000	\$1,029,000	\$1,375,000	\$876,000	\$1,168,000	
2023	\$439,000	\$586,000	\$373,000	\$498,000	\$1,468,000	\$1,961,000	\$1,249,000	\$1,666,000	
2024	\$527,000	\$704,000	\$448,000	\$598,000	\$1,995,000	\$2,665,000	\$1,697,000	\$2,264,000	
2025	\$620,000	\$829,000	\$527,000	\$704,000	\$2,615,000	\$3,494,000	\$2,224,000	\$2,968,000	
2026	\$718,000	\$960,000	\$610,000	\$815,000	\$3,333,000	\$4,454,000	\$2,834,000	\$3,783,000	
2027	\$822,000	\$1,098,000	\$698,000	\$933,000	\$4,155,000	\$5,552,000	\$3,532,000	\$4,716,000	
2028	\$931,000	\$1,244,000	\$790,000	\$1,056,000	\$5,086,000	\$6,796,000	\$4,322,000	\$5,772,000	
2029	\$1,046,000	\$1,397,000	\$888,000	\$1,187,000	\$6,132,000	\$8,193,000	\$5,210,000	\$6,959,000	
2030	\$1,167,000	\$1,559,000	\$991,000	\$1,324,000	\$7,299,000	\$9,752,000	\$6,201,000	\$8,283,000	
2031	\$1,294,000	\$1,729,000	\$1,099,000	\$1,468,000	\$8,593,000	\$11,481,000	\$7,300,000	\$9,751,000	
2032	\$1,428,000	\$1,908,000	\$1,212,000	\$1,620,000	\$10,021,000	\$13,389,000	\$8,512,000	\$11,371,000	
2033	\$1,569,000	\$2,095,000	\$1,331,000	\$1,780,000	\$11,590,000	\$15,484,000	\$9,843,000	\$13,151,000	
2034	\$1,716,000	\$2,293,000	\$1,457,000	\$1,948,000	\$13,306,000	\$17,777,000	\$11,300,000	\$15,099,000	
2035	\$1,872,000	\$2,500,000	\$1,589,000	\$2,124,000	\$15,178,000	\$20,277,000	\$12,889,000	\$17,223,000	
2036	\$2,035,000	\$2,718,000	\$1,727,000	\$2,309,000	\$17,213,000	\$22,995,000	\$14,616,000	\$19,532,000	
2037	\$2,206,000	\$2,946,000	\$1,872,000	\$2,504,000	\$19,419,000	\$25,941,000	\$16,488,000	\$22,036,000	
2038	\$2,386,000	\$3,186,000	\$2,025,000	\$2,708,000	\$21,805,000	\$29,127,000	\$18,513,000	\$24,744,000	
2039	\$2,575,000	\$3,438,000	\$2,185,000	\$2,922,000	\$24,380,000	\$32,565,000	\$20,698,000	\$27,666,000	
2040	\$2,773,000	\$3,702,000	\$2,352,000	\$3,146,000	\$27,153,000	\$36,267,000	\$23,050,000	\$30,812,000	
2041	\$2,980,000	\$3,978,000	\$2,528,000	\$3,382,000	\$30,133,000	\$40,245,000	\$25,578,000	\$34,194,000	
2042	\$3,197,000	\$4,268,000	\$2,712,000	\$3,628,000	\$33,330,000	\$44,513,000	\$28,290,000	\$37,822,000	
2043	\$3,425,000	\$4,572,000	\$2,905,000	\$3,886,000	\$36,755,000	\$49,085,000	\$31,195,000	\$41,708,000	
2044	\$3,664,000	\$4,890,000	\$3,107,000	\$4,157,000	\$40,419,000	\$53,975,000	\$34,302,000	\$45,865,000	
2045	\$3,914,000	\$5,223,000	\$3,318,000	\$4,440,000	\$44,333,000	\$59,198,000	\$37,620,000	\$50,305,000	
2046	\$4,176,000	\$5,571,000	\$3,540,000	\$4,736,000	\$48,509,000	\$64,769,000	\$41,160,000	\$55,041,000	
2047	\$4,449,000	\$5,936,000	\$3,772,000	\$5,047,000	\$52,958,000	\$70,705,000	\$44,932,000	\$60,088,000	
2048	\$4,736,000	\$6,318,000	\$4,014,000	\$5,371,000	\$57,694,000	\$77,023,000	\$48,946,000	\$65,459,000	
2049	\$5,036,000	\$6,717,000	\$4,268,000	\$5,711,000	\$62,730,000	\$83,740,000	\$53,214,000	\$71,170,000	
2050	\$5,349,000	\$7,135,000	\$4,533,000	\$6,066,000	\$68,079,000	\$90,875,000	\$57,747,000	\$77,236,000	
2051	\$5,677,000	\$7,571,000	\$4,810,000	\$6,437,000	\$73,756,000	\$98,446,000	\$62,557,000	\$83,673,000	
2052	\$6,019,000	\$8,028,000	\$5,100,000	\$6,825,000	\$79,775,000	\$106,474,000	\$67,657,000	\$90,498,000	
2053	\$6,377,000	\$8,504,000	\$5,403,000	\$7,230,000	\$86,152,000	\$114,978,000	\$73,060,000	\$97,728,000	
2054	\$6,752,000	\$9,003,000	\$5,720,000	\$7,654,000	\$92,904,000	\$123,981,000	\$78,780,000	\$105,382,000	
2055	\$7,142,000	\$9,523,000	\$6,050,000	\$8,096,000	\$100,046,000	\$133,504,000	\$84,830,000	\$113,478,000	
2056	\$7,551,000	\$10,066,000	\$6,396,000	\$8,558,000	\$107,597,000	\$143,570,000	\$91,226,000	\$122,036,000	
2057	\$7,977,000	\$10,634,000	\$6,756,000	\$9,041,000	\$115,574,000	\$154,204,000	\$97,982,000	\$131,077,000	
2058	\$8,422,000	\$11,226,000	\$7,133,000	\$9,544,000	\$123,996,000	\$165,430,000	\$105,115,000	\$140,621,000	
2059	\$8,887,000	\$11,844,000	\$7,526,000	\$10,070,000	\$132,883,000	\$177,274,000	\$112,641,000	\$150,691,000	
2060	\$9,372,000	\$12,489,000	\$7,936,000	\$10,619,000	\$142,255,000	\$189,763,000	\$120,577,000	\$161,310,000	
2061	\$9,653,000	\$12,864,000	\$8,174,000	\$10,938,000	\$151,908,000	\$202,627,000	\$128,751,000	\$172,248,000	

Source: Economic & Planning Systems, Inc. (EPS) 2016, Table 2

## FINANCING PLAN

It is important to note that the EIFD Feasibility Analysis only estimates the tax increment that would be generated by the EIFD through 2061, and does not provide a specific analysis of the potential bonding capacity of the EIFD. Since in the early years of the District the tax increment generated is relatively low, it is likely that the County would need to bond against future estimated tax increment revenues, or execute a developer agreement with CLIBP property owners to reimburse some or all of the upfront infrastructure investments that they might contribute as part of the initial capital financing.

Using the fast growth, fee simple scenario from Table 12, Table 13 compares the potential EIFD tax increment to infrastructure cost for each phase of development and the funding to be covered by developer equity and/or other public source(s).

### 5.2. Other Plan Area Funding Sources

Site area funding sources are generated within the development area and typically require property-owner support. Although the County's General Fund often pays for some or all of the seed money to generate funds from these sources, they do not necessarily require commitments from the General Fund or from other local revenue sources. The following funding sources should be considered in combination with the EIFD and upfront developer equity contributions to offset both capital and operations and maintenance costs.

Phases	Acres	Infrastructure Cost [1]	Infrastructure Cost Per Acre	Financing Sources			
				EIFD		Developer Equity & Other Public Sources	
				Total	Per Acre	Total	Per Acre
Phase 1	394	\$108,974,829	\$276,586	\$4,454,000	\$11,305	\$104,520,829	\$265,281
1A	103	\$29,621,195	\$287,584	\$900,000	\$8,738	\$28,721,195	\$278,847
1B [2]	276	\$79,353,634	\$272,693	\$3,554,000	\$12,213	\$75,799,634	\$260,480
Phase 2 [3]	223	\$48,188,909	\$216,094	\$18,541,000	\$83,143	\$29,647,909	\$132,950
Phase 3	274	\$70,692,654	\$258,002	\$41,774,000	\$152,460	\$28,918,654	\$105,543
Total	891	\$227,856,392	\$255,731	\$64,769,000	\$72,692	\$163,087,392	\$183,039

Notes:  
 [1] Excluding airport improvements  
 [2] Excluding acres for airport  
 [3] Excluding acres for multimodal transportation corridor

### ***Special Assessment District***

A Special Assessment District is a financing mechanism under The California Streets and Highways Code, Divisions 10 and 12, that enables cities, counties, and special districts organized for the purpose of aiding in the development or improvement to, or within, the district. Special assessment districts (also known as benefit assessment districts or maintenance assessment districts) can pay for both capital facilities and operation and maintenance of public facilities within the district. The formation of a special assessment district requires a majority vote from property owners within its boundaries, with individual votes weighted on the proportionate share of each property's assessed value relative to the total annual assessment. Special assessment districts are appropriate when the funded facilities directly benefit the development, including streets, sidewalks, curbs and gutters, lighting, drainage or flood control facilities. Anything that provides general public benefit (e.g. parks, libraries, childcare) cannot be financed using a Special Assessment District.

Once approved, a Special Tax Lien is placed against each property in the District. Property owners then pay a special tax each year.

### ***Lighting and Landscape District***

Adopted in 1972, the Lighting and Landscape District Act (Streets and Highways Section 22500) allows local government agencies (including cities and counties) to form a landscape and lighting district to finance landscaping and lighting in public areas and to finance parks, open space, and community centers. As a form of a benefit assessment, properties within the District pay for improvements financed through increased property values. Improvements include, but are not limited to, the installation and maintenance of:

- Landscaping
- Statues and fountains
- General lighting
- Traffic lights
- Recreational and playground courts and equipment
- Public restrooms

Additionally, this tool allows acquisition of land for parks and open spaces. Notes or bonds can be used to finance larger improvements under the Act. In order to approve the district, a majority vote of affected property owners through an assessment balloting procedure is required. Once approved, assessments will be placed on property tax bills each year to pay for the improvements and services. Assessments that pay for ongoing services will continue as long as services are provided.

### ***Mello-Roos Community Facilities District***

The Mello-Roos Community Act allows a county, city, special district, school district, or joint powers authority to establish Mello-Roos Community Facilities Districts (CFDs) to help finance public improvements and certain services. A CFD may fund those public services permitted by the Community Services Act (1982), including sheriff services; trails, parks, and open space; and fire protection/suppression/ambulance/paramedic services. Created by the local government agency, the CFD includes all properties that will benefit from the improvements and services. A CFD is similar to a special assessment district; however, a CFD requires a two-thirds majority vote of residents within the CFD boundary, or if fewer than 12 residents, the current landowners. In many cases, that may be a single owner or developer. Once approved, a Special Tax Lien is placed against each property in the CFD. Property owners then pay a special tax each year.

Many practitioners feel that the Mello-Roos proceedings provide more flexibility in allocating costs than special assessment districts because Mello-Roos levies are not required to be apportioned based on direct benefit. Thus, levies may be used to fund improvements of general benefits, such as fire and police facilities, as well as improvements that benefit specific properties. The provisions under Mello-Roos also allow for levies to be set and infrastructure costs to be allocated in a manner that alleviates the cost burden for specific classes of development.

### ***Infrastructure and Revitalization Financing Districts***

AB 229 of 20214 (Perez) authorizes the creation of Infrastructure and Revitalization Financing Districts (Revitalization Districts) by the legislative body of a city or county to finance projects of “communitywide significance” pursuant to an infrastructure financing plan adopted by the district. A Revitalization District

may be formed for up to 40 years by passage of a resolution of intent. The resolution of intent must specify the boundaries of the Revitalization District, the types of projects the Revitalization District will finance, and state that incremental property tax revenues may be used to finance the Revitalization District's projects, provided that use of incremental tax revenues allocated to any other taxing agency must be approved by said agency.

The issuance of bonds by a Revitalization District requires 2/3 voter approval. The legislative body of a city or county may also dedicate a portion of its funds from the Redevelopment Property Tax Trust Fund to the Revitalization District.

**5.3. County, State, and Federal Sources**

***Sales Tax***

Jurisdictions may elect to submit a sales tax override measure to the electorate for approval. Sales tax override measures require a two-thirds voter approval and generate a sales tax increment above the current maximum collected by the agency. The local agency can issue bonds to fund infrastructure that would be secured by the future sales tax revenues.

***Gas Tax***

Gas tax is directed specifically to transportation funding which can be used for transportation maintenance, improvements, and management. This includes funding streetscape improvements. The majority of funds go towards maintenance and operation of the County's existing transportation infrastructure. Gas tax capital improvement funds are earmarked through the County's Capital Improvement Plan.

***General Obligation***

Proposition 46 allows counties to issue general obligation bonds. General obligation bonds, which are repaid with revenues from increased property taxes, may be used to finance land acquisition and construction of capital improvements. A general obligation bond requires a two-thirds voter approval

***Revenue Bonds***

Counties can use bonds to finance facilities for revenue-producing enterprises, such as water and sewer improvements. The bonds are repaid solely from the revenues generated by the financed facility. Revenue bond issuance may require voter authorization.

***State Proposition 1B***

Proposition 1B, Highway Safety, Traffic Reduction, Air Quality, and Port Security Bond Act of 2006 authorizes the state to sell approximately \$20 billion of general obligation bonds to fund transportation projects to relieve congestion, improve the movement of goods, improve air quality, and enhance the safety and security of the transportation system. The bond money is available for expenditure by various state agencies and for grants to local agencies and transit operators upon appropriation by the legislature. There is approximately \$1.6 billion left in current programs available for disbursement.

***State Transportation Improvement Program (STIP)***

The State Transportation Improvement Program is the statewide plan to fund transportation improvements. The STIP identifies a number of Federal and state transportation programs that will be used on transportation capital improvement projects. These include Federal distributions such as the Congestion



Mitigation and Air Quality Improvement Program (CMAQ), Transportation Enhancement Activities, and the Regional Surface Transportation Program. Seventy-five percent of the funding goes to the local regions through a competitive process for local projects. Twenty-five percent of the statewide funding goes to Caltrans for projects of inter-regional significance. STIP funds are available in even numbered years.

### ***Statewide Community Infrastructure Program***

The Statewide Community Infrastructure Program (SCIP) is a development impact fee-financing program that uses proceeds from the sale of bonds enabled under so-called “1913/15” Act. There are two SCIP programs, the “Reimbursement Program” and the “Pre Funding Program,” that are funded by tax-exempt bonds. SCIP can be used for:

- Commercial, industrial, retail, and multi- and single-family residential projects; and
- Roads, water, sewers, storm drainage, and parks.

SCIPs are also a good economic tool for larger commercial and industrial projects where developers pay substantial fees to obtain permits. The Pre Funding program provides up front financing for improving inadequate infrastructure that may be impeding development and hampering timely project approvals. There is not cost for a local agency to join SCIP.

### **5.4. IBank - California Infrastructure and Economic Development Bank**

#### ***Infrastructure State Revolving Fund Loan Program***

The Infrastructure State Revolving Fund (ISRF) Loan Program provides low-cost financing to public agencies and public benefit tax-exempt non-profit corporations for a wide variety of infrastructure and economic development projects. Funding amounts range from \$50,000 to \$25,000,000, with loan terms up to 30 years. The interest rate is set at the time the financing is approved. Eligible project categories including:

- Streets and county highways
- Public transit
- Sewage collection and treatment
- Water treatment and distribution
- Drainage, water supply and flood control
- Solid waste collection and disposal
- Educational facilities (e.g., libraries, child care and employment training facilities)
- Parks and recreational and pool facilities
- Public safety facilities (e.g., police and fire stations, jails)
- Power and communications facilities
- Environmental mitigation measures
- Defense conversion
- Economic expansion (e.g. industrial, utility, and commercial facilities and social welfare facilities)

For more information about the program, including project category details, please see: [http://www.ibank.ca.gov/infrastructure\\_loans.htm](http://www.ibank.ca.gov/infrastructure_loans.htm).

### ***Industrial Development Revenue Bond Program***

Industrial Development Bonds (IDBs) are tax-exempt securities issued up to \$10 million by a governmental entity to provide money of the acquisition, construction, rehabilitation, and equipping of manufacturing and processing facilities for private companies. IDBs can be issued by the California Infrastructure and Development Bank (IBANK) through Infrastructure State Revolving Fund Loan Program, local Industrial Development Authorities, or by Joint Powers Authorities. Benefits of IDB financing include lower interest rates, long-term financing, often up to 30 years (cannot exceed 120% of the average of the average economic life of the assets financed). The project financed by the bonds must meet certain public benefit criteria established by the California Debt Limit Allocation Committee (CDLAC), which include, among other things, the creation or retention of jobs.

### **5.5. Grant Sources**

Several sources of grant funding may be available at the regional, state, or federal level. However, the availability of funding is limited.

### ***U.S. Economic Development Administration Public Works Program***

Under this FFO, EDA solicits applications from applicants in rural and urban areas to provide investments that support construction, non-construction, technical assistance, and revolving loan fund projects under EDA's Public Works and EAA programs. Grants and cooperative agreements made under these programs are designed to leverage existing regional assets and support the implementation of economic development strategies that advance new ideas and creative approaches to advance economic prosperity in distressed communities. EDA provides strategic investments on a competitive-merit-basis to support economic development, foster job creation, and attract private investment in economically distressed areas of the United States.

### ***Clean Water State Revolving Fund Program, Expanded Use***

#### **Proposition 1 Funding (Grants and Loans)**

Proposition 1 funds numerous grant and loan programs that provide water infrastructure funding. Two of these programs could potentially provide partial funding assistance for CLIPB's (??) proposed drainage and stormwater management infrastructure improvements:

- The Storm Water Grant Program (SWGP), provides funding for multi-benefit storm water management projects to improve regional water self-reliance, security, and adapt to the effects on water supply arising from climate change.
- The Groundwater Sustainability Program (GSP), funds groundwater clean-up and treatment for potable water based on a project's potential to remediate groundwater contamination, enhance local water supply reliability, and recharge vulnerable, high-use groundwater basins. The GSP may have limited applicability to CLIBP, however.

Links to these programs appear below:

- [http://www.waterboards.ca.gov/water\\_issues/programs/grants\\_loans/proposition1.shtml](http://www.waterboards.ca.gov/water_issues/programs/grants_loans/proposition1.shtml).

- [http://www.waterboards.ca.gov/publications\\_forms/publications/factsheets/docs/groundwater\\_quality\\_funding.pdf](http://www.waterboards.ca.gov/publications_forms/publications/factsheets/docs/groundwater_quality_funding.pdf).

***State and Federal Funding Sources for Airport Improvements***

**Airport Improvement Program**

The Airport Improvement Program (AIP) provides grants to public agencies — and, in some cases, to private owners and entities — for the planning and development of public-use airports that are included in the National Plan of Integrated Airport Systems (NPIAS).

In general, sponsors can use AIP funds on most airfield capital improvements or repairs. AIP grants cannot be used on exclusive-use areas in terminals, revenue producing areas of terminals, hangars and non-aviation development. Any professional services that are necessary for eligible projects, such as planning, surveying and design, are also eligible; however, operating expenses of AIP projects are not eligible. Aviation demand at the airport must justify the projects, which must also meet federal environmental and procurement requirements.

**California Department of Transportation, Division of Aeronautics**

The Division of Aeronautics offers a 5% match program for federal grant recipients under the AIP for airports included in the state airports Capital Improvements Program.

**6. FINANCING STRATEGY AND ACTIONS**

Due to the disparity between the upfront capital funding requirements and the initial financing capacity of the Enhanced Infrastructure Financing District and other potential funding mechanisms, substantial initial developer equity contributions will be required for the CLIBP. In total, it is estimated that approximately \$29.6 million in upfront developer investment would be needed for initial CLIBP infrastructure development for Phase 1A absent any other sources of subsidy or funding other than the EIFD. These developer contributions would come from private equity or commercial lending and could be combined flexibly with other sources to provide a blend of capital financing to support infrastructure costs. As in other similar development in California, a developer agreement would need to be structured to allow for these upfront contributions to be reimbursed over time as the CLIBP achieves full build-out and begins to generate substantial annual revenues through EIFD tax increment or other sources. Assuming that the creation of an EIFD would be feasible per the EPS Study described above, AECOM recommends the following key actions to implement a financing strategy:

**6.1. Create an Institutional Framework for CLIBP Infrastructure Financing**

- 1. Continue refining CLIBP infrastructure and public facility improvement program, including:**
  - analyzing all infrastructure improvements identified for the CLIBP to assure completeness and accuracy and to assist assignment of funding responsibility and linkages to financing mechanism;
  - continue to evaluate specific infrastructure items in relation to likely development patterns and establish a detailed schedule for completing the improvements, including operations and maintenance schedules to reduce life-cycle costs; and,
  - begin engineering design.

## **2. Establish an Enhanced Infrastructure Financing District (EIFD):**

As noted in Section 5.1, passage of recent legislation allows the creation of an EIFD to provide financing for qualifying CLIBP infrastructure improvement work. If the County Board of Supervisors (Board) chooses to pursue formation of an EIFD, the County will establish the EIFD as outlined under “Next Steps” of the EIFD Feasibility Analysis (Appendix B). At the same time, the County needs to determine how to fund the investment using the variety of funding streams available to EIFDs, such as state and federal funds, assessment revenues, fee revenues, and public debt. The County will also need to establish a link between the payer and beneficiary.

## **3. Establish special district(s) for infrastructure improvements and operation and maintenance costs:**

Special districts can be single or multi-function. The Stanislaus Local Agency Formation Commission (LAFCo) provides for the orderly formation of local agencies, preserves agricultural resources, and discourages urban sprawl. To accomplish these goals, LAFCo reviews proposals for formation of new agencies, as well as proposed changes to existing agencies, and has the power to either approve or deny the proposal based on its review. The formation of a new district or annexation of an area into an existing district requires LAFCo approval.

Either a County Service Area (CSA) or a Community Services District (CSD) could provide all of the public utility services. A CSD, which are mostly independent districts, that provides all services may be difficult due to the cost of the equipment required for completing maintenance work. The County may be better able to provide services with equipment it already owns and operates, which would make a CSA (as a dependent agency of the County) a better option for maintaining roads, street lighting, stormwater management facilities, and landscaping. A CSA can establish tax rates, service charges, and benefit assessments, as well as connection charges, for the Plan Area and must be based on the direct, proportionate special benefit derived from the service or maintenance cost. The County would run the CSA. It is further recommended that the County consider additional special districts for the CLIBP, including a special district to manage the water and wastewater systems necessary to support the development and a special district for the airport.

## **4. Consider and pursue other complimentary funding mechanisms and sources for the industrial business park, including the airport, such as:**

- Mello-Roos CFD: The special tax does not have to be based on benefit and instead can be spread across developable land. However, the tax should be apportioned on a reasonable basis by other measures such as square footage of new construction or density of development. Because the tax can be based on measures other than benefit, it is recommended that the County analyze the potential for establishing a CFD for permissible services.
- Other funding sources: The initial years of development will likely have annual shortfalls in funding for public services, even with the collection of special taxes and assessments because certain levels of service will be required prior to generating revenue from new development. Revenues from sources such as gas tax, grants, and other local, state, and federal financing and funding programs should be considered and pursued. The County should also provide minimum acceptable service levels to reduce costs.

### 6.2. Encourage Private Developer Equity Investment

1. Provide flexibility:

Incorporate a provision that provides flexibility and options in the infrastructure Financing Plan that respond to economic conditions as they evolve.

2. Ensure oversizing of infrastructure:

Obligate developers to fund (oversize) infrastructure, improvements not otherwise funded with available public sources during the early phases of development when capacity of public financing sources will be limited.

3. Provide for credits and reimbursements:

Advanced private funding of infrastructure and public facilities should be secured through the adopted financing mechanisms.

### 7. FEASIBILITY CONSIDERATIONS & RECOMMENDATIONS

Demonstrating reasonable industry standards of risk and reward is essential for attracting private and public support and for successfully implementing the Specific Plan. The preliminary infrastructure costs provided in the previous section contribute towards calculating the financial feasibility of the Specific Plan. However, the overall financial feasibility, and the alignment of appropriate funding sources, depends on a more detailed development program showing revenue and benefit relative to current market conditions. As part of future work, an aggregate cost burden analysis will indicate the total cost of infrastructure and public facilities relative to the total development value created. Similarly, a nexus study will help determine maximum and recommended development fees under AB1600 and similar policy requirements.



## APPENDIX A CLIBP Infrastructure Improvement Cost Estimates

Appendix A. CLIBP Infrastructure Improvement Cost Estimates, Phase 1A					
Description	Quantity	Unit	Unit Price	Phase 1A Onsite	Phase 1A Offsite
<b>EARTHWORK AND GRADING</b>					
Earthwork and Grading (Backbone Roadway 2 - Fink Rd to DMC)	4.41	acre	\$5,000	\$22,039	\$0
<b>ROADWAYS</b>					
Bell Road (Fink Rd to W. Ike Crow Rd) - Initial .25' Overlay - Plate 3-A11 (60' ROW) - Offsite	5,280	l.f.	\$80	\$0	\$422,400
Backbone Roadway 1 between Fink Rd and DMC	1,600	l.f.	\$512	\$819,200	\$0
W. Ike Crow Rd Overlay (Bell Rd to SR 33) Plate 3-A11 to 3-A12 - Offsite	6,340	l.f.	\$80	\$0	\$507,200
Fink Road (I-5 to Bell Rd) - 25' Overlay (32' wide) - Offsite	11,090	l.f.	\$80	\$0	\$887,200
<b>STORMWATER MANAGEMENT</b>					
Davis Rd Raise	1	l.s.	\$225,250	\$225,250	\$0
<b>WASTWATER</b>					
18" Pipe	10,506	l.f.	\$130		
12" Pipe	2,992	l.f.	\$100		
8" Pipe	2,146	l.f.	\$80		
12" Force Main	12,400	l.f.	\$120		
Type A Case I Manhole	56	each	\$9,000		
2.80 MGD Lift Station	1	l.s.	\$1,750,000		
0.32 MGD Lift Station	1	l.s.	\$200,000		
Tunneled Crossing (Delta Mendota Canal South of Airport)	300	l.f.	\$250		
<b>Subtotal</b>				\$5,855,000	\$0
Sewer Connection Cost				\$3,600,000	\$0
<b>POTABLE WATER</b>					
12" PVC	4,240	l.f.	\$65		
12" Gate Valve	4	each	\$1,000		
Potable Water Well and Booster Pump Station	1	each	\$2,500,000		
Potable Water Storage Tanks (1.4 MG)	1	each	\$2,550,000		
Wellhead Treatment System	1	l.s.	\$2,150,000		
<b>Subtotal</b>				\$7,479,600	\$0
<b>NON-POTABLE WATER</b>					
12" PVC	3,500	l.f.	\$65		
12" Gate Valve	4	each	\$1,000		
Fire Hydrant, Bury, and Gate Valve	11	each	\$5,000		
Non-Potable Water Storage Tanks (0.75 MG)	1	each	\$1,250,000		
<b>Subtotal</b>				\$1,536,500	\$0
<b>STREET LIGHTING</b>					
200 Watt Electrolier - Fink Rd (I-5 to Bell Rd)	45	each	\$4,000	\$0	\$180,000
201 Watt Electrolier - Backbone Roadway 2 (Fink Rd to DMC)	11	each	\$4,000	\$44,000	\$0
<b>STRIPING AND SIGNAGE</b>					
Signage (Fink Rd Entrance)	1	l.s.	\$125,000		\$125,000
			Subtotal	\$19,581,589	\$2,121,800
			Contingency (25%, excludes sewer and water)	\$316,489	\$604,713
			Contingency (20% for sewer and water)	\$3,569,864	\$0
			<b>Construction Subtotal</b>	<b>\$23,467,942</b>	<b>\$2,726,513</b>
<b>ENGINEERING AND AGENCY FEES</b>					
Civil Engineering and Construction Staking	8%	est.		\$88,839	\$169,744
Agency Plan Checking	1%	est.		\$11,105	\$21,218
Agency Inspection - Construction Management	5%	est.		\$55,524	\$106,090
Engineering Costs (20% for sewer and water)				\$2,974,220	\$0
			<b>Fee Subtotal</b>	<b>\$3,129,688</b>	<b>\$297,052</b>
<b>Total Phase 1A (On-Site &amp; Off-Site) Costs</b>				<b>\$26,597,630</b>	<b>\$3,023,565</b>
<b>TOTAL PHASE 1A COSTS</b>					<b>\$29,621,195</b>

APPENDIX A

Appendix A. CLIBP Infrastructure Improvement Cost Estimates, Phase 1B					
Description	Quantity	Unit	Unit Price	Phase 1B Onsite	Phase 1B Offsite
<b>EARTHWORK AND GRADING</b>					
Earthwork and Grading (Backbone Roadways)	39.05	acre	\$5,000	\$195,248	
Bridge Ramp (DMC)	1	each	\$50,000	\$50,000	
Earthwork and Grading (Bell & Davis Rds)	26.92	acre	\$5,000		\$134,578
<b>AIRPORT IMPROVEMENTS</b>					
Remove old runway lighting and level runway RSA, OFZ and OFA				\$712,000	
Perform Airport Pavement Management Plan and clean and fill runway/taxiway/apron pavement cracks / other pavement repairs				\$589,600	
Prepare Airfield Marking Plan, remove old airfield marking and paint new taxiway and runway markings for visual runway				\$214,000	
Repair airport access roads and utilities				\$425,000	
Construct airport entrance and parking spaces				\$468,080	
Install airport entrance sign				\$60,000	
Install apron security lighting near airport entrance				\$210,000	
Install 25,000 LF 8 foot fence with 3-strand barbed wire along airport boundary and manual gate at airport entrance				\$890,000	
Install 4 taxiway hold signs				\$30,000	
Install segmented circle and 3 wind cones (non-lit)				\$72,500	
Install 10 tie-downs and site preparation for 5 hangars				\$122,500	
Install 780 s.f. modular unit for operations office with restrooms and utility connections				\$256,750	
Install 12,000 gallon skid-mounted general aviation fuel tank (100LL), jet-A refueler truck, truck pad and wash rack				\$160,000	
Construct Connector Taxiways A2, A3, A4, A5.				\$400,000	
<b>ROADWAYS</b>					
Bell Rd (82' ROW to include 2 travel lanes & center-aligned left turn lane, 24' swale, 12' shoulder/landscape, and 10' bike/ped path)	5,280	l.f.	\$430		\$2,270,400
Backbone Roadways 1,2,4 (3 lanes, 120 ft ROW includes two 24' swales, 6' sidewalks, 3 travel lanes and parking)	12,575	l.f.	\$512	\$6,438,400	
Davis Rd (Fink Rd to CLIBP W. Entrance) Plate 3-A11 for non-fronting and 72' ROW with 24' swale for project fronting. - Offsite	7,805	l.f.	\$307		\$2,397,696
<b>STORMWATER MANAGEMENT</b>					
Triple 4x8 Box Culverts	2,085	l.f.	\$800	\$1,668,000	
Headwalls	2	each	\$25,000	\$50,000	
On-Site Channel Earthwork	40,000	c.y.	\$10	\$400,000	
Detention Basin/Stormwater Pond Earthwork	368,807	c.y.	\$5	\$1,844,035	
Detention Basin/Stormwater Pond Inlet/Outlet Works	1	each	\$50,000	\$50,000	
Infiltration Trenches	16,791	c.y.	\$25	\$419,775	
<b>WASTEWATER</b>					
15" Pipe	518	l.f.	\$110		
12" Pipe	3028	l.f.	\$100		
10" Pipe	5,367	l.f.	\$90		
8" Pipe	17,228	l.f.	\$80		
Type "A" Case I Manhole	28	each	\$9,000		
<b>Subtotal</b>				\$2,475,000	\$0
Sewer Connection Cost				\$9,900,000	\$0
<b>POTABLE WATER</b>					
12" PVC	34460	l.f.	\$65		
12" Gate Valve	34	each	\$1,000		
<b>Subtotal</b>				\$2,273,900	\$0
<b>NON-POTABLE WATER</b>					
18" PVC	5,300	l.f.	\$100		
12" PVC	29,500	l.f.	\$65		
18" Gate Valve	5	each	\$5,000		
12" Gate Valve	29	each	\$1,000		
New Nonpotable Well & Booster Pump Station	1	each	\$2,500,000		
Non-Potable Water Well Pump	2	each	\$500,000		
Fire Hydrant, Bury, and Gate Valve	89	each	\$5,000		
<b>Subtotal</b>				\$6,446,500	\$0



APPENDIX A

Appendix A. CLIBP Infrastructure Improvement Cost Estimates, Phase 1B					
Description	Quantity	Unit	Unit Price	Phase 1B Onsite	Phase 1B Offsite
<b>STREET LIGHTING</b>					
200 Watt Electrolier - Backbone Roadways 1, 2, 4	84	each	\$4,000	\$336,000	
200 Watt Electrolier - Bell and Davis Rds	40	each	\$4,000		\$160,000
<b>TRAFFIC SIGNALS AND LIGHTING</b>					
Traffic Signal - Sperry Ave at SR 33	1	each	\$1,300,000		\$1,300,000
Traffic Signal - W. Ike Crow Rd at SR 33	1	each	\$1,300,000		\$1,300,000
Traffic Signal - Fink Rd at Bell Rd	1	each	\$450,000		\$450,000
Traffic Signal - Fink Rd at Project Entrance	1	each	\$450,000		\$450,000
<b>STRIPING AND SIGNAGE</b>					
Striping	1	l.s.	\$200,000	\$200,000	
Signage	1	l.s.	\$200,000	\$200,000	
Striping (Davis Rd)	1	l.s.	\$125,000		\$125,000
<b>MISCELLANEOUS</b>					
Delta Mendota Bridge Crossing	1	each	\$1,150,000	\$1,150,000	
I-5 / Fink Road Interchange Improvements	1	l.s.	\$15,000,000		\$15,000,000
			Subtotal	\$38,707,288	\$24,424,365
			Contingency (25%, excludes sewer and water)	\$5,019,388	\$6,960,944
			Contingency (20% for sewer and water)	\$2,686,896	\$0
			<b>Construction Subtotal</b>	<b>\$46,413,572</b>	<b>\$31,385,309</b>
<b>ENGINEERING AND AGENCY FEES</b>					
Civil Engineering and Construction Staking	8%	est.		\$1,408,951	\$1,953,949
Agency Plan Checking	1%	est.		\$176,119	\$244,244
Agency Inspection - Construction Management	5%	est.		\$880,594	\$1,221,218
Engineering Costs (20% for sewer and water, noted above)				\$2,239,080	\$0
			<b>Fee Subtotal</b>	<b>\$4,704,744</b>	<b>\$3,419,411</b>
<b>Total Phase 1B (On-Site &amp; Off-Site) Costs</b>				<b>\$51,118,316</b>	<b>\$34,804,720</b>
<b>TOTAL PHASE 1B COSTS</b>					<b>\$85,923,036</b>

APPENDIX A

Appendix A. CLIBP Infrastructure Improvement Cost Estimates, Phase 2					
Description	Quantity	Unit	Unit Price	Phase 2 Onsite	Phase 2 Offsite
<b>EARTHWORK AND GRADING</b>					
Earthwork and Grading (Backbone Roadways Only)	39.18	acre	\$5,000	\$195,900	
Earthwork and Grading (W. Marshall Rd - CLIBP to SR 33)	6.54	acre	\$5,000		\$32,714
<b>AIRPORT IMPROVEMENTS</b>					
Construct additional apron area to accommodate aircraft tiedowns, hangars and FBO sites				\$4,110,000	
Construct internal perimeter access road and install manual gate at Bell Road to access helipad				\$505,000	
Paint helipad markings on southwest side of runway				\$25,000	
Remark Runway 11-29 to reflect non-precision (GPS based) instrument approach				\$60,000	
Install Medium Intensity Runway Edge Lights (MIRL)				\$398,300	
Install Runway End Identifier Lights (REILS) at each runway end				\$42,550	
Install Precision Approach Path Indicator (PAPI) at each runway end				\$334,500	
Install rotating beacon				\$40,000	
Light existing wind cones (3 wind cones)				\$43,500	
Construct additional apron area northeast of airfield				\$4,860,000	
Replace modular unit with permanent terminal building including pilot lounge, restrooms and airport office space(s)				\$450,000	
<b>ROADWAYS</b>					
Backbone Roadways (3 lanes, 120 ft)	13,480	l.f.	\$630	\$8,492,400	
Marshall Rd (CLIBP frontage) 4 lanes (94' ROW)	3,032	l.f.	\$494		\$1,496,292
<b>STORM DRAINAGE</b>					
Detention Basin/Stormwater Pond Earthwork	113,925	c.y.	\$5	\$569,625	
Infiltration Trenches	5,187	c.y.	\$25	\$129,675	
<b>WASTEWATER</b>					
12" Pipe	1318	l.f.	\$100		
10" Pipe	971	l.f.	\$90		
8" Pipe	7,661	l.f.	\$80		
12" Force Main	7,870	l.f.	\$120		\$945,000
Type "A" Case I Manhole	20	each	\$9,000		
<b>Subtotal</b>				\$1,013,000	\$945,000
Sewer Connection Cost				\$6,500,000	\$0
<b>POTABLE WATER</b>					
12" PVC (Potable Water)	32,700	l.f.	\$65		
12" Gate Valve (Potable Water)	32	each	\$1,000		
Potable Water Well and Booster Pump Station	1	each	\$2,500,000		
Potable Water Storage Tanks (1.4 MG)	1	each	\$1,650,000		
Wellhead Treatment System	1	l.s.	\$2,150,000		
<b>Subtotal</b>				\$8,457,500	\$0
<b>NON-POTABLE WATER</b>					
12" PVC	33,000	l.f.	\$65		
12" Gate Valve	33	each	\$1,000		
Fire Hydrant, Bury, and Gate Valve	83	each	\$5,000		
<b>Subtotal</b>				\$2,593,000	\$0
<b>STREET LIGHTING</b>					
200 Watt Electrolier	90	each	\$4,000	\$360,000	
200 Watt Electrolier (W. Marshall Rd - CLIBP to SR 33)	21	each	\$4,000		\$84,000
<b>TRAFFIC SIGNALS AND LIGHTING</b>					
Traffic Signal - Marshall Rd at SR 33	1	each	\$1,300,000		\$1,300,000
Traffic Signal - Fink Rd at SR 33	1	each	\$1,300,000		\$1,300,000
<b>STRIPING AND SIGNAGE</b>					
Striping	1	l.s.	\$200,000	\$200,000	
Signage	1	l.s.	\$200,000	\$200,000	
Striping	1	l.s.	\$300,000		\$300,000
Signage	1	l.s.	\$100,000		\$100,000
<b>GREENWAY TRANSPORTATION CORRIDOR</b>					
Multimodal Transportation Corridor/Green Space	2	mile	\$650,000	\$1,300,000	

APPENDIX A

Appendix A. CLIBP Infrastructure Improvement Cost Estimates, Phase 2					
Description	Quantity	Unit	Unit Price	Phase 2 Onsite	Phase 2 Offsite
<b>RIGHT-OF-WAY ACQUISITION</b>					
Marshall Rd (CLIBP to SR 33)	1.40	acre	\$35,000		\$49,000
			Subtotal	\$40,879,950	\$5,607,006
			Contingency (25%, excludes sewer and water)	\$6,360,188	\$1,328,672
			Contingency (20% for sewer and water)	\$2,895,320	\$226,800
			<b>Construction Subtotal</b>	<b>\$50,135,458</b>	<b>\$7,162,478</b>
<b>ENGINEERING AND AGENCY FEES</b>					
Civil Engineering and Construction Staking	8%	est.		\$1,785,316	\$372,961
Agency Plan Checking	1%	est.		\$223,165	\$46,620
Agency Inspection - Construction Management	5%	est.		\$1,115,823	\$233,100
Engineering Costs (20% for sewer and water)				\$2,413,100	\$189,000
			<b>Fee Subtotal</b>	<b>\$5,537,403</b>	<b>\$841,681</b>
<b>Total Phase 2 (On-Site &amp; Off-Site) Costs</b>				<b>\$55,672,861</b>	<b>\$8,004,159</b>
<b>TOTAL PHASE 2 COSTS</b>					<b>\$63,677,020</b>

APPENDIX A

Appendix A. CLIBP Infrastructure Improvement Cost Estimates, Phase 3					
Description	Quantity	Unit	Unit Price	Phase 3 Onsite	Phase 3 Offsite
<b>EARTHWORK AND GRADING</b>					
Earthwork and Grading (Backbone Roadways Only)	65.41	acre	\$5,000	\$327,050	
Earthwork and Grading (W. Marshall Rd – CLIBP to Ward Ave.)	19.1	acre	\$5,000		\$95,500
<b>AIRPORT IMPROVEMENTS</b>					
Acquire 202 acres for future airport expansion and remove obstructions					
Construct 1,000-foot extension of Runway 11 to north & blast pad, realign REILS, & remark runway for precision instrument approach					
Construct and mark new parallel taxiway and remark old taxiway pavement as closed					
Construct internal perimeter access road around Runway 11 extension, abandon segment of Davis Road and remove segment of perimeter fence					
Install 10,500 ft. of perimeter security fencing to enclose future airport property and additional security gate					
Install MALS approach lighting at both ends of Runway 11-29					
Mark blast pad for Runway 29					
Construct additional apron area west of runway					
<b>ROADWAYS</b>					
North Entrance Backbone Roadways (4 lanes, 120 ft)	2,895	l.f.	\$630	\$1,823,850	
Backbone Roadways (3 lanes, 120 ft)	21,290	l.f.	\$630	\$13,412,700	
Marshall Rd (Ward Ave to CLIBP) Plate 3-A12	8,568	l.f.	\$97		\$831,096
SR 33 (Marshall Rd to Sperry Ave) Plate 3-A15	12,270	l.f.	\$825		\$10,122,750
<b>STORM WATER MANAGEMENT</b>					
Detention Basin/Stormwater Pond Earthwork	132,268	c.y.	\$5	\$661,340	
Infiltration Trenches	6,022	c.y.	\$25	\$150,550	
<b>WASTEWATER</b>					
10" Pipe	3,037	l.f.	\$90		
8" Pipe	13,326	l.f.	\$80		
Type "A" Case I Manhole	33	each	\$9,000		
<b>Subtotal</b>				\$1,638,000	
Sewer Connection Cost				\$10,700,000	
<b>POTABLE WATER</b>					
12" PVC	20,000	l.f.	\$65		
12" Gate Valve	20	each	\$1,000		
Water Well and Booster Pump Station	1	each	\$2,500,000		
Wellhead Treatment System	1	LS	\$2,150,000		
<b>Subtotal</b>				\$5,970,000	
<b>NON-POTABLE WATER</b>					
12" PVC	20,000	l.f.	\$65		
12" Gate Valve	20	each	\$1,000		
Fire Hydrant, Bury, and Gate Valve (Non-Potable Water)	50	each	\$5,000		
Water Well Pump	1	each	\$500,000		
<b>Subtotal</b>				\$2,070,000	
<b>STREET LIGHTING</b>					
200 Watt Electrolier	162	each	\$4,000	\$648,000	
200 Watt Electrolier (W. Marshall Rd – CLIBP to Ward Ave.)	32	each	\$4,000		\$128,000
<b>TRAFFIC SIGNALS AND LIGHTING</b>					
Traffic Signal - Marshall Rd at Ward Ave	1	each	\$450,000		\$450,000
Traffic Signal - Marshall Rd at Project Entrance	1	each	\$450,000		\$450,000
Traffic Signal - Carpenter Rd at W. Main St	1	each	\$450,000		\$450,000
Traffic Signal - Crows Landing Rd at W. Main St	1	each	\$450,000		\$450,000
Traffic Signal - Crows Landing Rd at Marshall Rd	1	each	\$450,000		\$450,000
<b>STRIPING AND SIGNAGE</b>					
Striping	1	l.s.	\$200,000	\$200,000	
Signage	1	l.s.	\$200,000	\$200,000	

APPENDIX A

Appendix A. CLIBP Infrastructure Improvement Cost Estimates, Phase 3					
Description	Quantity	Unit	Unit Price	Phase 3 Onsite	Phase 3 Offsite
Striping	1	l.s.	\$400,000		\$400,000
Signage - Offsite	1	l.s.	\$400,000		\$400,000
<b>RIGHT-OF-WAY ACQUISITION</b>					
Marshall Rd (Ward Ave to CLIBP Entrance)	2.2	acre	\$35,000		\$77,000
SR 33 (Marshall Rd to Sperry Ave)	16.9	acre	\$35,000		\$591,500
			Subtotal	\$37,801,490	\$14,895,846
			Contingency (25%, excludes sewer and water)	\$4,965,695	\$4,245,316
			Contingency (20% for sewer and water)	\$2,323,600	\$0
			<b>Construction Subtotal</b>	<b>\$45,090,785</b>	<b>\$19,141,162</b>
<b>ENGINEERING AND AGENCY FEES</b>					
Civil Engineering and Construction Staking	8%	est.		\$1,393,879	\$1,191,668
Agency Plan Checking	1%	est.		\$174,235	\$148,958
Agency Inspection - Construction Management	5%	est.		\$871,175	\$744,792
Engineering Costs (20% for sewer and water)				\$1,936,000	\$0
			<b>Fee Subtotal</b>	<b>\$4,375,289</b>	<b>\$2,085,418</b>
<b>Total Phase 3 (On-Site &amp; Off-Site) Costs</b>				<b>\$49,466,073</b>	<b>\$21,226,581</b>
<b>Total Phase 3 Costs</b>					<b>\$70,692,654</b>
<b>TOTAL CLIBP (On-Site &amp; Off-Site) COSTS</b>				<b>\$182,854,881</b>	<b>\$67,059,025</b>
<b>TOTAL CLIBP COSTS</b>					<b>\$249,913,906</b>

## APPENDIX A

---

This page intentionally left blank

# APPENDIX B Crows Landing Industrial Business Park Enhanced Infrastructure Financing District Feasibility Analysis

## MEMORANDUM

To: Keith Boggs, Stanislaus County

From: Jamie Gomes and Russ Powell

Subject: Crows Landing Industrial Business Park Enhanced Infrastructure Financing District Feasibility Analysis; EPS #152117

Date: August 25, 2016

*The Economics of Land Use*



Infrastructure Financing Districts (IFDs) and Enhanced Infrastructure Financing Districts (EIFDs) are forms of Tax Increment Financing (TIF) that are available to local public entities in California. Local agencies may establish an IFD or an EIFD for a given project or geographic area to capture incremental increases in property tax revenue from future development. In the absence of the IFD or the EIFD, this revenue would accrue to the county's General Fund (or other property-taxing entity revenue fund). EIFD funds can be used for project-related infrastructure, including roads and utilities, as well as parks and housing. Unlike prior TIF/Redevelopment law in California, IFDs and EIFDs do not provide access to property tax revenue beyond the local jurisdiction's share.

Largely because IFDs can be difficult to enact, Senate Bill 628 created a similar but more flexible tool, the EIFD. The EIFD bill expands the scope of eligible projects considerably and lowers the voter/landowner threshold to pass a bond from two-thirds to 55 percent. In addition, EIFDs can be formed and gain access to unlevered (debt-free) revenue without a vote.

Stanislaus County (County) is in the process of considering several levels of entitlements for the Crows Landing Industrial Business Park Project (Project), which is located on the former Crows Landing Flight Facility/NASA Ames Research Center. Along with the entitlements, the County is exploring public financing options that it may implement to help fund backbone infrastructure and other public facilities for the Project. Specifically, along with the Crows Landing Industrial Business Park Specific Plan, the County is having a Public Facilities Financing Plan (Financing Plan) prepared to identify the mix of funding mechanisms and financing strategy for required backbone infrastructure.

*Economic & Planning Systems, Inc.*  
 400 Capitol Mall, 28th Floor  
 Sacramento, CA 95814  
 916 649 8010 tel  
 916 649 2070 fax

Oakland  
 Sacramento  
 Denver  
 Los Angeles

[www.epsys.com](http://www.epsys.com)

To further inform the Financing Plan and Infrastructure financing strategy, the County has engaged Economic & Planning Systems, Inc. (EPS) to evaluate the feasibility of forming an EIFD for the Project. EPS understands the results of this EIFD feasibility analysis will be incorporated into the aforementioned Project Financing Plan, which is being prepared by AECOM. The purpose of this memorandum is to summarize the results of the EIFD feasibility analysis.

### Summary of Findings

Based on the analysis, which is discussed in more detail below, EPS has these conclusions:

1. **A zero beginning assessed value base in the Project is favorable for EIFD formation.** Because Project property is County-owned, the beginning assessed value base is zero. Thus, any new assessed value increases following EIFD formation would create tax increment revenues that may be pledged to an EIFD.
2. **The County may legally form an EIFD because it owns all legal parcels that would be included in the EIFD at formation.** The County legally may form an EIFD pursuant to the EIFD legislation. Under the EIFD legislation, the County is considered the landowner or owner of land and, as such, may participate in the EIFD formation process if it owns all of the land included within the EIFD boundaries.
3. **An EIFD is feasible under a scenario where the land and future Project development were owned in fee-simple title by the end-user.** New assessed values created by vertical development on land sold by the County to an end-user would create enough tax increment to support an EIFD formation. The combination of existing assessed value conditions, the County's share of property tax revenues, and future development values (land and vertical development together) under this scenario make an EIFD favorable for infrastructure financing.
4. **An EIFD appears feasible under a ground-lease scenario if the term of the ground leases were at least 35 years or greater.** In ground-lease situations, the County Assessor would collect property taxes on the possessory interest in the property. When ground leases have terms of at least 35 years or greater, the County Assessor's office likely would determine the value of such long-term leases "as if" the project were owned in fee-simple title.
5. **An EIFD likely would be infeasible under a ground-lease scenario where the ground leases were for terms of less than 35 years.** In a short-term ground-lease scenario, the County Assessor may value the property using the net present value of the remaining lease term payments. Under such an approach, the remaining value of the future lease revenues continues to decline as the lease term matures. Having the potential for declining future assessed values (as possessory interest) would make an EIFD infeasible.
6. **If formed, an EIFD is not likely to include any additional taxing entities besides the County.** A review of the Assembly Bill 8 factors for the tax rate area within which the Project is located did not indicate any other taxing entities would benefit or provide value by participating in the EIFD. Participation in the EIFD by the County only, excluding any other taxing entities, also would simplify governance of the EIFD.



## **EIFD Analysis**

EPS understands that the County may wish to retain ownership of Project land throughout development of the Project and permit private development to occur through ground-lease transactions. While this is a commonly used disposition approach, it may present unique challenges as it relates to an EIFD formation.

EPS spoke with staff in the County Assessor's office to garner a better understanding of how the Assessor's Office may determine assessed values for the Project under the following potential property disposition approaches:

1. Disposition of Project land as fee-simple sales to private-sector developers.
2. Disposition of Project land through short-term ground leases (less than 35 years) to private-sector developers.
3. Disposition of Project land through long-term ground leases (greater than 35 years) to private-sector developers.

In the cases of ground-leasing, the private developer would be subject to a taxable possessory interest in public, non-taxable property. The taxable possessory interest is levied, collected, and used by the County in the same manner as general property taxes. However, the length of the ground lease directly may influence the manner in which the County Assessor would value the possessory interest. In a ground-lease scenario, assessed values will be established based on the values of any right retained by the private possessor, for the term of the ground lease, and not those values retained by the public entity, in this case, the County. Therefore, depending on the terms of the ground-lease transaction, assessed values established for a possessory interest could be considerably less than those established for a fee-simple property ownership.

Because the specific Project disposition strategy has not been formalized at this time, this EIFD feasibility analysis estimated property tax increment revenues available to the EIFD under the following two disposition scenarios:

1. Fee-simple sale to private developer (Fee-Simple Scenario).
2. Long-term ground lease (greater than 35 years) to a private developer (Possessory Interest Scenario).

### **Fee-Simple Scenario**

To inform assessed value assumptions for the Fee-Simple Scenario, EPS used CoStar and Loopnet to derive comparable industrial values for the Interstate 5 corridor for the County and San Joaquin County. EPS also reviewed County Assessor records for distribution centers located in Patterson to inform assumptions regarding valuation for new development in the Project.

Although the Specific Plan enables development of industrial, office, and commercial land uses, this analysis estimated future assessed value based on a slow and fast absorption period for only the industrial uses in the Project. A market analysis prepared by AECOM assumed a 30- to 40-year buildout of the Project. The absorption assumptions from this market analysis informed the slow (40 years) and fast (30 years) absorption scenarios in this analysis. EPS only evaluated

light industrial, warehousing, and distribution land uses for the purposes of establishing assessed values. The analysis did not evaluate potential office or aviation uses that may be developed in the Project.

### **Possessory Interest Scenario**

For the Possessory Interest Scenario, this analysis is based on the assumption the ground lease would be longer than 35 years. Under such conditions, the County Assessor's staff indicated the assessed values used for possessory interest likely would be evaluated "as if" the property was transacted under a fee-simple scenario. However, because it is uncertain whether the value under a ground-lease scenario would exactly equal a fee-simple transaction, this analysis assumed a 15-percent value discount for the Possessory Interest Scenario. This way, the EIFD feasibility analysis included a conservative scenario to inform the feasibility determination.

A short-term ground-lease scenario was not included in the Possessory Interest Scenario because it is possible that under such conditions the County Assessor may value the property using the net present value of the remaining lease term payments. Under such an approach, the remaining value of the future lease revenues continues to decline as the lease term matures. Having the potential for declining future assessed values (as possessory interest) would make an EIFD infeasible. Therefore, that situation was not examined in this analysis.

### **Analysis Framework**

EPS developed a model to test potential tax increment revenues streams that could be achieved for an EIFD under varying value assumptions and absorption timeframe. The framework of the analysis is discussed below.

### **Property Tax Increment to EIFD**

An EIFD works similarly to how redevelopment agencies functioned in the past. The County may elect to identify an area, in this case, the Project area, where the County would choose to use property tax revenues (and other available revenues of the County) to fund backbone infrastructure and other eligible public improvements and facilities. The intent would be to divert property tax revenues away from other uses to encourage economic development, to stimulate new Project development and to improve overall assessed values in the EIFD.

This feasibility analysis is based on the assumption that the County would apportion 75 percent of the property tax revenues towards funding for backbone infrastructure and other eligible facilities in the Project. The remaining 25 percent could be available to fund County-provided services in the Project. Property tax increment not used in the EIFD could be used to fund maintenance of Project-specific infrastructure and facilities such as street and safety light maintenance, landscape maintenance, or certain airport operating costs. The decision regarding use of the 25 percent of tax increment not pledged to EIFD infrastructure will be at the County's discretion.

As part of this work effort, EPS has not prepared a fiscal impact analysis to determine the fiscal impacts to the County from the Project area as property tax revenues are diverted from other public uses. Such a fiscal impact analysis would need to be conducted before the formation of an

EIFD. The fiscal impact analysis is required before formation of an EIFD to provide the County with an understanding of the impacts to public services that may occur by apportioning all or a part of the property tax revenues in an EIFD.

### **General Assumptions**

The EIFD feasibility analysis relied on a series of assumptions, some of which are described in more detail below.

#### **Property Ownership**

All land to be included in the EIFD is owned by the County and may be sold to private-party developers or may be leased to private developers through one or more ground leases.

#### **Beginning Assessed Value**

Because all land to be included in the EIFD is tax-exempt, the beginning assessed value is zero. This condition is very advantageous from an EIFD formation perspective because the property tax increment from all new assessed value created following EIFD formation would be available to be pledged to the EIFD.

#### **Absorption Assumptions**

A market analysis prepared by AECOM assumed a 30- to 40-year buildout of the Project. EPS used the Specific Plan to identify the acreage for light industrial/warehousing and distribution uses (699 acres) and allocated the annual acreage absorption equally over a 30-year and a 40-year period. To determine the annual absorption of new development, EPS assumed a 0.4 floor-to-area ratio (FAR) to project annual square footage of new development.

#### **Valuation Assumptions and Sources**

EPS used CoStar, Loopnet, and the records of the County Assessor to establish estimated developed values on a per-square-foot basis. Specifically, EPS looked at distribution centers located in Patterson to establish assumed values per square foot. For the Fee-Simple Scenario, this analysis is based on an assumed developed value for industrial property of \$100 per building square foot. For the Possessory Interest Scenario, this analysis is based on the assumption possessory interest valuation during a long-term ground lease would be \$85. The analysis estimated EIFD revenues using both valuation methodologies to establish a low and high assessed value scenario. EPS believes the valuation assumptions are conservative for the analysis. To reiterate, the analysis only considered the industrial land uses permitted in the Specific Plan and did not include any office, commercial, or aviation land uses in the new assessed value estimates.

#### **Assumptions Regarding Timing of Construction and Valuation**

The feasibility analysis is based on the assumption construction may begin in 2018; however, this assumption may be aggressive because the entitlement process is still incomplete. EPS assumed that for construction in a given calendar year, the associated assessed value subsequently would be picked up in the following fiscal year.

**Participating Public Agencies**

This feasibility analysis is based on the assumption that only the County would participate in contributing property tax increment to the EIFD without participation from any other taxing entities. Based on the AB 8 factors for the Project’s tax rate area, the County receives 28.37 percent of the property tax dollar. This feasibility analysis is based on the assumption that the County would contribute 75 percent of the property tax increment to the EIFD, with the County retaining 25 percent to fund public services in the EIFD (as discussed above). It is within the County’s discretion to dedicate 100 percent of the property tax increment to the EIFD, but doing so would leave zero property tax revenue available to fund County-provided services to the Project. While other taxing entities are assumed not likely to participate in an EIFD, final determination regarding participating entities would be made during the EIFD formation process.

**Other Considerations**

Because the primary purpose of this analysis was to determine whether an EIFD would be feasible, the analysis did not include evaluation of other County revenues that may be pledged to the EIFD. For example, there may be other property tax revenues, such a vehicle license fee in lieu of property tax revenues, which could be dedicated to the EIFD. If the County were to move forward with an EIFD formation process, all potential revenues would be evaluated.

**Discussion of Analysis and Tables**

The following tables show the feasibility analysis and assumptions:

**Table 1** shows tax increment, assessed value, and development assumptions for the analysis.

**Table 2** summarizes the findings of the analysis, showing annual estimated EIFD tax increment and cumulative EIFD for a 45-year period of time from EIFD formation. A fast and slow growth projection is shown for the Fee-Simple Scenario and Possessory Interest Scenario. Initial annual tax increment amounts are modest. There is a positive cash flow for each scenario through buildout. Note that this analysis does not show annual EIFD costs, such as costs of administration and any other incidental costs. Cumulative EIFD tax increments for 45 years range from \$132.8 million to \$194.9 million.

**Table 3** shows the assumptions, projected annual tax increment, and cumulative tax increment for a 45-year time period for the Fee-Simple Scenario using the fast growth projections. The model is based on the assumption growth will begin in 2018, but because associated new development will not be assigned assessed value until the following fiscal year, tax increment is not created until 2019. Growth assumptions for all scenarios will be discussed in the following tables. **Table 3** calculates the 1-percent property tax calculated for each fiscal year. From this, EPS calculates the County’s share (28.37 percent) of the 1-percent property tax. Finally, the analysis is based on the assumption 75 percent is allocated to the EIFD. **Table 3** shows annual tax increment projections and cumulative tax increment projections.

**Table 4** models the Fee-Simple Scenario for slow growth projections, using the same assumptions as shown in **Table 3**.

**Table 5** models the Possessory Interest Scenario with the fast growth projections and the same assumptions as shown in **Table 3**.

**Table 6** models the Possessory Interest Scenario for slow growth projections, using the same assumptions as shown in **Table 3**.

**Table 7** shows the projected assessed value for new development in each fiscal year and the increase in growth on a per-square-foot basis, using the buildout projections for each scenario shown in **Table 8**.

**Table 8** shows absorption assumptions for new development under a slow growth and fast growth scenario.

**Table A-1** shows comparable industrial developments in Patterson and the associated assessed value on a per-square-foot basis and per-acre basis. These assumptions are being used to inform the calculation of assessed value for new development.

## Conclusion and Next Steps

### Conclusion

As described herein, conditions are very favorable towards an EIFD formation for the Project. An EIFD would complement other sources of financing that are anticipated to be used in combination to help fund backbone infrastructure and other public facilities needed for Project development. This analysis shows that positive cash flows would result under each development scenario examined above. The cumulative property tax increment would enable the County to reimburse itself or another party for improvements funded during the initial phases of development or to pay for infrastructure improvements over time on a pay-as-you-go basis. The formation of an EIFD would be a useful tool to include in the Infrastructure Financing Plan for public improvements and also may work well in combination with a land-secured financing district such as a Mello-Roos Community Facilities District.

### Next Steps

If the Board of Supervisors (Board) chooses to pursue formation of an EIFD after review of the findings of this analysis, a "next steps" for such a formation process is presented below. Kronick Moskovitz, Tiedemann & Girard (KMTG) has prepared a timetable for an EIFD formation, which is attached to this analysis in **Appendix A**.

Following is a brief discussion of each step in the process.

#### Step 1: County Staff/Consultants

Before bringing the Resolution of Intent (ROI) to form an EIFD to the Board, the County would hire a Financing Team (Team) consisting of bond counsel, underwriter, financial advisor (as needed), engineer, and economist to assist in the preparation of documents for the ROI. The Team, working with County staff, will have prepared an EIFD boundary map, identified facilities to be financed, and prepared notices for filling of the two public membership positions for the Public Finance Authority (PFA). These two members of the public will serve on the Board of the PFA with three members of the Board.

**Step 2: First Board Meeting—Adopt ROI**

The ROI will describe the proposed EIFD and set a time and place for the public hearing.

**Step 3: Public Notification**

The County Clerk mails the ROI to PFA and “landowners,” which, in this case, is the County.

**Step 4: PFA directs the County to Prepare the Infrastructure Plan****Step 5: Designated Official or Consultant Prepare the Infrastructure Plan**

The Team assists County staff with the preparation of the Infrastructure Plan (Plan), which defines the proposed boundaries for the EIFD, describes public facilities required to development, findings that public facilities are of communitywide significance, a financing section, and goals the EIFD proposed to achieve. The financing section contains detailed analysis for maximum portion of tax increment revenue to be committed to the EIFD, a projection of tax revenues, a plan for financing public facilities, a limit of the total number of dollars that may be allocated to the EIFD, duration of EIFD, a fiscal impact analysis of costs to the County to provide facilities and services within the EIFD, and a plan for financing any potential costs.

EPS recommends that the fiscal impact analysis be prepared early in the development of the Plan to inform County officials of any potential fiscal concerns regarding formation of the EIFD.

**Step 6: Deliver Plan to Landowners****Step 7: PFA Publishes Notice of Public Hearing****Step 8: PFA Adopts Resolution Approving the Plan****Step 9: Public Hearing**

The PFA will welcome public discussion regarding the Plan. Once all testimony is considered, the PFA may consider the Resolution Proposing Adoption of the Plan.

**Step 10: PFA Adopted Ordinance Adopting the Plan and Forming the EIFD****Step 11: County Staff Published the Ordinance****Step 12: County Files CEQA Notice of Exemption in regards to EIFD Formation****Step 13: Ordinance becomes Effective**

If the PFA wishes to issue debt under the EIFD, the PFA will conduct such proceedings at some time after formation of the EIFD. The EIFD could be used to fund facilities through a “pay-as-you-go” basis and not authorize the issuance of bonds.

**DRAFT**

**Table 1  
Crows Landing Industrial Business Park EIFD Analysis  
Tax Increment, Assessed Value, and Development Assumptions**

Item	County
<b>Tax Increment</b>	
Year of EIFD Formation	2017
Tax Increment to County	28.37%
Assumed Percentage Of County Tax Increment to EIFD	75.00%
<b>New Development Annual Sales Price Increase</b>	3.00%
<b>Assessed Value per Building Square Foot</b>	
Commercial - Fee Simple Scenario	\$ 100
Industrial - Fee Simple Scenario	\$ 100
Commercial - Possessory Interest Scenario	\$ 85
Industrial - Possessory Interest Scenario	\$ 85
<b>Development Phasing</b>	
Beginning Year	2018
Number of Years Until Buildout (Slow Growth)	40
Number of Years Until Buildout (Fast Growth)	30
<b>Floor Area Ratio</b>	
Commercial	0.25
Industrial	0.40

*assump all*

Source: Stanislaus County Auditor-Controller, Stanislaus County Assessor, AECOM, and EPS

**Table 2**  
**Crows Landing Industrial Business Park EIFD Analysis**  
**Projected County Property Tax Increment Available for EIFD**

Year	Annual EIFD Tax Increment (Rounded)				Cumulative EIFD Tax Increment (Rounded)			
	Fee Simple Scenario		Possessory Interest Scenario		Fee Simple Scenario		Possessory Interest Scenario	
	Slow Growth	Fast Growth	Slow Growth	Fast Growth	Slow Growth	Fast Growth	Slow Growth	Fast Growth
2017	\$ 0	\$ 0	\$ 0	\$ 0	\$ 0	\$ 0	\$ 0	\$ 0
2018	\$ 65,000	\$ 86,000	\$ 55,000	\$ 73,000	\$ 65,000	\$ 86,000	\$ 55,000	\$ 73,000
2019	\$ 131,000	\$ 175,000	\$ 112,000	\$ 149,000	\$ 196,000	\$ 261,000	\$ 167,000	\$ 222,000
2020	\$ 202,000	\$ 270,000	\$ 172,000	\$ 229,000	\$ 398,000	\$ 531,000	\$ 339,000	\$ 451,000
2021	\$ 276,000	\$ 369,000	\$ 235,000	\$ 314,000	\$ 674,000	\$ 900,000	\$ 574,000	\$ 765,000
2022	\$ 355,000	\$ 475,000	\$ 302,000	\$ 403,000	\$ 1,029,000	\$ 1,375,000	\$ 876,000	\$ 1,168,000
2023	\$ 439,000	\$ 586,000	\$ 373,000	\$ 498,000	\$ 1,468,000	\$ 1,961,000	\$ 1,249,000	\$ 1,666,000
2024	\$ 527,000	\$ 704,000	\$ 448,000	\$ 598,000	\$ 1,995,000	\$ 2,665,000	\$ 1,697,000	\$ 2,264,000
2025	\$ 620,000	\$ 829,000	\$ 527,000	\$ 704,000	\$ 2,615,000	\$ 3,494,000	\$ 2,224,000	\$ 2,968,000
2026	\$ 718,000	\$ 960,000	\$ 610,000	\$ 815,000	\$ 3,333,000	\$ 4,454,000	\$ 2,834,000	\$ 3,783,000
2027	\$ 822,000	\$ 1,098,000	\$ 698,000	\$ 933,000	\$ 4,155,000	\$ 5,552,000	\$ 3,532,000	\$ 4,716,000
2028	\$ 931,000	\$ 1,244,000	\$ 790,000	\$ 1,056,000	\$ 5,086,000	\$ 6,796,000	\$ 4,322,000	\$ 5,772,000
2029	\$ 1,046,000	\$ 1,397,000	\$ 888,000	\$ 1,187,000	\$ 6,132,000	\$ 8,193,000	\$ 5,210,000	\$ 6,959,000
2030	\$ 1,167,000	\$ 1,559,000	\$ 991,000	\$ 1,324,000	\$ 7,299,000	\$ 9,752,000	\$ 6,201,000	\$ 8,283,000
2031	\$ 1,294,000	\$ 1,729,000	\$ 1,099,000	\$ 1,468,000	\$ 8,593,000	\$ 11,481,000	\$ 7,300,000	\$ 9,751,000
2032	\$ 1,428,000	\$ 1,908,000	\$ 1,212,000	\$ 1,620,000	\$ 10,021,000	\$ 13,389,000	\$ 8,512,000	\$ 11,371,000
2033	\$ 1,569,000	\$ 2,095,000	\$ 1,331,000	\$ 1,780,000	\$ 11,590,000	\$ 15,484,000	\$ 9,843,000	\$ 13,151,000
2034	\$ 1,716,000	\$ 2,293,000	\$ 1,457,000	\$ 1,948,000	\$ 13,306,000	\$ 17,777,000	\$ 11,300,000	\$ 15,099,000
2035	\$ 1,872,000	\$ 2,500,000	\$ 1,589,000	\$ 2,124,000	\$ 15,178,000	\$ 20,277,000	\$ 12,889,000	\$ 17,223,000
2036	\$ 2,035,000	\$ 2,718,000	\$ 1,727,000	\$ 2,309,000	\$ 17,213,000	\$ 22,995,000	\$ 14,616,000	\$ 19,532,000
2037	\$ 2,206,000	\$ 2,946,000	\$ 1,872,000	\$ 2,504,000	\$ 19,419,000	\$ 25,941,000	\$ 16,488,000	\$ 22,036,000
2038	\$ 2,386,000	\$ 3,186,000	\$ 2,025,000	\$ 2,708,000	\$ 21,805,000	\$ 29,127,000	\$ 18,513,000	\$ 24,744,000
2039	\$ 2,575,000	\$ 3,438,000	\$ 2,185,000	\$ 2,922,000	\$ 24,380,000	\$ 32,565,000	\$ 20,698,000	\$ 27,666,000
2040	\$ 2,773,000	\$ 3,702,000	\$ 2,352,000	\$ 3,146,000	\$ 27,153,000	\$ 36,267,000	\$ 23,050,000	\$ 30,812,000
2041	\$ 2,980,000	\$ 3,978,000	\$ 2,528,000	\$ 3,382,000	\$ 30,133,000	\$ 40,245,000	\$ 25,578,000	\$ 34,194,000
2042	\$ 3,197,000	\$ 4,268,000	\$ 2,712,000	\$ 3,628,000	\$ 33,330,000	\$ 44,513,000	\$ 28,290,000	\$ 37,822,000
2043	\$ 3,425,000	\$ 4,572,000	\$ 2,905,000	\$ 3,886,000	\$ 36,755,000	\$ 49,085,000	\$ 31,195,000	\$ 41,708,000
2044	\$ 3,664,000	\$ 4,890,000	\$ 3,107,000	\$ 4,157,000	\$ 40,419,000	\$ 53,975,000	\$ 34,302,000	\$ 45,865,000
2045	\$ 3,914,000	\$ 5,223,000	\$ 3,318,000	\$ 4,440,000	\$ 44,333,000	\$ 59,198,000	\$ 37,620,000	\$ 50,305,000
2046	\$ 4,176,000	\$ 5,571,000	\$ 3,540,000	\$ 4,736,000	\$ 48,509,000	\$ 64,769,000	\$ 41,160,000	\$ 55,041,000
2047	\$ 4,449,000	\$ 5,936,000	\$ 3,772,000	\$ 5,047,000	\$ 52,958,000	\$ 70,705,000	\$ 44,932,000	\$ 60,088,000
2048	\$ 4,736,000	\$ 6,318,000	\$ 4,014,000	\$ 5,371,000	\$ 57,694,000	\$ 77,023,000	\$ 48,946,000	\$ 65,459,000
2049	\$ 5,036,000	\$ 6,717,000	\$ 4,268,000	\$ 5,711,000	\$ 62,730,000	\$ 83,740,000	\$ 53,214,000	\$ 71,170,000
2050	\$ 5,349,000	\$ 7,135,000	\$ 4,533,000	\$ 6,066,000	\$ 68,079,000	\$ 90,875,000	\$ 57,747,000	\$ 77,236,000
2051	\$ 5,677,000	\$ 7,571,000	\$ 4,810,000	\$ 6,437,000	\$ 73,756,000	\$ 98,446,000	\$ 62,557,000	\$ 83,673,000
2052	\$ 6,019,000	\$ 8,028,000	\$ 5,100,000	\$ 6,825,000	\$ 79,775,000	\$ 106,474,000	\$ 67,657,000	\$ 90,498,000
2053	\$ 6,377,000	\$ 8,504,000	\$ 5,403,000	\$ 7,230,000	\$ 86,152,000	\$ 114,978,000	\$ 73,060,000	\$ 97,728,000
2054	\$ 6,752,000	\$ 9,003,000	\$ 5,720,000	\$ 7,654,000	\$ 92,904,000	\$ 123,981,000	\$ 78,780,000	\$ 105,382,000
2055	\$ 7,142,000	\$ 9,523,000	\$ 6,050,000	\$ 8,096,000	\$ 100,046,000	\$ 133,504,000	\$ 84,830,000	\$ 113,478,000
2056	\$ 7,551,000	\$ 10,066,000	\$ 6,396,000	\$ 8,558,000	\$ 107,597,000	\$ 143,570,000	\$ 91,226,000	\$ 122,036,000
2057	\$ 7,977,000	\$ 10,634,000	\$ 6,756,000	\$ 9,041,000	\$ 115,574,000	\$ 154,204,000	\$ 97,982,000	\$ 131,077,000
2058	\$ 8,422,000	\$ 11,226,000	\$ 7,133,000	\$ 9,544,000	\$ 123,996,000	\$ 165,430,000	\$ 105,115,000	\$ 140,621,000
2059	\$ 8,887,000	\$ 11,844,000	\$ 7,526,000	\$ 10,070,000	\$ 132,883,000	\$ 177,274,000	\$ 112,641,000	\$ 150,691,000
2060	\$ 9,372,000	\$ 12,489,000	\$ 7,936,000	\$ 10,619,000	\$ 142,255,000	\$ 189,763,000	\$ 120,577,000	\$ 161,310,000
2061	\$ 9,853,000	\$ 12,864,000	\$ 8,174,000	\$ 10,938,000	\$ 151,908,000	\$ 202,627,000	\$ 128,751,000	\$ 172,248,000

*ti sum all*



**Table 3**  
**Crows Landing Industrial Business Park EIFD Analysis**  
**Projected Tax Increment to EIFD - Fee Simple Scenario - Fast Growth**

**Fee Simple Scenario - Fast Growth**

Fiscal Year Ending	Beginning Assessed Value	Existing AV Growth	New AV Added [1]	Ending AV	Cumulative Growth in AV	Gross Tax Increment	County	Total EIFD	Cumulative EIFD Total
Formula	a	b=a*3%	c	d=a+b+c	d	e=d*1.0%	f=e*28.37%	g=f*75%	
	\$ 0	\$ 0	\$ 0	\$ 0	\$ 0	\$ 0	\$ 0	\$ 0	\$ 0
2017	\$ 0	\$ 0	\$ 40,600,000	\$ 40,600,000	\$ 40,600,000	\$ 406,000	\$ 115,183	\$ 86,388	\$ 86,388
2018	\$ 0	\$ 0	\$ 40,600,000	\$ 82,418,000	\$ 82,418,000	\$ 824,180	\$ 233,822	\$ 175,367	\$ 261,754
2019	\$ 40,600,000	\$ 1,218,000	\$ 40,600,000	\$ 126,630,540	\$ 126,630,540	\$ 1,266,905	\$ 359,425	\$ 269,569	\$ 531,323
2020	\$ 82,418,000	\$ 2,472,540	\$ 41,800,000	\$ 173,591,256	\$ 173,591,256	\$ 1,735,913	\$ 492,484	\$ 369,363	\$ 900,686
2021	\$ 126,630,540	\$ 3,800,716	\$ 43,100,000	\$ 223,198,994	\$ 223,198,994	\$ 2,231,990	\$ 633,222	\$ 474,917	\$ 1,375,602
2022	\$ 173,591,256	\$ 5,207,738	\$ 44,400,000	\$ 275,594,964	\$ 275,594,964	\$ 2,755,950	\$ 781,871	\$ 586,403	\$ 1,962,006
2023	\$ 223,198,994	\$ 6,695,970	\$ 45,700,000	\$ 330,962,813	\$ 330,962,813	\$ 3,309,628	\$ 938,951	\$ 704,214	\$ 2,666,219
2024	\$ 275,594,964	\$ 8,267,849	\$ 47,100,000	\$ 389,391,697	\$ 389,391,697	\$ 3,893,917	\$ 1,104,716	\$ 828,537	\$ 3,494,756
2025	\$ 330,962,813	\$ 9,928,884	\$ 48,500,000	\$ 451,073,448	\$ 451,073,448	\$ 4,510,734	\$ 1,279,709	\$ 959,782	\$ 4,454,538
2026	\$ 389,391,697	\$ 11,691,751	\$ 50,000,000	\$ 516,105,651	\$ 516,105,651	\$ 5,161,057	\$ 1,464,297	\$ 1,098,155	\$ 5,552,693
2027	\$ 451,073,448	\$ 13,532,203	\$ 51,500,000	\$ 584,588,821	\$ 584,588,821	\$ 5,845,888	\$ 1,658,496	\$ 1,243,872	\$ 6,796,565
2028	\$ 516,105,651	\$ 15,483,170	\$ 53,000,000	\$ 656,726,486	\$ 656,726,486	\$ 6,567,266	\$ 1,863,153	\$ 1,397,365	\$ 8,193,930
2029	\$ 584,588,821	\$ 17,537,665	\$ 54,600,000	\$ 732,628,280	\$ 732,628,280	\$ 7,326,283	\$ 2,078,488	\$ 1,558,866	\$ 9,752,796
2030	\$ 656,726,486	\$ 19,701,795	\$ 56,200,000	\$ 812,507,128	\$ 812,507,128	\$ 8,125,071	\$ 2,305,107	\$ 1,728,830	\$ 11,481,627
2031	\$ 732,628,280	\$ 21,978,848	\$ 57,900,000	\$ 896,482,342	\$ 896,482,342	\$ 8,964,823	\$ 2,543,347	\$ 1,907,510	\$ 13,389,137
2032	\$ 812,507,128	\$ 24,375,214	\$ 59,600,000	\$ 984,776,813	\$ 984,776,813	\$ 9,847,768	\$ 2,793,841	\$ 2,095,281	\$ 15,484,518
2033	\$ 896,482,342	\$ 26,894,474	\$ 61,400,000	\$ 1,077,520,117	\$ 1,077,520,117	\$ 10,775,201	\$ 3,056,957	\$ 2,292,718	\$ 17,777,236
2034	\$ 984,776,813	\$ 29,543,304	\$ 63,200,000	\$ 1,174,945,720	\$ 1,174,945,720	\$ 11,749,457	\$ 3,333,356	\$ 2,500,917	\$ 20,277,253
2035	\$ 1,077,520,117	\$ 32,325,604	\$ 65,100,000	\$ 1,277,294,092	\$ 1,277,294,092	\$ 12,772,941	\$ 3,623,722	\$ 2,717,791	\$ 22,995,044
2036	\$ 1,174,945,720	\$ 35,248,372	\$ 67,100,000	\$ 1,384,712,815	\$ 1,384,712,815	\$ 13,847,129	\$ 3,928,472	\$ 2,946,354	\$ 25,941,398
2037	\$ 1,277,294,092	\$ 38,318,823	\$ 69,100,000	\$ 1,497,454,302	\$ 1,497,454,302	\$ 14,974,543	\$ 4,248,323	\$ 3,186,242	\$ 29,127,640
2038	\$ 1,384,712,815	\$ 41,541,387	\$ 71,200,000	\$ 1,615,677,931	\$ 1,615,677,931	\$ 16,156,779	\$ 4,583,727	\$ 3,437,795	\$ 32,565,435
2039	\$ 1,497,454,302	\$ 44,923,629	\$ 73,300,000	\$ 1,739,648,269	\$ 1,739,648,269	\$ 17,396,483	\$ 4,935,434	\$ 3,701,576	\$ 36,267,011
2040	\$ 1,615,677,931	\$ 48,470,338	\$ 75,500,000	\$ 1,869,637,717	\$ 1,869,637,717	\$ 18,696,377	\$ 5,304,218	\$ 3,978,164	\$ 40,245,175
2041	\$ 1,739,648,269	\$ 52,189,448	\$ 77,800,000	\$ 2,006,826,849	\$ 2,006,826,849	\$ 20,068,268	\$ 5,690,591	\$ 4,267,943	\$ 44,513,118
2042	\$ 1,869,637,717	\$ 56,089,132	\$ 80,100,000	\$ 2,148,501,654	\$ 2,148,501,654	\$ 21,485,017	\$ 6,095,364	\$ 4,571,523	\$ 49,084,641
2043	\$ 2,006,826,849	\$ 60,174,805	\$ 82,500,000	\$ 2,297,956,704	\$ 2,297,956,704	\$ 22,979,567	\$ 6,519,372	\$ 4,889,529	\$ 53,974,170
2044	\$ 2,148,501,654	\$ 64,455,050	\$ 85,000,000	\$ 2,454,495,405	\$ 2,454,495,405	\$ 24,544,954	\$ 6,963,477	\$ 5,222,608	\$ 59,196,778
2045	\$ 2,297,956,704	\$ 68,938,701	\$ 87,600,000	\$ 2,618,330,267	\$ 2,618,330,267	\$ 26,183,303	\$ 7,428,282	\$ 5,571,211	\$ 64,767,989
2046	\$ 2,454,495,405	\$ 73,634,862	\$ 90,200,000	\$ 2,789,780,175	\$ 2,789,780,175	\$ 27,897,802	\$ 7,914,690	\$ 5,936,018	\$ 70,704,006
2047	\$ 2,618,330,267	\$ 78,549,908	\$ 92,900,000	\$ 2,969,173,581	\$ 2,969,173,581	\$ 29,691,736	\$ 8,423,635	\$ 6,317,726	\$ 77,021,732
2048	\$ 2,789,780,175	\$ 83,693,405	\$ 95,700,000	\$ 3,156,848,788	\$ 3,156,848,788	\$ 31,568,488	\$ 8,956,075	\$ 6,717,056	\$ 83,738,788
2049	\$ 2,969,173,581	\$ 89,075,207	\$ 98,600,000	\$ 3,353,154,252	\$ 3,353,154,252	\$ 33,531,543	\$ 9,512,999	\$ 7,134,749	\$ 90,873,538
2050	\$ 3,156,848,788	\$ 94,705,464	\$ 101,600,000	\$ 3,558,348,879	\$ 3,558,348,879	\$ 35,583,489	\$ 10,095,143	\$ 7,571,357	\$ 98,444,895
2051	\$ 3,353,154,252	\$ 100,594,628	\$ 104,600,000	\$ 3,772,799,346	\$ 3,772,799,346	\$ 37,727,993	\$ 10,703,545	\$ 8,027,659	\$ 106,472,553
2052	\$ 3,558,348,879	\$ 106,750,466	\$ 107,700,000	\$ 3,996,893,326	\$ 3,996,893,326	\$ 39,968,933	\$ 11,339,278	\$ 8,504,458	\$ 114,977,012
2053	\$ 3,772,799,346	\$ 113,183,980	\$ 110,900,000	\$ 4,230,989,826	\$ 4,230,989,826	\$ 42,309,898	\$ 12,003,445	\$ 9,002,584	\$ 123,979,596
2054	\$ 3,996,893,326	\$ 119,906,500	\$ 114,200,000	\$ 4,475,519,520	\$ 4,475,519,520	\$ 44,755,195	\$ 12,697,183	\$ 9,522,887	\$ 133,502,483
2055	\$ 4,230,989,826	\$ 126,929,695	\$ 117,600,000	\$ 4,730,885,106	\$ 4,730,885,106	\$ 47,308,851	\$ 13,421,663	\$ 10,066,247	\$ 143,568,730
2056	\$ 4,475,519,520	\$ 134,265,586	\$ 121,100,000	\$ 4,997,511,659	\$ 4,997,511,659	\$ 49,975,117	\$ 14,178,091	\$ 10,633,568	\$ 154,202,298
2057	\$ 4,730,885,106	\$ 141,926,553	\$ 124,700,000	\$ 5,275,837,009	\$ 5,275,837,009	\$ 52,758,370	\$ 14,967,708	\$ 11,225,751	\$ 165,428,079
2058	\$ 4,997,511,659	\$ 149,925,350	\$ 128,400,000	\$ 5,566,412,119	\$ 5,566,412,119	\$ 55,664,121	\$ 15,792,078	\$ 11,844,059	\$ 177,272,138
2059	\$ 5,275,837,009	\$ 159,275,110	\$ 132,300,000	\$ 5,869,704,483	\$ 5,869,704,483	\$ 58,697,045	\$ 16,652,528	\$ 12,489,396	\$ 189,761,533
2060	\$ 5,566,412,119	\$ 166,992,364	\$ 136,300,000	\$ 6,045,795,617	\$ 6,045,795,617	\$ 60,457,956	\$ 17,152,104	\$ 12,864,078	\$ 202,625,611
2061	\$ 5,869,704,483	\$ 176,091,134	\$ 0						

Source: Stanislaus County and EPS.

[1] Fast growth projection for land value included from Table 7.

DRAFT

**Table 4**  
**Crows Landing Industrial Business Park EIFD Analysis**  
**Projected Tax Increment to EIFD - Fee Simple Scenario - Slow Growth**

**Fee Simple Scenario - Slow Growth**

Fiscal Year Ending	Beginning Assessed Value	Existing AV Growth	New AV Added to Roll [1]	Ending AV	Cumulative Growth in AV	Gross Tax Increment	County		
							Total EIFD	Cumulative EIFD Total	
Formula	a	b=a*3%	c	d=a+b+c	d	e=d*1.0%	f=e*28.37%	g=f*75%	
2017	\$ 0	\$ 0	\$ 0	\$ 0	\$ 0	\$ 0	\$ 0	\$ 0	\$ 0
2018	\$ 0	\$ 0	\$ 30,400,000	\$ 30,400,000	\$ 30,400,000	\$ 304,000	\$ 86,246	\$ 64,684	\$ 64,684
2019	\$ 30,400,000	\$ 912,000	\$ 30,400,000	\$ 61,712,000	\$ 61,712,000	\$ 617,120	\$ 175,079	\$ 131,309	\$ 185,993
2020	\$ 61,712,000	\$ 1,851,360	\$ 31,300,000	\$ 94,863,360	\$ 94,863,360	\$ 948,634	\$ 269,130	\$ 201,848	\$ 397,841
2021	\$ 94,863,360	\$ 2,845,901	\$ 32,200,000	\$ 129,909,261	\$ 129,909,261	\$ 1,299,093	\$ 368,556	\$ 276,417	\$ 674,258
2022	\$ 129,909,261	\$ 3,897,278	\$ 33,200,000	\$ 167,006,539	\$ 167,006,539	\$ 1,670,065	\$ 473,803	\$ 355,352	\$ 1,029,610
2023	\$ 167,006,539	\$ 5,010,196	\$ 34,200,000	\$ 206,216,735	\$ 206,216,735	\$ 2,062,167	\$ 585,043	\$ 438,782	\$ 1,468,393
2024	\$ 206,216,735	\$ 6,186,502	\$ 35,200,000	\$ 247,603,237	\$ 247,603,237	\$ 2,476,032	\$ 702,458	\$ 526,843	\$ 1,996,236
2025	\$ 247,603,237	\$ 7,428,097	\$ 36,300,000	\$ 291,331,334	\$ 291,331,334	\$ 2,913,313	\$ 826,516	\$ 619,887	\$ 2,615,123
2026	\$ 291,331,334	\$ 8,739,940	\$ 37,400,000	\$ 337,471,274	\$ 337,471,274	\$ 3,374,713	\$ 957,416	\$ 718,062	\$ 3,333,185
2027	\$ 337,471,274	\$ 10,124,138	\$ 38,500,000	\$ 386,095,412	\$ 386,095,412	\$ 3,860,954	\$ 1,095,364	\$ 821,523	\$ 4,154,708
2028	\$ 386,095,412	\$ 11,582,862	\$ 39,700,000	\$ 437,378,275	\$ 437,378,275	\$ 4,373,783	\$ 1,240,855	\$ 930,641	\$ 5,085,350
2029	\$ 437,378,275	\$ 13,121,348	\$ 40,900,000	\$ 491,399,623	\$ 491,399,623	\$ 4,913,996	\$ 1,394,115	\$ 1,045,587	\$ 6,130,936
2030	\$ 491,399,623	\$ 14,741,969	\$ 42,100,000	\$ 548,241,611	\$ 548,241,611	\$ 5,482,416	\$ 1,555,378	\$ 1,168,533	\$ 7,297,470
2031	\$ 548,241,611	\$ 16,442,248	\$ 43,400,000	\$ 608,088,860	\$ 608,088,860	\$ 6,080,889	\$ 1,725,166	\$ 1,293,875	\$ 8,591,344
2032	\$ 608,088,860	\$ 18,242,666	\$ 44,700,000	\$ 671,031,526	\$ 671,031,526	\$ 6,710,315	\$ 1,903,737	\$ 1,427,802	\$ 10,019,147
2033	\$ 671,031,526	\$ 20,130,946	\$ 46,000,000	\$ 737,162,471	\$ 737,162,471	\$ 7,371,625	\$ 2,091,352	\$ 1,568,514	\$ 11,587,681
2034	\$ 737,162,471	\$ 22,114,874	\$ 47,400,000	\$ 806,677,345	\$ 806,677,345	\$ 8,066,773	\$ 2,289,588	\$ 1,716,426	\$ 13,304,087
2035	\$ 806,677,345	\$ 24,200,320	\$ 48,800,000	\$ 879,677,666	\$ 879,677,666	\$ 8,796,777	\$ 2,495,672	\$ 1,871,754	\$ 15,175,841
2036	\$ 879,677,666	\$ 26,390,330	\$ 50,300,000	\$ 958,367,996	\$ 958,367,996	\$ 9,583,680	\$ 2,713,245	\$ 2,034,934	\$ 17,210,774
2037	\$ 958,367,996	\$ 28,691,040	\$ 51,900,000	\$ 1,036,859,036	\$ 1,036,859,036	\$ 10,368,590	\$ 2,941,600	\$ 2,206,200	\$ 19,416,974
2038	\$ 1,036,859,036	\$ 31,105,771	\$ 53,400,000	\$ 1,121,364,807	\$ 1,121,364,807	\$ 11,213,648	\$ 3,181,346	\$ 2,386,009	\$ 21,802,983
2039	\$ 1,121,364,807	\$ 33,640,944	\$ 55,000,000	\$ 1,210,005,751	\$ 1,210,005,751	\$ 12,100,058	\$ 3,432,823	\$ 2,574,617	\$ 24,377,900
2040	\$ 1,210,005,751	\$ 36,300,173	\$ 56,700,000	\$ 1,303,005,924	\$ 1,303,005,924	\$ 13,030,059	\$ 3,696,667	\$ 2,772,500	\$ 27,150,101
2041	\$ 1,303,005,924	\$ 39,090,178	\$ 58,400,000	\$ 1,400,496,101	\$ 1,400,496,101	\$ 14,004,961	\$ 3,973,249	\$ 2,979,937	\$ 30,130,039
2042	\$ 1,400,496,101	\$ 42,014,883	\$ 60,200,000	\$ 1,502,710,984	\$ 1,502,710,984	\$ 15,027,110	\$ 4,263,236	\$ 3,197,427	\$ 33,327,465
2043	\$ 1,502,710,984	\$ 45,061,330	\$ 62,000,000	\$ 1,609,792,314	\$ 1,609,792,314	\$ 16,097,923	\$ 4,567,029	\$ 3,425,272	\$ 36,752,737
2044	\$ 1,609,792,314	\$ 48,263,769	\$ 63,900,000	\$ 1,721,986,083	\$ 1,721,986,083	\$ 17,219,861	\$ 4,885,326	\$ 3,663,995	\$ 40,416,731
2045	\$ 1,721,986,083	\$ 51,659,582	\$ 65,800,000	\$ 1,839,445,666	\$ 1,839,445,666	\$ 18,394,457	\$ 5,218,563	\$ 3,913,922	\$ 44,330,653
2046	\$ 1,839,445,666	\$ 55,183,370	\$ 67,900,000	\$ 1,962,429,036	\$ 1,962,429,036	\$ 19,624,290	\$ 5,567,470	\$ 4,175,603	\$ 48,506,256
2047	\$ 1,962,429,036	\$ 58,872,871	\$ 69,900,000	\$ 2,091,101,907	\$ 2,091,101,907	\$ 20,911,019	\$ 5,932,519	\$ 4,449,389	\$ 52,956,645
2048	\$ 2,091,101,907	\$ 62,733,057	\$ 71,900,000	\$ 2,225,734,964	\$ 2,225,734,964	\$ 22,257,350	\$ 6,314,477	\$ 4,735,958	\$ 57,691,502
2049	\$ 2,225,734,964	\$ 66,772,049	\$ 74,100,000	\$ 2,366,607,013	\$ 2,366,607,013	\$ 23,666,070	\$ 6,714,135	\$ 5,035,601	\$ 62,727,104
2050	\$ 2,366,607,013	\$ 70,988,210	\$ 76,300,000	\$ 2,513,905,223	\$ 2,513,905,223	\$ 25,139,052	\$ 7,132,025	\$ 5,349,018	\$ 68,076,122
2051	\$ 2,513,905,223	\$ 75,417,157	\$ 78,600,000	\$ 2,667,922,380	\$ 2,667,922,380	\$ 26,679,224	\$ 7,568,976	\$ 5,676,732	\$ 73,752,854
2052	\$ 2,667,922,380	\$ 80,037,671	\$ 81,000,000	\$ 2,828,960,051	\$ 2,828,960,051	\$ 28,289,601	\$ 8,025,845	\$ 6,019,393	\$ 79,772,237
2053	\$ 2,828,960,051	\$ 84,888,802	\$ 83,400,000	\$ 2,997,228,853	\$ 2,997,228,853	\$ 29,972,289	\$ 8,503,228	\$ 6,377,421	\$ 86,149,659
2054	\$ 2,997,228,853	\$ 89,916,866	\$ 85,900,000	\$ 3,173,045,718	\$ 3,173,045,718	\$ 31,730,457	\$ 9,002,026	\$ 6,751,519	\$ 92,901,178
2055	\$ 3,173,045,718	\$ 95,191,372	\$ 88,500,000	\$ 3,356,737,090	\$ 3,356,737,090	\$ 33,567,371	\$ 9,523,164	\$ 7,142,373	\$ 100,043,551
2056	\$ 3,356,737,090	\$ 100,702,113	\$ 91,200,000	\$ 3,548,639,203	\$ 3,548,639,203	\$ 35,486,392	\$ 10,067,596	\$ 7,550,697	\$ 107,594,248
2057	\$ 3,548,639,203	\$ 106,459,176	\$ 93,900,000	\$ 3,748,998,379	\$ 3,748,998,379	\$ 37,489,984	\$ 10,636,021	\$ 7,977,016	\$ 115,571,263
2058	\$ 3,748,998,379	\$ 112,469,951	\$ 96,700,000	\$ 3,958,168,330	\$ 3,958,168,330	\$ 39,581,683	\$ 11,229,442	\$ 8,422,082	\$ 123,993,345
2059	\$ 3,958,168,330	\$ 118,745,050	\$ 99,600,000	\$ 4,176,513,380	\$ 4,176,513,380	\$ 41,765,134	\$ 11,848,894	\$ 8,886,670	\$ 132,880,015
2060	\$ 4,176,513,380	\$ 125,295,401	\$ 102,600,000	\$ 4,404,408,781	\$ 4,404,408,781	\$ 44,044,088	\$ 12,495,440	\$ 9,371,580	\$ 142,251,595
2061	\$ 4,404,408,781	\$ 132,132,263	\$ 0	\$ 4,536,541,045	\$ 4,536,541,045	\$ 45,365,410	\$ 12,870,303	\$ 9,652,727	\$ 151,904,323

"tbl\_d\_62"

Source: AECOM and EPS.

[1] Slow growth projection for land value included from Table 7.

**DRAFT**

**Table 5**  
**Crows Landing Industrial Business Park EIFD Analysis**  
**Projected Tax Increment to EIFD - Possessory Interest Scenario - Fast Growth**

**Possessory Interest Scenario - Fast Growth**

Fiscal Year Ending	Beginning Assessed Value	Existing AV Growth	New AV Added to Roll [1]	Ending AV	Cumulative Growth in AV	Gross Tax Increment	County	Total EIFD	Cumulative EIFD Total
Formula	a	b=a*3%	c	d=a+b+c	d	e=d*1.0%	f=e*28.37%	g=f*75%	
2017	\$ 0	\$ 0	\$ 0	\$ 0	\$ 0	\$ 0	\$ 0	\$ 0	\$ 0
2018	\$ 0	\$ 0	\$ 34,510,000	\$ 34,510,000	\$ 34,510,000	\$ 345,100	\$ 97,908	\$ 73,429	\$ 73,429
2019	\$ 34,510,000	\$ 1,035,300	\$ 34,510,000	\$ 70,055,300	\$ 70,055,300	\$ 700,553	\$ 198,749	\$ 149,062	\$ 222,491
2020	\$ 70,055,300	\$ 2,101,659	\$ 35,500,000	\$ 107,656,959	\$ 107,656,959	\$ 1,076,570	\$ 305,425	\$ 229,070	\$ 451,561
2021	\$ 107,656,959	\$ 3,228,709	\$ 36,500,000	\$ 147,485,668	\$ 147,485,668	\$ 1,474,857	\$ 418,424	\$ 313,818	\$ 765,379
2022	\$ 147,485,668	\$ 4,424,800	\$ 37,700,000	\$ 189,611,268	\$ 189,611,268	\$ 1,896,113	\$ 537,933	\$ 403,450	\$ 1,168,828
2023	\$ 189,611,268	\$ 5,688,358	\$ 38,800,000	\$ 234,099,626	\$ 234,099,626	\$ 2,340,996	\$ 664,148	\$ 498,111	\$ 1,666,939
2024	\$ 234,099,626	\$ 7,022,980	\$ 40,000,000	\$ 281,122,594	\$ 281,122,594	\$ 2,811,226	\$ 797,559	\$ 598,165	\$ 2,265,104
2025	\$ 281,122,594	\$ 8,433,679	\$ 41,200,000	\$ 330,756,273	\$ 330,756,273	\$ 3,307,563	\$ 938,965	\$ 703,774	\$ 2,968,878
2026	\$ 330,756,272	\$ 9,922,688	\$ 42,400,000	\$ 383,078,960	\$ 383,078,960	\$ 3,830,790	\$ 1,098,807	\$ 815,195	\$ 3,783,983
2027	\$ 383,078,960	\$ 11,492,369	\$ 43,700,000	\$ 438,271,329	\$ 438,271,329	\$ 4,382,713	\$ 1,243,369	\$ 932,642	\$ 4,716,525
2028	\$ 438,271,329	\$ 13,148,140	\$ 45,000,000	\$ 496,419,469	\$ 496,419,469	\$ 4,964,195	\$ 1,408,557	\$ 1,058,268	\$ 5,772,792
2029	\$ 496,419,469	\$ 14,892,584	\$ 46,400,000	\$ 557,712,053	\$ 557,712,053	\$ 5,577,121	\$ 1,582,248	\$ 1,198,894	\$ 6,970,477
2030	\$ 557,712,053	\$ 16,731,362	\$ 47,800,000	\$ 622,243,414	\$ 622,243,414	\$ 6,222,434	\$ 1,765,323	\$ 1,323,992	\$ 8,293,469
2031	\$ 622,243,414	\$ 18,667,362	\$ 49,200,000	\$ 690,110,777	\$ 690,110,777	\$ 6,901,107	\$ 1,957,565	\$ 1,468,369	\$ 9,751,898
2032	\$ 690,110,777	\$ 20,703,322	\$ 50,700,000	\$ 761,514,099	\$ 761,514,099	\$ 7,615,140	\$ 2,160,438	\$ 1,620,829	\$ 11,372,726
2033	\$ 761,514,099	\$ 22,845,421	\$ 52,200,000	\$ 836,559,459	\$ 836,559,459	\$ 8,365,595	\$ 2,373,344	\$ 1,780,908	\$ 13,152,205
2034	\$ 836,559,459	\$ 25,096,784	\$ 53,800,000	\$ 915,456,243	\$ 915,456,243	\$ 9,154,562	\$ 2,597,177	\$ 1,947,893	\$ 15,100,087
2035	\$ 915,456,243	\$ 27,463,687	\$ 55,400,000	\$ 998,319,930	\$ 998,319,930	\$ 9,983,199	\$ 2,832,264	\$ 2,124,138	\$ 17,224,285
2036	\$ 998,319,930	\$ 29,949,598	\$ 57,100,000	\$ 1,085,369,528	\$ 1,085,369,528	\$ 10,853,695	\$ 3,079,226	\$ 2,308,419	\$ 19,532,704
2037	\$ 1,085,369,528	\$ 32,561,096	\$ 58,900,000	\$ 1,176,730,614	\$ 1,176,730,614	\$ 11,767,309	\$ 3,338,420	\$ 2,503,815	\$ 22,037,519
2038	\$ 1,176,730,614	\$ 35,301,918	\$ 60,800,000	\$ 1,272,632,533	\$ 1,272,632,533	\$ 12,726,325	\$ 3,610,497	\$ 2,797,873	\$ 24,745,392
2039	\$ 1,272,632,533	\$ 38,178,676	\$ 62,800,000	\$ 1,373,211,509	\$ 1,373,211,509	\$ 13,732,115	\$ 3,896,842	\$ 2,991,892	\$ 27,667,274
2040	\$ 1,373,211,509	\$ 41,196,345	\$ 64,900,000	\$ 1,478,707,854	\$ 1,478,707,854	\$ 14,787,079	\$ 4,196,139	\$ 3,146,354	\$ 30,813,628
2041	\$ 1,478,707,854	\$ 44,381,236	\$ 68,200,000	\$ 1,589,289,090	\$ 1,589,289,090	\$ 15,892,891	\$ 4,506,904	\$ 3,381,603	\$ 34,195,231
2042	\$ 1,589,289,090	\$ 47,678,073	\$ 68,200,000	\$ 1,705,147,162	\$ 1,705,147,162	\$ 17,051,472	\$ 4,837,554	\$ 3,628,165	\$ 37,823,396
2043	\$ 1,705,147,162	\$ 51,154,415	\$ 70,200,000	\$ 1,826,501,577	\$ 1,826,501,577	\$ 18,265,016	\$ 5,181,840	\$ 3,886,380	\$ 41,709,776
2044	\$ 1,826,501,577	\$ 54,795,047	\$ 72,300,000	\$ 1,953,596,624	\$ 1,953,596,624	\$ 19,535,966	\$ 5,542,412	\$ 4,156,269	\$ 45,866,585
2045	\$ 1,953,596,624	\$ 58,607,899	\$ 74,500,000	\$ 2,086,704,523	\$ 2,086,704,523	\$ 20,867,045	\$ 5,920,043	\$ 4,440,032	\$ 50,306,617
2046	\$ 2,086,704,523	\$ 62,601,136	\$ 76,700,000	\$ 2,226,005,659	\$ 2,226,005,659	\$ 22,260,057	\$ 6,315,245	\$ 4,736,434	\$ 55,043,051
2047	\$ 2,226,005,659	\$ 66,786,170	\$ 79,000,000	\$ 2,371,791,829	\$ 2,371,791,829	\$ 23,717,918	\$ 6,728,628	\$ 5,046,821	\$ 60,090,872
2048	\$ 2,371,791,829	\$ 71,153,575	\$ 81,400,000	\$ 2,524,339,403	\$ 2,524,339,403	\$ 25,243,394	\$ 7,161,627	\$ 5,371,220	\$ 65,462,092
2049	\$ 2,524,339,403	\$ 75,736,182	\$ 83,800,000	\$ 2,683,869,585	\$ 2,683,869,585	\$ 26,838,696	\$ 7,614,219	\$ 5,710,864	\$ 71,171,555
2050	\$ 2,683,869,585	\$ 80,516,088	\$ 86,300,000	\$ 2,850,685,673	\$ 2,850,685,673	\$ 28,506,857	\$ 8,087,481	\$ 6,085,611	\$ 77,257,166
2051	\$ 2,850,685,673	\$ 85,520,570	\$ 88,900,000	\$ 3,025,106,243	\$ 3,025,106,243	\$ 30,251,062	\$ 8,582,317	\$ 6,436,738	\$ 83,693,904
2052	\$ 3,025,106,243	\$ 90,753,187	\$ 91,600,000	\$ 3,207,459,431	\$ 3,207,459,431	\$ 32,074,594	\$ 9,099,858	\$ 6,824,744	\$ 90,498,648
2053	\$ 3,207,459,431	\$ 96,229,783	\$ 94,300,000	\$ 3,397,989,213	\$ 3,397,989,213	\$ 33,979,892	\$ 9,640,180	\$ 7,230,135	\$ 97,728,783
2054	\$ 3,397,989,213	\$ 101,938,495	\$ 97,100,000	\$ 3,597,022,710	\$ 3,597,022,710	\$ 35,970,227	\$ 10,204,861	\$ 7,653,848	\$ 105,382,429
2055	\$ 3,597,022,710	\$ 107,910,661	\$ 100,000,000	\$ 3,804,933,391	\$ 3,804,933,391	\$ 38,049,334	\$ 10,794,710	\$ 8,098,033	\$ 113,478,462
2056	\$ 3,804,933,391	\$ 114,149,092	\$ 103,000,000	\$ 4,022,081,393	\$ 4,022,081,393	\$ 40,220,814	\$ 11,410,786	\$ 8,568,074	\$ 122,046,536
2057	\$ 4,022,081,393	\$ 120,662,442	\$ 106,100,000	\$ 4,248,843,835	\$ 4,248,843,835	\$ 42,488,438	\$ 12,054,087	\$ 9,040,573	\$ 131,077,109
2058	\$ 4,248,843,835	\$ 127,495,315	\$ 109,300,000	\$ 4,485,639,150	\$ 4,485,639,150	\$ 44,856,391	\$ 12,725,808	\$ 9,544,368	\$ 140,621,465
2059	\$ 4,485,639,150	\$ 134,598,274	\$ 112,600,000	\$ 4,732,777,424	\$ 4,732,777,424	\$ 47,327,774	\$ 13,427,032	\$ 10,070,274	\$ 150,691,738
2060	\$ 4,732,777,424	\$ 141,985,323	\$ 116,000,000	\$ 4,990,760,747	\$ 4,990,760,747	\$ 49,907,607	\$ 14,158,369	\$ 10,619,203	\$ 161,310,942
2061	\$ 4,990,760,747	\$ 149,722,822	\$ 0	\$ 5,140,483,569	\$ 5,140,483,569	\$ 51,404,836	\$ 14,589,706	\$ 10,987,780	\$ 172,248,722

\$97\_831

Source: AECOM and EPS.

[1] Fast growth projection for possessory interest from Table 7.

DRAFT

**Table 6**  
**Crows Landing Industrial Business Park EIFD Analysis**  
**Projected Tax Increment to EIFD - Possessory Interest Scenario - Slow Growth**

Fiscal Year Ending	Beginning Assessed Value	Existing AV Growth	New AV Added to Roll [1]	Ending AV	Cumulative Growth in AV	Gross Tax Increment	Possessory Interest Scenario - Slow Growth		
							County	Total EIFD	Cumulative EIFD Total
Formula	a	b=a*9%	c	d=a+b+c	e	f=e*d*1.0%	g=f*28.37%	h=f*75%	i
2017	\$ 0	\$ 0	\$ 0	\$ 0	\$ 0	\$ 0	\$ 0	\$ 0	\$ 0
2018	\$ 0	\$ 0	\$ 25,840,000	\$ 25,840,000	\$ 25,840,000	\$ 258,400	\$ 73,306	\$ 54,982	\$ 54,982
2019	\$ 25,840,000	\$ 775,200	\$ 25,840,000	\$ 52,455,200	\$ 52,455,200	\$ 524,552	\$ 146,817	\$ 111,613	\$ 166,594
2020	\$ 52,455,200	\$ 1,573,656	\$ 26,900,000	\$ 80,628,856	\$ 80,628,856	\$ 806,289	\$ 226,746	\$ 171,560	\$ 338,154
2021	\$ 80,628,856	\$ 2,418,866	\$ 27,400,000	\$ 110,447,722	\$ 110,447,722	\$ 1,104,477	\$ 313,343	\$ 235,006	\$ 573,162
2022	\$ 110,447,722	\$ 3,313,432	\$ 28,200,000	\$ 141,961,153	\$ 141,961,153	\$ 1,419,612	\$ 402,749	\$ 302,061	\$ 675,223
2023	\$ 141,961,153	\$ 4,258,895	\$ 29,000,000	\$ 175,219,988	\$ 175,219,988	\$ 1,752,199	\$ 497,104	\$ 372,828	\$ 1,248,051
2024	\$ 175,219,988	\$ 5,256,600	\$ 29,900,000	\$ 210,376,588	\$ 210,376,588	\$ 2,103,766	\$ 596,845	\$ 447,834	\$ 1,695,686
2025	\$ 210,376,588	\$ 6,311,209	\$ 30,900,000	\$ 247,497,695	\$ 247,497,695	\$ 2,474,979	\$ 702,131	\$ 528,599	\$ 2,232,283
2026	\$ 247,497,695	\$ 7,424,637	\$ 31,700,000	\$ 296,612,522	\$ 296,612,522	\$ 2,966,125	\$ 813,129	\$ 609,246	\$ 2,832,129
2027	\$ 296,612,522	\$ 8,589,376	\$ 32,700,000	\$ 327,910,897	\$ 327,910,897	\$ 3,279,109	\$ 930,250	\$ 697,720	\$ 3,529,849
2028	\$ 327,910,897	\$ 9,857,327	\$ 33,700,000	\$ 371,448,224	\$ 371,448,224	\$ 3,714,482	\$ 1,050,510	\$ 786,357	\$ 4,320,208
2029	\$ 371,448,224	\$ 11,143,447	\$ 34,700,000	\$ 417,291,671	\$ 417,291,671	\$ 4,172,917	\$ 1,193,969	\$ 897,902	\$ 5,209,108
2030	\$ 417,291,671	\$ 12,519,750	\$ 35,700,000	\$ 465,510,421	\$ 465,510,421	\$ 4,655,104	\$ 1,320,667	\$ 990,500	\$ 6,199,606
2031	\$ 465,510,421	\$ 13,995,313	\$ 36,900,000	\$ 516,275,734	\$ 516,275,734	\$ 5,162,757	\$ 1,464,993	\$ 1,098,517	\$ 7,297,125
2032	\$ 516,275,734	\$ 15,483,272	\$ 37,900,000	\$ 569,664,006	\$ 569,664,006	\$ 5,696,640	\$ 1,616,154	\$ 1,212,115	\$ 8,509,241
2033	\$ 569,664,006	\$ 17,089,920	\$ 39,000,000	\$ 625,753,926	\$ 625,753,926	\$ 6,257,539	\$ 1,775,293	\$ 1,331,462	\$ 9,840,703
2034	\$ 625,753,926	\$ 18,772,618	\$ 40,200,000	\$ 684,726,544	\$ 684,726,544	\$ 6,847,265	\$ 1,942,590	\$ 1,456,942	\$ 11,297,645
2035	\$ 684,726,544	\$ 20,541,795	\$ 41,400,000	\$ 746,668,340	\$ 746,668,340	\$ 7,466,683	\$ 2,118,320	\$ 1,588,740	\$ 12,906,385
2036	\$ 746,668,340	\$ 22,409,050	\$ 42,600,000	\$ 811,668,390	\$ 811,668,390	\$ 8,116,684	\$ 2,302,728	\$ 1,727,046	\$ 14,613,431
2037	\$ 811,668,390	\$ 24,356,052	\$ 43,900,000	\$ 879,918,442	\$ 879,918,442	\$ 8,799,184	\$ 2,496,355	\$ 1,872,286	\$ 16,485,697
2038	\$ 879,918,442	\$ 26,397,553	\$ 45,200,000	\$ 951,515,995	\$ 951,515,995	\$ 9,515,160	\$ 2,699,479	\$ 2,024,810	\$ 18,510,307
2039	\$ 951,515,995	\$ 28,545,480	\$ 46,600,000	\$ 1,028,861,475	\$ 1,028,861,475	\$ 10,286,615	\$ 2,912,808	\$ 2,184,502	\$ 20,694,809
2040	\$ 1,028,861,475	\$ 30,799,844	\$ 48,000,000	\$ 1,105,461,319	\$ 1,105,461,319	\$ 11,054,613	\$ 3,136,227	\$ 2,352,170	\$ 23,046,979
2041	\$ 1,105,461,319	\$ 33,183,840	\$ 49,400,000	\$ 1,188,025,159	\$ 1,188,025,159	\$ 11,880,252	\$ 3,370,493	\$ 2,527,847	\$ 25,574,826
2042	\$ 1,188,025,159	\$ 35,640,755	\$ 50,900,000	\$ 1,274,565,914	\$ 1,274,565,914	\$ 12,745,659	\$ 3,615,962	\$ 2,711,968	\$ 28,288,813
2043	\$ 1,274,565,914	\$ 38,236,977	\$ 52,400,000	\$ 1,365,202,891	\$ 1,365,202,891	\$ 13,652,029	\$ 3,873,122	\$ 2,904,841	\$ 31,191,654
2044	\$ 1,365,202,891	\$ 40,956,067	\$ 54,000,000	\$ 1,460,158,978	\$ 1,460,158,978	\$ 14,601,590	\$ 4,142,515	\$ 3,106,886	\$ 34,298,540
2045	\$ 1,460,158,978	\$ 43,804,789	\$ 55,800,000	\$ 1,569,563,747	\$ 1,569,563,747	\$ 15,595,637	\$ 4,424,529	\$ 3,312,397	\$ 37,616,937
2046	\$ 1,569,563,747	\$ 46,786,912	\$ 57,900,000	\$ 1,683,650,690	\$ 1,683,650,690	\$ 16,836,507	\$ 4,719,627	\$ 3,539,870	\$ 41,156,807
2047	\$ 1,683,650,690	\$ 49,909,620	\$ 59,000,000	\$ 1,772,960,179	\$ 1,772,960,179	\$ 17,726,602	\$ 5,020,906	\$ 3,771,605	\$ 44,938,412
2048	\$ 1,772,960,179	\$ 53,176,805	\$ 60,900,000	\$ 1,886,536,985	\$ 1,886,536,985	\$ 18,865,370	\$ 5,352,162	\$ 4,014,122	\$ 49,342,533
2049	\$ 1,886,536,985	\$ 56,596,110	\$ 62,900,000	\$ 2,005,733,094	\$ 2,005,733,094	\$ 20,057,331	\$ 5,690,325	\$ 4,267,744	\$ 53,210,277
2050	\$ 2,005,733,094	\$ 60,171,803	\$ 64,500,000	\$ 2,130,405,087	\$ 2,130,405,087	\$ 21,304,051	\$ 6,044,023	\$ 4,530,017	\$ 57,745,294
2051	\$ 2,130,405,087	\$ 63,912,193	\$ 66,400,000	\$ 2,260,717,240	\$ 2,260,717,240	\$ 22,607,172	\$ 6,413,723	\$ 4,810,292	\$ 62,553,596
2052	\$ 2,260,717,240	\$ 67,823,517	\$ 68,400,000	\$ 2,396,936,757	\$ 2,396,936,757	\$ 23,969,368	\$ 6,800,187	\$ 5,100,140	\$ 67,653,727
2053	\$ 2,396,936,757	\$ 71,908,163	\$ 70,500,000	\$ 2,539,348,920	\$ 2,539,348,920	\$ 25,393,469	\$ 7,204,203	\$ 5,403,153	\$ 73,056,879
2054	\$ 2,539,348,920	\$ 76,180,408	\$ 72,900,000	\$ 2,688,127,327	\$ 2,688,127,327	\$ 26,881,273	\$ 7,626,298	\$ 5,719,723	\$ 78,776,603
2055	\$ 2,688,127,327	\$ 80,743,820	\$ 74,800,000	\$ 2,843,571,147	\$ 2,843,571,147	\$ 28,435,711	\$ 8,067,297	\$ 6,060,472	\$ 84,827,075
2056	\$ 2,843,571,147	\$ 85,607,134	\$ 77,000,000	\$ 3,005,978,282	\$ 3,005,978,282	\$ 30,059,783	\$ 8,527,787	\$ 6,395,825	\$ 91,222,900
2057	\$ 3,005,978,282	\$ 90,176,348	\$ 79,300,000	\$ 3,175,354,630	\$ 3,175,354,630	\$ 31,753,546	\$ 9,008,576	\$ 6,756,432	\$ 97,979,333
2058	\$ 3,175,354,630	\$ 95,260,869	\$ 81,700,000	\$ 3,352,315,269	\$ 3,352,315,269	\$ 33,523,153	\$ 9,510,619	\$ 7,130,364	\$ 105,112,297
2059	\$ 3,352,315,269	\$ 100,598,459	\$ 84,200,000	\$ 3,537,094,727	\$ 3,537,094,727	\$ 35,370,947	\$ 10,034,815	\$ 7,526,112	\$ 112,638,406
2060	\$ 3,537,094,727	\$ 106,112,542	\$ 88,700,000	\$ 3,729,897,269	\$ 3,729,897,269	\$ 37,298,973	\$ 10,591,830	\$ 7,996,373	\$ 120,574,781
2061	\$ 3,729,897,269	\$ 111,896,918	\$ 0	\$ 3,841,794,187	\$ 3,841,794,187	\$ 38,417,942	\$ 10,850,285	\$ 8,174,464	\$ 128,749,245

Source: AECOM and EPS.

[1] Slow growth projection for possessory interest from **Table 7**.

14

**Table 7**  
**Crows Landing Industrial Business Park EIFD Analysis**  
**Assessed Value of New Development**

Fiscal Year Ending	Fee Simple Scenario		Long Term Lease Possessory Interest Scenario		Fee Simple Scenario		Long Term Lease Possessory Interest Scenario	
	Slow Growth Industrial	Fast Growth Industrial	Slow Growth Industrial	Fast Growth Industrial	Annual Sales Price Increase Slow Growth	Annual Sales Price Increase Fast Growth	Annual Sales Price Increase Slow Growth	Annual Sales Price Increase Fast Growth
	AV per Bldg. Sq. Ft.		AV per Bldg. Sq. Ft.		rounded			
Assumption	\$ 100	\$ 100	\$ 85	\$ 85	3.0%	3.0%	3.0%	3.0%
2017	\$ 0	\$ 0	\$ 0	\$ 0	\$ 0	\$ 0	\$ 0	\$ 0
2018	\$ 30,400,000	\$ 40,600,000	\$ 25,840,000	\$ 34,510,000	\$ 30,400,000	\$ 40,600,000	\$ 25,840,000	\$ 34,510,000
2019	\$ 30,400,000	\$ 40,600,000	\$ 25,840,000	\$ 34,510,000	\$ 30,400,000	\$ 40,600,000	\$ 25,840,000	\$ 34,510,000
2020	\$ 30,400,000	\$ 40,600,000	\$ 25,840,000	\$ 34,510,000	\$ 31,300,000	\$ 41,800,000	\$ 26,600,000	\$ 35,500,000
2021	\$ 30,400,000	\$ 40,600,000	\$ 25,840,000	\$ 34,510,000	\$ 32,200,000	\$ 43,100,000	\$ 27,400,000	\$ 36,600,000
2022	\$ 30,400,000	\$ 40,600,000	\$ 25,840,000	\$ 34,510,000	\$ 33,200,000	\$ 44,400,000	\$ 28,200,000	\$ 37,700,000
2023	\$ 30,400,000	\$ 40,600,000	\$ 25,840,000	\$ 34,510,000	\$ 34,200,000	\$ 45,700,000	\$ 29,000,000	\$ 38,800,000
2024	\$ 30,400,000	\$ 40,600,000	\$ 25,840,000	\$ 34,510,000	\$ 35,200,000	\$ 47,100,000	\$ 29,900,000	\$ 40,000,000
2025	\$ 30,400,000	\$ 40,600,000	\$ 25,840,000	\$ 34,510,000	\$ 36,300,000	\$ 48,500,000	\$ 30,800,000	\$ 41,200,000
2026	\$ 30,400,000	\$ 40,600,000	\$ 25,840,000	\$ 34,510,000	\$ 37,400,000	\$ 50,000,000	\$ 31,700,000	\$ 42,400,000
2027	\$ 30,400,000	\$ 40,600,000	\$ 25,840,000	\$ 34,510,000	\$ 38,500,000	\$ 51,500,000	\$ 32,700,000	\$ 43,700,000
2028	\$ 30,400,000	\$ 40,600,000	\$ 25,840,000	\$ 34,510,000	\$ 39,700,000	\$ 53,000,000	\$ 33,700,000	\$ 45,000,000
2029	\$ 30,400,000	\$ 40,600,000	\$ 25,840,000	\$ 34,510,000	\$ 40,900,000	\$ 54,600,000	\$ 34,700,000	\$ 46,400,000
2030	\$ 30,400,000	\$ 40,600,000	\$ 25,840,000	\$ 34,510,000	\$ 42,100,000	\$ 56,200,000	\$ 35,700,000	\$ 47,800,000
2031	\$ 30,400,000	\$ 40,600,000	\$ 25,840,000	\$ 34,510,000	\$ 43,400,000	\$ 57,900,000	\$ 36,800,000	\$ 49,200,000
2032	\$ 30,400,000	\$ 40,600,000	\$ 25,840,000	\$ 34,510,000	\$ 44,700,000	\$ 59,600,000	\$ 37,900,000	\$ 50,700,000
2033	\$ 30,400,000	\$ 40,600,000	\$ 25,840,000	\$ 34,510,000	\$ 46,000,000	\$ 61,400,000	\$ 39,000,000	\$ 52,200,000
2034	\$ 30,400,000	\$ 40,600,000	\$ 25,840,000	\$ 34,510,000	\$ 47,400,000	\$ 63,200,000	\$ 40,200,000	\$ 53,800,000
2035	\$ 30,400,000	\$ 40,600,000	\$ 25,840,000	\$ 34,510,000	\$ 48,800,000	\$ 65,100,000	\$ 41,400,000	\$ 55,400,000
2036	\$ 30,400,000	\$ 40,600,000	\$ 25,840,000	\$ 34,510,000	\$ 50,300,000	\$ 67,100,000	\$ 42,600,000	\$ 57,100,000
2037	\$ 30,400,000	\$ 40,600,000	\$ 25,840,000	\$ 34,510,000	\$ 51,800,000	\$ 69,100,000	\$ 43,900,000	\$ 58,800,000
2038	\$ 30,400,000	\$ 40,600,000	\$ 25,840,000	\$ 34,510,000	\$ 53,400,000	\$ 71,200,000	\$ 45,200,000	\$ 60,600,000
2039	\$ 30,400,000	\$ 40,600,000	\$ 25,840,000	\$ 34,510,000	\$ 55,000,000	\$ 73,300,000	\$ 46,600,000	\$ 62,400,000
2040	\$ 30,400,000	\$ 40,600,000	\$ 25,840,000	\$ 34,510,000	\$ 56,700,000	\$ 75,500,000	\$ 48,000,000	\$ 64,300,000
2041	\$ 30,400,000	\$ 40,600,000	\$ 25,840,000	\$ 34,510,000	\$ 58,400,000	\$ 77,800,000	\$ 49,400,000	\$ 66,200,000
2042	\$ 30,400,000	\$ 40,600,000	\$ 25,840,000	\$ 34,510,000	\$ 60,200,000	\$ 80,100,000	\$ 50,900,000	\$ 68,200,000
2043	\$ 30,400,000	\$ 40,600,000	\$ 25,840,000	\$ 34,510,000	\$ 62,000,000	\$ 82,500,000	\$ 52,400,000	\$ 70,200,000
2044	\$ 30,400,000	\$ 40,600,000	\$ 25,840,000	\$ 34,510,000	\$ 63,900,000	\$ 85,000,000	\$ 54,000,000	\$ 72,300,000
2045	\$ 30,400,000	\$ 40,600,000	\$ 25,840,000	\$ 34,510,000	\$ 65,800,000	\$ 87,600,000	\$ 55,600,000	\$ 74,500,000
2046	\$ 30,400,000	\$ 40,600,000	\$ 25,840,000	\$ 34,510,000	\$ 67,800,000	\$ 90,200,000	\$ 57,300,000	\$ 76,700,000
2047	\$ 30,400,000	\$ 40,600,000	\$ 25,840,000	\$ 34,510,000	\$ 69,800,000	\$ 92,900,000	\$ 59,000,000	\$ 79,000,000
2048	\$ 30,400,000	\$ 0	\$ 25,840,000	\$ 0	\$ 71,900,000	\$ 95,700,000	\$ 60,800,000	\$ 81,400,000
2049	\$ 30,400,000	\$ 0	\$ 25,840,000	\$ 0	\$ 74,100,000	\$ 98,600,000	\$ 62,600,000	\$ 83,800,000
2050	\$ 30,400,000	\$ 0	\$ 25,840,000	\$ 0	\$ 76,300,000	\$ 101,600,000	\$ 64,500,000	\$ 86,300,000
2051	\$ 30,400,000	\$ 0	\$ 25,840,000	\$ 0	\$ 78,600,000	\$ 104,600,000	\$ 66,400,000	\$ 88,900,000
2052	\$ 30,400,000	\$ 0	\$ 25,840,000	\$ 0	\$ 81,000,000	\$ 107,700,000	\$ 68,400,000	\$ 91,600,000
2053	\$ 30,400,000	\$ 0	\$ 25,840,000	\$ 0	\$ 83,400,000	\$ 110,900,000	\$ 70,500,000	\$ 94,300,000
2054	\$ 30,400,000	\$ 0	\$ 25,840,000	\$ 0	\$ 85,900,000	\$ 114,200,000	\$ 72,600,000	\$ 97,100,000
2055	\$ 30,400,000	\$ 0	\$ 25,840,000	\$ 0	\$ 88,500,000	\$ 117,600,000	\$ 74,800,000	\$ 100,000,000
2056	\$ 30,400,000	\$ 0	\$ 25,840,000	\$ 0	\$ 91,200,000	\$ 121,100,000	\$ 77,000,000	\$ 103,000,000
2057	\$ 30,400,000	\$ 0	\$ 25,840,000	\$ 0	\$ 93,900,000	\$ 124,700,000	\$ 79,300,000	\$ 106,100,000
2058	\$ 0	\$ 0	\$ 0	\$ 0	\$ 96,700,000	\$ 128,400,000	\$ 81,700,000	\$ 109,300,000
2059	\$ 0	\$ 0	\$ 0	\$ 0	\$ 99,600,000	\$ 132,300,000	\$ 84,200,000	\$ 112,600,000
2060	\$ 0	\$ 0	\$ 0	\$ 0	\$ 102,600,000	\$ 136,300,000	\$ 86,700,000	\$ 116,000,000

Source: Stanislaus County and EPS.

AV new u

[1] See Table 8 for development projections.

**DRAFT**

**Table 8  
Crows Landing Industrial Business Park EIFD Analysis  
Projected Nonresidential Building Square Feet**

Fiscal Year Ending	Acres [1]		Building Square Feet	
	Slow Growth Industrial	Fast Growth Industrial	Slow Growth Industrial	Fast Growth Industrial
	Total Acres FAR	699	699	0.40
2018	17.5	23.3	304,000	406,000
2019	17.5	23.3	304,000	406,000
2020	17.5	23.3	304,000	406,000
2021	17.5	23.3	304,000	406,000
2022	17.5	23.3	304,000	406,000
2023	17.5	23.3	304,000	406,000
2024	17.5	23.3	304,000	406,000
2025	17.5	23.3	304,000	406,000
2026	17.5	23.3	304,000	406,000
2027	17.5	23.3	304,000	406,000
2028	17.5	23.3	304,000	406,000
2029	17.5	23.3	304,000	406,000
2030	17.5	23.3	304,000	406,000
2031	17.5	23.3	304,000	406,000
2032	17.5	23.3	304,000	406,000
2033	17.5	23.3	304,000	406,000
2034	17.5	23.3	304,000	406,000
2035	17.5	23.3	304,000	406,000
2036	17.5	23.3	304,000	406,000
2037	17.5	23.3	304,000	406,000
2038	17.5	23.3	304,000	406,000
2039	17.5	23.3	304,000	406,000
2040	17.5	23.3	304,000	406,000
2041	17.5	23.3	304,000	406,000
2042	17.5	23.3	304,000	406,000
2043	17.5	23.3	304,000	406,000
2044	17.5	23.3	304,000	406,000
2045	17.5	23.3	304,000	406,000
2046	17.5	23.3	304,000	406,000
2047	17.5	23.3	304,000	406,000
2048	17.5	0.0	304,000	0
2049	17.5	0.0	304,000	0
2050	17.5	0.0	304,000	0
2051	17.5	0.0	304,000	0
2052	17.5	0.0	304,000	0
2053	17.5	0.0	304,000	0
2054	17.5	0.0	304,000	0
2055	17.5	0.0	304,000	0
2056	17.5	0.0	304,000	0
2057	17.5	0.0	304,000	0
2058	0.0	0.0	0	0
2059	0.0	0.0	0	0
2060	0.0	0.0	0	0
2061	0.0	0.0	0	0
<b>Total [2]</b>	<b>699.0</b>	<b>699.0</b>	<b>12,160,000</b>	<b>12,180,000</b>

<sup>"Build\_out"</sup>

[1] The Crows Landing Industrial Business Park Specific Plan identified 699 acres for Logistics/Distribution and Light Industrial uses.

[2] Totals are not equal as a result of rounding square footage to the nearest 1,000 square feet annually.

Source: AECOM and EPS.

**DRAFT**

**Table A-1  
Crow's Landing Industrial Business Park EIFD Analysis  
Patterson Industrial Development Comps**

APN	Owner	Land Value	Improvement Value	Other Value	Total Value	Year Built	Building Area [1]	Lot Acres	Value/SF	Value/Acre
021-085-014	Kohls Department Stores Inc	\$9,279,000	\$27,295,500	\$9,093,490	\$45,667,990	2006	396,402	62.64	\$115.21	\$729,054.76
021-085-021	Longs Drug Stores California Inc	\$7,900,434	\$38,899,011	\$16,003,540	\$62,802,985	2006	809,971	51.30	\$77.54	\$1,224,229.73
021-085-024	LBA RV-Company XVII LP	\$4,650,000	\$23,750,000	\$0	\$28,400,000	2008	529,970	28.41	\$53.59	\$999,648.01
021-085-028	W W Grainger Inc	\$12,820,410	\$51,008,261	\$30,172,170	\$94,000,841	n/a	801,330	45.99	\$117.31	\$2,043,940.88
021-022-053	WR Griffin Patterson LLC	\$15,545,446	\$82,688,000	\$0	\$98,233,446	n/a	1,631,932	93.66	\$60.19	\$1,048,830.30

"comps"

[1] Actual square footage was not available in the Assessor's records. EPS used an assumed 0.4 FAR to estimate square footage.

Source: Stanislaus County Assessor.

A-1

This page intentionally left blank



## APPENDIX C

# Crows Landing Industrial Business Park, Industrial - Market Update

**AECOM**

AECOM 619 610 7705 tel  
401 West A Street 619 610 7601 fax  
Suite 1200  
San Diego, CA 92101  
www.aecom.com

---

Date: September 23, 2016

To: Keith Boggs, Assistant Executive Officer, Stanislaus County

From: Paul Peninger, Principal  
Alex Norr, Associate

Subject: Crows Landing Industrial Business Park, Industrial - Market Update

---

### Overview

The following memorandum serves as an update to the *Industrial Market Overview* section of the *Crows Landing Industrial Business Park Market and Absorption Analysis* (September 2014). AECOM evaluated and updated the real estate market fundamentals (i.e. vacancy rates, rental rates, historical development trends, etc.) for the relevant industrial market and submarket areas to provide insight into potential supply factors that may affect the long-term industrial development opportunities for the Crows Land Industrial Business Park site (CLIBP).<sup>1</sup> All figures are presented in current dollars (not adjusted for inflation).

Industrial real estate (includes warehouse and flex product types) market statistics are provided for the primary market area, defined as San Joaquin and Stanislaus counties, as well as for the associated industrial submarkets (Table 2, page 3). Despite the similar industrial characteristics of the primary market, it is important to note the influence the geographic diversity and the proximity to major transportation corridors have on the performance of the relevant submarkets. See the previous market analysis for greater detail on the trends in product type and competitive factors that contribute to the individual submarket's performance.

Given the proximity of the CLIBP to the Patterson submarket, and the expected similar industrial tenancy, submarket-specific metrics are highlighted to provide for a more focused comparison.

---

<sup>1</sup> Data presented within this document were derived from third-party sources; all findings are subject the General and Limiting Conditions detailed on page 8 of this memorandum.

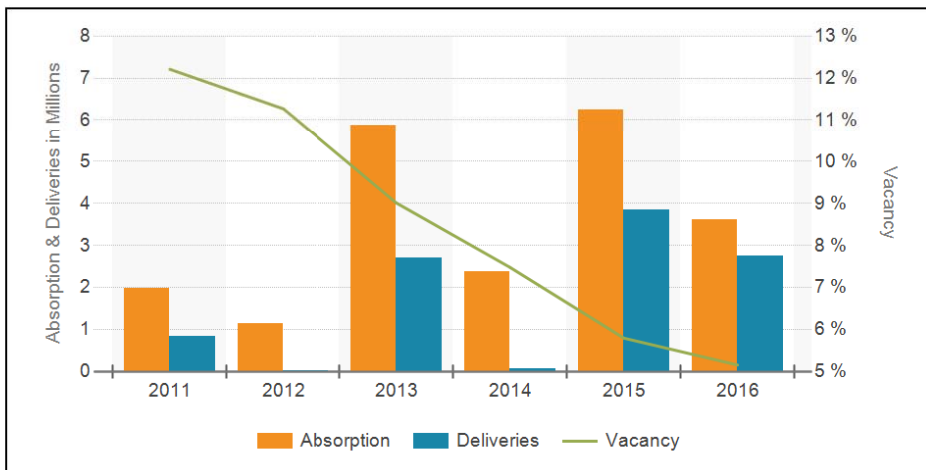


**Industrial Market Overview**

The industrial market in the primary market area has experienced significant growth since 2014. As shown in Figure 1 below, vacancies have continued to decline due to the positive absorption of leased industrial space. With limited deliveries in the recent years, the market appears poised to continue to absorb the approximately 8.7 million square feet of industrial space delivered in 2015 (down from 10.7 million square feet in 2014). The decreased vacancy rates have subsequently placed upward pressure on average asking rents, which have continued to increase from year to year. Current rental rates in the primary market area average \$4.14 annually per square foot (\$0.35 monthly) on a triple net (NNN) lease.

The market area continues to attract new development and has delivered over 6.5 million square feet of new industrial space in the last 18 months. Recent key transactions in 2016 include 1 million square feet leased to Amazon in Tracy, 745,000 square feet leased to UPS in Lathrop, and 250,000 square feet leased to Lifestyle Solutions in Stockton.

**Figure 1: Historical Absorption, Deliveries, and Vacancy for the Primary Market Area (2011-2016)**



Source: CoStar Property

Total square feet of industrial inventory in the primary market grew from approximately 155 million square feet in 2014 to approximately 162 million square feet in the second quarter of 2016. Deliveries in 2015 totaled approximately 3.8 million square feet with an additional estimated 3.3 million square feet delivered/under construction thus far in 2016. Additionally, the establishment of large-lot industrial subdivisions—with existing infrastructure—throughout the market area continue to market well to tenants looking to locate in the area.



Overall, the local industrial market has rebounded/grown consistently following the 2008 financial crisis; the trend is likely due to the increasing demand for e-commerce and large-scale logistics operations centers. CBRE—a commercial real estate firm—reports in Q2 2016 the user/type distribution of industrial real estate within the primary market area was 32% distribution/logistics, 29% e-commerce, 12% food and beverage processing, and 27% as other.<sup>2</sup> Table 1 details the historical market level statistics for the primary market area given the construction trends from 2007 to present.

**Table 1: Annual Industrial Market Statistics (2007-2016)**

Year	Inventory		Occupancy		Vacancy		Deliveries		Under Construction	
	Bldgs	SF	SF	Percent	SF	Percent	Bldgs	SF	Bldgs	SF
2016*	3,428	162,046,285	153,691,432	94.8%	7,991,954	5.2%	7	2,744,720	2	635,620
2015	3,418	159,237,565	150,008,589	94.2%	8,700,498	5.8%	9	3,850,673	7	2,744,720
2014	3,409	155,386,892	143,768,308	92.5%	10,782,623	7.5%	1	60,150	6	4,797,380
2013	3,410	155,388,236	141,386,749	91.0%	12,724,807	9.0%	5	2,706,220	2	999,150
2012	3,409	152,714,441	135,504,937	88.7%	15,312,058	11.3%	1	10,000	4	1,706,181
2011	3,413	153,056,444	134,363,696	87.8%	16,392,371	12.2%	2	843,000	0	0
2010	3,416	152,542,628	132,391,183	86.8%	17,475,636	13.2%	3	157,970	2	843,000
2009	3,414	152,429,358	132,296,036	86.8%	17,463,077	13.2%	40	2,598,573	3	157,970
2008	3,377	149,858,250	135,504,445	90.4%	13,008,427	9.6%	67	7,761,690	36	2,273,162
2007	3,311	142,104,251	126,731,059	89.2%	13,686,954	10.8%	90	2,247,415	35	4,609,611

Source: CoStar Property; AECOM, 2016  
\*Year to date

The primary market area consists of fourteen (14) submarkets which largely correlate with local population centers or transportation junctions. The CLIBP is located approximately six (6) miles south of the City of Patterson and will likely compete within the Patterson submarket on local level.

Table 2 details the total industrial market fundamentals for all submarkets in the primary market area. The Patterson industrial market has one of the lowest vacancies (2.5%) in the primary market area, only trailing behind Lodi (0.4%), Ripon (0.4%), Ceres (2.2%), and Turlock (2.4%). Consistent with these low vacancy levels, industrial space in Patterson has the second highest quoted annual rents (\$7.67) in the primary market area following only the Ripon submarket (\$8.40).

<sup>2</sup> CBRE Marketview, Central Valley Industrial, Q2, 2016



**Table 2: Total Industrial Submarket Statistics (Mid-Year 2016)**

Submarket	Existing Inventory		Vacancy			YTD Net	YTD	Under	Quoted <sup>1</sup>
	# Bldgs	Total RBA <sup>2</sup>	Direct SF	Total SF	Vac %	Absorption	Deliveries	Const SF	Rates
Ceres	184	5,298,908	114,916	114,916	2.2%	(22,274)	0	0	\$5.07
Lathrop	44	8,480,947	1,612,100	1,612,100	19.0%	1,500	749,100	0	\$3.16
Lodi	276	11,321,096	46,711	46,711	0.4%	24,073	0	0	\$6.37
Manteca	130	7,083,917	197,160	297,960	4.2%	132,406	0	0	\$5.55
Modesto	691	28,137,468	1,103,502	1,103,502	3.9%	270,119	0	476,580	\$4.29
NE Stockton	655	16,340,049	1,525,788	1,525,788	9.3%	137,652	0	0	\$3.80
Oakdale	76	2,447,480	82,335	82,335	3.4%	996	0	0	\$4.23
Patterson	41	5,968,887	146,555	146,555	2.5%	7,175	0	0	\$7.67
Ripon	29	911,103	4,000	4,000	0.4%	8,075	0	0	\$8.40
Riverbank	21	1,039,410	100,128	100,128	9.6%	0	0	0	\$2.26
SE Stockton	352	27,902,384	1,464,939	1,464,939	5.3%	284,992	0	0	\$4.24
Tracy	209	20,904,263	1,419,989	1,419,989	6.8%	1,425,209	1,000,000	467,000	\$4.79
Turlock	306	6,780,489	163,182	163,182	2.4%	30,368	22,040	38,000	\$4.18
West Stockton	141	11,192,449	172,694	292,694	2.6%	10,596	0	0	\$3.41
<b>Totals</b>	<b>3,155</b>	<b>153,808,850</b>	<b>8,153,999</b>	<b>8,374,799</b>	<b>5.4%</b>	<b>2,310,887</b>	<b>1,771,140</b>	<b>981,580</b>	<b>\$4.14</b>

Source: CoStar Property; AECOM, 2016

<sup>1</sup> Quoted as annual per SF rates (NNN)

<sup>2</sup> Rentable Building Area

Overall, Stanislaus County reports a notable lower vacancy (3.4%) than San Joaquin County (6.4%) with slightly higher rents. Table 3 details the industrial markets fundamentals for the two counties.

**Table 3: Total Industrial Market Statistics (Mid-Year 2016)**

Market	Existing Inventory		Vacancy			YTD Net	YTD	Under	Quoted <sup>1</sup>
	# Bldgs	Total RBA	Direct SF	Total SF	Vac %	Absorption	Deliveries	Const SF	Rates
San Joaquin County	1,836	104,136,208	6,443,381	6,664,181	6.4%	2,024,503	1,749,100	467,000	\$4.11
Stanislaus County	1,319	49,672,642	1,710,618	1,710,618	3.4%	286,384	22,040	514,580	\$4.21
<b>Totals</b>	<b>3,155</b>	<b>153,808,850</b>	<b>8,153,999</b>	<b>8,374,799</b>	<b>5.4%</b>	<b>2,310,887</b>	<b>1,771,140</b>	<b>981,580</b>	<b>\$4.14</b>

Source: CoStar Property; AECOM, 2016

<sup>1</sup> Quoted as annual per SF rates (NNN)



### Industrial Flex Space Overview

Industrial Flex space is limited in the overall market area with approximately 4.2 million square feet in rentable building area (RBA) and no reported new deliveries in the last eight years. Flex space throughout the market area reports significantly higher rents than traditional warehouse space which is common among broader California industrial markets. Table 4 details the market fundamentals for Flex industrial space throughout the primary market area.

**Table 4: Industrial Flex Submarket Statistics (Mid-Year 2016)**

Submarket	Existing Inventory		Vacancy			YTD Net Absorption	YTD Deliveries	Under Const SF	Quoted <sup>1</sup> Rates
	# Bldgs	Total RBA	Direct SF	Total SF	Vac %				
Ceres	3	24,000	0	0	0.0%	0	0	0	\$0.00
Lathrop	0	0	0	0	0.0%	0	0	0	\$0.00
Lodi	5	155,500	0	0	0.0%	0	0	0	\$15.00
Manteca	1	8,054	0	0	0.0%	0	0	0	\$0.00
Modesto	14	329,329	111,708	111,708	33.9%	10,250	0	0	\$10.89
NE Stockton	48	1,583,960	41,071	41,071	2.6%	4,618	0	0	\$6.62
Oakdale	6	26,935	0	0	0.0%	0	0	0	\$0.00
Patterson	1	23,875	0	0	0.0%	0	0	0	\$0.00
Ripon	1	8,000	0	0	0.0%	0	0	0	\$0.00
Riverbank	0	0	0	0	0.0%	0	0	0	\$0.00
SE Stockton	18	1,078,177	17,262	17,262	1.6%	0	0	0	\$9.00
Tracy	7	783,106	0	0	0.0%	0	0	0	\$0.00
Turlock	2	46,919	0	0	0.0%	0	0	0	\$0.00
West Stockton	2	201,193	1,554	1,554	0.8%	(539)	0	0	\$12.62
<b>Totals</b>	<b>108</b>	<b>4,269,048</b>	<b>171,595</b>	<b>171,595</b>	<b>4.0%</b>	<b>14,329</b>	<b>0</b>	<b>0</b>	<b>\$9.57</b>

Source: CoStar Property; AECOM, 2016

<sup>1</sup> Quoted as annual per SF rates (NNN)

As shown in Table 5 Stanislaus County has significantly higher vacancies in Flex space than San Joaquin County with slightly higher annual rents.

**Table 5: Flex Market Statistics (Mid-Year 2016)**

Market	Existing Inventory		Vacancy			YTD Net Absorption	YTD Deliveries	Under Const SF	Quoted <sup>1</sup> Rates
	# Bldgs	Total RBA	Direct SF	Total SF	Vac %				
San Joaquin County	82	3,817,990	59,887	59,887	1.6%	4,079	0	0	\$9.26
Stanislaus County	26	451,058	111,708	111,708	24.8%	10,250	0	0	\$10.89
<b>Totals</b>	<b>108</b>	<b>4,269,048</b>	<b>171,595</b>	<b>171,595</b>	<b>4.0%</b>	<b>14,329</b>	<b>0</b>	<b>0</b>	<b>\$9.57</b>

Source: CoStar Property; AECOM, 2016

<sup>1</sup> Quoted as annual per SF rates (NNN)



**Industrial Warehouse Space Overview**

Industrial warehouse space is the dominant product type within the Industrial category. Warehouse space includes logistics and distribution centers and general warehousing facilities (which include food and beverage, light manufacturing, etc). The primary market area has approximately 149.5 million square feet of RBA with an overall vacancy of 5.5%, with an average annual rent of \$4.11 per square foot, compared to the Patterson submarket which has approximately 5.9 million square feet of RBA with an overall vacancy of 2.5%, and an average annual rent of \$7.67 per square foot. Table 6 details the warehouse market statistics for the various submarkets within the market area.

**Table 6: Warehouse Submarket Statistics (Mid-Year 2016)**

Submarket	Existing Inventory		Vacancy			YTD Net	YTD	Under	Quoted <sup>1</sup>
	# Bldgs	Total RBA	Direct SF	Total SF	Vac %	Absorption	Deliveries	Const SF	Rates
Ceres	181	5,274,908	114,916	114,916	2.2%	(22,274)	0	0	\$5.07
Lathrop	44	8,480,947	1,612,100	1,612,100	19.0%	1,500	749,100	0	\$3.16
Lodi	271	11,165,596	46,711	46,711	0.4%	24,073	0	0	\$5.97
Manteca	129	7,075,863	197,160	297,960	4.2%	132,406	0	0	\$5.55
Modesto	677	27,808,139	991,794	991,794	3.6%	259,869	0	476,580	\$4.25
NE Stockton	607	14,756,089	1,484,717	1,484,717	10.1%	133,034	0	0	\$3.78
Oakdale	70	2,420,545	82,335	82,335	3.4%	996	0	0	\$4.23
Patterson	40	5,945,012	146,555	146,555	2.5%	7,175	0	0	\$7.67
Ripon	28	903,103	4,000	4,000	0.4%	8,075	0	0	\$8.40
Riverbank	21	1,039,410	100,128	100,128	9.6%	0	0	0	\$2.26
SE Stockton	334	26,824,207	1,447,677	1,447,677	5.4%	284,992	0	0	\$4.22
Tracy	202	20,121,157	1,419,989	1,419,989	7.1%	1,425,209	1,000,000	467,000	\$4.79
Turlock	304	6,733,570	163,182	163,182	2.4%	30,368	22,040	38,000	\$4.18
West Stockton	139	10,991,256	171,140	291,140	2.6%	11,135	0	0	\$3.40
<b>Totals</b>	<b>3,047</b>	<b>149,539,802</b>	<b>7,982,404</b>	<b>8,203,204</b>	<b>5.5%</b>	<b>2,296,558</b>	<b>1,771,140</b>	<b>981,580</b>	<b>\$4.11</b>

Source: CoStar Property; AECOM, 2016

<sup>1</sup> Quoted as annual per SF rates (NNN)

As shown in Table 7 Stanislaus County has approximately one half of the RBA for warehouse space than San Joaquin County. Vacancies are lower and rents are slightly higher in the Stanislaus County area compared to San Joaquin County.

**Table 7: Warehouse Market Statistics (Mid-Year 2016)**

Market	Existing Inventory		Vacancy			YTD Net	YTD	Under	Quoted <sup>1</sup>
	# Bldgs	Total RBA	Direct SF	Total SF	Vac %	Absorption	Deliveries	Const SF	Rates
San Joaquin County	1,754	100,318,218	6,383,494	6,604,294	6.6%	2,020,424	1,749,100	467,000	\$4.09
Stanislaus County	1,293	49,221,584	1,598,910	1,598,910	3.2%	276,134	22,040	514,580	\$4.19
<b>Totals</b>	<b>3,047</b>	<b>149,539,802</b>	<b>7,982,404</b>	<b>8,203,204</b>	<b>5.5%</b>	<b>2,296,558</b>	<b>1,771,140</b>	<b>981,580</b>	<b>\$4.11</b>

Source: CoStar Property; AECOM, 2016

<sup>1</sup> Quoted as annual per SF rates (NNN)

**Summary**

Overall the demand for industrial space within Stanislaus County and San Joaquin County continues to increase, creating a predominantly positive absorption trend since 2010. Since AECOM's prior assessment of the market area in 2014, the realized demand consistently absorbed new development as well as existing vacant space, pushing vacancies lower. As a result, pressure from increased demand has continued to drive up average annual rents.

The Patterson area continues to be a top performer in the market area compared to other peer submarkets. In 2014 AECOM reported the Patterson area to have a total of 4.2 million square feet of industrial RBA with a vacancy of 7.8% and estimated average annual rents of \$4.77. In the second quarter of 2016 the Patterson submarket reports approximately 5.9 million square feet of industrial RBA with a vacancy of 2.5% and average annual rents reaching \$7.67. The decrease in vacancy and associated increase in rents is likely influenced by the general economic recovery, the growth within the e-commerce and logistics/distribution industries, as well as an increased demand for modern facilities within the local area.

**General and Limiting Conditions**

AECOM devoted effort consistent with (i) the level of diligence ordinarily exercised by competent professionals practicing in the area under the same or similar circumstances, and (ii) the time and budget available for its work to ensure that the data contained in this report is accurate as of the date of its preparation. This study is based on estimates, assumptions, and other information developed by AECOM from its independent research effort, general knowledge of the industry, and information provided by and consultations with the Client and the Client's representatives. No responsibility is assumed for inaccuracies in reporting by the Client, the Client's agents and representatives, or any third-party data source used in preparing or presenting this study. AECOM assumes no duty to update the information contained herein unless it is separately retained to do so pursuant to a written agreement signed by AECOM and the Client.

AECOM's findings represent its professional judgment. Neither AECOM nor its parent corporation, nor their respective affiliates, makes any warranty, expressed or implied, with respect to any information or methods disclosed in this document. Any recipient of this document other than the Client, by their acceptance or use of this document, releases AECOM, its parent corporation, and their affiliates from any liability for direct, indirect, consequential, or special loss or damage, whether arising in contract, warranty (express or implied), tort, or otherwise, and irrespective of fault, negligence, and strict liability.

This report may not to be used in conjunction with any public or private offering of securities, debt, equity, or other similar purpose where it may be relied upon to any degree by any person other than the Client. This study may not be used for purposes other than those for which it was prepared or for which prior written consent has been obtained from AECOM.



Possession of this study does not carry with it the right of publication or the right to use the name of “AECOM” in any manner without the prior written consent of AECOM. No party may abstract, excerpt, or summarize this report without the prior written consent of AECOM. AECOM has served solely in the capacity of consultant and has not rendered any expert opinions in connection with the subject matter hereof. Any changes made to the study, or any use of the study not specifically identified in the agreement between the Client and AECOM or otherwise expressly approved in writing by AECOM, shall be at the sole risk of the party making such changes or adopting such use.

This document was prepared solely for the use by the Client. No party may rely on this report except the Client or a party so authorized by AECOM in writing (including, without limitation, in the form of a reliance letter). Any party who is entitled to rely on this document may do so only on the document in its entirety and not on any excerpt or summary. Entitlement to rely upon this document is conditioned upon the entitled party accepting full responsibility and not holding AECOM liable in any way for any impacts on the forecasts or the earnings from the project resulting from changes in “external” factors such as changes in government policy, pricing of commodities and materials, price levels generally, competitive alternatives to the project, the behavior of consumers or competitors, and changes in the owners’ policies affecting the operation of their projects.

This document may include “forward-looking statements.” These statements relate to AECOM’s expectations, beliefs, intentions, or strategies regarding the future. These statements may be identified by the use of words like “anticipate,” “believe,” “estimate,” “expect,” “intend,” “may,” “plan,” “project,” “will,” “should,” “seek,” and similar expressions. The forward-looking statements reflect AECOM’s views and assumptions with respect to future events as of the date of this study, and are subject to future economic conditions and other risks and uncertainties. Actual and future results and trends could differ materially from those set forth in such statements due to various factors, including, without limitation, those discussed in this study. These factors are beyond AECOM’s ability to control or predict. Accordingly, AECOM makes no warranty or representation that any of the projected values or results contained in this study will actually be achieved.

This study is qualified in its entirety by, and should be considered in light of, these limitations, conditions, and considerations.



## **Appendix L – Mitigation Monitoring and Reporting Program**

Draft Mitigation Measures are listed in the Executive Summary of the Draft Environmental Impact Report (EIR) for the Crows Landing Industrial Business Park Specific Plan. The Mitigation Monitoring and Reporting Program (MMRP) will be appended to both the Final EIR and Specific Plan, once the EIR is certified by Stanislaus County.

## **MITIGATION MONITORING AND REPORTING PROGRAM**

### **CALIFORNIA ENVIRONMENTAL QUALITY ACT REQUIREMENT**

Where a California Environmental Quality Act (CEQA) document has identified significant environmental effects, Public Resources Code Section 21081.6 requires adoption of a “reporting or monitoring program for the changes to the project which it has adopted or made a condition of a project approval to mitigate or avoid significant effects on the environment.”

This Environmental Mitigation Monitoring and Reporting Program (MMRP) has been prepared to provide for the monitoring of mitigation measures required of the Crows Landing Industrial Business Park Specific Plan (proposed project or “CLIBP”), as set forth in the Final Environmental Impact Report (EIR). The County of Stanislaus is the Lead Agency that must adopt the MMRP for development and operation of the project.

The CEQA Statutes and Guidelines provide direction for clarifying and managing the complex relationships between a lead agency and other agencies with implementing and monitoring mitigation measures. In accordance with CEQA Guidelines Section 15097(d), “each agency has the discretion to choose its own approach to monitoring or reporting; and each agency has its own special expertise.” This discretion will be exercised by implementing agencies at the time they undertake any of portion of the project, as identified in the EIR.

### **PURPOSE OF MITIGATION MONITORING AND REPORTING PROGRAM**

The intent of the MMRP is to ensure the effective implementation and enforcement of adopted mitigation measures. The MMRP is intended to be used by County staff and others responsible for project implementation.

This document identifies the individual mitigation measures, the party responsible for monitoring implementation of the measure, the timing of implementation, and space to confirm implementation of the mitigation measures.

### **ROLES AND RESPONSIBILITIES**

Stanislaus County will oversee monitoring and documenting the implementation of mitigation measures. The County or its construction contractor is responsible for fully understanding and effectively implementing all of the mitigation measures contained within this MMRP. Certain mitigation measures also will require that future project applicants coordinate or consult with one or more other public agencies in implementing mitigation measures specified herein.

### **CHANGES TO MITIGATION MEASURES**

Any substantive change in the MMRP is required to be reported in writing. Modifications to the mitigation measures may be made by Stanislaus County, subject to one of the following findings, and documented by evidence included in the public record:

- ▶ The mitigation measure included in the Final EIR and the MMRP is no longer required because the significant environmental impact identified in the Final EIR has been found not to exist, or to occur at a level

which makes the impact less than significant as a result of changes in the project, changes in environment conditions, or other factors.

OR,

- ▶ The modified or substitute mitigation measure provides a level of environmental protection equal to, or greater than that afforded by the mitigation measure included in the Final EIR and the MMRP; and,
- ▶ The modified or substitute mitigation measure or measures do not have significant adverse effects on the environment in addition to, or greater than those which were considered by the responsible hearing parties in their decisions on the Final EIR and the proposed project; and,
- ▶ The modified or substitute mitigation measures are feasible, and the County, through measures included in the MMRP or other County procedures, can ensure implementation.

## **SUPPORT DOCUMENTATION**

Findings and related documentation supporting the findings involving modifications to mitigation measures shall be maintained in the project file with this MMRP and shall be made available to the public upon request.

This MMRP will be kept on file at:

Stanislaus County Planning and Community Development Department  
1010 10th Street, Suite 3400  
Modesto, CA 95354

Impact	Mitigation Measure	Implementation	Timing	Enforcement
<b>3.2 Air Quality</b>				
3.2-1 Generation of short-term construction and long-term operational emissions.	<p><b>Construction Emissions</b></p> <p><b>3.2-1a: Comply with Current ISR.</b></p> <p>As applicable, based on the project size thresholds specified in Rule 9510 (Indirect Source Review), projects within the Specific Plan Area shall comply with SJVAPCD’s Rule 9510 Indirect Source Review (ISR) and reduce criteria air pollutant emissions consistent with SJVAPCD performance standards through feasible on-site strategies and, if necessary, feasible payment of off-site mitigation fees to SJVAPCD through a voluntary emission reduction agreement (VERA) or other appropriate mechanism.</p>	Leaseholders / developers / contractors.	Demonstrate compliance prior to issuance of building permit.	SJVAPCD.
	<p><b>Operational Emissions</b></p> <p><b>3.2-1b: Use Current Phase Equipment for All Construction Equipment.</b></p> <p>Site developers/leaseholders/project applicants who wish to develop facilities in the Specific Plan Area shall provide for County review and approval a proposed inventory of equipment for development within the Specific Plan Area that demonstrates use of current phase construction equipment (currently Tier 4).</p>	Leaseholders / developers / contractors.	Demonstrate compliance prior to issuance of building permit.	Stanislaus County.
	<p><b>3.2-1c: Reduce the Single Occupant Vehicle Commute.</b></p> <p>Policy Six of the Stanislaus County General Plan reads “The County shall strive to reduce motor vehicle emissions and vehicle trips by encouraging the use of alternatives to the single occupant vehicle.” The project shall implement Policy Six through the incorporation of the following strategies or alternative strategies determined to be equally or more effective in reducing the rate of single-occupant vehicle commutes to the project site at buildout:</p> <ul style="list-style-type: none"> <li>▶ Prior to the occupancy of the first building within the Crows Landing Industrial Business Park, a TDM or</li> </ul>	Leaseholders / developers / contractors and Stanislaus County.	<p>Upon operation of employment-generating uses for on-demand transit.</p> <p>Upon completion of Phase 2 for fixed transit service.</p>	Stanislaus County.

Impact	Mitigation Measure	Implementation	Timing	Enforcement
	<p>similar program shall be established or an existing program, such as the Commute Connection program, shall be designated to represent the project. The program will provide a comprehensive strategy to reduce solo occupant vehicle travel by employees, business vehicles including trucks, and visitors. The program shall identify TDM goals for CLIBP, including goals to reduce daily travel and travel during morning and afternoon peak-demand periods. The overall operational air pollutant emissions mitigation performance standard is established by the San Joaquin Valley Air Pollution Control District through Rule 9510, the Indirect Source Rule, requiring applicable projects to achieve a minimum reduction of 33.3 percent of operational baseline NO<sub>x</sub> emissions over a period of 10 years and a minimum reduction of 50 percent of operational PM<sub>10</sub> emissions over a period of 10 years. TDM goals for CLIBP shall be established, monitored, and adjusted, if necessary, to contribute to this overall operational air pollutant emissions mitigation performance standard.</p> <ul style="list-style-type: none"> <li>▶ The CLIBP TDM program shall require mandatory annual employee surveys with a response rate of at least 90 percent. The surveys will include, as a minimum, mode and time of travel by employees. The CLIBP TDM program shall prepare an annual report indicating status of compliance with the TDM goals established by the County.</li> <li>▶ The individual companies and the CLIBP TDM program shall consider the following items or other measures to reduce travel demand and achieve TDM goals: <ul style="list-style-type: none"> <li>• Encourage employers to use flex-time</li> <li>• Carpool matching programs</li> <li>• Preferred parking for carpoolers</li> <li>• Van pool programs</li> <li>• On-site facilities such as break rooms and shower facilities</li> <li>• Establishment of employer sponsored shuttles from Turlock and Modesto</li> <li>• On-site secure bicycle racks</li> </ul> </li> </ul>			

Impact	Mitigation Measure	Implementation	Timing	Enforcement
	<ul style="list-style-type: none"> <li>• Bike share programs for employee usage at lunchtime</li> <li>• Other measures</li> </ul> <p>▶ All employers operating within the Specific Plan Area shall participate in the TDM or Commute Connection program or future program providing the same services to allow employees to conveniently identify non-single occupancy vehicle methods to reach the proposed project site. Employers should not be considered as separate entities, but rather the entire site shall be considered collectively as a participating entity. The requirement to participate in the Commute Connection program shall be included in leases for Specific Plan developments. A person(s) shall be assigned to represent CLIBP on an ongoing basis to coordinate with individual businesses.</p> <p>▶ New development projects that anticipate 100 or more full-time equivalent employees shall coordinate participation in the Commute Connection program or similar future program to reduce employee commute trips and to promote transportation other than the single passenger motor vehicle, including, but not limited to carpools, vanpools, buspools, public transit, and bicycling. The employee commute trip reduction program should include incentives, services, and policies. This program shall include preferential parking in relatively more convenient locations for electric vehicles, carpools, vanpools and other vehicles carrying commuter passengers on a regular basis.</p> <p>▶ The County shall identify and accommodate at least one transit stop or commuter shuttle to serve the project site that would provide feasible commuter service for project employees.</p>			
	<p><b>Mitigation Measure 3.2-1d: Provide Transit to the Workplace.</b></p> <p>▶ The County shall ensure that the placement and design of transit stops can accommodate public transit for employees and patrons. The County shall identify locations to expand services, including park and ride lots, to enable and encourage the use of transit to the workplace within the Crows Landing Specific Plan Area.</p>	Stanislaus County.	<p>Upon operation of employment-generating uses for on-demand transit.</p> <p>Upon completion of Phase 2 for fixed transit service.</p>	Stanislaus County.

Impact	Mitigation Measure	Implementation	Timing	Enforcement
	<p>The placement and design of transit stops within the Specific Plan Area shall be approved by the Stanislaus County Public Works Department based on generally accepted transit planning principles.</p> <ul style="list-style-type: none"> <li>▶ The County shall ensure on-demand transit service to the Specific Plan Area once employment generating uses are established within the Specific Plan Area and fixed transit service upon completion of Phase 2.</li> <li>▶ The overall operational air pollutant emissions mitigation performance standard is established by the San Joaquin Valley Air Pollution Control District through Rule 9510, the Indirect Source Rule, requiring applicable projects to achieve a minimum reduction of 33.3 percent of operational baseline NOX emissions over a period of 10 years and a minimum reduction of 50 percent of operational PM10 emissions over a period of 10 years. Transit to the Specific Plan Area shall be established, monitored, and adjusted, if necessary, to contribute to this overall operational air pollutant emissions mitigation performance standard.</li> </ul>			
<p>3.2-3 Exposure of sensitive receptors to emissions of toxic air contaminants.</p>	<p><b>Operational Emissions</b></p> <p><b>3.2-3b: Assess TAC Emissions and Health Risks Associated with Operations.</b></p> <p>Projects proposed within 1,000 feet of an existing daycare or an off-site residence shall be required to analyze and report on potential health risk impacts of PM2.5 and TAC concentrations from long-term operations in accordance with SJVAPCD-recommended methods prior to the issuance of a building permit for new construction, tenant improvement, or change of use. Factors that would affect the need for health risk analysis include, but are not limited to the proposed land use; types, intensity, and frequency of TAC emissions generated by operational activities; and other project parameters, such as heavy-duty truck traffic, number of loading docks, and manufacturing throughput. If health risk impacts are determined to exceed SJVAPCD thresholds of significance under any potential operational</p>	<p>Leaseholders / developers / contractors.</p>	<p>Prior to issuance of building permit, tenant improvement, or change in use.</p>	<p>Stanislaus County.</p>

Impact	Mitigation Measure	Implementation	Timing	Enforcement
	<p>exposure scenario, projects shall implement Mitigation Measure 3.2-3c. The requirement to conduct health risk analysis may be waived if determined by the County's Planning Director that the proposed use has already been assessed and shown to have no health risk impacts necessitating a project-specific health risk analysis or if the SJVAPCD determines that there is no further need for health risk analysis.</p>			
	<p><b>3.2-3c: Reduce Exposure to Substantial Pollutant Concentrations from Operations.</b></p> <p>If it is determined that a proposed use could potentially generate health risk impacts that exceed SJVAPCD thresholds of significance, the proposed project shall identify and implement strategies to reduce impacts below applicable SJVAPCD thresholds of significance.</p> <p>A range of potential strategies is available to avoid exposure to substantial pollutant concentrations for sensitive receptors (daycare) and to avoid significant impacts. However, new technologies or methods for avoiding exposure to pollutant concentrations may emerge or become feasible in the future, and those technologies and methods would be implemented in addition to or instead of those identified in the EIR to reduce any potential health risk impacts below applicable SJVAPCD thresholds of significance.</p> <p>Strategies could include, but are not limited to placement of on-site daycare uses at a sufficient distance to avoid impacts associated with potential sources of TAC emissions, such as manufacturing facilities, loading docks, and distribution centers. Building space to be used for daycare could incorporate High Efficiency Particle Arresting (HEPA) filter systems at mechanical air intake points to the building to reduce the levels of PM that enter buildings and/or orient air intake away from areas generating emissions. Uses that generate TAC emissions could also use orientation away from sensitive receptors or controls on emissions concentrations. Commercial and industrial land uses that would host diesel trucks could incorporate technologies such as IdleAire, electrification of truck parking, and/or</p>	<p>Leaseholders / developers / contractors.</p>	<p>Identify strategies to reduce pollutant concentrations prior to issuance of building permit, tenant improvement, or change in use and implement strategies during operations.</p>	<p>Stanislaus County.</p>



Impact	Mitigation Measure	Implementation	Timing	Enforcement
	alternative energy sources for TRUs to allow diesel engines to reduce or avoid idling.			
<b>3.4 Biological Resources</b>				
3.4-1 Loss of special-status plants	<p><b>3.4-1: Conduct Special-status Plant Surveys; Implement Compensatory Mitigation for Special-status Plants.</b></p> <p>The following measures shall be implemented:</p> <ul style="list-style-type: none"> <li>▶ Retain a qualified botanist to conduct protocol-level preconstruction special-status plant surveys for potentially occurring species for each phase of construction. All plant species encountered on the project site shall be identified to the taxonomic level necessary to determine species status. The surveys shall be conducted no more than 5 years prior and no later than the blooming period immediately preceding the approval of a grading or improvement plan or any ground disturbing activities, including grubbing or clearing.</li> <li>▶ Notify CDFW, as required by the California Native Plant Protection Act, if any special-status plants are found on the project site. Notify the USFWS if any plant species listed under the Endangered Species Act are found.</li> <li>▶ Develop a mitigation and monitoring plan to compensate for the loss of any special-status plant species found during preconstruction surveys. The mitigation and monitoring plan shall be submitted to CDFW or USFWS, as appropriate depending on species status, for review and approval. The County shall consult with these entities, as appropriate depending on species status, before approval of the plan to determine the appropriate mitigation measures for impacts on any special-status plant population. On-site mitigation measures may include the creation of off-site populations on project mitigation sites through seed collection or transplantation, and/or restoring or creating occupied habitat in sufficient quantities to achieve no net loss of occupied habitat or individuals. Mitigation could also include purchase of an existing off-site area in Stanislaus County that is known to support the special-status species to be affected, as well as preserving the site in perpetuity. The preservation and</li> </ul>	Leaseholders / developers / contractors.	Before any ground disturbing activities, including grubbing or clearing.	Stanislaus County, USFWS, and CDFW, as appropriate, depending on species status.

Impact	Mitigation Measure	Implementation	Timing	Enforcement
	<p>enhancing of existing on-site populations shall not be considered as mitigation.</p> <p>▶ If transplantation is a proven method for a species (i.e., information exists demonstrating that the affected species has been successfully transplanted or established from seed using a methodology that can be repeated) and relocation efforts are part of the mitigation plan approved by the County and CDFW or USFWS, as appropriate depending on species status,, the plan shall include a description and map of mitigation sites, details on the methods to be used, including collection, storage, propagation, receptor site preparation, installation, long-term protection and management, monitoring and reporting requirements, remedial action responsibilities should the initial effort fail to meet long-term monitoring requirements, and sources of funding to purchase, manage, and preserve the sites. The following performance standards shall be applied:</p> <ul style="list-style-type: none"> <li>• The extent of occupied area and the flower density in compensatory reestablished populations shall be equal to or greater than the affected occupied habitat and shall be self-producing.</li> <li>• Reestablished populations shall be considered self-producing when:</li> <li>• plants re-establish annually for a minimum of 5 years with no human intervention, such as supplemental seeding; and</li> <li>• re-established habitats contain an occupied area and flower density comparable to existing occupied habitat areas in similar habitat types.</li> </ul> <p>▶ If off-site mitigation includes dedication of conservation easements, purchase of mitigation credits, or other off-site conservation measures, the details of these measures shall be included in the mitigation plan, including information on responsible parties for long-term management, conservation easement holders, long-term management requirements, and other details, as appropriate to target the preservation of long term viable populations.</p>			

Impact	Mitigation Measure	Implementation	Timing	Enforcement
3.4-2 Special-status raptors and other nesting raptors.	<p><b>3.4-2a: Avoid Direct Loss of Swainson’s Hawk and Other Raptors</b></p> <p>The following measures shall be implemented:</p> <ul style="list-style-type: none"> <li>▶ Tree and vegetation removal shall be completed during the nonbreeding season for raptors (September 1–February 28).</li> <li>▶ To avoid, minimize, and mitigate potential impacts on Swainson’s hawk and other raptors (not including burrowing owl) nesting on or adjacent to the project site and off-site improvement areas, retain a qualified biologist to conduct preconstruction surveys and identify active nests on and within 0.5 mile of the project site and off-site improvement areas for construction activities conducted during the breeding season (March 1–August 31). The surveys shall be conducted before the approval of grading and/or improvement plans (as applicable) and no less than 14 days and no more than 30 days before the beginning of construction. Guidelines provided in <i>Recommended Timing and Methodology for Swainson’s Hawk Nesting Surveys in the Central Valley</i> (Swainson’s Hawk Technical Advisory Committee 2000) or updated, current guidance shall be followed for surveys for Swainson’s hawk. If no nests are found, no further mitigation will be required.</li> <li>▶ Impacts on nesting Swainson’s hawks and other raptors shall be avoided by establishing appropriate buffers around active nest sites identified during preconstruction raptor surveys. No project activity shall commence within the buffer areas until a qualified biologist has determined, in coordination with CDFW, the young have fledged, the nest is no longer active, or reducing the buffer would not result in nest abandonment. CDFW guidelines recommend implementation of 0.25- or 0.5-mile-wide buffers for Swainson’s hawk nests, but the size of the buffer may be decreased if a qualified biologist and the County, in consultation with CDFW, determine that such an adjustment would not be likely to adversely affect the nest.</li> </ul>	Leaseholders / developers / contractors.	Before any vegetation removal, grading, and on an ongoing basis throughout construction, as applicable.	Stanislaus County and CDFW.

Impact	Mitigation Measure	Implementation	Timing	Enforcement
	<ul style="list-style-type: none"> <li>▶ The appropriate no-disturbance buffer for other raptor nests (<i>i.e.</i>, species other than Swainson’s hawk) shall be determined by a qualified biologist based on site-specific conditions, the species of nesting bird, nature of the project activity, visibility of the disturbance from the nest site, and other relevant circumstances.</li> <li>▶ Monitoring of all active raptor nests by a qualified biologist during construction activities will be required if the activity has potential to adversely affect the nest. If construction activities cause the nesting bird to vocalize, make defensive flights at intruders, get up from a brooding position, or fly off the nest, then the no-disturbance buffer shall be increased until the agitated behavior ceases. The exclusionary buffer will remain in place until the chicks have fledged or as otherwise determined appropriate by a qualified biologist.</li> </ul>			
	<p><b>3.4-2b: Avoid Loss of Burrowing Owl</b></p> <p>The following measures shall be implemented:</p> <ul style="list-style-type: none"> <li>▶ To avoid, minimize, and mitigate potential impacts on burrowing owl, a qualified biologist shall be retained to conduct focused breeding and nonbreeding season surveys for burrowing owls in areas of suitable habitat on and within 1,500 feet of the project site and off-site improvement areas. Surveys will be conducted prior to the start of construction activities for each project phase and in accordance with Appendix D of CDFW’s Staff Report on Burrowing Owl Mitigation (2012) or updated, current guidance.</li> <li>▶ If no occupied burrows are found, a letter report documenting the survey methods and results will be submitted to the County and CDFW and no further mitigation will be required.</li> <li>▶ If an active burrow is found during the nonbreeding season (September 1 through January 31), owls will be relocated outside of the Specific Plan Area using passive or active methodologies developed in consultation with CDFW and may include active relocation to preserve areas if approved by CDFW and the preserve managers.</li> </ul>	Leaseholders / developers / contractors.	Before any vegetation removal, grading, and on an ongoing basis throughout construction, as applicable.	Stanislaus County and CDFW.

Impact	Mitigation Measure	Implementation	Timing	Enforcement
	<p>No burrowing owls will be excluded from occupied burrows until a burrowing owl exclusion and relocation plan is developed by the project applicant and approved by CDFW.</p> <ul style="list-style-type: none"> <li>▶ If an active burrow is found during the breeding season (February 1 through August 31), occupied burrows will not be disturbed and will be provided with a 150- to 1,500-foot protective buffer unless a qualified biologist verifies through noninvasive means that either: (1) the birds have not begun egg laying, or (2) juveniles from the occupied burrows are foraging independently and are capable of independent survival. The size of the buffer will depend on the time of year and level of disturbance, as outlined in the CDFW Staff Report (2012, pg. 9). Once the fledglings are capable of independent survival, the owls will be relocated outside the Airport Influence Area in accordance with a burrowing owl exclusion and relocation plan developed in consultation with CDFW and the burrow will be destroyed to prevent owls from reoccupying it. No burrowing owls will be excluded from occupied burrows until a burrowing owl exclusion and relocation plan is approved by CDFW. Following owl exclusion and burrow demolition, the site shall be monitored by a qualified biologist to ensure burrowing owls do not recolonize the site prior to construction.</li> <li>▶ If active burrowing owl nests are found on the project site or off-site improvement areas and these nest sites are lost as a result of implementing the project, the loss shall be mitigated through preservation of other known nest sites in Stanislaus County, at a minimum ratio of 1:1. A mitigation and monitoring plan shall be developed for the compensatory mitigation areas.</li> <li>▶ The mitigation and monitoring plan will include detailed information on the habitats present within the preservation areas, the long-term management and monitoring of these habitats, legal protection for the preservation areas (<i>e.g.</i>, conservation easement, declaration of restrictions), and funding mechanism information (<i>e.g.</i>, endowment). All burrowing owl mitigation lands shall be preserved in perpetuity and</li> </ul>			

Impact	Mitigation Measure	Implementation	Timing	Enforcement
	<p>incompatible land uses shall be prohibited in habitat conservation areas.</p> <ul style="list-style-type: none"> <li>▶ Burrowing owl mitigation land shall be transferred through either conservation easement or fee title, to a third-party, nonprofit conservation organization (Conservation Operator), with the CDFW named as third-party beneficiaries. The Conservation Operator shall be a qualified conservation easement land manager that manages land as its primary function. Additionally, the Conservation Operator shall be a tax-exempt nonprofit conservation organization that meets the criteria of Civil Code Section 815.3(a). CDFW and the Conservation Operator shall each have the power to enforce the terms of the conservation easement. The Conservation Operator shall monitor the easement in perpetuity to ensure compliance with the terms of the easement.</li> </ul>			
	<p><b>3.4-2c: Prepare and Implement a Swainson's Hawk Foraging Habitat Mitigation Plan</b></p> <p>The following measures shall be implemented:</p> <ul style="list-style-type: none"> <li>▶ Before any ground-disturbing activities, suitable Swainson's hawk foraging habitat shall be preserved to ensure replacement of foraging habitat lost as a result of the project, as determined by a qualified biologist, in consultation with CDFW.</li> <li>▶ The habitat value shall be based on Swainson's hawk nesting distribution and an assessment of habitat quality, availability, and use within the County. The mitigation ratio shall be consistent with the 1994 DFG Swainson's Hawk Guidelines included in the <i>Staff Report Regarding Mitigation for Impacts to Swainson's Hawks (Buteo swainsoni) in the Central Valley of California</i>. These guidelines specify that the mitigation ratio shall be 1:1 if there is an active nest within 1 mile of the project site, 0.75:1 if there is an active nest within 5 miles but greater than 1 mile away, and 0.5:1 if there is an active nest within 10 miles but greater than 5 miles away. If there is an active nest within 1 mile of the project site, the mitigation ratio can be reduced to 0.5:1 if all of the</li> </ul>	Leaseholders / developers / contractors.	Before any vegetation removal, grading, and on an ongoing basis throughout construction, as applicable.	Stanislaus County and CDFW.

Impact	Mitigation Measure	Implementation	Timing	Enforcement
	<p>mitigation land can be actively managed for prey production. Such mitigation shall be accomplished through either the transfer of fee title or perpetual conservation easement. The mitigation land shall be located within the known foraging area within Stanislaus County.</p> <ul style="list-style-type: none"> <li>▶ Before acceptance of such proposed mitigation, the County shall consult with CDFW regarding the appropriateness of the mitigation. If mitigation is accomplished through a conservation easement, then such an easement shall ensure the continued management of the land to maintain Swainson’s hawk foraging values, including but not limited to, ongoing agricultural uses and the maintenance of all existing water rights associated with the land. The conservation easement shall be recordable and shall prohibit any activity that substantially impairs or diminishes the land’s capacity as suitable Swainson’s hawk foraging habitat. The conservation easement should not be located within 5 miles of the proposed on-site airport.</li> <li>▶ Swainson’s hawk mitigation land shall be transferred, through either conservation easement or fee title, to a third-party, nonprofit conservation organization (Conservation Operator), with the CDFW named as third-party beneficiaries. The Conservation Operator shall be a qualified conservation easement land manager that manages land as its primary function. Additionally, the Conservation Operator shall be a tax-exempt nonprofit conservation organization that meets the criteria of Civil Code Section 815.3(a). CDFW and the Conservation Operator shall approve the content and form of the conservation easement. CDFW and the Conservation Operator shall each have the power to enforce the terms of the conservation easement. The Conservation Operator shall monitor the easement in perpetuity to assure compliance with the terms of the easement.</li> </ul>			

Impact	Mitigation Measure	Implementation	Timing	Enforcement
<p>3.4-3 Disturbance of tricolored blackbird, loggerhead shrike, and common nesting birds.</p>	<p><b>3.4-3: Avoid Direct Loss of Tricolored Blackbird and Loggerhead Shrike and Protected Bird Nests</b></p> <p>The following measures shall be implemented:</p> <ul style="list-style-type: none"> <li>▶ To the extent feasible, vegetation removal, grading, and other ground disturbing activities will be carried out during the nonbreeding season for protected bird species in this region (generally September 1–January 31).</li> <li>▶ For any project activity that would occur during the nesting season (February 1–August 31), the project applicant shall conduct a preconstruction survey. The preconstruction survey shall be conducted by a qualified biologist before any activity occurring within 300 feet of suitable nesting habitat for any protected bird species. The survey shall be conducted within 14 days before project activity begins.</li> <li>▶ If an active nest of loggerhead shrike, tricolored blackbird, or common bird species protected by the Migratory Bird Treaty Act or California Fish and Game Code is found, the qualified biologist shall establish a buffer around the nest. No construction activity shall commence within the buffer area until a qualified biologist confirms that the nest is no longer active. The appropriate no-disturbance buffer shall be based on site-specific conditions, the species of bird, nature of the project activity, the extent of existing disturbance in the area, and other relevant circumstances, as determined by a qualified biologist in consultation with CDFW.</li> <li>▶ Monitoring of all protected nests by a qualified biologist during construction activities will be required if the activity has potential to adversely affect the nest. If construction activities cause the nesting bird to vocalize, make defensive flights at intruders, get up from a brooding position, or fly off the nest, then the no-disturbance buffer shall be increased until the agitated behavior ceases. The exclusionary buffer will remain in place until the chicks have fledged or as otherwise determined by a qualified biologist.</li> </ul>	<p>Leaseholders / developers / contractors.</p>	<p>Before approval of any ground-disturbing activity within 300 feet of suitable nesting habitat, as applicable.</p>	<p>Stanislaus County and CDFW.</p>



Impact	Mitigation Measure	Implementation	Timing	Enforcement
3.4-4 Pallid bat.	<p><b>3.4-4: Avoid, Minimize, and Mitigate Loss of Bat Roosts.</b></p> <p>The following measures shall be implemented:</p> <ul style="list-style-type: none"> <li>▶ Before rehabilitation of the former air traffic control tower, or any work on the East Las Palmas Avenue bridge over the San Joaquin River, the County shall have a qualified biologist conduct focused surveys for roosting bats in said structure. Surveys shall be conducted in the fall to determine if structures are used as hibernacula and in spring and/or summer to determine if they are used as maternity or day roosts. Surveys shall consist of evening emergence surveys to note the presence or absence of bats and could consist of visual surveys at the time of emergence. If evidence of bat use is observed, the number and species of bats using the roost shall be determined. Bat detectors may be used to supplement survey efforts, but are not required. If no bat roosts are found, then no further study is required.</li> <li>▶ If bat roosts are determined to be present, the bats shall be excluded from the roosting site before the roost structure is removed. If roosts must be removed, a detailed mitigation program addressing compensation, exclusion methods, and roost removal procedures shall be developed, in consultation with CDFW, before implementation. Exclusion methods may include use of one-way doors at roost entrances (bats may leave but not reenter), or sealing roost entrances when the site can be confirmed to contain no bats. Exclusion efforts will be restricted during periods of sensitive activity (<i>e.g.</i>, during hibernation or while females in maternity colonies are nursing young).</li> <li>▶ Compensatory mitigation for the loss of each roost (if any) shall be developed, in consultation with CDFW, and may include construction and installation of bat boxes suitable to the bat species and colony size excluded from the original roosting site. Roost replacement will be implemented before bats are excluded from the original roost site. Once compensation is implemented and it is confirmed that bats are not present in the roost site, the roost structure may be removed.</li> </ul>	Stanislaus County.	Before rehabilitation of the former air traffic control tower.	Stanislaus County and CDFW.

Impact	Mitigation Measure	Implementation	Timing	Enforcement
<p>3.4-5 Loss of federally protected waters of the United States.</p>	<p><b>3.4-5: Compensate for Loss of Wetlands and Other Waters.</b></p> <p>The following measures shall be implemented:</p> <ul style="list-style-type: none"> <li>▶ The County shall obtain a USACE Section 404 Individual Permit and Central Valley RWQCB Section 401 water quality certification before any groundbreaking activity within 50 feet of waters or discharge of fill or dredge material into any water of the United States.</li> <li>▶ The County shall replace or restore on a “no-net-loss” basis the function of all wetlands and other waters that would be removed as a result of implementing backbone infrastructure to support project development. Wetland habitat will be restored or replaced at an acreage and location and by methods agreeable to USACE and the Central Valley RWQCB, depending on agency jurisdiction, and as determined during the Section 401 and Section 404 permitting processes.</li> <li>▶ Based on the presence of an on-site airport, all mitigation that has the potential to attract potentially hazardous wildlife must occur at an off-site location that is 10,000 feet or more from aircraft movement areas. Off-site mitigation methods may consist of the establishment of aquatic resources in upland habitats where they did not exist previously, reestablishment (restoration) of natural historic functions to a former aquatic resource, enhancement of an existing aquatic resource to heighten, intensify, or improve aquatic resource functions, or a combination thereof. The compensatory mitigation may be accomplished through purchase of credits from a USACE-approved mitigation bank, payment into a USACE-approved in-lieu fee fund, or through permittee-responsible off-site establishment, reestablishment, or enhancement, depending on availability of mitigation credits.</li> <li>▶ Permittee-responsible mitigation shall be monitored for a minimum of 5 years from completion of mitigation, or human intervention (including recontouring and grading), or until the success criteria identified in the approved mitigation plan have been met, whichever is longer.</li> </ul>	<p>Stanislaus County.</p>	<p>Before any ground-disturbing activities for any project development in areas containing wetland features or other waters of the United States and on an ongoing basis, as appropriate.</p>	<p>Stanislaus County, USACE, and/or Central Valley RWQCB, as appropriate.</p>

Impact	Mitigation Measure	Implementation	Timing	Enforcement
<b>3.5 Cultural Resources</b>				
<p>3.5-2 Substantial adverse change in the significance of an archaeological resource as defined in CEQA Guidelines Section 15064.5.</p>	<p><b>3.5-2: Avoid Potential Effects on Previously Undiscovered Resources, and Stop Work if Any Prehistoric or Historic Subsurface Cultural Resources are Discovered</b></p> <p>In the event that any prehistoric or historic subsurface archaeological features or deposits, including locally darkened soil (“midden”), are discovered during construction-related earth-moving activities, all ground-disturbing activity within 150 feet of the resources shall be halted.</p> <p>The County shall consult with a qualified archeologist to assess the significance of the find. If the feature is determined to be significant by the qualified archaeologist (i.e., because it is determined to constitute either an historical resource or a unique archaeological resource), representatives of the County and the qualified archaeologist shall meet to determine the appropriate course of action.</p> <p>If the archaeologist determines that some or all of the affected resource qualifies as a historical resource or a Native American Cultural Place, including a Native American sanctified cemetery, place of worship, religious or ceremonial site, sacred shrine (California Public Resources Code Section 5097.9), or a Native American historic, cultural, or sacred site that is listed or may be eligible for listing in the California Register of Historical Resources pursuant to California Public Resources Code Section 5024.1, including any historic or prehistoric ruins, any burial ground, or any archaeological or historic site (California Public Resources Code Section 5097.993), the archaeologist shall recommend to the County potentially feasible mitigation measures that would preserve the integrity of the site or minimize impacts on it, including any or a combination of the following:</p> <ul style="list-style-type: none"> <li>▶ Avoidance, preservation, and/or enhancement of all or a portion of the Native American Cultural Place as open space or habitat, with a conservation easement dedicated to the most interested and appropriate tribal organization. If such an organization is willing to accept and maintain</li> </ul>	<p>Stanislaus County and leaseholders / developers / contractors.</p>	<p>During the construction of any on-site developments and off-site infrastructure improvements and ongoing, as applicable.</p>	<p>Stanislaus County.</p>

Impact	Mitigation Measure	Implementation	Timing	Enforcement
	<p>such an easement, or alternatively, a cultural resource organization that holds conservation easements;</p> <ul style="list-style-type: none"> <li>▶ An agreement with any such tribal or cultural resource organization to maintain the confidentiality of the location of the site so as to minimize the danger of vandalism to the site or other damage to its integrity; or</li> <li>▶ Other measures, short of full or partial avoidance or preservation, intended to minimize impacts on the Native American Cultural Place consistent with land use assumptions and the proposed design and footprint of the development project for which the requested grading permit has been approved.</li> </ul> <p>After receiving such recommendations, the County shall assess the feasibility of the recommendations and impose the most protective mitigation feasible in light of land use assumptions and the proposed design and footprint of the development project. The County shall, in reaching conclusions with respect to these recommendations, consult with the most appropriate and interested tribal organization.</p>			
<b>3.7 Greenhouse Gas Emissions</b>				
3.7-1 Increases in greenhouse gas emissions.	<p><b>3.7-1a: Reduce Construction-Related GHG Emissions</b></p> <p>Development of the project shall incorporate measures to reduce GHG emissions associated with construction activities including, but not limited to construction equipment, haul trucks, material delivery trucks, and construction worker vehicles. Measures can include, but should not be limited to the following:</p> <ul style="list-style-type: none"> <li>▶ Contractor shall use alternative-fuel (<i>e.g.</i>, compressed natural gas) or electric equipment, when feasible.</li> <li>▶ Procure materials from providers from the closest feasible sources.</li> </ul>	Leaseholders / developers / contractors for projects under the Specific Plan and Stanislaus County for infrastructure improvements directed by the County.	During all construction activities.	Stanislaus County.
	<p><b>3.7-1b: Reduce Operational GHG Emissions</b></p> <p>Projects proposed under the Specific Plan shall incorporate energy efficiency, conservation, and other GHG reduction strategies. The performance standard is to incorporate</p>	Leaseholders / developers / contractors and Stanislaus County.	Identify strategies to reduce emissions prior to issuance of building permit and implement strategies during operations.	Stanislaus County.

Impact	Mitigation Measure	Implementation	Timing	Enforcement
	<p>reduction strategies at a sufficient level to contribute each project’s proportional share of the overall greenhouse gas reductions necessary to meet State GHG reduction targets. The following mitigation measures shall be implemented by the project applicant(s) of all project phases to reduce GHG emissions:</p> <ul style="list-style-type: none"> <li>▶ Provide electric vehicle charging stations and priority parking nearest to buildings.</li> <li>▶ Design roof top areas for proposed buildings to minimize the area occupied by heating, ventilation, and air conditioning (HVAC) systems and maximum the efficiency and area for solar PV systems that would be compatible with the proposed aviation facilities.</li> <li>▶ Orient and design buildings to maximize natural lighting and install passive energy efficiency features such as louvres and shade structures to minimize the amount of air conditioning needed during summer months.</li> <li>▶ Building indoor lighting shall be automatically switched to motion sensor and area lighting after normal working hours.</li> <li>▶ Provide all businesses with separate recycling containers for daily paper, plastic, cans, and glass generation and recycling pick up in coordination with general solid waste pick up.</li> <li>▶ Provide monthly e-waste collection services for all business.</li> </ul> <p>Projects that do not incorporate the measures listed above, shall propose alternative measures that demonstrate an equal or greater decrease in annual operational GHG emissions and achieve the performance standard.</p>			
<b>3.8 Geology, Soils, Minerals, and Paleontological Resources</b>				
3.8-1 Potential damage to proposed facilities from seismic hazards.	<p><b>3.8-1a: Prepare Site-Specific Geotechnical Report(s) per CBC Requirements and Implement Associated Recommendations.</b></p> <p>Prior to issuance of grading/building permits and prior to the construction of any off-site infrastructure improvements, a qualified civil engineer shall be retained to prepare a final geotechnical report for the proposed facilities, which shall</p>	Leaseholders / developers / contractors.	Prior to issuance of a grading/building permit.	Stanislaus County.

Impact	Mitigation Measure	Implementation	Timing	Enforcement
	<p>be submitted for review and approval to the appropriate Stanislaus County Department(s). The final geotechnical engineering report may require site-specific subsurface soil borings and shall address and make recommendations on the following, as applicable:</p> <ul style="list-style-type: none"> <li>▶ seismic design parameters;</li> <li>▶ seismic ground shaking;</li> <li>▶ surface fault rupture related to the proposed I-5 interchange improvements;</li> <li>▶ liquefaction;</li> <li>▶ expansive/unstable soils;</li> <li>▶ site preparation;</li> <li>▶ soil bearing capacity;</li> <li>▶ structural foundations, including retaining-wall design;</li> <li>▶ grading practices; and</li> <li>▶ soil corrosion of concrete and steel.</li> </ul> <p>In addition to the recommendations for the conditions listed above, the geotechnical investigation shall determine appropriate foundation designs that are consistent with the version of the California Building Code (CBC) that is in force at the time of permit application. Building plans shall demonstrate that they incorporate all applicable recommendations of the geotechnical study and comply with all applicable requirements of the latest adopted version of the CBC.</p> <p><b>3.8-1b: Monitor Earthwork during Earthmoving Activities.</b></p> <p>All earthwork, such as excavation, placement of fill, and disposal of materials removed from and deposited on both on-and off-site construction areas, shall be monitored by a qualified geotechnical or civil engineer.</p>	Leaseholders / developers / contractors.	During excavation or other earthwork.	Stanislaus County.
3.8-2 Potential geologic hazards related to construction in unstable soils.	<p><b>3.8-2c: Conduct Subsidence Monitoring.</b></p> <p>Subsidence monitoring shall be conducted and appropriate actions taken to prevent subsidence associated with the project. The County shall coordinate with the Groundwater</p>	Stanislaus County and the Groundwater Sustainability Agency.	Ongoing.	Stanislaus County and the Groundwater Sustainability Agency.

Impact	Mitigation Measure	Implementation	Timing	Enforcement
	<p>Sustainability Agency on any monitoring of subsidence monuments conducted to implement the Groundwater Sustainability Plan for the vicinity of the Specific Plan Area. The exact construction, placement, and monitoring methodology will be defined in a subsidence monitoring program in the Groundwater Sustainability Plan. Subsidence monitoring activities, findings, and reporting schedule will also be defined in the Groundwater Sustainability Plan, along with standards that dictate when investigation and intervention is required and what actions will be a part of intervention, if required, in order to avoid damage to infrastructure.</p>			
<p>3.8-3 Potential temporary, short-term construction-related erosion.</p>	<p><b>3.8-3a: Prepare and Implement a Grading and Erosion Control Plan.</b></p> <p>Before grading permits are issued or earthmoving activities are conducted, a California Registered Civil Engineer shall be retained to prepare a grading and erosion control plan. The grading and erosion control plan shall be submitted to the Stanislaus County Public Works Department for review and approval. The plan shall be consistent with the County's NPDES permit, and shall include site-specific grading proposals. The plan shall include the location, implementation schedule, and maintenance schedule of all erosion and sediment control measures, a description of measures designed to control dust and stabilize the construction-site road and entrance, and a description of the location and methods of storage and disposal of construction materials. Temporary construction-related erosion and sediment control measures could include the use of detention basins, berms, swales, wattles, and silt fencing, and covering or watering of stockpiled soils to reduce wind erosion. Stabilization of construction entrances to minimize trackout (control dust) is commonly achieved by installing filter fabric and crushed rock to a depth of approximately 1 foot.</p>	<p>Leaseholders / developers / contractors.</p>	<p>Prior to issuance of a grading permit.</p>	<p>Stanislaus County.</p>

Impact	Mitigation Measure	Implementation	Timing	Enforcement
3.8-7 Possible damage to or destruction of unique paleontological resources.	<p><b>3.8-7: Avoid Paleontological Resources Impacts.</b></p> <p>If paleontological resources (e.g., fossils) are discovered during earthmoving activities, the construction crew shall immediately cease work in the vicinity of the find and notify the Stanislaus County Planning &amp; Community Development Department. A qualified paleontologist shall be retained to evaluate the resource and prepare a recovery plan in accordance with Society of Vertebrate Paleontology Guidelines (1996). The recovery plan may include, but is not limited to, a field survey, construction monitoring, sampling and data recovery procedures, museum storage coordination for any specimen recovered, and a report of findings. Recommendations in the recovery plan that are determined by the Stanislaus County Planning &amp; Community Development Department to be necessary and feasible shall be implemented before construction activities can resume at the site where the paleontological resources were discovered.</p>	Stanislaus County.	During excavation and other earth disturbance.	Stanislaus County.
<b>3.9 Hazards and Hazardous Materials</b>				
3.9-1 Accidental spills and routine use and transport of hazardous materials used during construction activities.	<p><b>3.9-1: Designate Official Trucking Route.</b></p> <p>The County shall designate the official trucking terminal access route for the Specific Plan from the Fink Road/Interstate 5 interchange directly to the Specific Plan Area. This trucking route shall apply to large trucks regulated by the Surface Transportation Assistance Act, referred to as “STAA” trucks.</p>	Leaseholders / developers / contractors.	Establish prior to construction and enforce during construction and operation of projects implemented within the Specific Plan Area.	Stanislaus County.
3.9-2 Exposure of people and the environment to existing hazardous materials, including Cortese-listed sites.	<p><b>3.9-2a: Prepare and Implement a Worker Health and Safety Plan, and Implement Appropriate Measures to Minimize Potential Exposure to Hazardous Materials.</b></p> <p>The following shall be implemented before and during construction to reduce potentially significant impacts associated with exposure to hazardous materials:</p> <ul style="list-style-type: none"> <li>▶ Prepare and implement a worker health and safety plan before the start of construction activities that identifies, at</li> </ul>	Leaseholders / developers / contractors.	Before the start of earthmoving activities.	Stanislaus County.



Impact	Mitigation Measure	Implementation	Timing	Enforcement
	<p>a minimum, the potential types of contaminants that could be encountered during construction activity; all appropriate worker, public health, and environmental protection equipment and procedures to be used during project activities; emergency response procedures; the most direct route to the nearest hospitals; and a Site Safety Officer. The plan shall describe actions to be taken should hazardous materials be encountered on site, including the telephone numbers of local and state emergency hazmat response agencies.</p> <ul style="list-style-type: none"> <li>▶ If, during site preparation and construction activities, evidence of hazardous materials contamination is observed or suspected (<i>e.g.</i>, stained or odorous soil or groundwater), construction activities shall cease immediately in the area of the find. If such contamination is observed or suspected, the developer/contractor shall retain a qualified hazardous materials specialist to assess the site and collect and analyze soil and/or water samples, as necessary. If contaminants are identified in the samples, the developer/contractor shall notify and consult with the appropriate federal, State, and/or local agencies. Measures to remediate contamination and protect worker health and the environment shall be implemented in accordance with federal, State, and local regulations before construction activities may resume at the site where contamination is encountered. Such measures could include, but are not limited to, preparation of a Phase I and/or Phase II Environmental Site Assessment, removal of contaminated soil, and pumping and treating of groundwater.</li> <li>▶ Properly abandon and remove the existing agricultural ASTs in accordance with Stanislaus County Department of Environmental Resources regulations.</li> </ul>			
	<p><b>3.9-2b: Remove Asbestos-Containing Material and Lead-Based Paint in Accordance with Federal, State, and Local Regulations.</b></p> <p>The County shall retain a Cal-OSHA certified asbestos consultant before reuse, remodeling, or demolition of the</p>	Stanislaus County.	During construction activities at the control tower (building C101) and the airfield lighting vault (building C103).	Stanislaus County.

Impact	Mitigation Measure	Implementation	Timing	Enforcement
	<p>control tower (building C101) and the airfield lighting vault (building C103) to investigate whether any asbestos-containing materials or lead-based paints are present, and could become friable or mobile during rehabilitation or demolition activities. If any materials containing asbestos or lead-based paints are found, they shall be removed by an accredited contractor in accordance with EPA, Cal-OSHA, and SJVAPCD standards. In addition, all activities (construction or demolition) in the vicinity of these materials shall comply with Cal-OSHA asbestos and lead worker construction standards. The materials containing lead shall be disposed of properly at an appropriate off-site disposal facility.</p>			
	<p><b>3.9-2c: Design the I-5/Fink Road Interchange Improvements to Avoid Contact with Landfill Materials.</b></p> <p>Interchange improvements shall be designed to avoid all contact with landfill materials. The boundaries of existing landfill materials shall be clearly marked as an avoidance area prior to the start of construction activities at the interchange.</p>	Stanislaus County.	Prior to, and during construction activities associated with the I-5/Fink Road interchange improvements.	Stanislaus County.
	<p><b>3.9-2d: Perform an Environmental Site Assessment of the AL Castle Site, and Implement Remediation if Necessary.</b></p> <p>Prior to the start of construction activities associated with the sewer pipeline along West Marshall Road, a licensed environmental professional shall be retained to perform a Phase I Environmental Site Assessment (ESA) of the AL Castle site. The Phase I ESA shall include consultation with the Stanislaus County Department of Environmental Resources, and DTSC and/or SWRCB, regarding the status and nature of contamination of the AL Castle site. If necessary, a Phase II ESA shall be performed to obtain soil and groundwater samples for laboratory analysis. The Phase I ESA (and Phase II ESA, if necessary) shall be submitted to the Stanislaus County Department of Environmental Resources for review. Any necessary remedial activities shall be performed, prior to the start of any construction activities within 0.25 mile of the AL Castle property.</p>	Stanislaus County.	Prior to, and during construction activities associated with sewer pipeline.	Stanislaus County.

Impact	Mitigation Measure	Implementation	Timing	Enforcement
	Remedial activities shall be coordinated with the Stanislaus County Department of Environmental Resources (and DTSC and/or SWRCB, as necessary).			
3.9-4 Interference with emergency access or adopted emergency response plans.	<p><b>3.9-4: Prepare and Implement a Construction Traffic Control Plan.</b></p> <p>A traffic control plan shall be implemented for construction activities that may affect road rights-of-way, in order to facilitate travel of emergency vehicles on affected roadways. The traffic control plan must follow the applicable and current Stanislaus County <i>Standards and Specifications</i>, and must be approved and signed by a professional engineer. Measures typically used in traffic control plans include advertising of planned lane closures, warning signage, a flag person to direct traffic flows when needed, and methods to ensure continued access by emergency vehicles. During project construction, access to the existing surrounding land uses shall be maintained at all times, with detours used, as necessary, during road closures. The traffic control plan shall be submitted to the Stanislaus County Public Works Department for review and approval before the approval of all project plans or permits.</p>	Leaseholders / developers / contractors.	Prior to any construction activity that may affect road rights-of-way on- and off-site.	Stanislaus County.
<b>3.10 Hydrology and Water Quality</b>				
3.10-1 Potential temporary, short-term construction-related drainage and water quality effects.	<p><b>3.10-1b: Prepare and Implement a Stormwater Pollution Prevention Plan and Associated Best Management Practices.</b></p> <p>Prior to the start of earth-moving activities, leaseholders/developers/contractors for each project within the Specific Plan Area and for each off-site infrastructure improvement required to serve development under the Specific Plan shall obtain coverage under any applicable State or local stormwater permit for general construction activity, including the preparation and submittal of a project-specific storm water pollution prevention plan (SWPPP). The leaseholders/developers/contractors shall also prepare and submit erosion and sediment control and engineering plans and specifications for pollution</p>	Leaseholders / developers / contractors.	Prior to any earth-moving activities.	Stanislaus County.

Impact	Mitigation Measure	Implementation	Timing	Enforcement
	<p>prevention and control to the Stanislaus County Public Works Department.</p> <p>The SWPPP shall identify and specify an effective combination of robust erosion and sediment control Best Management Practices (BMPs) and construction techniques accepted by the County for use at the time of construction that would reduce the potential for runoff and the release, mobilization, and exposure of pollutants from project-related construction sites. Where applicable, BMPs identified in the SWPPP shall be in place throughout all site work and construction activities and shall be used in all subsequent site development activities.</p>			
<p>3.10-2 Potential increased risk of flooding and hydromodification from increased stormwater runoff</p>	<p><b>3.10-2: Prepare and Implement Drainage Plan Demonstrating Compliance with the County's Drainage Plan.</b></p> <p>All development shall implement all applicable design details within the County's approved drainage plan and shall provide project-specific details showing design measures to (1) protect long-term water quality; (2) ensure that future development continues to contain the 100-year (0.01 AEP) flood flows to avoid risk to people or structures within or down gradient of the project site; and (3) avoid an increase in hydromodification compared to pre-development levels that could change existing stream geomorphology. Plans demonstrating compliance with County drainage standards and project-specific details meeting the County's requirements and performance standards of this mitigation measure shall be submitted to and approved by the Stanislaus County Public Works Department. Plans shall contain supporting calculations, as determined necessary by the Public Works Director.</p>	<p>Leaseholders / developers / contractors.</p>	<p>Prior to issuance of grading or building permits and/or implementation of project construction.</p>	<p>Stanislaus County.</p>
<p>3.10-3 Create long-term operational water quality and hydrology effects as a result of agricultural and urban runoff.</p>	<p><b>3.10-3b: Prepare and Implement a Long-Term Site-Specific Operational Stormwater Quality Management Plan.</b></p> <p>The County shall implement a site-specific long-term operational stormwater quality/drainage management plan and incorporate procedures into all leases, contracts, and/or permits. The plan shall be designed to meet the</p>	<p>Stanislaus County and leaseholders / developers / contractors.</p>	<p>Prior to issuance of grading or building permits.</p>	<p>Stanislaus County.</p>

Impact	Mitigation Measure	Implementation	Timing	Enforcement
	<p>requirements of relevant permitting requirements, while acknowledging site-specific conditions and the presence of a nearby public-use airport. The plan shall outline the water quality improvements developed for the backbone infrastructure and provide detailed information about the structural and nonstructural BMPs proposed for phased project development. The plan shall include:</p> <ul style="list-style-type: none"> <li>▶ A quantitative hydrologic and water quality analysis of proposed conditions incorporating the site-specific drainage design features (including LID features).</li> <li>▶ Pre-development and post-development calculations demonstrating that the proposed water quality BMPs meet or exceed requirements established by Stanislaus County.</li> </ul> <p>The operational stormwater quality management plan shall contain a list of long-term operational BMPs that would be implemented throughout the project site to:</p> <ul style="list-style-type: none"> <li>▶ eliminate non-stormwater discharges;</li> <li>▶ educate future on-site employees about the stormwater program requirements and the penalties for non-stormwater discharges;</li> <li>▶ reduce the amount of pollutants carried by on-site stormwater; and</li> <li>▶ treat on-site stormwater prior to off-site discharge.</li> </ul> <p>Vegetation will be incorporated in to individual development plans, in accordance with Specific Plan policies. In addition, the project site shall be developed to include stormwater management facilities that promote evapotranspiration, infiltration, harvest/use, and biotreatment of stormwater and it shall include provisions to maintain these facilities in perpetuity. The facilities shall be designed using either volumetric or flow-based criteria as follows:</p> <p><b>Volumetric Hydraulic Sizing Design Criteria</b></p> <ul style="list-style-type: none"> <li>▶ The maximized capture stormwater volume for the tributary area, on the basis of historical rainfall records, determined using the formula and volume capture coefficients as required by Stanislaus County (i.e.,</li> </ul>			

Impact	Mitigation Measure	Implementation	Timing	Enforcement
	<p>approximately the 85th percentile 24-hour storm runoff event); or</p> <ul style="list-style-type: none"> <li>▶ The volume of annual runoff required to achieve 80 percent or more capture, determined in accordance with the methodology in Section 5 of the California Stormwater Quality Association (CASQA's) <i>Stormwater Best Management Practice Handbook, New Development and Redevelopment</i> (2003), using local rainfall data.</li> </ul> <p><b>Flow-Based Hydraulic Sizing Design Criteria</b></p> <ul style="list-style-type: none"> <li>▶ The flow of runoff produced from a rain event equal to at least 0.2 inches per hour intensity; or</li> <li>▶ The flow of runoff produced from a rain event equal to at least 2 times the 85th percentile hourly rainfall intensity as determined from local rainfall records.</li> </ul> <p>In addition, any future land use within the project site that includes a high-risk pollutant discharge source shall provide additional site-specific treatment to address pollutants of concern prior to the flow reaching the infiltration facility. The adequacy of site-specific source treatment shall be determined by the County, and may include facilities, such as oil and grease separators and settling tanks.</p> <p>The operational stormwater quality management plan for each proposed leasehold development shall be submitted to the County for review and approval.</p>			
	<p><b>3.10-3c: Implement an Agreement between Project Leaseholders and Stanislaus County to Provide Maintenance, Monitoring, and Funding for Long-Term Operational Stormwater Quality Control.</b></p> <p>Prior to issuance of building permits for proposed development in the Specific Plan Area, leaseholders shall be required to enter into an agreement with the County that specifies the long-term maintenance, monitoring, and funding for operational stormwater quality controls at the project site.</p>	Leaseholders / developers / contractors.	Prior to issuance of grading or building permits.	Stanislaus County.

Impact	Mitigation Measure	Implementation	Timing	Enforcement
<p>3.10-4 Potential impacts on groundwater recharge and aquifer volume.</p>	<p><b>3.10-4a: Provide Setbacks for New Shallow Wells</b></p> <p>New shallow groundwater extraction wells shall be located at least 250 feet from project site boundaries to minimize potential drawdown effects on shallow aquifer wells located on nearby properties.</p>	<p>Stanislaus County.</p>	<p>Ongoing.</p>	<p>Stanislaus County.</p>
	<p><b>3.10-4b: Conduct and Report Groundwater Level Monitoring</b></p> <p>The County shall coordinate with the Groundwater Sustainability Agency to conduct groundwater monitoring as a part of implementation of the Groundwater Sustainability Plan for the vicinity of the Specific Plan Area. The exact construction, placement, and monitoring methodology will be defined in a groundwater level monitoring program in the Groundwater Sustainability Plan. Groundwater level monitoring activities, findings, and reporting schedule will also be defined in the Groundwater Sustainability Plan, along with the Minimum Thresholds and Measurable Objectives required in a Groundwater Sustainability Plan that govern when investigation and intervention is required and what adjustments to well field operation or other actions are required to avoid effects to existing off-site wells. Groundwater level monitoring shall commence prior to project implementation to establish baseline conditions.</p>	<p>Stanislaus County and the Groundwater Sustainability Agency.</p>	<p>Ongoing.</p>	<p>Stanislaus County and the Groundwater Sustainability Agency.</p>
<p>3.10-5 Placement of structures that would impede or redirect flood flows within a 100-year flood hazard area.</p>	<p><b>3.10-5: Prepare Site-Specific Hydraulic Studies to Appropriately Design Water Crossings to Pass 100-Year Flood Flows.</b></p> <p>Prior to construction of any roadway crossings over any waterbodies (e.g., Little Salado Creek, or the Delta-Mendota Canal, a licensed civil engineer shall be retained to prepare a site-specific hydraulic analysis investigating the channel capacity of the waterbody above and below the proposed crossing structure. The report shall determine site-specific streamflow volume and velocity under 100-year flood stage conditions at the proposed stream crossing locations, as required by the <i>Stanislaus County Standards and</i></p>	<p>Stanislaus County.</p>	<p>Prior to construction of any roadway crossing over Little Salado Creek or the Delta-Mendota Canal.</p>	<p>Stanislaus County.</p>

Impact	Mitigation Measure	Implementation	Timing	Enforcement
	<p><i>Specifications</i> (Stanislaus County 2014). Overcrossings over the Delta-Mendota Canal shall be coordinated with the Delta-Mendota Water Authority and/or DWR, respectively. The analysis shall include runoff calculations for any upstream development that may have occurred between preparation of this EIR and the time of the site-specific hydraulic analysis, either off or on-site. The hydraulic analysis shall be used to determine the appropriate bridge or culverted crossing design, and the results of the hydraulic analysis shall demonstrate that the proposed creek crossing structure will not impair 100-year flood flows associated with the waterbody. The hydraulic report, along with the proposed bridge or culverted crossing design, shall be submitted to the Stanislaus County Departments of Public Works for review and approval. All bridge and culvert designs shall be in accordance with the California Department of Transportation’s Bridge Design Specifications and <i>Stanislaus County Standards and Specifications</i> (Stanislaus County 2015). For example, current county specifications require that for pipe culverts, all headwalls or other appurtenant structures must be located adjacent to the right-of-way and the maximum fill slope over culverts must be 4 to 1 or flatter. The County also requires all fill placed within 2 feet above the 100-year flood (Q<sub>100</sub>) elevation be protected from erosion by slope protection.</p>			
<p>3.10-6 Potential exposure of people or structures to a significant risk of flooding as a result of the failure of a levee or dam, including flooding from a seismic seiche.</p>	<p><b>3.10-6: Prepare a Site-Specific Levee Design Report and Incorporate Appropriate Design and Engineering Recommendations.</b></p> <p>Depending on the height of the Davis Road Levee, the project could be subject to Division of Safety of Dams (DSOD) jurisdiction. If so, the levee shall be designed, operated, and maintained according to applicable DSOD criteria. If not, the levee shall be designed according to standard geotechnical and civil engineering criteria by a California-licensed engineer, which may include specifications such as those contained in USACE Engineering Manual 1110-2-1913 <i>Design and Construction of Levees</i> (USACE 2000), Engineering Technical Letter</p>	<p>Stanislaus County.</p>	<p>Prior to construction of Davis Road Levee.</p>	<p>Stanislaus County.</p>



Impact	Mitigation Measure	Implementation	Timing	Enforcement
	(ETL) 1110-2-569, <i>Design Guidance for Levee Underseepage</i> (USACE 2005), and ETL 1110-2-555, <i>Design Guidance on Levees</i> (USACE 1997).			
<b>3.12 Noise and Vibration</b>				
3.12-1 Potential exposure of noise-sensitive receptors to groundborne noise and vibration.	<p><b>3.12-1: Implement Noise and Vibration Measures from Construction Traffic.</b></p> <p>For construction traffic that could affect sensitive receptors:</p> <ul style="list-style-type: none"> <li>▶ Prepare a truck route plan. For vibration impacts, the truck route plan will route heavily loaded trucks away from roads where residences are within 50 feet of the edge of the roadway. Heavily loaded trucks will not be routed on West Marshall Road and any other roads that are located within 50 feet of residential or any other vibration-sensitive buildings. For noise impacts, the truck route plan will route trucks away from residential streets where residences or noise-sensitive uses are within 640 feet of the roadway.</li> <li>▶ Operate earthmoving equipment on the construction lot as far away from vibration-sensitive sites as possible.</li> <li>▶ Phase earthmoving and other construction activities that would affect the ground surface so as not to occur in the same time period.</li> <li>▶ Large bulldozers and other construction equipment that would produce vibration levels at or above 86 VdB shall not be operated within 50 feet of adjacent, occupied residences. Small bulldozers shall be used instead of large bulldozers in these areas, if construction activities are required. For any other equipment types that would produce vibration levels at or above 86 VdB, smaller versions or different types of equipment shall be substituted for construction areas within 50 feet of adjacent, occupied residences.</li> <li>▶ Construction activities shall not occur on weekends or federal holidays and shall not occur on weekdays between the hours of 7 p.m. and 7 a.m.</li> </ul>	Leaseholders / developers / contractors and Stanislaus County.	During all construction phases.	Stanislaus County.

Impact	Mitigation Measure	Implementation	Timing	Enforcement
3.12-2 Increase traffic noise levels at noise-sensitive receptors.	<p><b>3.12-2: Surfacing the Pavement along the Impacted Roadway Segment with Rubberized Asphalt Material</b></p> <p>Resurfacing of Bell Road from Fink Road to Ike Crow Road, and Fink Road from Bell Road to SR 33 shall use rubberized asphalt, in accordance with Chapter 1100 of the California Highway Design Manual.</p>	Stanislaus County.	Prior to completion of Phase 1.	Stanislaus County.
3.12-3 Long-term exposure of sensitive receptors to non-transportation noise sources.	<p><b>3.12-3: Placement and Orientation of Day Care Uses.</b></p> <p>Future day care uses shall be located and/or oriented so that noise-sensitive outdoor activity areas are not exposed to noise levels exceeding 65dB CNEL, the level of noise deemed acceptable in the vicinity of an airport according to the California Code of Regulations.</p>	Leaseholders / developers / contractors.	Ongoing.	Stanislaus County.
3.12-4 Short-Term Exposure of Sensitive Receptors to Construction Noise.	<p><b>3.12-4: Implement Construction Equipment Noise Reduction Measures.</b></p> <p>The following measures shall be implemented to minimize construction noise impacts for powered construction equipment operating within 500 feet of existing noise-sensitive uses:</p> <ul style="list-style-type: none"> <li>▶ Construction activities shall not occur on weekends, federal holidays, or on weekdays between the hours of 7 p.m. and 7 a.m.</li> <li>▶ Locate fixed/stationary equipment (e.g., generators, compressors) as far as possible from noise-sensitive receptors. Shroud or shield all impact tools, and muffle or shield all in-take and exhaust ports on powered construction equipment.</li> <li>▶ Store and maintain equipment as far as possible from noise-sensitive receptors.</li> <li>▶ Properly maintain and equip all construction equipment with noise-reduction intake and exhaust mufflers and engine shrouds, in accordance with manufacturers' recommendations. Equipment engine shrouds shall be closed during equipment operation.</li> </ul>	Leaseholders / developers / contractors for future developments and Stanislaus County for County-led infrastructure improvements.	During all construction phases.	Stanislaus County.

Impact	Mitigation Measure	Implementation	Timing	Enforcement
	<ul style="list-style-type: none"> <li>▶ Shut down all motorized construction equipment when not in use to prevent excessive idling noise.</li> </ul>			
<b>3.14 Traffic and Transportation</b>				
<p>3.14-1 Existing plus project – intersection operations.</p>	<p><b>3.14-1: Off-site Traffic Signal or Roundabout Installations and Intersection Improvements.</b></p> <p>The following intersections are expected to meet signal warrants during peak-hour periods when the project is in place. The impact can be alleviated by installing traffic signals at the intersections where LOS would be degraded in exceedance of relevant thresholds. The affected jurisdictions can consider roundabouts as an alternative to traffic signals. The project shall contribute on a fair-share basis to the following improvements.</p> <p><u>Phase 1</u></p> <ul style="list-style-type: none"> <li>▶ Signalize Intersection 14. Sperry Avenue / SR 33 (Caltrans)</li> <li>▶ Signalize Intersection 24. West Ike Crow Road / SR 33 (Stanislaus County)</li> <li>▶ Signalize Intersection 26. Fink Road / Bell Road (Stanislaus County)</li> <li>▶ Signalize Project Entrance / Fink Road (Stanislaus County)</li> </ul> <p><b>Fink Road Interchange</b> – Contribute on a fair-share basis to the improvement of the Fink Road interchange. Improvements recommended for the Fink Road interchange include signalizing the northbound ramps prior to completion of Phase 1 and widening the roadway beneath the freeway to create a westbound left turn lane at the southbound ramps intersection.</p> <p><u>Phase 2</u></p> <ul style="list-style-type: none"> <li>▶ Signalize Intersection 20. Marshall Road / SR 33 (Caltrans)</li> <li>▶ Signalize Intersection 22. Marshall Road / Ward Avenue (Stanislaus County)</li> <li>▶ Signalize Intersection 25. Fink Road / SR 33 (Stanislaus County)</li> </ul>	<p>Leaseholders / developers / contractors will contribute on a fair-share basis to fee to reimburse for off-site improvements and implementation will be directed by Stanislaus County.</p>	<p>Prior to completion of Phase 1 and Phase 2, as specified.</p>	<p>Stanislaus County.</p>

Impact	Mitigation Measure	Implementation	Timing	Enforcement
3.14-2 Existing plus project – roadway segment operations.	<p><b>3.14-2: Off-site Street Widening to Four Lanes on Marshall Road from Project Entrance to SR 33.</b></p> <p>Marshall Road between the project entrance and SR 33 shall be widened from two to four lanes to accommodate project-generated daily traffic.</p>	Leaseholders / developers / contractors will contribute on a fair-share basis to fee to reimburse for off-site improvements and implementation will be directed by Stanislaus County.	Prior to completion of Phase 2.	Stanislaus County and Caltrans.
<b>3.15 Utilities and Service Systems</b>				
3.15-5 Increased demand at City of Patterson Water Quality Control Facility (WQCF).	<p><b>3.15-5: Demonstrate Adequate Wastewater Treatment Capacity.</b></p> <p>Before the County will issue any building permit for a use proposing to connect to public sewer or construction of backbone sewer infrastructure connecting to the WHWD sewer line, the project applicant shall be required to provide written documentation to verify that existing treatment capacity is, or will be, available at the WQCF to support the proposed development. If treatment capacity is provided at the City of Patterson WQCF, projects within the Specific Plan Area shall contribute on a fair-share basis to the cost associated with such treatment capacity. Written documentation may include proof of executions of all financing agreements and/or other mechanisms, to the satisfaction of the City of Patterson, to ensure that any physical improvements required to treat wastewater associated with the proposed development will be in place prior to occupancy.</p>	Leaseholders / developers / contractors.	Prior to issuance of any building permits for a use proposing to connect to public sewer or construction of backbone sewer infrastructure connecting to the WHWD sewer line.	Stanislaus County.
<b>Cumulative Impacts</b>				
TRANSPORTATION AND TRAFFIC – Cumulative with Project Conditions – Intersection Operations	<p><b>Mitigation Measure – Cumulative with Project Transportation 1: Traffic Signal Installation</b></p> <p>The project shall contribute on a cumulative fair-share basis to the signalizations for Intersections 1, 2, 10, 11, 14, 17, 18, 19, 20, and 25. The project shall also contribute on a cumulative fair-share basis, in coordination with the City of Newman, to the signalization of the following intersections:</p> <ul style="list-style-type: none"> <li>▶ Fink Road / Davis Road (Stanislaus County)</li> </ul>	Stanislaus County and Caltrans.	Prior to completion of Phase 3.	Stanislaus County and Caltrans.

Impact	Mitigation Measure	Implementation	Timing	Enforcement
	<ul style="list-style-type: none"> <li>▶ Fink Road / Ward Avenue (Stanislaus County)</li> <li>▶ I-5 NB Ramps/ Fink Road (Caltrans)</li> <li>▶ I-5 SB Ramps/ Fink Road (Caltrans)</li> <li>▶ SR 33 intersections with Stuhr Road, Jensen Road, Yolo Street, and Inyo Street.</li> </ul>			
<p>TRANSPORTATION AND TRAFFIC – Cumulative with Project Conditions – Roadway Segment Operations</p>	<p><b>Mitigation Measure – Cumulative with Project Transportation 2: Roadway Widening</b></p> <p>The project shall contribute on a cumulative fair-share basis to the improvement to Roadway Segment 16, West Main Street west of Carpenter Road: from two to four lanes, and the improvement to Roadway Segment 19, I-5 north of Sperry Avenue: from four to six lanes. The project shall also contribute on a cumulative fair-share basis to the following roadway widening improvements:</p> <ul style="list-style-type: none"> <li>▶ Roadway Segment 4. SR 33 south of Stuhr Road to Inyo Street: from two to four lanes</li> <li>▶ Roadway Segment 8. SR 33 between Marshall Road and Sperry Avenue: from two to four lanes</li> <li>▶ Roadway Segment 20. I-5 between Fink Road and Sperry Avenue: from four to six lanes</li> </ul>	<p>Stanislaus County and Caltrans.</p>	<p>Prior to completion of Phase 3.</p>	<p>Stanislaus County and Caltrans.</p>

This page is intentionally blank.