

## **Chapter One**

# **LAND USE ELEMENT**

## **INTRODUCTION**

The Land Use Element designates the type, intensity, and general distribution of uses of land for housing, business, industry, open space, agriculture, natural resources, recreation, education, public buildings and grounds, solid and liquid waste disposal facilities, and other categories of public and private uses of land.

The goals and policies of the Land Use Element, supported by implementation measures, are designed to:

- 1) Provide for diverse land use needs;
- 2) Ensure compatibility between land uses;
- 3) Foster stable economic growth;
- 4) Ensure that an effective level of public service is provided;
- 5) Complement the general plan of cities within the County;
- 6) Promote and protect healthy living environments; and
- 7) Provide for direct citizen participation in land use expansions of residential uses into agricultural and open-space areas.

Included in the Land Use Element are Community Plans (text and land use maps) for most of the unincorporated communities in Stanislaus County; along with Historical Standards for the communities of Knights Ferry and La Grange, and Design Guidelines for the community of Salida.

***THIS PAGE INTENTIONALLY LEFT BLANK***

## GOALS, POLICIES AND IMPLEMENTATION MEASURES

### GOAL ONE

Provide for diverse land use needs by designating patterns which are responsive to the physical characteristics of the land as well as to environmental, economic, and social concerns of the residents of Stanislaus County.

### POLICY ONE

Land will be designated and zoned for agricultural, residential, commercial, industrial, or historical uses when such designations are consistent with other adopted goals and policies of the General Plan.

### IMPLEMENTATION MEASURES

1. In reviewing proposals for amendments to land use designations, the County shall evaluate how the proposal would advance the long-term goals of the County.  
**Responsible Departments: Planning, Planning Commission, Board of Supervisors**
2. The zoning district map of the County shall be reviewed as needed to verify that no conflicts exist between land use designations, zoning districts, and other applicable plans or regulations, including but not limited to Airport Land Use Commission / Compatibility Plans.  
**Responsible Department: Planning**

### POLICY TWO

Land designated Agriculture shall be restricted to uses that are compatible with agricultural practices, including natural resources management, open space, outdoor recreation, and enjoyment of scenic beauty.

### IMPLEMENTATION MEASURE

1. Agricultural areas should generally be zoned for 40- to 160-acre minimum parcel sizes. Exceptions include land in a ranchette area so identified because of significant existing parcelization of property, poor soils, location, and other factors which limit the agricultural productivity of the area.  
**Responsible Departments: Agricultural Commissioner, Planning, Planning Commission, Board of Supervisors**

## **POLICY THREE**

Land use designations shall be consistent with the criteria established in this element.

### **IMPLEMENTATION MEASURE**

1. Requests for General Plan amendments shall be carefully reviewed for consistency with the criteria established in the **LAND USE DESIGNATIONS** section of this element for locating these designations. Applications which are inconsistent shall be denied.  
**Responsible Departments: Planning, Planning Commission, Board of Supervisors**

## **POLICY FOUR**

Urban development shall be discouraged in areas with growth-limiting factors such as high water table or poor soil percolation, and prohibited in geological fault and hazard areas, flood plains, riparian areas, and airport and private airstrip hazard areas, unless measures to mitigate the problems are included as part of the application.

### **IMPLEMENTATION MEASURES**

1. All requests for development which require discretionary approval and include lands adjacent to or within riparian habitat shall include measures for protecting that habitat.  
**Responsible Departments: Agricultural Commissioner, Planning, Planning Commission, Board of Supervisors**
2. Applications for development in areas with growth-limiting factors such as high water table, poor soil percolation, geological fault areas, flood plains, and airport hazard areas shall include measures to mitigate the problems.  
**Responsible Departments: Public Works, Environmental Resources, Planning, Planning Commission, Board of Supervisors**
3. Development within the 100-year flood boundary shall meet the requirements of Chapter 16.50 (Flood Damage Prevention) of the County Code, and within the designated floodway shall obtain Central Valley Flood Protection Board approval.  
**Responsible Departments: Public Works, Planning, Planning Commission, Board of Supervisors**
4. The County shall enforce all applicable codes and regulations, including adopted Airport Land Use Compatibility Plans, restricting heights near airports.  
**Responsible Departments: Planning, Board of Supervisors**
5. The County shall enforce the provisions of the Alquist-Priolo Earthquake Fault Zoning Act that limits development in areas identified as having special seismic hazards. See Figure V-2-of the Safety Element for the location of the zone.  
**Responsible Departments: Public Works, Planning, Planning Commission, Board of Supervisors**

## **POLICY FIVE**

Residential densities, as defined in the General Plan, shall be the maximum based upon environmental constraints, the availability of public services, and acceptable service levels. The densities reflected may not always be achievable and shall not be approved unless there is proper site planning and provision of suitable open space and recreational areas consistent with the supportive goals and policies of the General Plan.

### **IMPLEMENTATION MEASURE**

1. Residential development shall not be approved at the maximum density if: (1) it threatens riparian habitat; (2) growth-limiting factors such as high water table, poor soil percolation, geological fault areas, and airport hazard areas exist; (3) development is in a designated floodway or does not meet the requirements of Chapter 16.50 of the County Code; (4) it conflicts with the Airport Land Use Compatibility Plan; (5) there is lack of, or inadequate, sanitary sewer or public water service; or (6) environmental impacts, including traffic, cannot be mitigated.

***Responsible Departments: Public Works, Environmental Resources, Planning, Planning Commission, Board of Supervisors***

## **POLICY SIX**

Preserve and encourage upgrading of existing unincorporated urban communities.

### **IMPLEMENTATION MEASURES**

1. The County shall support state efforts to reestablish redevelopment tools utilizing tax increment for the purpose of upgrading existing unincorporated urban communities.

***Responsible Departments: Planning, Planning Commission, Board of Supervisors***

2. The County will apply for federal and state funds to aid in upgrading existing urban areas.

***Responsible Department: Parks and Recreation, County Executive Office, Board of Supervisors***

3. Land within the sphere of influence of a community services district, sanitary district, or domestic water district shall be rezoned for development only if capacity for connecting to available public services exists and any resulting projects are conditioned to restrict development from occurring until annexation to or formation of the required district is complete.

***Responsible Departments: Planning, Planning Commission, Board of Supervisors***

4. When feasible, new development shall be designed and built to allow for the upgrading or expansion of services necessary to upgrade existing unincorporated urban communities; however, new development will not be expected to be financially responsible for providing upgrades.

***Responsible Departments: Planning, Planning Commission, Board of Supervisors***

5. The County shall support and assist unincorporated urban communities in their efforts to establish “self-help” programs (such as assessment financing districts) necessary to upgrade their communities.

***Responsible Departments: Planning, Planning Commission, Board of Supervisors***

## **POLICY SEVEN**

Riparian habitat along the rivers and natural waterways of Stanislaus County shall, to the extent possible, be protected.

### **IMPLEMENTATION MEASURE**

1. All requests for development which require discretionary approval and include lands adjacent to or within riparian habitat shall include measures for protecting that habitat to the extent that such protection does not pose threats to proposed site uses, such as airports.

***Responsible Departments: Planning, Planning Commission, Board of Supervisors***

## **POLICY EIGHT**

The County will continue to provide proper ordinances to ensure that flood insurance can be made available to qualified property owners through state and federal programs.

### **IMPLEMENTATION MEASURE**

1. Development within the 100-year flood boundary shall meet the requirements of Chapter 16.50 (Flood Damage Prevention) of the County Code and within the designated floodway shall obtain Central Valley Flood Protection Board approval.

***Responsible Departments: Public Works, Planning, Planning Commission, Board of Supervisors***

## **POLICY NINE**

The Land Use Element shall be maintained so that it is responsive to change.

### **IMPLEMENTATION MEASURES**

1. The Land Use Element shall be comprehensively reviewed by the General Plan Update Committee (GPUC) as found necessary by the Board of Supervisors. Every attempt shall be made to do so at least once every five years.

***Responsible Departments: Planning, Planning Commission, Board of Supervisors***

2. All of the community plans shall be reviewed and updated as found necessary by the Board of Supervisors. Substantial changes to these plans shall be permitted only in conjunction with a complete community plan update unless the Director of Planning and Community Development finds that (1) the plan has been completely updated within the past three years and the proposed changes can be adequately evaluated based on that updated plan or (2) the proposed change will have no major or demonstrable impact on the surrounding area or on the community in general.

***Responsible Departments: Planning, Planning Commission, Board of Supervisors***

3. An annual report shall be made to the Board of Supervisors on the status of the General Plan and progress in its implementation as required in California Government Code Section 65400 (a).  
***Responsible Department: Planning***

## **POLICY TEN**

New areas for urban development (as opposed to expansion of existing areas) shall be limited to less productive agricultural areas.

## **IMPLEMENTATION MEASURES**

1. Requests for designation of new urban areas shall be reviewed by the County to determine whether the land is located in a less productive agricultural area based on considerations identified in the Agricultural Element.  
***Responsible Departments: Agricultural Commissioner, Planning, Planning Commission, Board of Supervisors***
2. Requests for designation of new urban areas shall be accompanied by a plan and implementation methods to provide all appropriate urban services.  
***Responsible Departments: Public Works, Environmental Resources, Fire Warden's Office and the Local Fire Agency Having Jurisdiction, Sheriff, Parks and Recreation, Library, Planning, Planning Commission, Board of Supervisors***
3. Proposed amendments to the General Plan map that would allow the conversion of agricultural land to non-agricultural uses shall be approved only if they are consistent with the conversion criteria stated in the Agricultural Element.  
***Responsible Departments: Planning, Planning Commission, Board of Supervisors***

***THIS PAGE INTENTIONALLY LEFT BLANK***



## GOAL TWO

Ensure compatibility between land uses.

### POLICY ELEVEN

Development of residential areas shall be adjacent to existing compatible unincorporated urban development or, in the case of remote development, included as part of a specific plan.

#### IMPLEMENTATION MEASURE

1. The criteria for location of residential areas as described in the **LAND USE DESIGNATIONS** section of this element shall be applied to all requests for residential designation.  
**Responsible Departments: Planning, Planning Commission, Board of Supervisors**

### POLICY TWELVE

The expansion of urban boundaries of unincorporated communities shall attempt to minimize conflict between various land uses.

#### IMPLEMENTATION MEASURES

1. The County shall ensure that expansion of urban boundaries of unincorporated communities is accomplished in an orderly manner to limit the area of conflict as much as possible. Substantial changes to community plans shall be permitted only as specified under Policy Nine, Implementation Measure 2.  
**Responsible Departments: Agriculture Commissioner, Planning, Planning Commission, Board of Supervisors**
2. Before redesignating land designated Agriculture in the General Plan in the process of expanding an existing unincorporated community, the County shall require that the existing community plan be updated or, if a community plan does not already exist, that one be adopted.  
**Responsible Departments: Planning, Planning Commission, Board of Supervisors**
3. In the process of establishing a new, self-contained community, the County shall require that a specific plan be adopted before approving the redesignation of any land designated Agriculture in the General Plan.  
**Responsible Departments: Planning, Planning Commission, Board of Supervisors**

### POLICY THIRTEEN

Expansion of urban boundaries of unincorporated communities should be based on infilling and elimination of existing "islands" and should not permit leapfrog development or create new "islands."

#### IMPLEMENTATION MEASURE

1. The County shall not approve applications (such as General Plan amendments, rezones, or tentative maps) for expansion of urban boundaries of unincorporated communities that would create "islands" or disregard infilling.  
**Responsible Departments: Planning, Planning Commission, Board of Supervisors**

## **POLICY FOURTEEN**

Uses shall not be permitted to intrude into or be located adjacent to an agricultural area if they are detrimental to continued agricultural usage of the surrounding area.

### **IMPLEMENTATION MEASURES**

1. All development proposals that require discretionary action shall be carefully reviewed to ensure that approval will not adversely affect an existing agricultural area.  
**Responsible Departments: Agricultural Commissioner, Planning, Planning Commission, Board of Supervisors**
2. Proposed amendments to the General Plan map that would allow the conversion of agricultural land to non-agricultural uses shall be approved only if they are consistent with the County's conversion criteria, as stated in the Agricultural Element.  
**Responsible Departments: Agricultural Commissioner, Planning, Planning Commission, Board of Supervisors**

## **POLICY FIFTEEN**

Uses should not be permitted to intrude into, or be located adjacent to, areas that are identified as existing and/or potential sites for solid waste facilities if such uses would not be compatible.

### **IMPLEMENTATION MEASURES**

1. Potential conflicts with existing solid waste facilities shall be avoided.  
**Responsible Departments: Public Works, Environmental Resources, Planning, Planning Commission, Board of Supervisors**
2. Sites identified as potential solid waste facilities within an adopted County-wide Integrated Waste Management Plan should be protected to the greatest possible extent from land use conflicts.  
**Responsible Departments: Public Works, Environmental Resources, Planning, Planning Commission, Board of Supervisors**

## **POLICY SIXTEEN**

Outdoor lighting shall be designed to be compatible with other uses.

### **IMPLEMENTATION MEASURES**

1. Develop light and glare standards to ensure that artificial outdoor lighting is efficient and focused on achieving safety and security requirements for the associated land use.  
**Responsible Departments: Planning, Planning Commission, Board of Supervisors**
2. Outdoor lighting shall be required to provide minimum impact to the surrounding environment and where feasible will utilize downcast, cut-off type fixtures that are shielded and direct the light only towards objects requiring illumination.  
**Responsible Departments: Planning, Planning Commission, Board of Supervisors**

### GOAL THREE

Foster stable economic growth through appropriate land use policies.

#### POLICY SEVENTEEN

Agriculture, as the primary industry of the County, shall be promoted and protected.

#### IMPLEMENTATION MEASURES

1. The County shall require a 10-acre minimum parcel size for parcels requesting inclusion in the Williamson Act.  
**Responsible Departments: Planning, Board of Supervisors**
2. As land is designated to accommodate new businesses, the County shall give priority to utilizing less productive agricultural areas.  
**Responsible Departments: Agricultural Commissioner, Planning, Planning Commission, Board of Supervisors**
3. Specific plans shall be encouraged when non-agricultural uses are proposed within areas designated for agriculture.  
**Responsible Departments: Planning, Planning Commission, Board of Supervisors**
4. The County shall continue to implement the Agricultural Element.  
**Responsible Departments: Agricultural Commissioner, Planning, Planning Commission, Board of Supervisors**
5. Where parcels under a Williamson Act contract are divided and result in parcels of less than ten acres, a notice of non-renewal shall be filed for the contract on those parcels. This affects subdivision maps, parcel maps, and lot line adjustments.  
**Responsible Departments: Planning, Planning Commission, Board of Supervisors**

#### POLICY EIGHTEEN

Promote diversification and growth of the local economy.

#### IMPLEMENTATION MEASURES

1. Stanislaus County shall continue to work with economic development entities to promote Stanislaus County as a profitable location for industry.  
**Responsible Department: Chief Executive Office, Planning, Planning Commission, Board of Supervisors**
2. The Board shall support the use of financial mechanisms supporting the introduction and growth of businesses in the County.  
**Responsible Departments: Planning, Board of Supervisors**

3. Continue to implement achievable components of the economic strategies recognized and/or adopted by the Board of Supervisors.  
**Responsible Departments: Planning, Planning Commission, Board of Supervisors**
4. Encourage the development of new industries and the retention of existing industries that help the community reduce, recycle, and/or reuse waste that would otherwise require disposal.  
**Responsible Departments: Environmental Resources, Board of Supervisors**
5. Allow private recreational uses where they are not found to cause land use conflicts.  
**Responsible Departments: Parks and Recreation, Planning, Planning Commission, Board of Supervisors**
6. Emphasize the conservation and development of significant mineral resources as identified in Special Reports prepared by the California Geological Survey, by implementing the policies and implementation measures specified under Goal Nine of the Conservation/Open Space Element.  
**Responsible Departments: Planning, Planning Commission, Board of Supervisors**
7. Strengthen the agricultural sector of the economy by continuing to implement the strategies for agriculture-related economic development identified under Goal One of the Agricultural Element.  
**Responsible Departments: Environmental Resources, U.C. Cooperative Extension, Agricultural Commissioner, Planning, Planning Commission, Board of Supervisors**
8. Encourage tourism in Stanislaus County by continuing to participate in efforts to develop a tourism program, including marketing strategies and objectives.  
**Responsible Departments: Planning, Planning Commission, Board of Supervisors**
9. Encourage reuse of the Crows Landing Air Facility as a regional jobs center.  
**Responsible Departments: Chief Executive Office, Planning, Planning Commission, Board of Supervisors**

## **POLICY NINETEEN**

Accommodate the siting of industries with unique requirements.

### **IMPLEMENTATION MEASURE**

1. The criteria described in the **LAND USE DESIGNATIONS** section of this element shall be applied in the siting of industries with unique requirements.  
**Responsible Departments: Planning, Planning Commission, Board of Supervisors**

## **POLICY TWENTY**

Nonconforming uses are an integral part of the County's economy and, as such, should be allowed to continue.

### **IMPLEMENTATION MEASURE**

1. Maintain current Zoning Ordinance provisions (Chapter 21.80 of the County Code) which permit replacement or expansion of nonconforming uses.  
**Responsible Departments: Planning, Planning Commission, Board of Supervisors**

## **POLICY TWENTY-ONE**

Facilitate retention and expansion of existing businesses.

### **IMPLEMENTATION MEASURES**

1. The County shall support economic development efforts and opportunities of partnership on workforce training activities.  
**Responsible Departments: Chief Executive Office, Planning, Board of Supervisors**
2. The County shall investigate the use of federal and state funds to provide incentives for businesses to locate, expand, or relocate in Stanislaus County.  
**Responsible Departments: Planning, Board of Supervisors**

## **POLICY TWENTY-TWO**

Support and facilitate efforts to develop and promote economic development and job creation centers throughout the County.

### **IMPLEMENTATION MEASURE**

1. While supporting efforts to direct economic development and job creation centers towards incorporated areas, the County shall also consider approval of centers in unincorporated areas of unique character and proximity to transportation infrastructure.  
**Responsible Departments: Chief Executive Office, Planning, Board of Supervisors**

***THIS PAGE INTENTIONALLY LEFT BLANK***

## GOAL FOUR

Ensure that an effective level of public service is provided in unincorporated areas.

### POLICY TWENTY-THREE

At least three net acres of developed neighborhood parks, or the maximum number of acres allowed by law, should be provided for every 1,000 residents, through land dedication and development, payment of in-lieu-of fees, public facility fees, or other methods acceptable to the Parks Department.

### IMPLEMENTATION MEASURE

1. Continue to implement the strategies identified under Goal Four of the Conservation/Open Space Element.  
**Responsible Departments: Parks and Recreation, Parks Commission, Planning, Planning Commission, Chief Executive Office, Board of Supervisors**

### POLICY TWENTY-FOUR

Future growth shall not exceed the capabilities/capacity of the provider of services such as sewer, water, public safety, solid waste management, road systems, schools, health care facilities, etc.

### IMPLEMENTATION MEASURES

1. The County shall continue to implement its Public Facilities Fees Program, which is intended to help finance public facilities needed to maintain current levels of service.  
**Responsible Departments: Public Facilities Fees Committee, Auditor-Controller, Chief Executive Office, Planning, Board of Supervisors**
2. Development within a public water district and/or waste water district shall connect to the public water system and/or the waste water treatment facility; except where capacity is limited or connection to existing infrastructure is limiting and an alternative is approved by the County's Department of Environmental Resources. For development outside a water and/or waste water district, it shall meet the standards of the Stanislaus County Primary and Secondary Sewage Treatment Initiative (Measure X) and domestic water.  
**Responsible Departments: Environmental Resources, Planning, Planning Commission, Board of Supervisors**
3. Benefit assessment districts, County Service Areas (CSA's), Mello-Roos Districts or other similar districts shall be formed as needed to pay for the cost of providing ongoing appropriate services.  
**Responsible Departments: Chief Executive Office, Sheriff, Public Works, Environmental Resources, Fire Warden's Office, Local Fire Agency Having Jurisdiction, Library, Parks and Recreation, Community Services Agency, Treasurer-Tax Collector, Auditor-Controller, Planning, Planning Commission, Board of Supervisors**

4. The County shall continue to work with independent fire districts and health care districts to implement fees to help finance public facilities to support their services.  
**Responsible Departments: Chief Executive Office, Fire Warden's Office, Local Fire Agency Having Jurisdiction, Board of Supervisors**
5. The current level of service of public agencies shall be determined and not allowed to deteriorate as a result of new development.  
**Responsible Departments: Chief Executive Office, Sheriff, Public Works, Environmental Resources, Fire Warden's Office, Local Fire Agency Having Jurisdiction, Library, Parks and Recreation, Community Services Agency, Treasurer-Tax Collector, Auditor-Controller, Planning, Planning Commission, Board of Supervisors**
6. Rezoning of property for development prior to: 1) annexation to a special district; or 2) inclusion of such property into a newly formed special district that will provide urban services (i.e. sanitary sewer district, domestic water district, or community service district) shall be approved only if the development is adequately conditioned to restrict development from occurring until annexation to, or formation of, the required district is complete.  
**Responsible Departments: Planning, Planning Commission, Board of Supervisors**
7. Only development requests which have recognized and mitigated any significant impacts on solid waste reduction, recycling, disposal, reuse, collection, handling, and removal shall be approved.  
**Responsible Departments: Environmental Resources, Planning, Planning Commission, Board of Supervisors**
8. Only development requests which have recognized and reasonably mitigated significant impacts on school facilities shall be approved.  
**Responsible Departments: Planning, Planning Commission, Board of Supervisors**
9. The County will coordinate development with existing irrigation, water, utility, and transportation systems by referring projects to appropriate agencies and organizations for review and comment.  
**Responsible Department: Planning**

## **POLICY TWENTY-FIVE**

New development shall pay its fair share of the cost of cumulative impacts on circulation and transit systems.

## **IMPLEMENTATION MEASURES**

1. Benefit assessment districts or other similar districts shall be formed as needed to pay for the cost of providing ongoing appropriate transportation services.  
**Responsible Departments: Chief Executive Office, Public Works, Treasurer-Tax Collector, Auditor-Controller, Board of Supervisors**
2. Traffic impacts, not covered under Public Facility Fees, shall be identified and impact mitigation fees shall be paid by the subdivider and/or developer.  
**Responsible Departments: Public Works, Planning, Planning Commission, Board of Supervisors**



3. The level of service (LOS) for all roadways and intersections shall be at least a "D" level, unless they are located within the sphere of influence of a city that has adopted a lower level of service.

***Responsible Departments: Public Works, Planning, Planning Commission, Board of Supervisors***

4. Applicants for General Plan amendments shall coordinate with the Stanislaus Council of Governments (StanCOG) Congestion Management Process to mitigate traffic impacts.

***Responsible Departments: Public Works, Planning, Planning Commission, Board of Supervisors***

***THIS PAGE INTENTIONALLY LEFT BLANK***

## GOAL FIVE

Complement the general plans of cities within the County.

### POLICY TWENTY-SIX

Development, other than agricultural uses and churches, which requires discretionary approval and is within the sphere of influence of cities or in areas of specific designation created by agreement (e.g., Sperry Avenue and East Las Palmas Corridors), shall not be approved unless first approved by the city within whose sphere of influence it lies or by the city for which areas of specific designation were agreed. Development requests within the spheres of influence or areas of specific designation of any incorporated city shall not be approved unless the development is consistent with agreements with the cities which are in effect at the time of project consideration. Such development must meet the applicable development standards of the affected city as well as any public facilities fee collection agreement in effect at the time of project consideration. (Comment: This policy refers to those development standards that are transferable, such as street improvement standards, landscaping, or setbacks. It does not always apply to standards that require connection to a sanitary sewer system, for example, as that is not always feasible.)

### IMPLEMENTATION MEASURES

1. All discretionary development proposals within the sphere of influence or areas of specific designation of a city shall be referred to that city to determine whether or not the proposal shall be approved and whether it meets their development standards. If development standards of the city and County conflict; the city's standards shall govern.  
**Responsible Departments: Planning, Planning Commission, Board of Supervisors**
2. The policies described in the section on **SPHERES OF INFLUENCE** for projects within a city's sphere of influence or areas of specific designation shall be followed.  
**Responsible Departments: Planning, Planning Commission, Board of Supervisors**
3. The County shall limit its approval of discretionary projects in spheres of influence to agricultural uses, churches and projects recommended for approval by the city unless such projects are exempt from this implementation measure as a result of individual city/county agreements (e.g., upper McHenry Avenue, Beard Tract areas).  
**Responsible Departments: Planning, Planning Commission, Board of Supervisors**
4. Discretionary projects in areas zoned other than A-2 (General Agriculture) prior to the applicable agreement with the city within whose sphere of influence the project lies shall not be allowed to develop consistent with the current zone classification unless they first obtain approval for the project from the city.  
**Responsible Departments: Planning, Planning Commission, Board of Supervisors**
5. Non-discretionary projects in spheres of influence shall be allowed to develop with existing entitlements. However, the County shall coordinate with the cities to identify opportunities to develop uniform development standards.  
**Responsible Departments: Public Works, Planning**

6. The County shall amend its ordinances as necessary to implement any specific designation created by agreement. All active agreements shall be incorporated into the General Plan as an Appendix to the Land Use Element and upon approval may be incorporated into the General Plan without the need for a General Plan amendment.

***Responsible Departments: Planning, Planning Commission, Board of Supervisors***

## **POLICY TWENTY-SEVEN**

Development which requires discretionary approval and is outside the sphere of influence of cities, but located within one mile of a city's adopted sphere of influence, and within a city's adopted general plan area, shall be referred out to the city for consideration. However, the County reserves the right for final discretionary action.

### **IMPLEMENTATION MEASURES**

1. All discretionary development proposals within one mile of a city's adopted sphere of influence boundary and within a city's adopted general plan area, shall be referred to that city.

***Responsible Departments: Planning, Planning Commission, Board of Supervisors***

2. The County shall consider applying city development standards to discretionary projects located within one mile of a city's adopted sphere of influence boundary and within the city's adopted general plan area to the extent such standards are appropriate for the type of development.

***Responsible Departments: Public Works, Environmental Resources, Planning, Planning Commission, Board of Supervisors***

3. Encourage joint County and city cooperation in establishing land use and development standards along all major County defined gateways to cities.

***Responsible Departments: Public Works, Planning, Planning Commission, Board of Supervisors***

## **POLICY TWENTY-EIGHT**

The County shall support a County-wide growth management strategy that is equitable to the needs of the County and all nine cities, taking into consideration land consumption and absorption rates.

### **IMPLEMENTATION MEASURES**

1. The County shall participate in efforts to develop and implement a County-wide growth management strategy that is consistent with the County General Plan.

***Responsible Departments: Planning, Planning Commission, Board of Supervisors***

2. The County shall encourage LAFCO to consider land consumption and absorption rates when evaluating the size of sphere of influence and annexation proposals in order to determine that the proposal does not exceed what is reasonably needed to accommodate the amount and type of development anticipated to occur.

***Responsible Departments: Planning, Planning Commission, Board of Supervisors***

## GOAL SIX

### Promote and protect healthy living environments

#### POLICY TWENTY-NINE

Support the development of a built environment that is responsive to decreasing air and water pollution, reducing the consumption of natural resources and energy, increasing the reliability of local water supplies, and reduces vehicle miles traveled by facilitating alternative modes of transportation, and promoting active living (integration of physical activities, such as biking and walking, into everyday routines) opportunities.

#### IMPLEMENTATION MEASURES

1. County development standards shall be evaluated and revised, as necessary, to facilitate development incorporating the following (or similar) design features:
  - Alternative modes of transportation such as bicycle lanes, pedestrian paths, and facilities for public transit;
  - Alternative modes of storm water management (that mimic the functions of nature); and
  - Pedestrian friendly environments through appropriate setback, landscape, and wall/fencing standards.

***Responsible Departments: Public Works, Planning, Planning Commission, Board of Supervisors***

#### POLICY THIRTY

New development shall be designed to facilitate the efficient extension of public transportation systems.

#### IMPLEMENTATION MEASURES

1. Development proposals shall be referred to the appropriate transit authority to determine the types of facilities needing to be provided, if any.

***Responsible Departments: Public Works, Planning, Planning Commission, Board of Supervisors***

#### POLICY THIRTY-ONE

The County shall support efforts to improve local health care options through the siting of new facilities in locations with the infrastructure (including, but not limited to, transportation and utility) to support both facility and client needs.

***Responsible Departments: Planning, Planning Commission, Board of Supervisors***

***THIS PAGE INTENTIONALLY LEFT BLANK***

## **GOAL SEVEN**

Provide for direct citizen participation in land use decisions involving the expansion of residential uses into agricultural and open-space areas in order to encourage compact urban form and to preserve agricultural land.

### **POLICY THIRTY-TWO**

- A. Any decision by the Board of Supervisors of the County of Stanislaus to approve the redesignation or rezoning of land from an agricultural or open space use to a residential use shall require, and be contingent upon, approval by a majority vote of the County voters at a general or special local election. In the event the Board approves the redesignation or rezoning of such land for a residential use, such approval shall not take effect unless and until that decision is approved by an affirmative majority vote of the voters of the County voting on the proposal.
- B. The requirement set forth in paragraph (A) shall apply to all such decisions affecting land that is designated for agricultural or open space use on the Land Use Map of the County's General Plan as of the effective date of this policy, even if the affected land is, after the effective date, redesignated or rezoned to a use other than an agricultural or open space use. The intent of this paragraph is to ensure that a developer does not launder land by obtaining County approval for a non-residential use (e.g., an industrial or commercial use), and then subsequently obtain County approval for a residential use.
- C. The Board's decision to approve the redesignation or rezoning of land from an agricultural or open space use to a residential use constitutes the approval of a project for purposes of CEQA. For this reason, the County shall comply with CEQA prior to the Board's decision to approve the redesignation or rezoning, notwithstanding the requirement that the voters approve such redesignation or rezoning.
- D. Once the voters have approved a land use map designation or land use entitlement for a property, additional voter approval shall not be required for: (1) subsequent entitlement requests that are consistent with the overall approved development project or land use designation and zoning; and (2) any requested modification to a land use or zoning designation that does not decrease the number of permitted dwellings, as specified in the exhibits and plans approved by the voters.
- E. Exemptions. The requirement for voter approval set forth in this policy shall not apply to any of the following:

1. After notice and hearing as required by state law and after compliance with CEQA, the Board of Supervisors may, without a vote of the electorate of the County, approve residential development on land designated for agricultural or open space uses if the Board finds, based on substantial evidence in the record, and HCD certifies in writing, that all of the following circumstances exist: (a) the approval is necessary and required to meet the County's legal fair share housing requirement; and (b) there is no other land in the County or the cities in the County already designated for urban use that can accommodate the County's legal fair share housing requirement. The Board shall not redesignate more than ten (10) acres per year for residential use under this paragraph.
2. Additional acreage may be designated for residential use if the Board finds, and HCD certifies in writing, that the additional acreage is necessary to meet the Board's legal fair share obligation based on maximum multi-family densities. Any proposal approved under this subsection shall be required to have all housing units permanently affordable to persons or families of moderate, low and very low income. The intent of this exemption is to provide sufficient land for housing to accommodate moderate, low and very low income housing, as may be necessary over time under state law.
3. Any development project that has obtained a vested right pursuant to state law prior to the effective date of this policy.
4. Any development project consisting entirely of farm worker housing.

F. Definitions.

The following definitions apply to this policy:

1. Residential use means any land use designation, zoning district or other legislative entitlement authorizing, allowing, or consistent with residential development at a density greater than one (1) dwelling unit per ten (10) gross acres. Such density shall not include (a) caretaker housing or other residential uses incidental to the primary use, or (b) farm worker housing. Residential use includes the following land use designations set forth in the General Plan (1994), all land use designations that may be adopted by the County in the future that are comparable to such designations, and all zoning districts compatible with such designations: Estate Residential, Low-Density Residential, Medium-Density Residential, Medium High-Density Residential, Planned Development, and Specific Plan.
2. Agricultural or open space use means any land use designation or zoning district authorizing, allowing, or consistent with residential development at a density of equal to or less than one (1) dwelling unit per ten (10) gross acres. Agricultural or open space use includes the following land use designations set forth in the General Plan (1994), all land use designations that may be adopted by the County in the future that are comparable to such designations, and all zoning districts compatible with such designations: Agriculture, Urban Transition, Mineral Resources.
3. General Plan means the Stanislaus County General Plan adopted in or about October 1994, as amended through the effective date.
4. Effective date means the effective date of the Citizen's Right to Vote on Expansion of Residential Areas initiative measure, as established by the California Elections Code.



5. Board or Board of Supervisors means the Stanislaus County Board of Supervisors.
  6. County means Stanislaus County.
  7. CEQA means the California Environmental Quality Act.
  8. HCD means the California Department of Housing and Community Development.
- G. Duration; Amendment. Goal Seven and Policy Thirty-two, shall remain in effect until December 31, 2036, and may be amended or repealed only by the voters of the County at an election held in accordance with state law.

***THIS PAGE INTENTIONALLY LEFT BLANK***

## **SPHERES OF INFLUENCE**

### **BACKGROUND**

In 1973, Stanislaus County adopted a new General Plan concept called Urban Transition. This designation was placed on property outside the city limits but within the city's general plan boundary. One of the reasons for development of this designation was ongoing conflicts between the County and the cities. The County routinely approved development of land within a city's general plan boundary without regard to consistency with the city's plans. This caused a variety of problems for a city. First, although rare, development sometimes occurred which was not acceptable to the city, therefore, no attempt was made to annex the property resulting in islands of unincorporated areas within a city. Second, if the County permitted urban development within the County, there was no incentive for the property owner to annex. This often prevented annexation. Third, even if the city wanted to annex the property and the property owner agreed, the development seldom met city standards with respect to street improvements, landscaping, signage, etc. At this point, there was no recourse for the city to upgrade the requirements.

With the adoption of the Urban Transition designation, development in most instances was required to annex before approval. Development which was allowed by ordinance without annexation was referred to the appropriate city for comment. The intent of the referral was to gain city input on whether or not a proposal was consistent with the city's plans and, if so, did the proposed development standards equal what the city would require if development were to occur in the city.

Originally, referrals were only made if the General Plan designation was Urban Transition although the Urban Transition area is only a portion of the area within a city's general plan boundary. Gradually, referrals were made of all applications within a city's general plan boundary regardless of whether or not the property was designated Urban Transition.

In late 1984, the Local Agency Formation Commission (LAFCO) adopted spheres of influence for each city and special district as required by state law. These spheres are "a plan for the probable physical boundaries and service area of a local agency, as determined by the commission." (California Government Code Section 56076)

While the Urban Transition designation remains, the practice of re-designating land to Urban Transition has not continued; with the exception of community plan areas for unincorporated communities. Instead, the County has adopted the Sphere of Influence policy below to address discretionary development within adopted spheres of influence. The policy is reflected as Policy Twenty-six of this element and, in accordance with the policy, all development proposals within an adopted sphere of influence are referred to the appropriate city for comment.

Additionally, in instances where a city's general plan boundary encompasses areas beyond that of an adopted sphere of influence, as reflected in Policy Twenty-seven of this element, development which is located within one mile of a city's adopted sphere of influence and within a city's adopted general plan area is also referred to a city for consideration. However, in these cases the County reserves the right for final discretionary action.

## **POLICY**

Whenever an application is to be considered which includes property within the sphere of influence of a city or special district (e.g., sewer, water, community services) or areas of specific designation created by agreement between County and City, the following procedures should be followed:

1. Development, other than agricultural uses and churches, which requires discretionary approval shall be referred to that city for preliminary approval. The project shall not be approved by the County unless written communication is received from the city memorializing their approval. If approved by the city, the city should specify what conditions are necessary to ensure that development will comply with city development standards. Requested conditions for such things as sewer service in an area where none is available shall not be imposed. Approval from a city does not preclude the County decision-making body from exercising discretion, and it may either approve or deny the project.
2. Agricultural uses and churches which require discretionary approval should be referred to that city for comment. The County Planning Commission and Board of Supervisors shall consider the responses of the cities in the permit process. If the County finds that a project is inconsistent with the city's general plan designation, it shall not be approved. Agricultural use and churches shall not be considered inconsistent if the only inconsistency is with a statement that a development within the urban transition area or sphere of influence shall be discouraged (or similar sweeping statement). The city shall be asked to respond to the following questions:
  - A. Is the proposed project inconsistent<sup>1</sup> with the land use designation on the city's general plan? If so, please include a copy of the map (or that portion which includes the subject property) and the text describing uses permitted for the general plan designation. All findings of inconsistency must include supporting documentation.
  - B. If the project is approved, specifically what type of conditions would be necessary to ensure the development will comply with city development standards such as street improvements, setbacks and landscaping?

In the case of a proposed project within the sphere of influence of a sanitary sewer district, domestic water district, or community services district, the proposal shall be forwarded to the district board for comment regarding the ability of the district to provide services. If the district serves an unincorporated community with a Municipal Advisory Council (MAC), the proposal shall also be referred to the MAC for comment.

---

<sup>1</sup>The question is specifically phrased to ask if a proposed project is inconsistent with the General Plan designation. This is intended to (a) encourage a city to specifically designate all land within its Sphere of Influence if it wants to oppose development proposals within the Sphere, and (b) to assure that tangible proof is submitted if denial is requested. This will eliminate the County's dilemma of trying to prove something is consistent with an inadequate General Plan.

## LAND USE DESIGNATIONS

The following land use designations shall be used in the unincorporated area of the County. They are intended to further the Land Use Element goals and policies. If any of these designations fall within the sphere of influence of a sanitary sewer district, domestic water district, or community services district that provides services to an unincorporated community, it will be necessary to consult the **COMMUNITY PLANS** section to determine if any modification of the designation applies. For areas within such a sphere of influence, the community plans indicate the proposed future General Plan land use designations.

State of California requirements for the Land Use Element state the General Plan should designate general distribution and location of land for various kinds of uses. Most of these, such as housing, industry and agriculture, are identifiable by the obvious nature of their specific land use designations. There are; however, certain kinds of uses which are not so obvious. These uses are education, public buildings and grounds, and solid and liquid waste disposal facilities. In addition, the Land Use Element must identify areas that are subject to flooding. Information follows regarding specific land uses and areas which are subject to flooding.

### **ESTATE RESIDENTIAL**

**Intent.** The intent of the Estate Residential designation is to satisfy the desires of people who wish to live on a relatively small parcel in a rural setting and are willing to accept less than the full range of urban services. It should be applied only to land which is beyond the projected ultimate (or 20-year) service area of a city or special district which provides urban services and which is outside the adopted sphere of influence for a community.

**Zoning.** The R-A (Rural Residential) zone is appropriate within this designation. PD (Planned Development) zoning may also be appropriate provided the development does not exceed the established building intensity of this designation. Building intensity normally is zero to one dwelling unit per three acres. Building intensity may increase to two dwellings as allowed by zoning regulations. Population density averages approximately one to two persons per acre.

**Appropriate Locations.** The Estate Residential designation is appropriate in areas beyond the sphere of influence of a city (or special district which provides urban services) which is a less productive agricultural area but capable of supporting rural residential development. Among the factors to be considered in making this determination are: (1) existing and potential agricultural suitability (availability of irrigation facilities, crop history and potential); (2) surrounding land use (impacts caused by possible intrusion of rural residential uses and non-agricultural uses); (3) septic tank suitability (Environmental Resources standards for minimum area requirements and potential impacts of a concentration of septic tanks); (4) surrounding parcel size (conformity to adjacent parcel sizes); (5) soil type (soil grade and Storie rating); (6) public road access (length of necessary accesses, condition of existing public roads and future plans for both public roads and private access roads as determined by the Department of Public Works); (7) aesthetic characteristics (removal of natural vegetation, impairment of scenic view, introduction of uses or structures not in the same character as the surrounding area); and (8) anticipated environmental impact (removal of habitat of rare or endangered plant or animal, removal of riparian areas and impacts on natural resources).

## **LOW-DENSITY RESIDENTIAL**

**Intent.** The intent of this designation is to provide appropriate locations and adequate areas for single-family detached homes in either conventional or clustered configurations. Single-family detached dwellings are the predominant housing type in areas so designated, and would remain so under this designation. Semi-detached dwellings and manufactured housing would be consistent with this designation.

**Zoning.** R-A (Rural Residential), R-1 (Single-Family Residential), SCP-R-1-ST (Salida Community Plan, Single-Family Residential Special Treatment Zone) and SCP-R-1 (Salida Community Plan, Single-Family Residential) zones are appropriate within this designation. Planned Development (PD) zoning may also be appropriate, provided the development does not exceed the established building intensity of this designation. The use of the US Urban Service (US) combining district in conjunction with any of the above zones would be appropriate for areas adjacent to unincorporated communities so that annexation to and service from the adjoining sanitary sewer district or community services district is required prior to development. Residential building intensity when served by a community services district or sanitary sewer district and public water district is zero to eight units per net acre. Building intensity for areas not served by public water and sewer service is zero to two units per net acre. Population density ranges from zero to 25 persons per net acre in areas served by public water and sewer and zero to six persons per net acre in other areas. Small second units, as permitted by state law, may increase both the building intensity and the population density to a limited degree within this designation.

**Appropriate Locations.** The Low-Density Residential designation is appropriate in established residential areas characterized by single-family dwellings. It would also be appropriate in areas: (a) designated by the Board of Supervisors for ranchettes of 1/2 to one acre in size if the area is a less productive agricultural area but capable of supporting rural residential development based on the eight factors to be considered in locating "Estate Residential" land; or (b) adjacent to unincorporated communities which can serve the development after annexation to and service by a sanitary district or community services district.

## **MEDIUM-DENSITY RESIDENTIAL**

**Intent.** The intent of this designation is to provide appropriate locations for single- and multi-family units, primarily in semi-detached or clustered arrangements. Typical housing types would be single-family detached manufactured houses, duplexes, triplexes and low-mass multi-family units (townhouses and garden apartments).

All lands within this designation shall be within the boundaries of a community services district, sanitary district or similar public district which provides US except where such designation existed at the time of adoption of this plan.

**Zoning.** The R-2 (Medium-Density Residential) and SCP-R-2 (Salida Community Plan, Medium Density Residential) zones are appropriate within this designation. PD (Planned Development) zoning may also be appropriate provided the development does not exceed the established building intensity of this designation. PD zoning which allows sewage generated on site to be metered into the disposal system during non-peak hours is encouraged in communities with limited system capacity. Residential building intensity varies from zero up to 14 units per net acre. Population density ranges from zero to 45 persons per net acre.

**Appropriate Locations.** The Medium-Density Residential designation would be appropriate in areas adjacent to unincorporated communities where the Board of Supervisors has determined, pursuant to a community plan, that medium-density residential use is needed. These areas will be developed only after annexation to and service by a sanitary district or community services district.

### **MEDIUM HIGH-DENSITY RESIDENTIAL**

**Intent.** The intent of this designation is to provide appropriate locations for housing types including duplexes, triplexes, fourplexes, and apartment buildings. This designation shall be within the boundaries of a community services district, sanitary district or similar public district which provides urban services.

**Zoning.** The R-3 (Multiple-Family Residential) and SCP-R-3 (Salida Community Plan, Multiple Family Residential) zones are appropriate within this designation. PD (Planned Development) zoning may also be appropriate provided the development does not exceed the established building intensity of this designation. PD zoning which allows sewage generated on site to be metered into the disposal system during non-peak hours is encouraged in communities with limited system capacity. Residential building intensity varies from zero to 25 units per net acre. Population density ranges from zero to 85 persons per net acre.

**Appropriate Locations.** The Medium High-Density Residential designation is appropriate in established residential areas characterized by duplexes, triplexes, fourplexes, and apartment buildings. It would also be appropriate in areas adjacent to unincorporated communities where the Board of Supervisors has determined, pursuant to a community plan, that medium high-density residential use is needed. These areas will be developed only after annexation to and service by a sanitary district or community services district.

### **COMMERCIAL**

**Intent.** The intent of this designation is to indicate areas best suited for various forms of light to heavy commercial uses, including retail, service, and wholesaling operations. This designation also allows for residential development in limited situations or when connected to both public sewer and water service. The County has one designation to correspond to the various commercial zoning districts. This designation is intended for lands which demonstrate a valid supportive relationship to other existing or projected urban development.

**Zoning.** C-1 (Neighborhood Commercial), C-2 (General Commercial), H-1 (Highway Frontage Commercial), SCP-C-1 (Salida Community Plan, Neighborhood Commercial) and SCP-C-2 (Salida Community Plan, General Commercial) zones shall be considered consistent with this designation. PD (Planned Development) zoning may also be appropriate provided the development does not exceed the established building intensity of this designation. The building intensity shall be determined by Zoning Ordinance development standards for setback, landscaping, height, parking and other requirements except that residential building intensity shall not exceed 25 units per net acre. In no case shall buildings exceed 75 feet in height, nor shall they cover so much of the lot that insufficient area remains for parking, landscaping, etc. In commercial zones which allow dwelling units, population density can range from zero to 85 persons per net acre.

**Appropriate Locations.** The Commercial designation is appropriate in areas already committed to commercial use. In unincorporated communities this designation is appropriate for Central Business Districts and other areas within the sanitary sewer or community services district in sufficient amount to serve the needs of the community. Areas adjacent to community services district may also be

appropriate if the US (Urban Service) combining zone is utilized. This designation shall allow uses that are deemed compatible with adjacent development through the use of discretionary permits.

## **INDUSTRIAL**

**Intent.** The intent of this designation is to indicate areas for various forms of light or heavy industrial uses, including, but not limited to, manufacturing and warehousing. Generally, the Industrial designation shall be used in areas where public sewer and water are available or where the restrictions of the Planned Industrial designation are inappropriate. The Planned Industrial designation shall be used instead of the Industrial designation unless (a) the property to be designated is intended for a single-use applicant not permitted in the Planned Industrial designation and the applicant needs a very large site (see discussion under **Designating New Industrial Areas** or (b) the property is adjacent to an existing industrial area which is reaching capacity and whose services can be extended to serve the expansion.

**Zoning.** The LM (Limited Industrial), M (Industrial) and PI (Planned Industrial) zones shall be consistent with this designation. PD (Planned Development) zoning may also be appropriate provided the development does not exceed the established building intensity of this designation. Building intensity is governed by the fact that the Zoning Ordinance prohibits more than 75% coverage of the property by buildings. Buildings for human occupancy shall not exceed 75 feet in height. Population density is almost nonexistent as only one residential unit per parcel is allowed and then only if it is secondary to the industrial use of the property.

**Designating New Industrial Areas.** The criteria listed below shall be used in evaluating potential areas, both for general Industrial designation and for designating sites for industries that need very large sites. There are few industries with the need for extremely large parcels, but they do exist. It is not practical to designate a large industrial area because a large amount of land might lay idle for an extended period of time. If an industry requiring a large site approaches the County or if more industrial sites are needed, the following criteria shall be used in determining whether or not a site is suitable for being designated Industrial:

- a. **Access.** The proposed site should have adequate access to handle the type and quantity of traffic associated with industrial uses without impacting existing facilities. This shall usually mean that the area will be located on a major road at a minimum, with location on a state highway preferred.
- b. **Sewage disposal.** Public sanitary sewer service should be available and a written commitment for service received. (Lands suitable for industrial development but without public sanitary sewer service should more appropriately be designated Planned Industrial.)
- c. **Water.** An adequate supply of potable water should be available for industrial usage including water needed for fire suppression. Generally this will require a public water supply in order to meet fire flow standards.
- d. **Infrastructure.** Other utilities (such as natural gas, electricity) shall be reasonably available to the site as might be required by the proposed uses.
- e. **Topography.** The site is physically suitable for industrial development.



- f. **Williamson Act and other constraints to development.** The site should be free from constraints such as valid Williamson Act Contracts that would inhibit rezoning and development of the area.
- g. **Conflicts.** The proposed site development shall not cause land use conflicts with surrounding properties. From this viewpoint, expansion of existing areas is more desirable than designating totally new areas.
- h. **City general plan land use designation.** Any new areas proposed for Industrial designation shall be consistent with the general plan of any city in whose sphere of influence they lie.
- i. **Countywide Integrated Waste Management Plan.** Any new areas proposed for Industrial designation shall be consistent with the Countywide Integrated Waste Management Plan.

### **PLANNED INDUSTRIAL**

**Intent.** The intent of this designation is to provide locations for light industrial development. Such locations may be so designated on the initiative of the County or may be requested by a property owner or group of property owners. The Planned Industrial designation shall be preferred to the Industrial designation as it allows more control of development to ensure that impacts on adjoining properties are reduced. It shall be used largely in areas without public sewer and/or water service but shall only be used if it is practical, both physically and financially, to provide sewage disposal and water service as needed by the proposed development.

**Zoning.** Building intensity will be determined by the County on an individual basis, depending upon the nature and location of the proposed planned development. However, no buildings shall cumulatively occupy more than 70% of the area of any parcel. Population density is almost nonexistent as only one residential unit per parcel is allowed if it is secondary to the industrial use of the property. The A-2 (General Agriculture), PI (Planned Industrial), LI (Light Industrial), IBP (Industrial Business Park), SCP-PI (Salida Community Plan, Planned Industrial) and all industrial or business park related PD (Planned Development) zones shall be consistent with this designation.

**Appropriate Locations.** Appropriate locations for the Planned Industrial designation shall be based on the same criteria as used for designating new industrial areas. The Planned Industrial designation shall be more appropriate than Industrial in locations with limited or no sanitary sewer capacity or in other locations where restricting the permitted uses is desirable.

### **INDUSTRIAL TRANSITION**

**Intent.** This designation is intended for lands within spheres of influence which for the most part are not zoned or developed for industrial usage, but lie in the path of a valid expansion of a contiguous industrial area. Land falling within this designation may continue to be zoned and used for non-industrial purposes pending demand for such industrial expansion. Rezoning for industrial usage should not be approved for less than an entire block or an area adjacent to an existing industrial zone and must be based on evidence of industrial development capability and a program for adequate relocation of any persons to be ultimately displaced.

**Zoning.** Property within this designation shall retain its present zoning until such time as conversion to Industrial is desirable. At such time as a General Plan amendment to Industrial is processed,

property will then be rezoned to be consistent with the Industrial General Plan designation. Population density and building intensity within the Industrial Transition areas shall correspond to that of the General Plan designation which most closely matches the zoning of the property in question.

**Appropriate Locations.** The Industrial Transition designation is appropriate in areas within the sphere of influence of a city or within the planning boundary of an unincorporated community which lie in the path of an expanding industrial area.

## **BUSINESS PARK**

**Intent.** The intent of this designation is to accommodate development of modern, employment-intensive uses within the Salida Community Plan. Principal development and employment-generating uses allowed within this designation are characterized by research, product development, professional office, commercial, and business services. A full range of other uses may be permitted within the Business Park designation in conformance with the trends of successful contemporary business parks in Northern California.

**Zoning.** The SCP-IBP (Salida Community Plan, Industrial Business Park) and PD (Planned Development) zones shall be consistent with this designation.

**Appropriate Locations.** Appropriate location for the Business Park designation is within the Salida Community Plan Amendment Area.

## **AGRICULTURE**

**Intent.** The major portion of Stanislaus County is productive and potentially productive agricultural land. These lands are of economic importance not only to Stanislaus County, but to the state and nation as well, as evidenced by the fact that Stanislaus County ranks very high nationally in production of agricultural commodities.

This designation recognizes the value and importance of agriculture by acting to preclude incompatible urban development within agricultural areas. It is intended for areas of land which are presently or potentially desirable for agricultural usage. These are typically areas which possess characteristics with respect to location, topography, parcel size, soil classification, water availability and adjacent usage which, in proper combination, provide a favorable agricultural environment. This designation establishes agriculture as the primary use in land so designated, but allows dwelling units, limited agriculturally related commercial services, agriculturally related light industrial uses, and other uses which by their unique nature are not compatible with urban uses, provided they do not conflict with the primary use. The Agriculture designation is also consistent with areas the overall General Plan has identified as suitable for open space or recreational use and for ranchettes.

**Zoning.** This designation is consistent with an A-2 (General Agriculture) zoning district. PD (Planned Development) zoning may also be appropriate, provided the development does not exceed the established building intensity of this designation. Residential building intensity normally ranges from zero to two dwellings per 40 acres in the A-2-40 zone and up to one dwelling per three acres in A-2-3. Building intensity may increase to two dwellings per three acres for properties with temporary mobile homes as allowed by zoning regulations. Appropriate intensities would correspond for any land zoned A-2-5, A-2-10, A-2-20, A-2-160 or any other agricultural zoning designation. Building intensity for agricultural buildings is virtually unlimited, provided setbacks as listed in the A-2 zoning

district are maintained. Based on a 2010 countywide census figure of 3.08 persons per unit, population density is low and only slightly more than one person per acre even in the A-2-3 zone, and much lower than that in A-2-10 or A-2-40 zones. A Planned Development (PD) zone may also be consistent with this designation when it is used for agriculturally-related uses or for uses of a demonstrably unique character, which due to specific agricultural needs or to their transportation needs or to needs that can only be satisfied in the Agriculture designation, may be properly located within areas designated as agricultural on the General Plan. Such uses can include, facilities for packing fresh fruit, facilities for the processing of agricultural commodities utilized in the County's agriculture community, etc.

**Appropriate Locations.** The Agriculture designation is appropriate in areas where the agricultural land is productive or potentially productive. It is also appropriate in these areas as suitable for open space, recreation uses or ranchette uses such as the Valley Home, Orange Blossom, South Ceres, South Turlock, and Oakdale/Riverbank areas.

### **URBAN TRANSITION**

**Intent.** The purpose of the Urban Transition designation is to ensure that land remains in agricultural usage until urban development consistent with a city's (or unincorporated community's) general plan designation is approved. Generally, urban development will only occur upon annexation to a city, but such development may be appropriate prior to annexation provided the development is not inconsistent with the land use designation of the general plan of the affected city. If this is to occur, a change in the General Plan designation consistent with the adopted goals and policies to some other land use designation shall be required.

**Zoning.** Until Urban Transition lands within a sphere of influence are annexed, they should be zoned General Agriculture (A-2). PD (Planned Development) zoning may also be appropriate, provided the development does not exceed the established building intensity for this designation. Building intensity and population density will be the same as under the Agriculture designation.

**Appropriate Locations.** The Urban Transition designation is appropriate for undeveloped land located within the LAFCO-established sphere of influence of a city or within the planning boundary of an unincorporated community.

### **PLANNED DEVELOPMENT**

**Intent.** The Planned Development designation is intended for land which, because of demonstrably unique characteristics, may be suitable for a variety of uses without detrimental effects on other property.

**Zoning.** Land within a Planned Development designation should be zoned A-2 (General Agriculture) until development occurs through Planned Development zoning. A PD (Planned Development) zone (which, with the A-2 zone, are the only zoning districts consistent with this designation) is applied through application and submission of specific development plans. Building intensity and population density would be determined by the County on an individual basis, depending upon the nature and location of the proposed planned development.

**Appropriate Locations.** The Zoning Ordinance indicates that all applications for planned development should be consistent with the General Plan. The following are considered to be valid uses of the Planned Development designation consistent with the intent of this element:

- a. Application for uses of unique character (not otherwise allowed as proposed in other zoning districts) for which findings can be made as to the appropriateness of the location and the absence of detrimental effect to the surrounding area.
- b. Applications falling within an area designated by this element as a Planned Development area, subject to those resolutions within the appendix of this element that define special policy for planned development uses in the following areas:
  - (1) Upper McHenry Avenue, Resolution No. 87-01 (See Appendix I-C).
  - (2) Freeway Interchange and Frontage Roads adjacent to major highways and freeways, Resolution No. 87-03 (See Appendix I-C).

**HIGHWAY COMMERCIAL PLANNED DEVELOPMENT**

**Intent.** This designation is intended for land located at freeway interchanges where it is necessary to provide services to highway travelers.

**Zoning.** Land within this designation shall be zoned for General Agriculture (A-2) until rezoned to Planned Development (PD). Population density and building intensity will be determined on a case-by-case basis.

Uses within this designation shall be limited to the following as principle uses:

- Truck Stops
- Restaurants
- Motels
- Service Stations
- Overnight R.V. Camping
- Fruit Stands

The following uses may be permitted, but only when accessory to the uses listed above:

- Towing Service
- Minor Emergency Automobile Repair
- Convenience Market
- Wine Tasting

**Appropriate Locations.** The Highway Commercial Planned Development designation is appropriate only for parcels adjacent to a freeway interchange. No property shall be designated Highway Commercial Planned Development and rezoned PD unless findings are made that the change will not be detrimental to the agricultural productivity of the surrounding property and that the subject property is not considered to be one of the County's most productive agricultural areas.

**HISTORICAL**

**Intent.** The Historical designation is intended to preserve areas of local, regional, state or national historical significance. Historical areas should be protected by zoning controls emphasizing the need for new development (or rehabilitation) to be compatible with the historic nature of the area. When a community plan has been adopted for a designated historic area, guidelines for development shall be followed as established within that plan. Development standards which are

applicable elsewhere should be waived if such waiver is consistent with the intent of the Historical designation and does not endanger the public health, safety or welfare.

**Zoning.** This designation shall be considered to be consistent with the County H-S (Historical Site) zoning district. Due to the unique nature of this kind of designation, population density and building intensity for any new projects must be reviewed on an individual basis. For residential uses, however, building intensity should normally be from one to eight units per net acre with a population density of two to 25 persons per net acre. For other uses, building intensity should be determined by the County on an individual basis, depending upon the nature and location of the proposed use.

**Appropriate Locations.** The Historical designation is intended for areas which are of local, regional, state or national historical significance.

## **MINERAL RESOURCES**

**Background.** The State of California has established a classification of mineral resources in Stanislaus County as required by the Surface Mining and Reclamation Act of 1975 (SMARA). The classification is a detailed inventory of known and/or presumed locations of a wide variety of mineral resources throughout Stanislaus County.

The SMARA classification process is designed to implement the basic intent of the State Legislature to create and maintain an effective surface mining and reclamation policy with regulation of surface mining operations to ensure that:

1. Adverse environmental effects are prevented or minimized and mined lands are reclaimed to a usable condition that is readily adaptable for alternative land use.
2. The production and conservation of minerals are encouraged, while giving consideration to values relating to recreation, watershed, wildlife, range and forage, and aesthetic enjoyment.
3. Residual hazards to public health and safety are eliminated (Public Resources Code, Sec. 2712).

SMARA mandates that the County as Lead Agency must amend its General Plan to recognize the mineral information classified by the State assist in the management of land uses that affect areas of statewide and regional significance, and emphasize the conservation and development of identified mineral deposits.

The State's findings are published in Special Reports prepared by the California Geological Survey. The classification maps and mineral information contained in the reports are incorporated in this General Plan by reference, together with Public Resources Code Section 2710 et seq. (SMARA) and state policy.

As indicated in the State's inventory, key minerals commercially excavated in Stanislaus County are construction aggregates, primarily sand and gravel. Significant aggregate areas are shown on the General Plan maps entitled "Aggregate Resource Areas," which are based on more detailed maps provided by the State Division of Mines and Geology. To a large extent, aggregate areas are located in flood plains of rivers and streams, particularly the Tuolumne and Stanislaus Rivers and Orestimba Creek.

These significant aggregate resource areas are protected by the Mineral Resources plan designation, coupled with policies and implementation measures under Goal Nine in the Conservation/Open Space Element that emphasize their conservation and development. County zoning regulations (Chapter 21.88) also regulate surface mining permits and reclamation plans in a manner consistent with the intent and requirements of SMARA.

**Intent.** The Mineral Resources designation is an overlay designation intended to protect mineral deposits that have been identified by the State as being of regional or statewide significance. Development of land designated Mineral Resources will be restricted to those kinds of development that will not interfere with the ultimate excavation of the minerals identified by the State as being in the area.

**Zoning.** Land with this overlay designation shall be zoned for General Agriculture (A-2) or a Planned Development (PD) that is consistent with the underlying designation (Agriculture) and will not interfere with the ultimate excavation of the minerals from the area. Building intensities and population densities shall be consistent with those specified for the Agriculture designation. Surface mining permits and reclamation plans shall meet the requirements established in Chapter 21.88 of the Zoning Ordinance.

**Appropriate Locations.** The Mineral Resources designation shall be located where the State Division of Mines and Geology has designated land as having a mineral deposit of statewide or regional significance. It also may be located in those areas identified as containing significant deposits but which have not been formally designated by the State.

## **SPECIFIC PLAN**

**Intent.** A specific plan is a detailed plan for a specific area of the County. It is guided by and must conform to the General Plan, but its scale permits a relatively detailed level of examination and planning not normally possible in the General Plan.

A specific plan is appropriate where major new development or redevelopment is envisioned as spelled out in the Stanislaus County Specific Plan Guidelines. This designation may serve as either an overlay to other General Plan designations, or in the case of more complex and/or larger projects, it may stand as a separate designation.

**Zoning.** Land designated Specific Plan shall be zoned S-P (Specific Plan) for development under an approved specific plan, or the S-P zone may be an overlay zone used in conjunction with other zoning designations. Population density and building intensity standards for different portions of the S-P zone shall be determined by the specific plan approved by the County, as determined on an individual case basis, except where it is used as an overlay, in which case density and intensity shall not exceed that allowed in the underlying designations.

**Appropriate Locations.** The Specific Plan designation is to be used for areas where it is anticipated that a specific plan will be adopted immediately following the General Plan redesignation. The Specific Plan designation is appropriate for areas which exhibit the following characteristics:

1. Rapidly urbanizing areas with significant new demand for public facilities and services; such a site should be at least 100 acres.
2. Unique physical conditions (including unusual natural resources to be conserved).

3. Complex mixture of uses proposed.
4. Multiple ownership in complex developing area.
5. Need to revitalize a marginal or deteriorated area.
6. Large industrial and/or commercial complexes.
7. Very large single-ownership land developments where a significant new community is to be developed in a presently non-urban area.
8. Special study areas.

The Director of Planning and Community Development shall determine when a given project will require that a specific plan be prepared.

***THIS PAGE INTENTIONALLY LEFT BLANK***



# STANISLAUS COUNTY LAND USE DIAGRAM INDEX

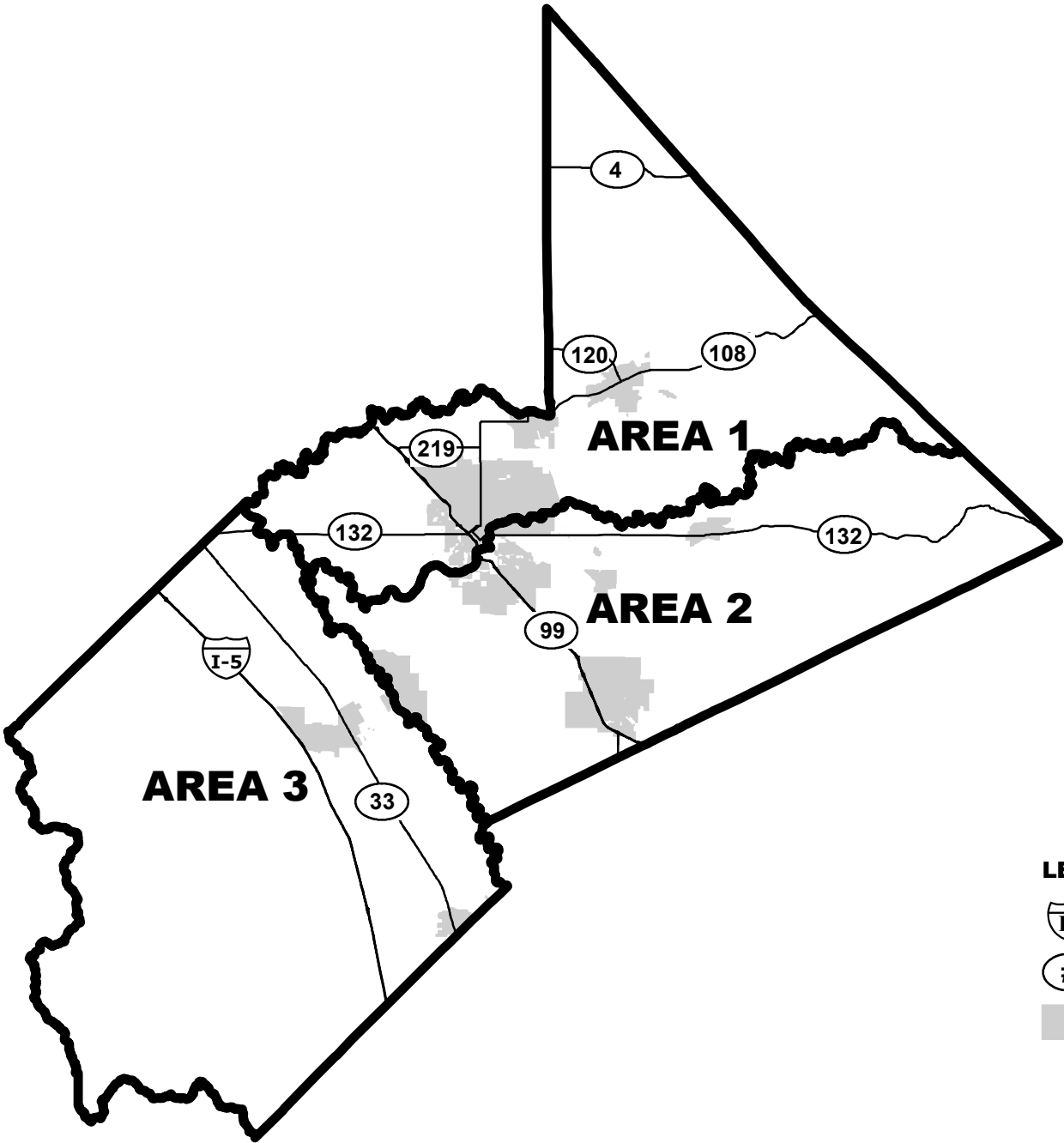

**LEGEND:**

-  = Freeway
-  = Highway
-  = Cities



***THIS PAGE INTENTIONALLY LEFT BLANK***

# STANISLAUS COUNTY LAND USE DIAGRAM AREA 1

## LAND USE DIAGRAM AREA 1 INDEX:

- 1-A Claribel Rd./Oakdale-Waterford Hwy.
- 1-B Del Rio
- 1-C Knights Ferry
- 1-D Modesto (Carpenter Rd./Woodland Ave.)
- 1-E Modesto (Carpenter Rd./Paradise Rd.)
- 1-F North McHenry Ave.
- 1-G Oakdale Area
- 1-H Riverbank Area
- 1-I Salida
- 1-J Valley Home

## LEGEND:

-  = Highway
-  = Cities

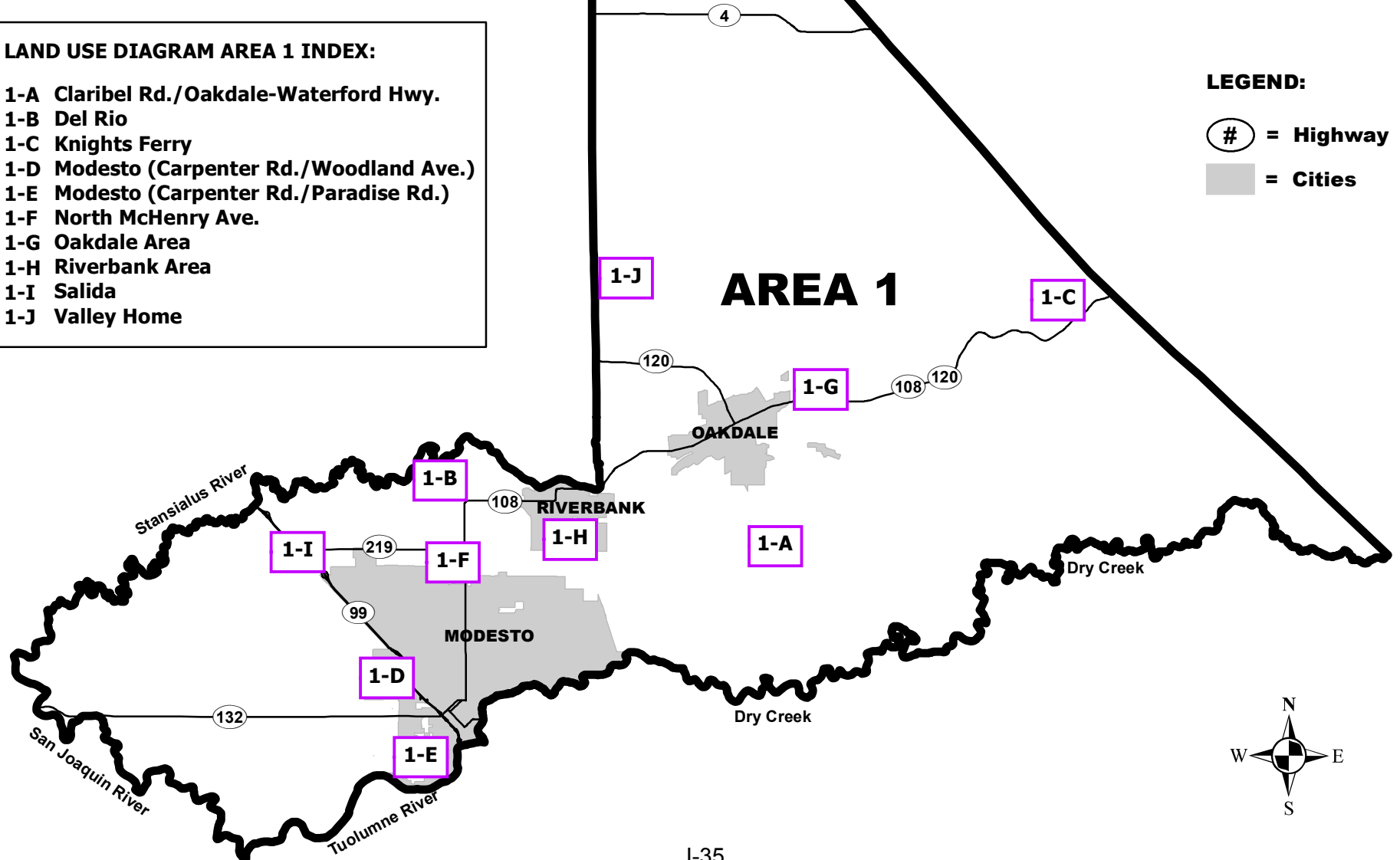

***THIS PAGE INTENTIONALLY LEFT BLANK***

# STANISLAUS COUNTY LAND USE DIAGRAM AREA 2

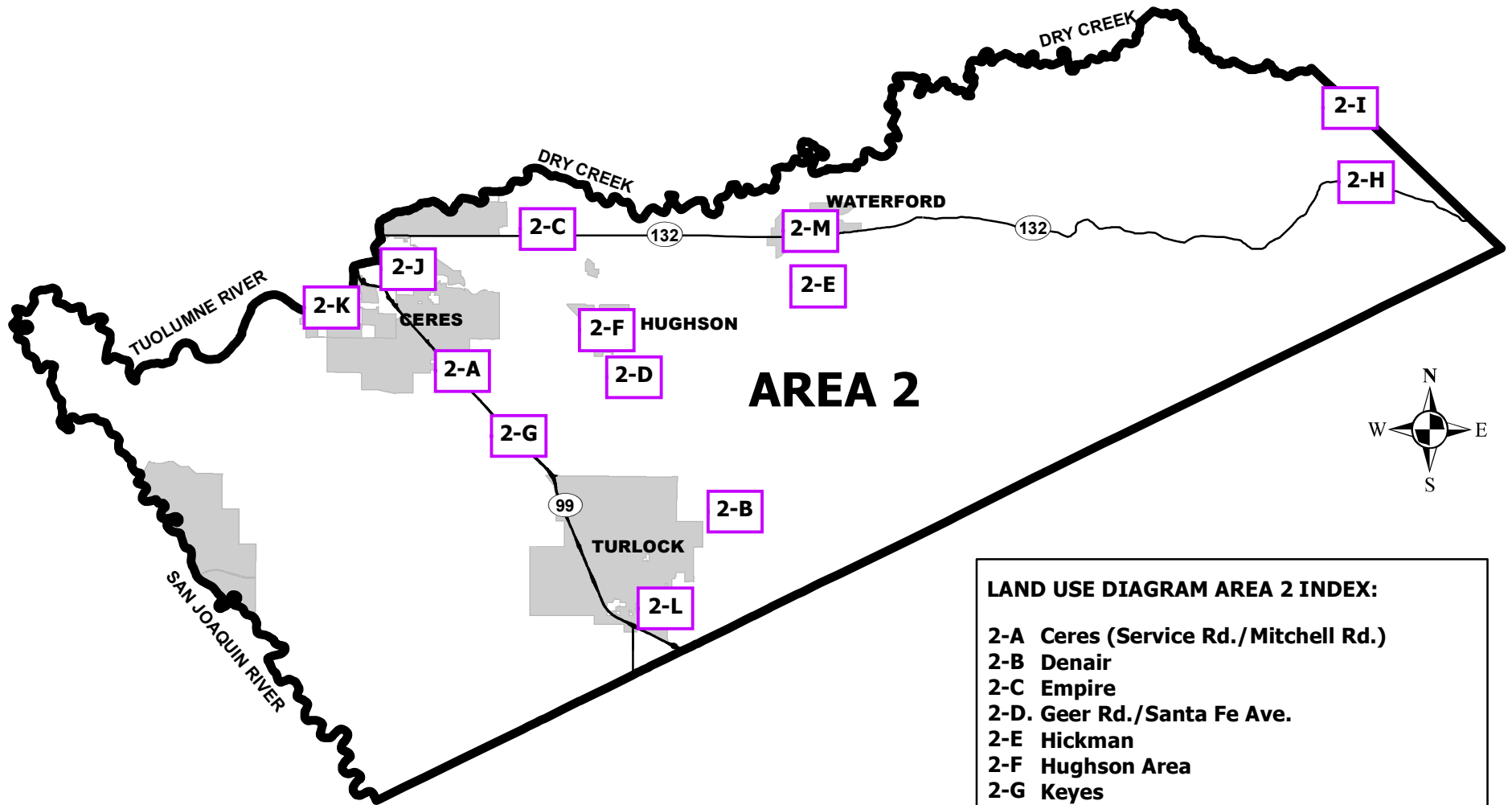

**LEGEND:**

- # = Highway
- = Cities

LAND USE DIAGRAM AREA 2 INDEX:	
2-A	Ceres (Service Rd./ Mitchell Rd.)
2-B	Denair
2-C	Empire
2-D	Geer Rd./ Santa Fe Ave.
2-E	Hickman
2-F	Hughson Area
2-G	Keys
2-H	La Grange
2-I	La Grange Rd./ County Line
2-J	Modesto/ Ceres Area
2-K	Modesto (Carpenter Rd./ Whitmore Ave.)
2-L	Turlock Area
2-M	Waterford Area

***THIS PAGE INTENTIONALLY LEFT BLANK***

# STANISLAUS COUNTY LAND USE DIAGRAM AREA 3

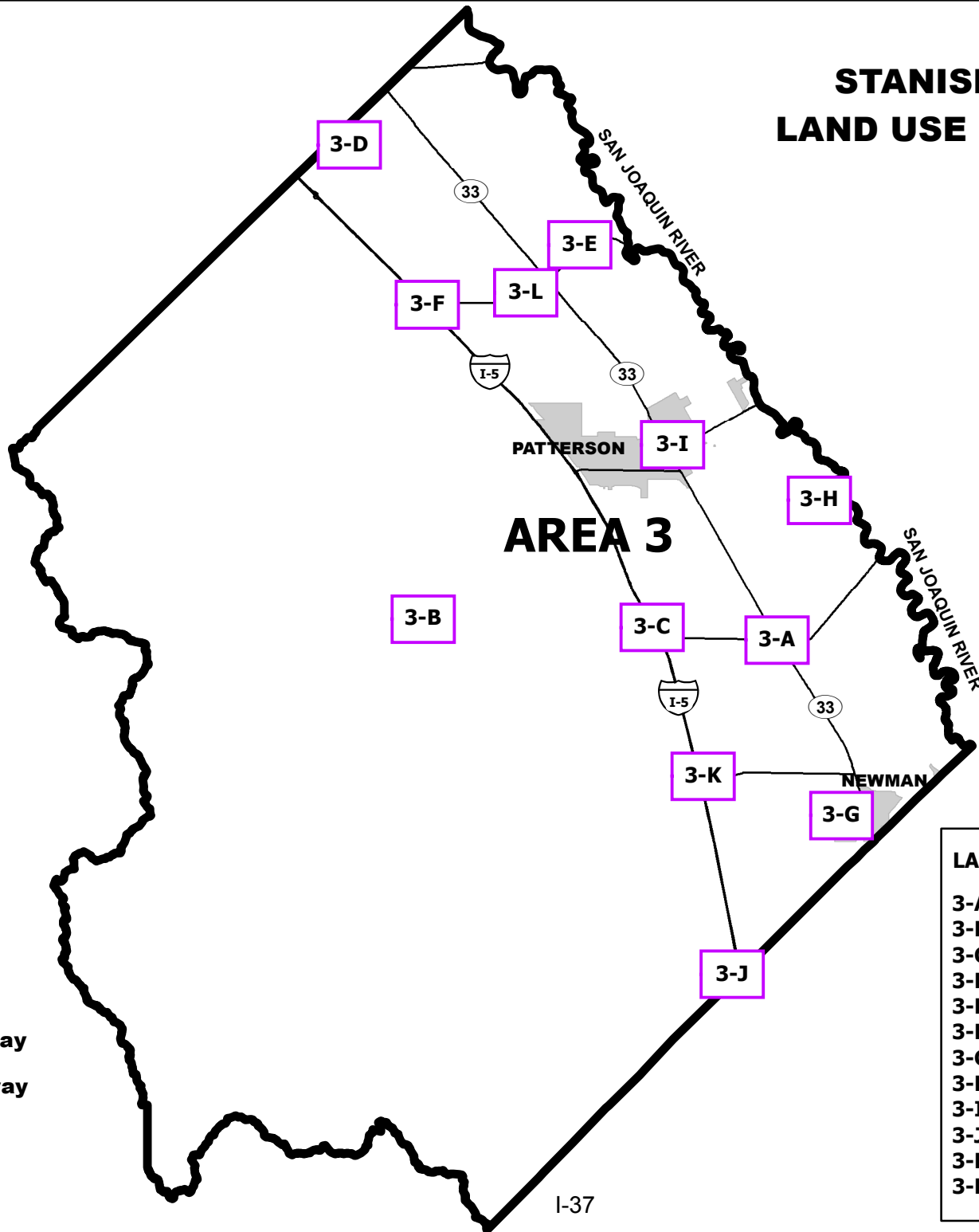

## LEGEND:

-  = Freeway
-  = Highway
-  = Cities

## LAND USE DIAGRAM AREA 3 INDEX:

- 3-A Crows Landing
- 3-B Diablo Grande
- 3-C Fink Rd. Intersection
- 3-D Gaffery Rd./County Line Area
- 3-E Grayson
- 3-F Howard Rd./Mc Cracken Rd.
- 3-G Newman Area
- 3-H Paradise Ave./Prune Ave.
- 3-I Patterson Area
- 3-J Sullivan Rd. Intersection
- 3-K West Stuhr Rd. Intersection
- 3-L Westley

***THIS PAGE INTENTIONALLY LEFT BLANK***



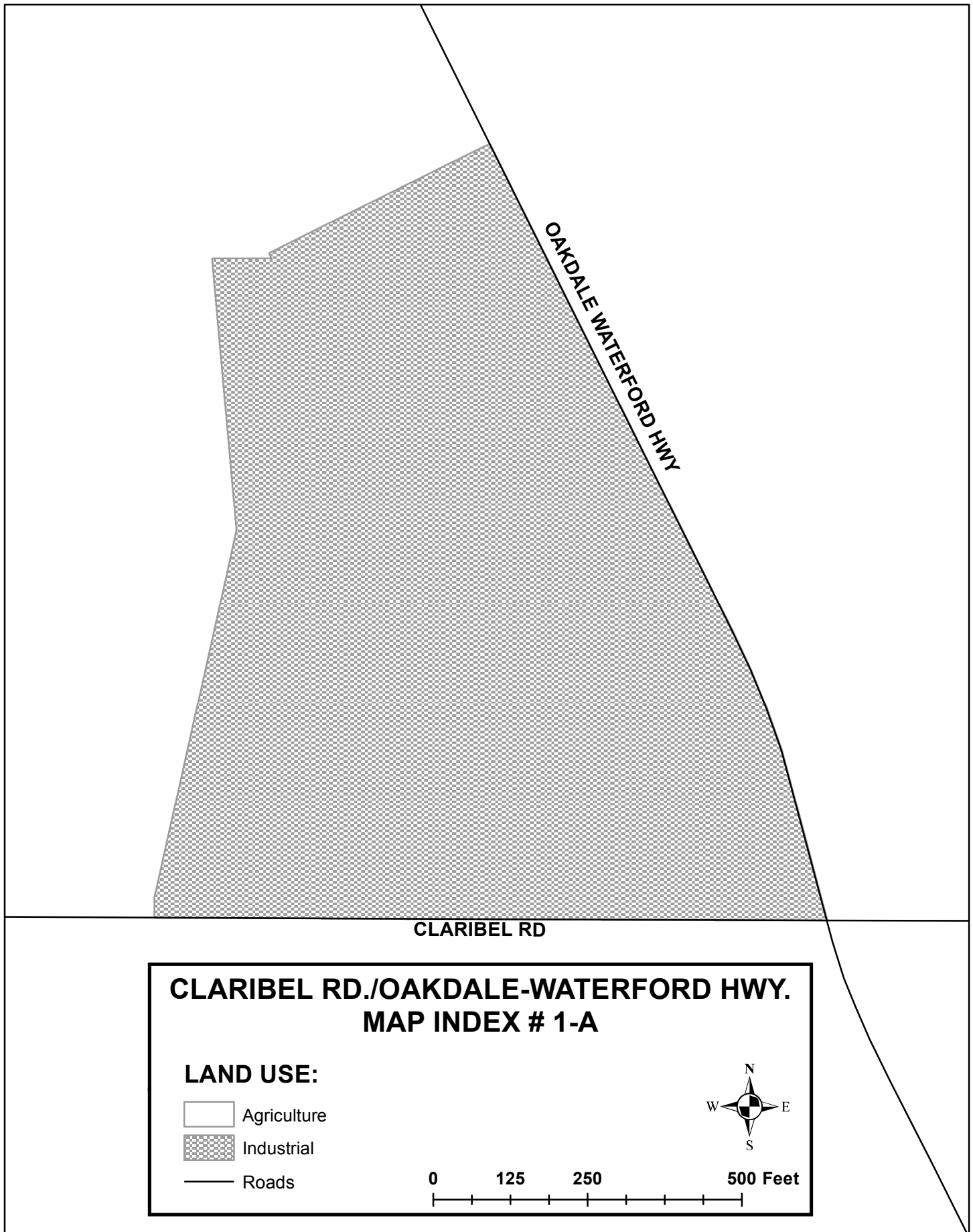

***THIS PAGE INTENTIONALLY LEFT BLANK***

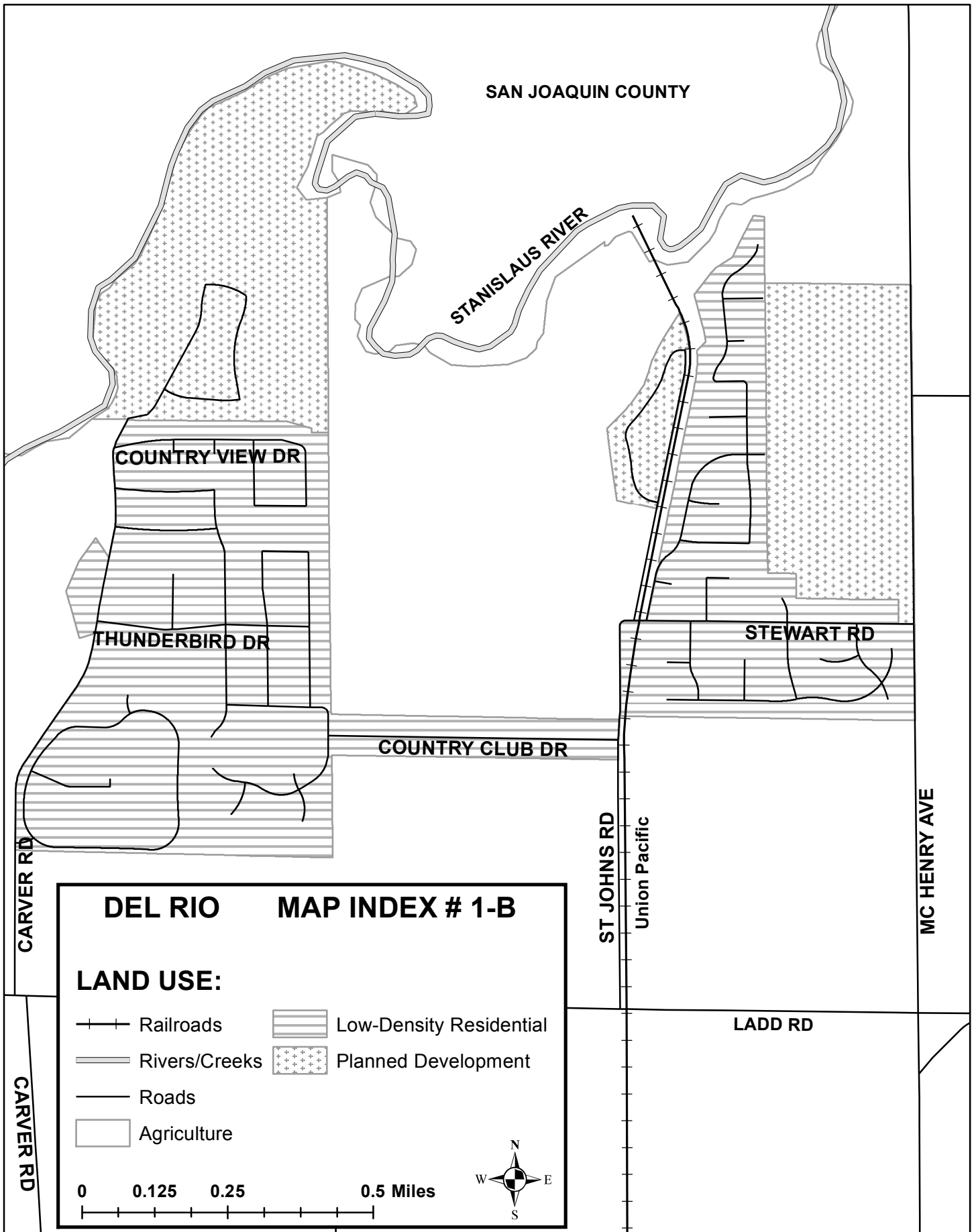

***THIS PAGE INTENTIONALLY LEFT BLANK***

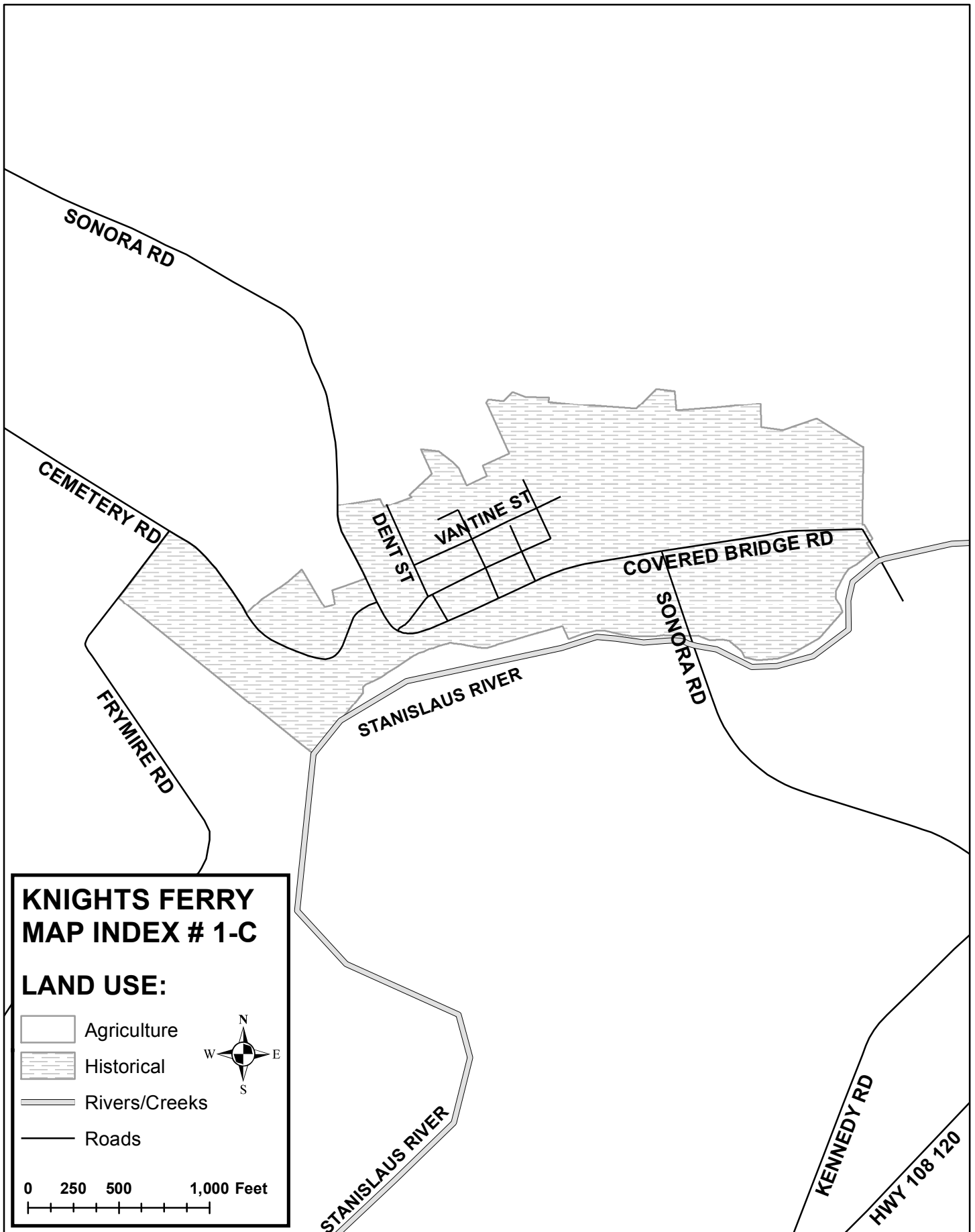

***THIS PAGE INTENTIONALLY LEFT BLANK***

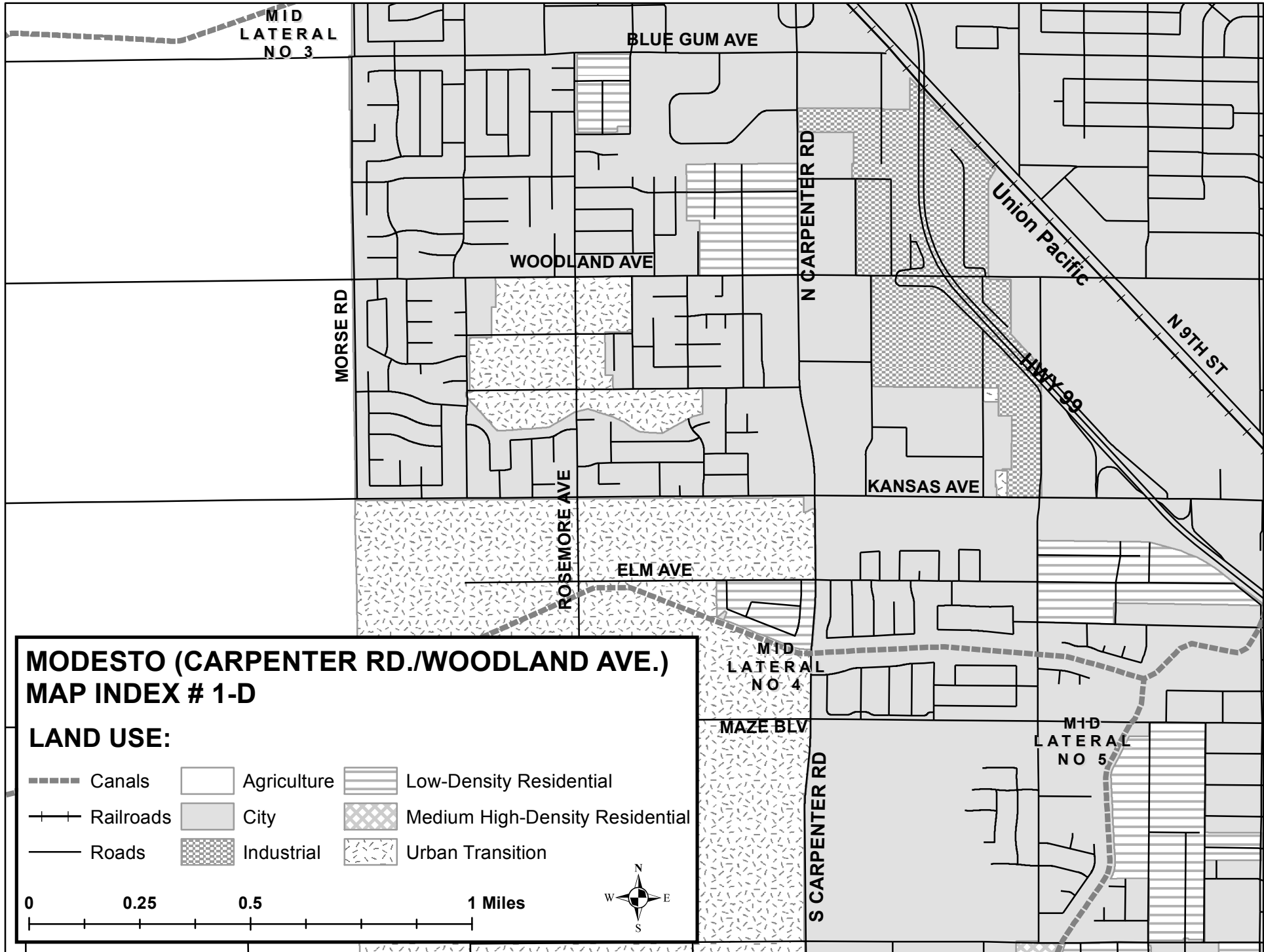

***THIS PAGE INTENTIONALLY LEFT BLANK***



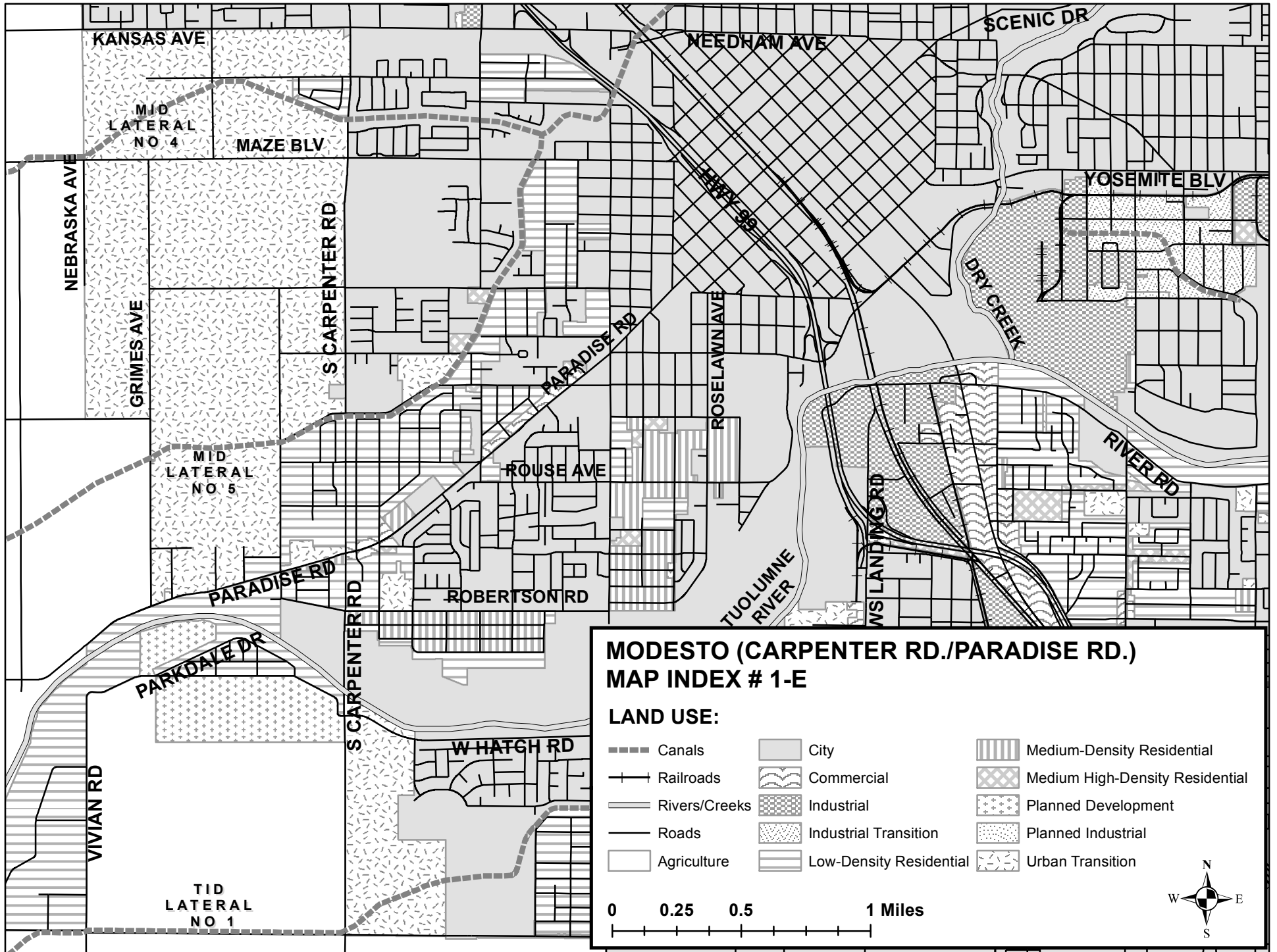

***THIS PAGE INTENTIONALLY LEFT BLANK***

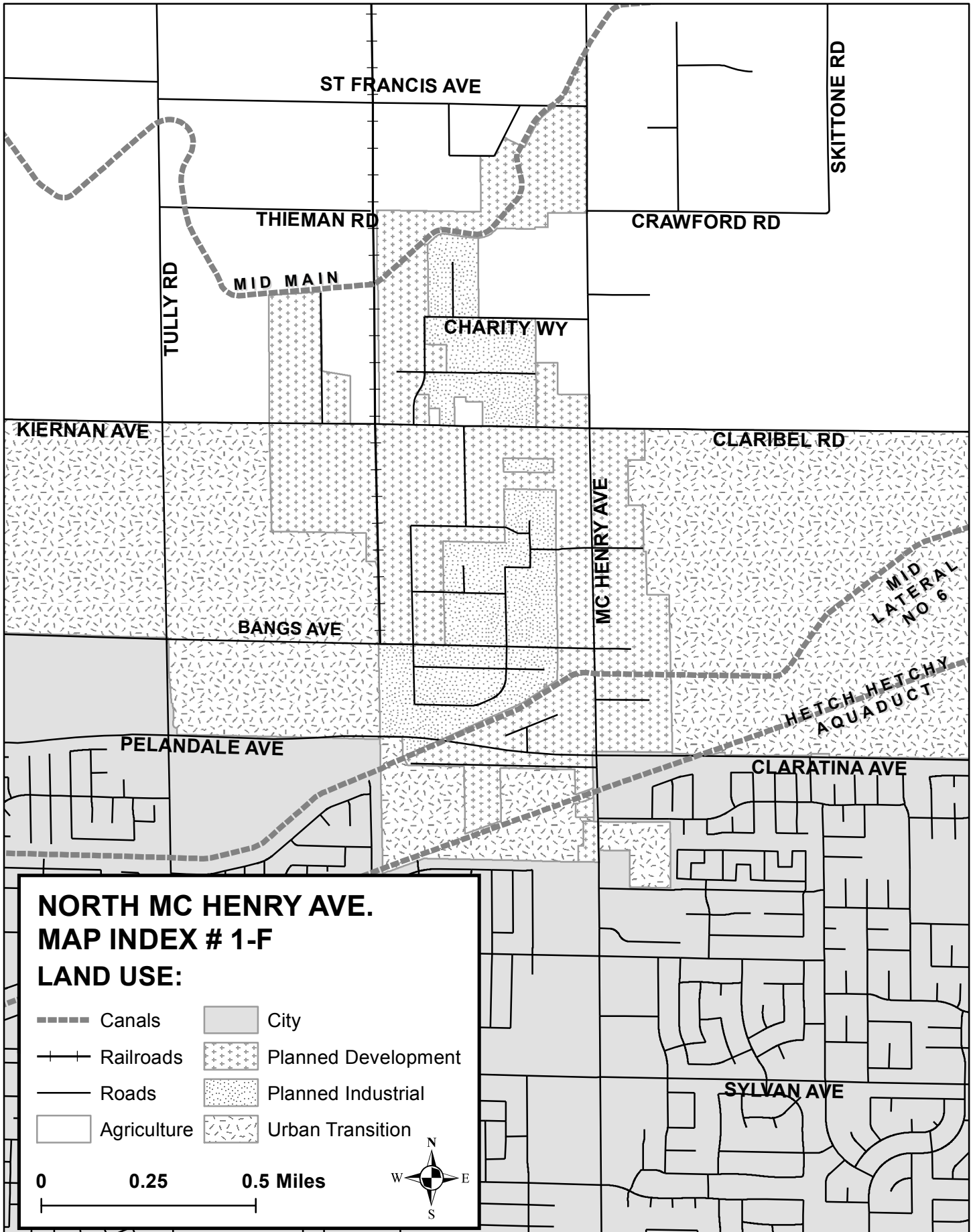

***THIS PAGE INTENTIONALLY LEFT BLANK***

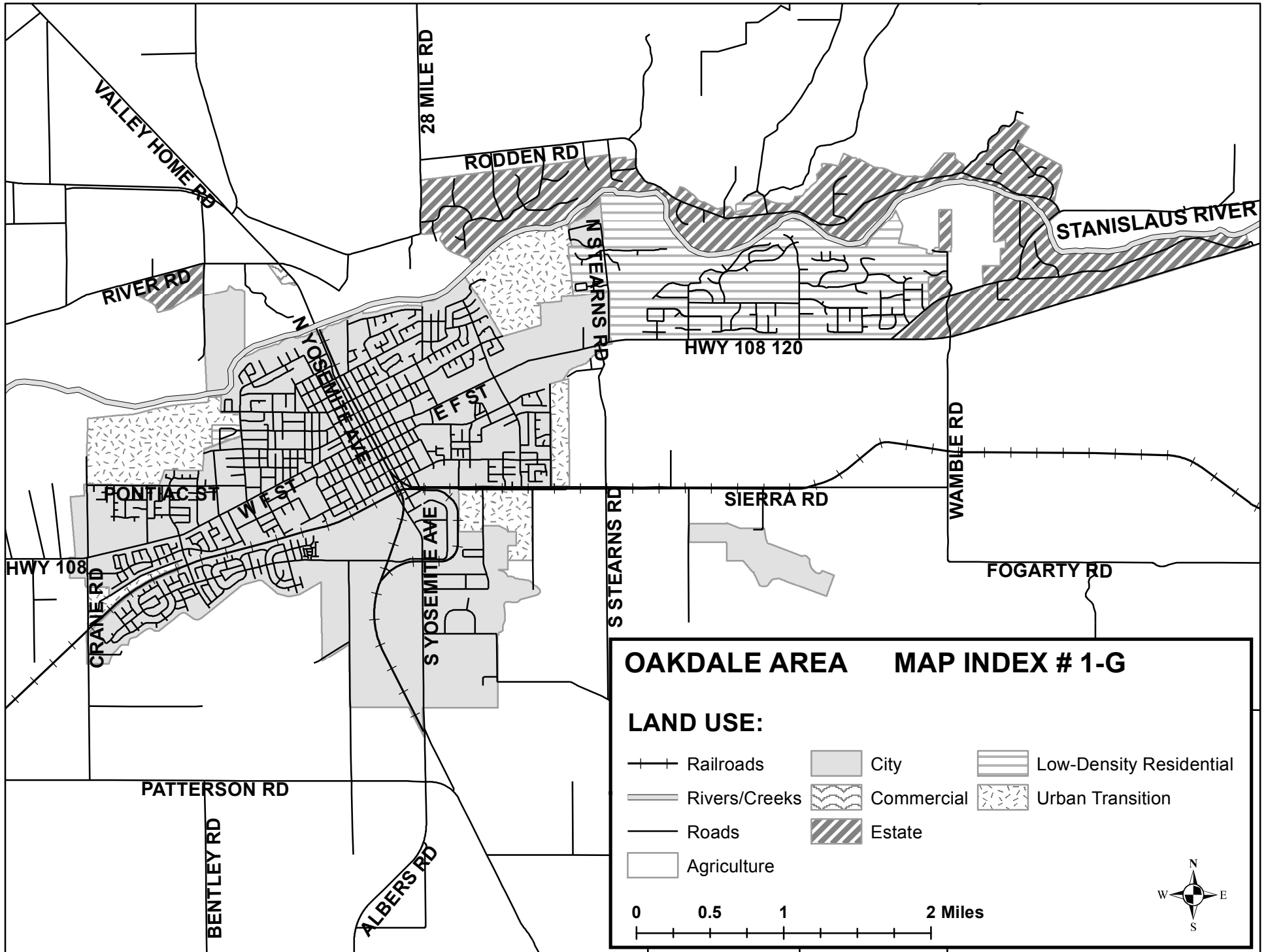

***THIS PAGE INTENTIONALLY LEFT BLANK***

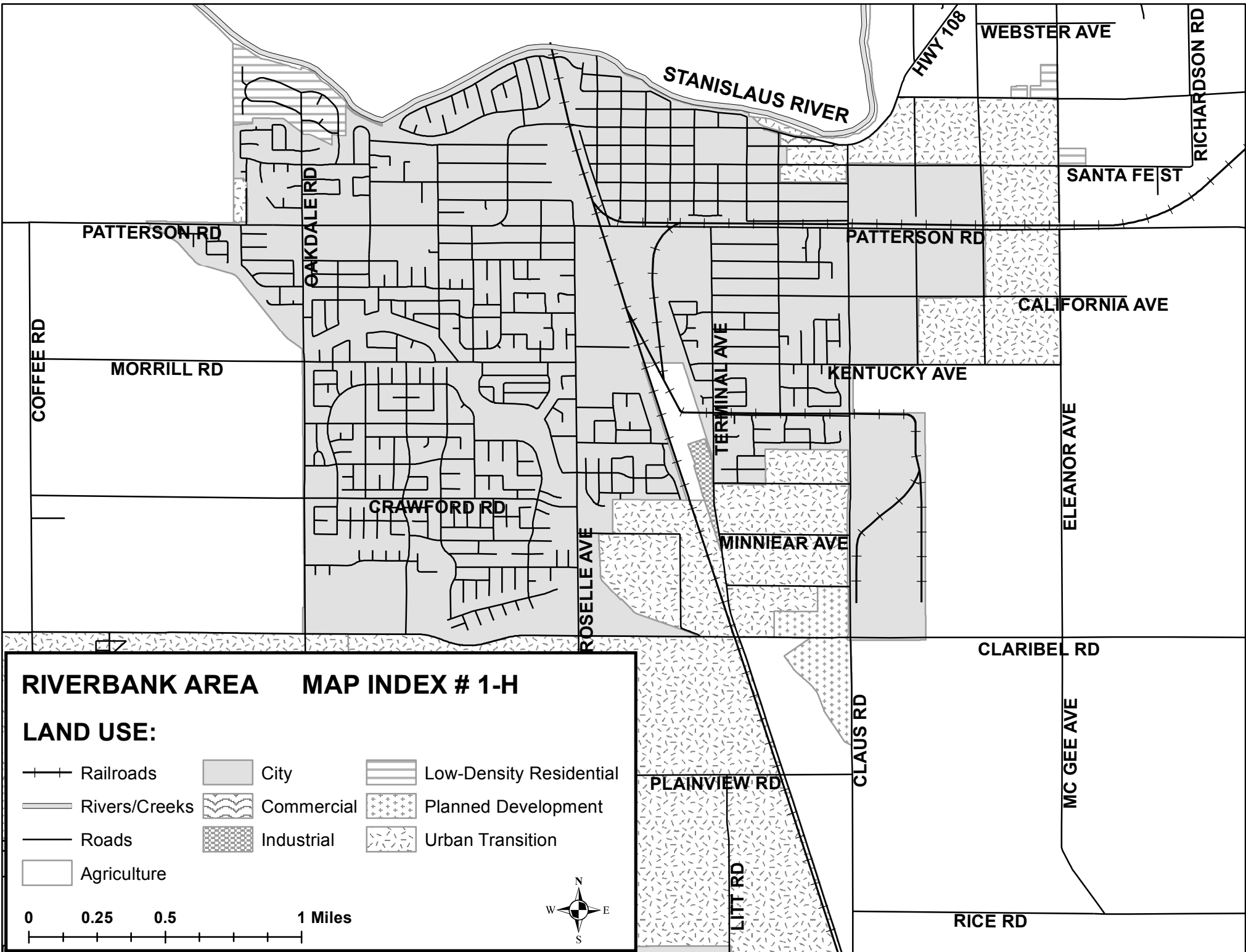

***THIS PAGE INTENTIONALLY LEFT BLANK***



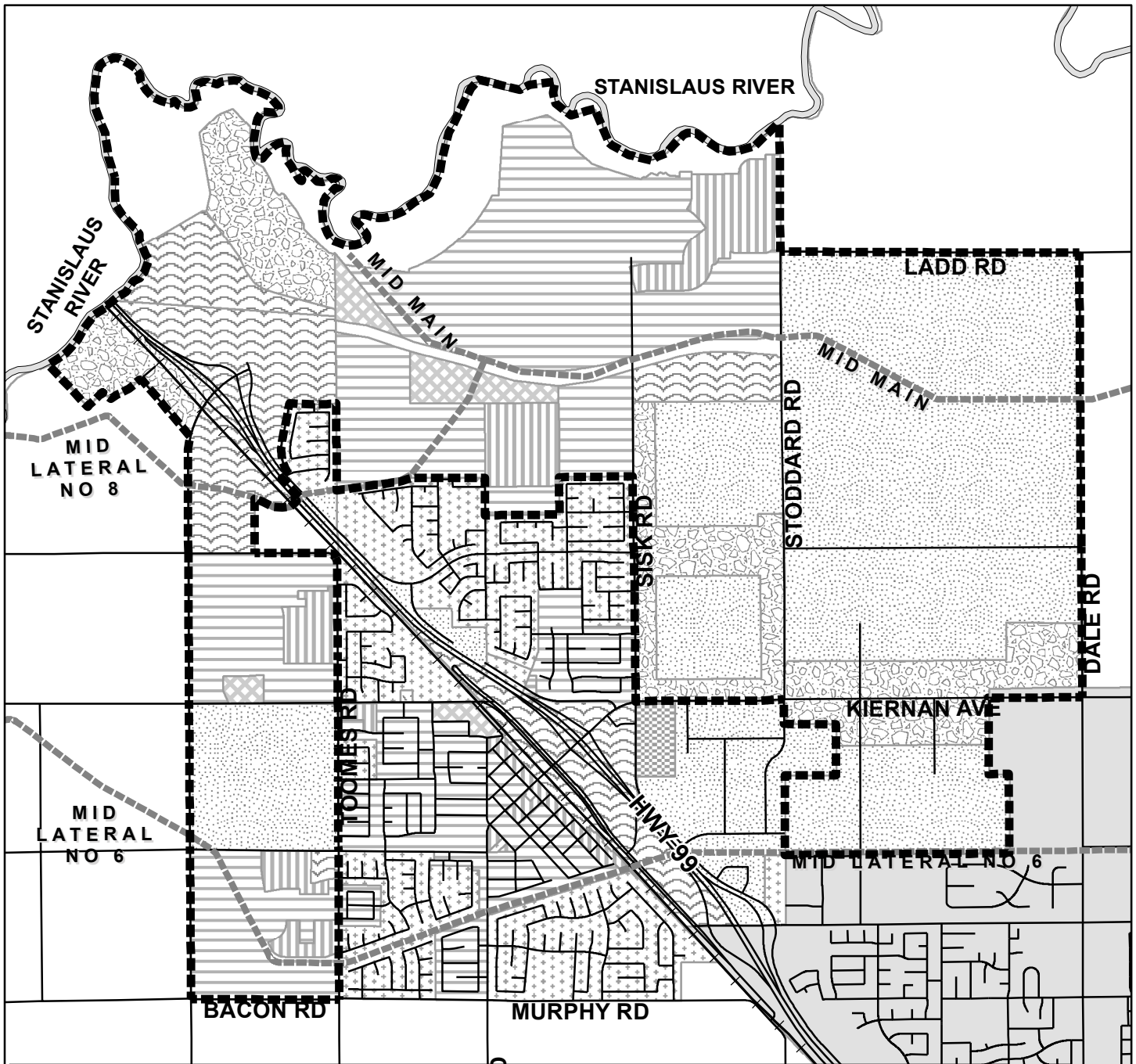

## SALIDA MAP INDEX # 1-I

### LAND USE:

- |  |   |   |
|--|---|---|
| <ul style="list-style-type: none"> <li>■ Amendment Area Boundary</li> <li>--- Canals</li> <li>+ Railroads</li> <li>— Rivers/Creeks</li> <li>— Roads</li> </ul> | <ul style="list-style-type: none"> <li>□ Agriculture</li> <li>■ City</li> <li>▨ Commercial</li> <li>▨ Highway Comm./Planned Dev.</li> <li>▨ Industrial Business Park</li> <li>▨ Industrial</li> </ul> | <ul style="list-style-type: none"> <li>▨ Low-Density Residential</li> <li>▨ Medium-Density Residential</li> <li>▨ Medium High-Density Residential</li> <li>▨ Planned Development</li> <li>▨ Planned Industrial</li> <li>▨ Urban Transition</li> </ul> |
|--|---|---|

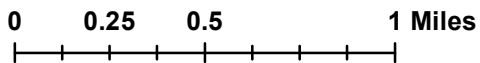

***THIS PAGE INTENTIONALLY LEFT BLANK***

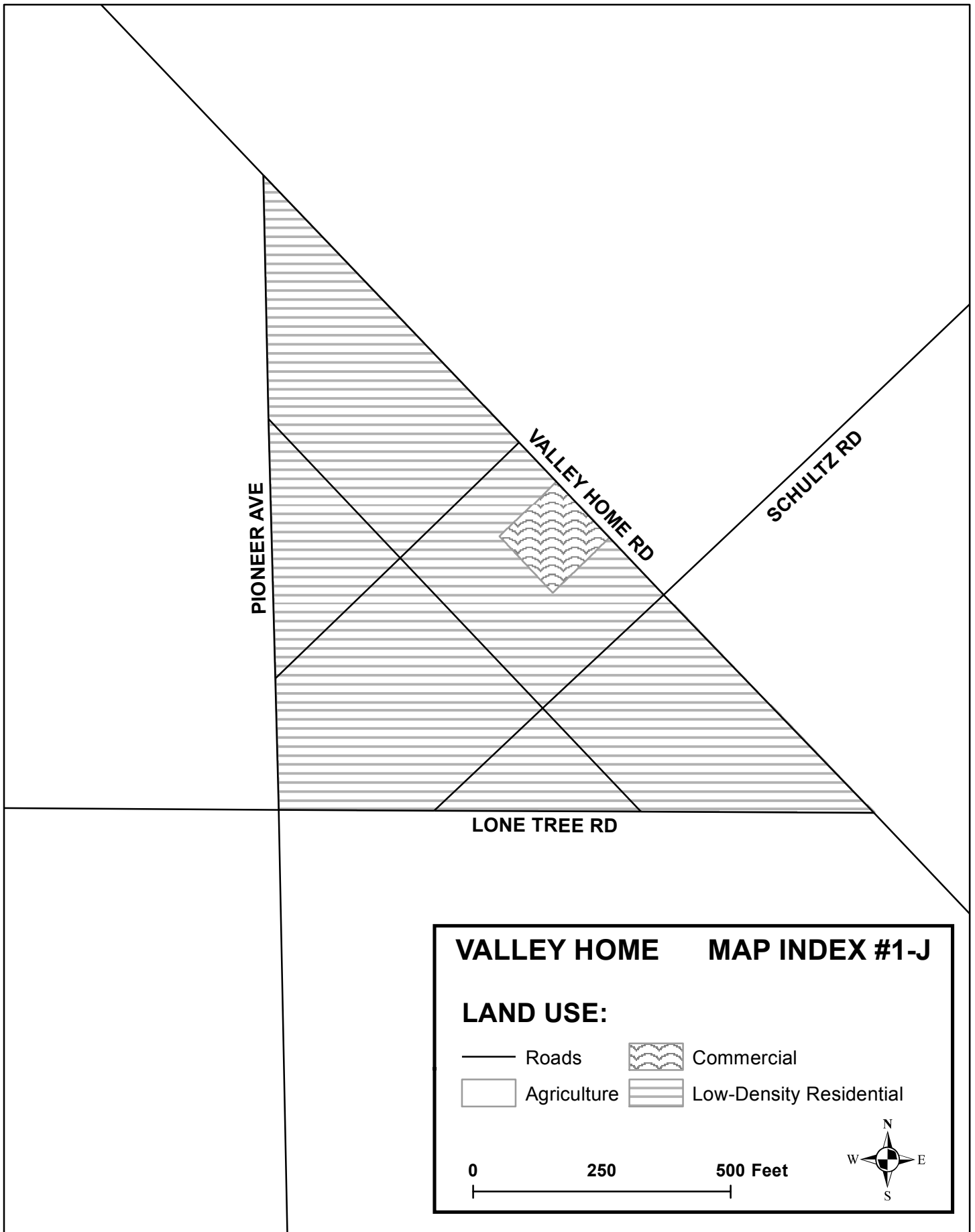

***THIS PAGE INTENTIONALLY LEFT BLANK***

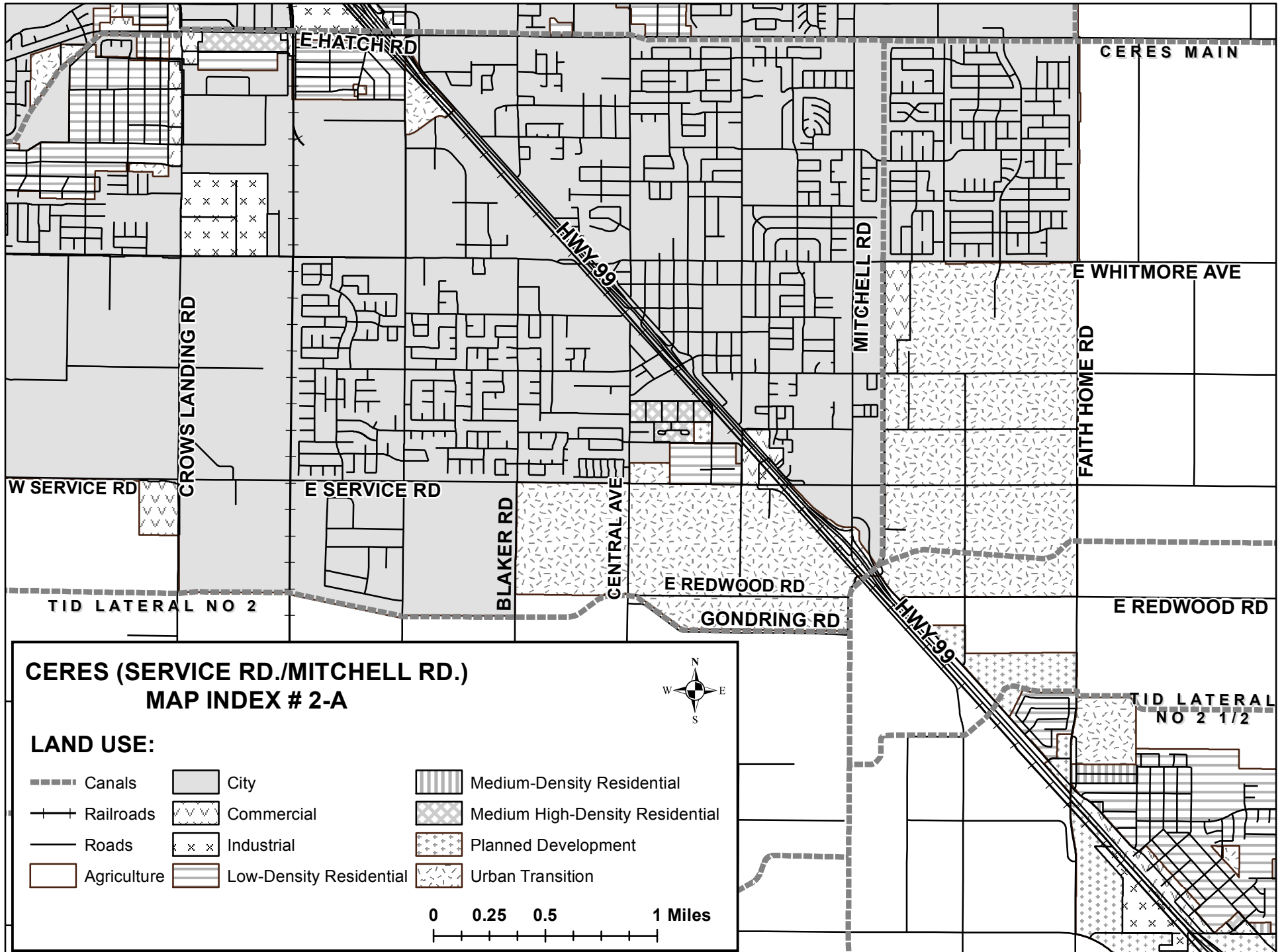

***THIS PAGE INTENTIONALLY LEFT BLANK***

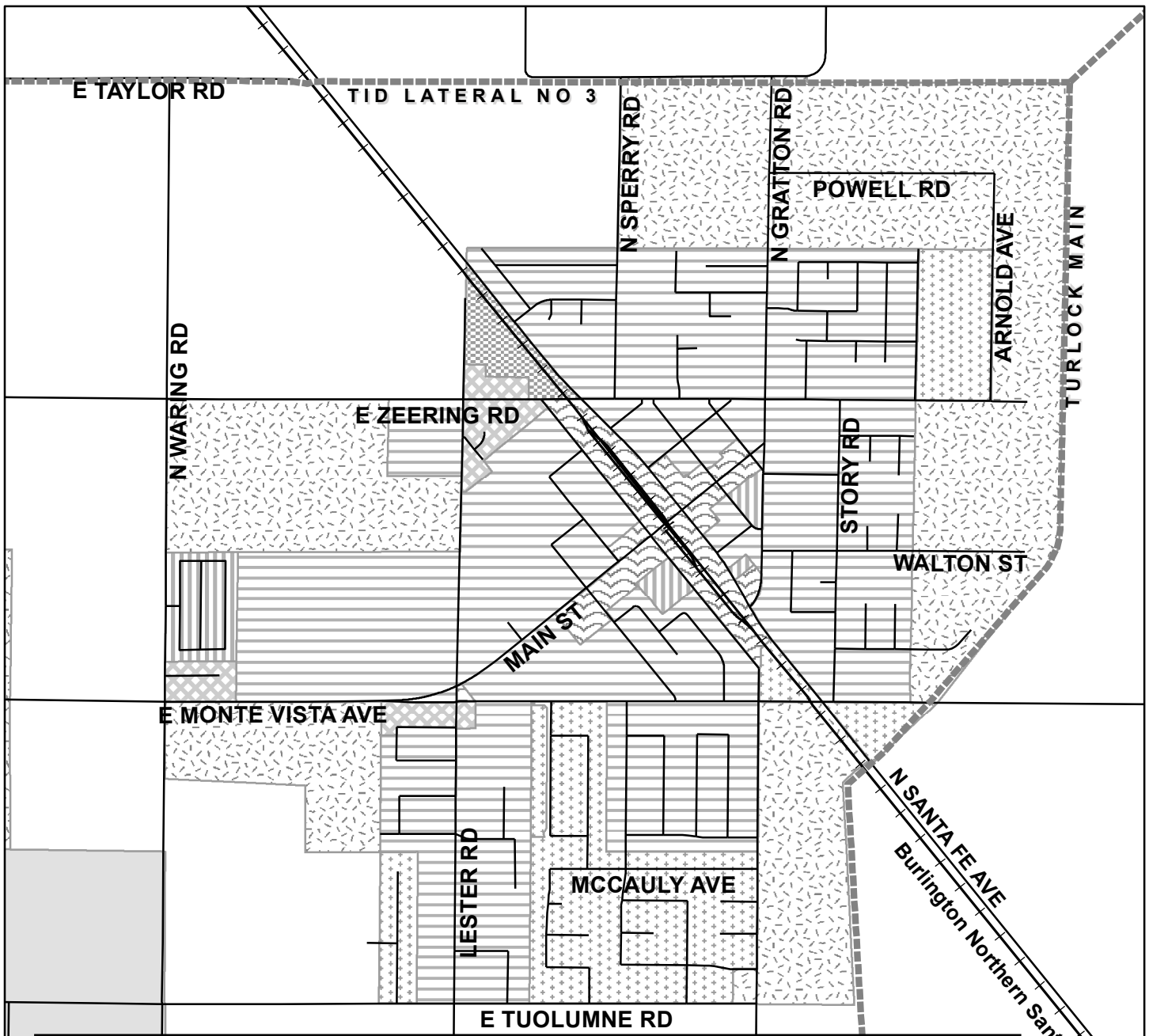

**DENAIR MAP INDEX # 2-B**

**LAND USE:**

- |                         |                                 |           |
|-------------------------|---------------------------------|-----------|
| Agriculture             | Medium-Density Residential      | Railroads |
| City                    | Medium High-Density Residential | Roads     |
| Commercial              | Planned Development             |           |
| Industrial              | Urban Transition                |           |
| Low-Density Residential | Canals                          |           |

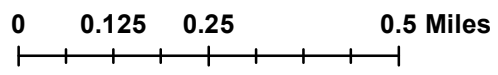

***THIS PAGE INTENTIONALLY LEFT BLANK***



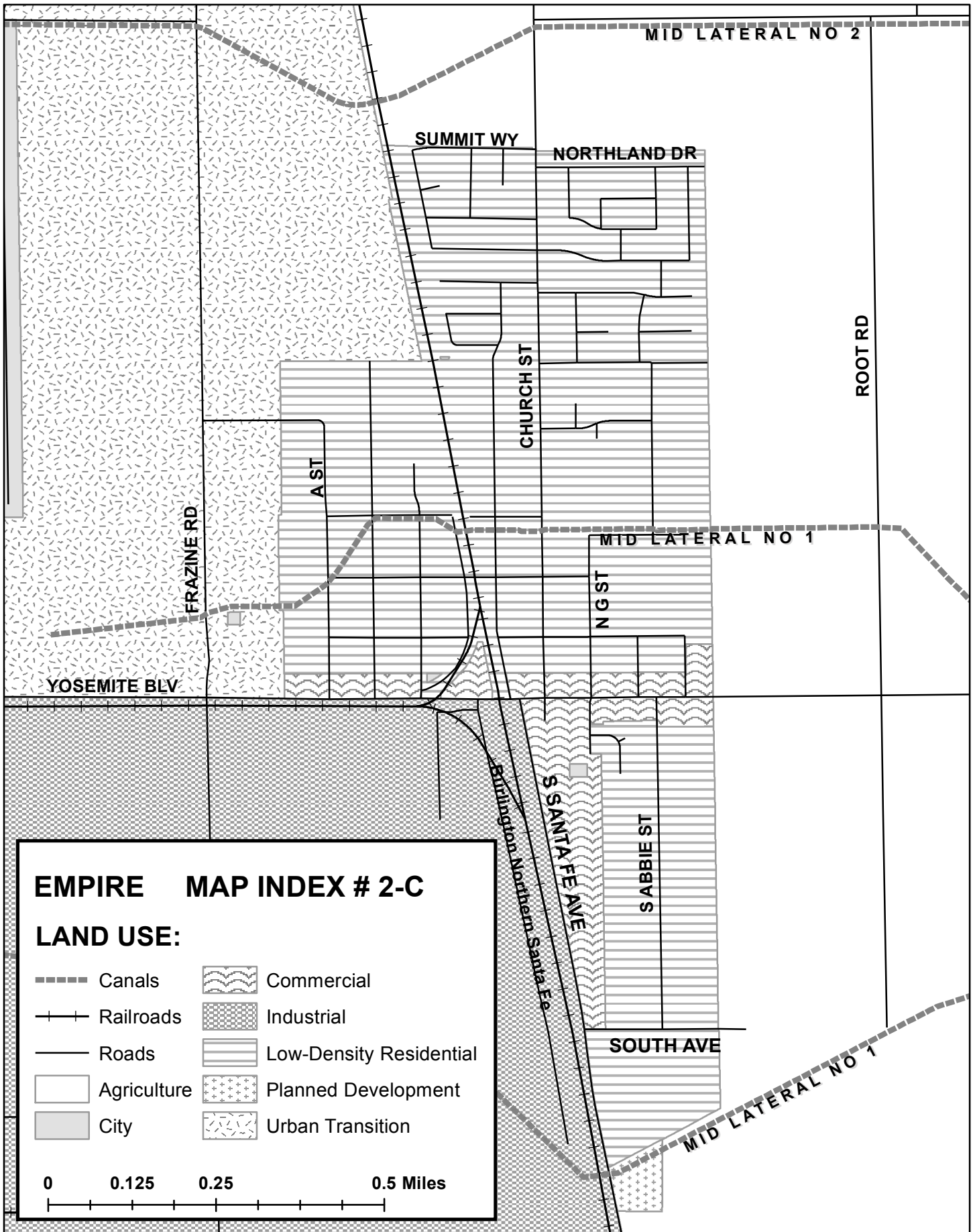

***THIS PAGE INTENTIONALLY LEFT BLANK***

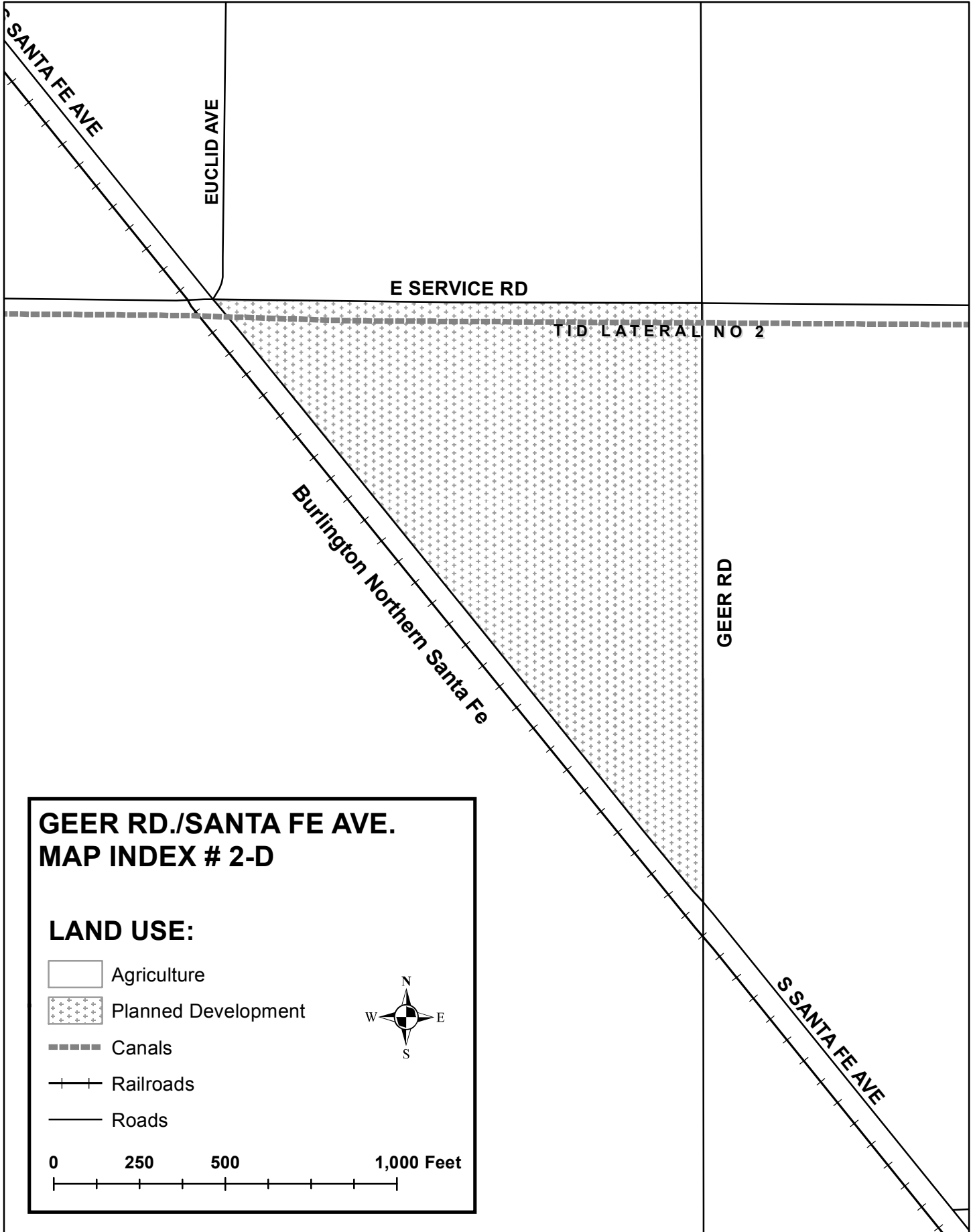

***THIS PAGE INTENTIONALLY LEFT BLANK***

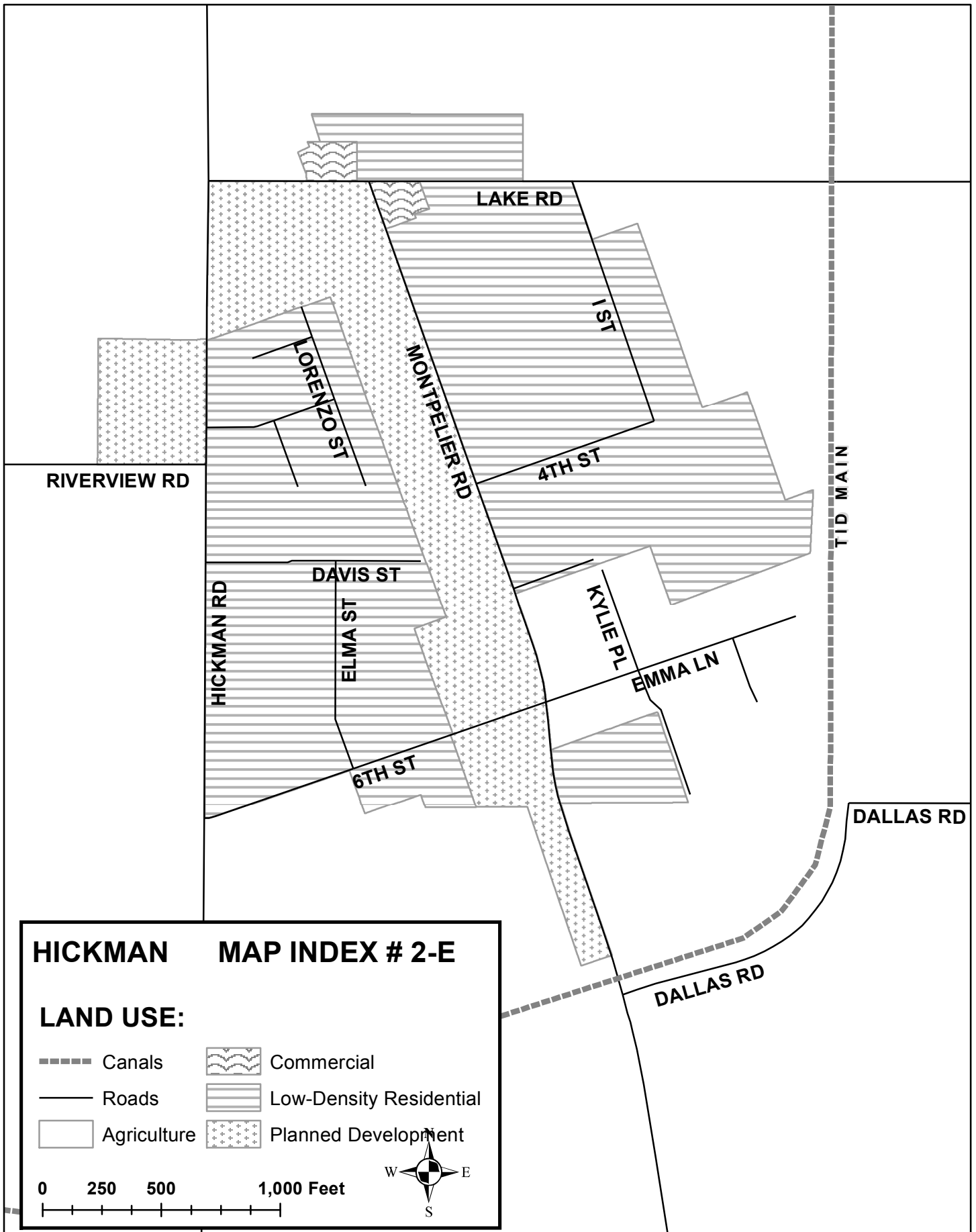



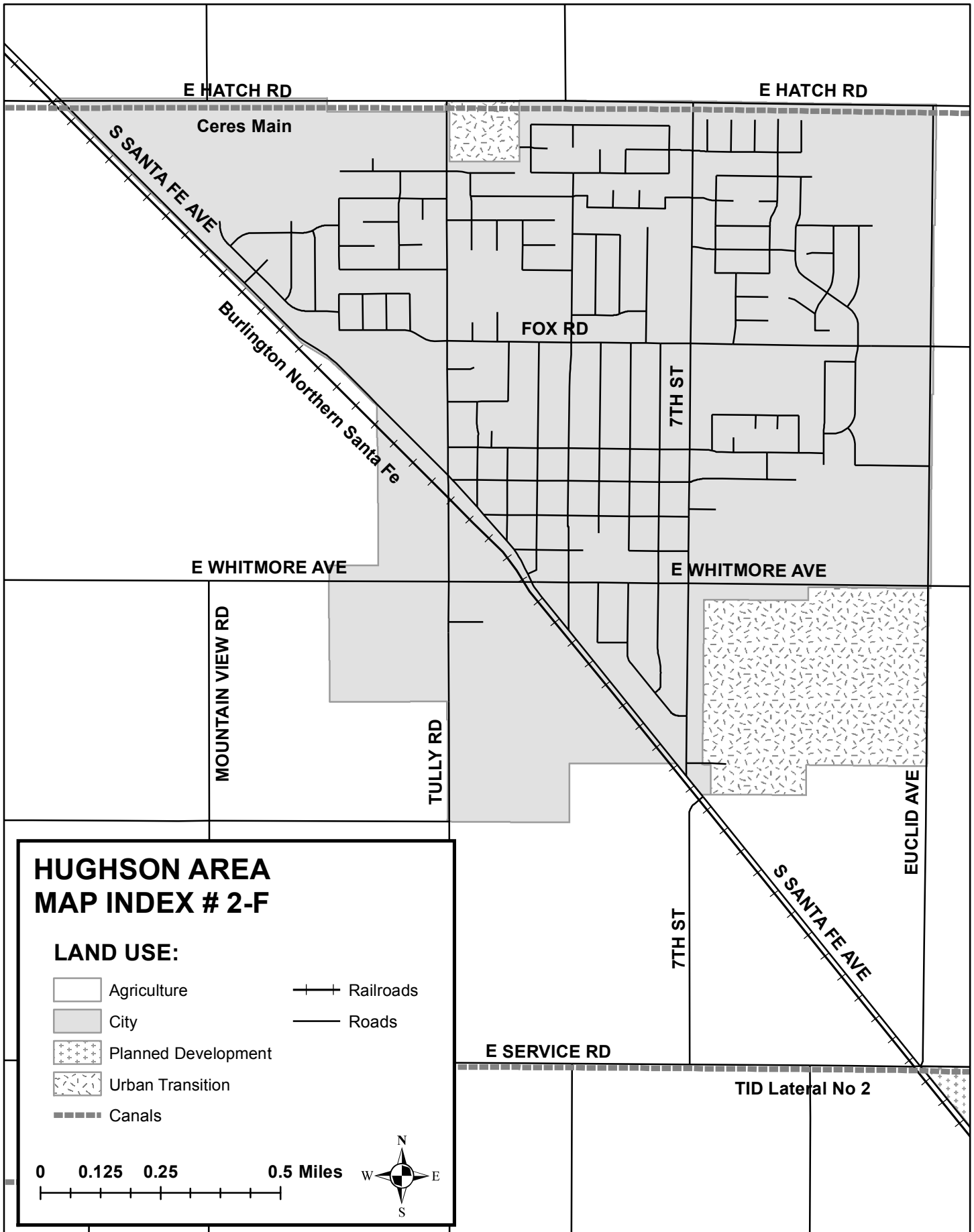



***THIS PAGE INTENTIONALLY LEFT BLANK***



**HUGHSON AREA  
MAP INDEX # 2-F**

**LAND USE:**

-  Agriculture
-  City
-  Planned Development
-  Urban Transition
-  Canals
-  Railroads
-  Roads

0 0.125 0.25 0.5 Miles



***THIS PAGE INTENTIONALLY LEFT BLANK***



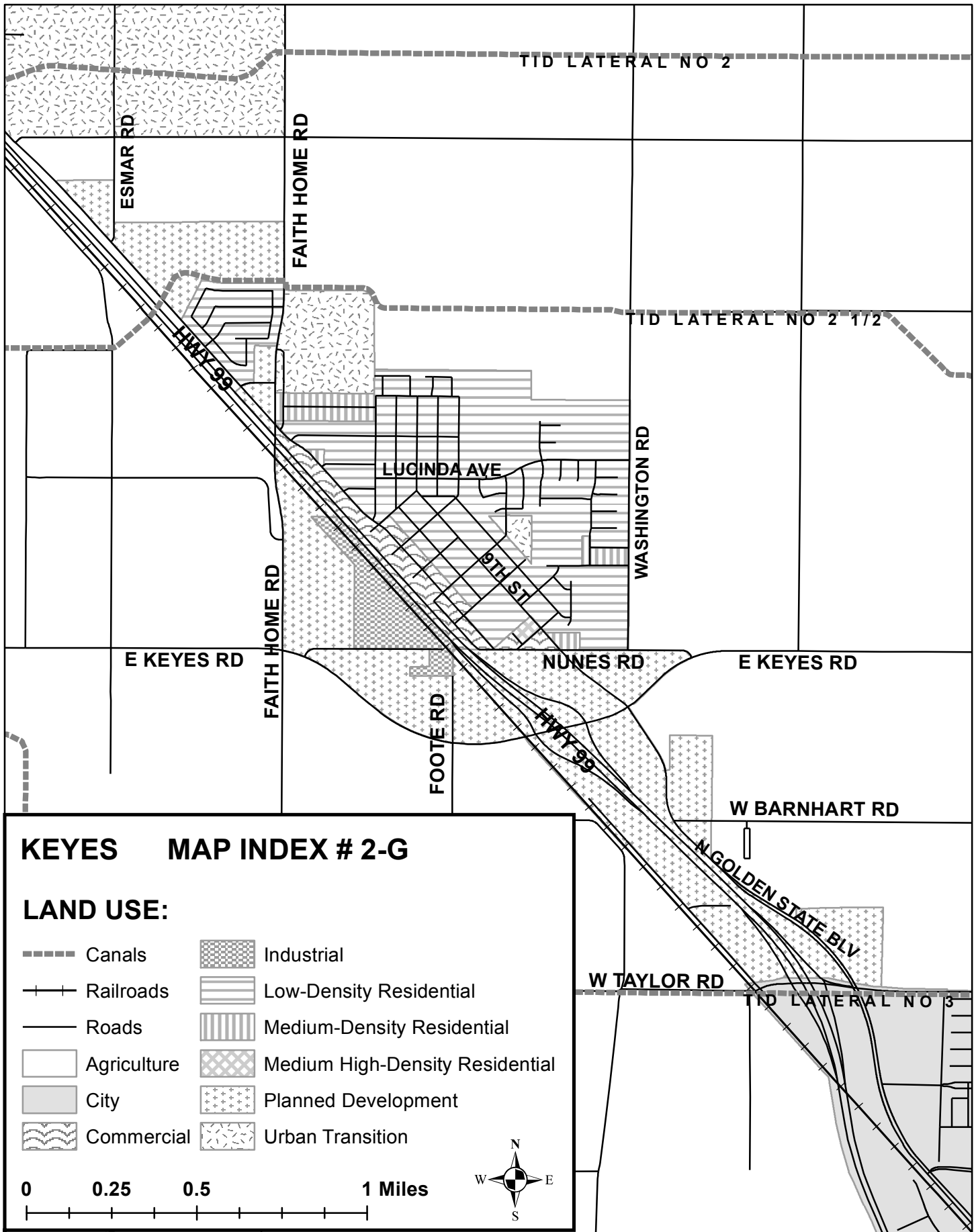

**KEYES MAP INDEX # 2-G**

**LAND USE:**

- |             |                                 |
|-------------|---------------------------------|
| Canals      | Industrial                      |
| Railroads   | Low-Density Residential         |
| Roads       | Medium-Density Residential      |
| Agriculture | Medium High-Density Residential |
| City        | Planned Development             |
| Commercial  | Urban Transition                |

0      0.25      0.5      1 Miles



***THIS PAGE INTENTIONALLY LEFT BLANK***

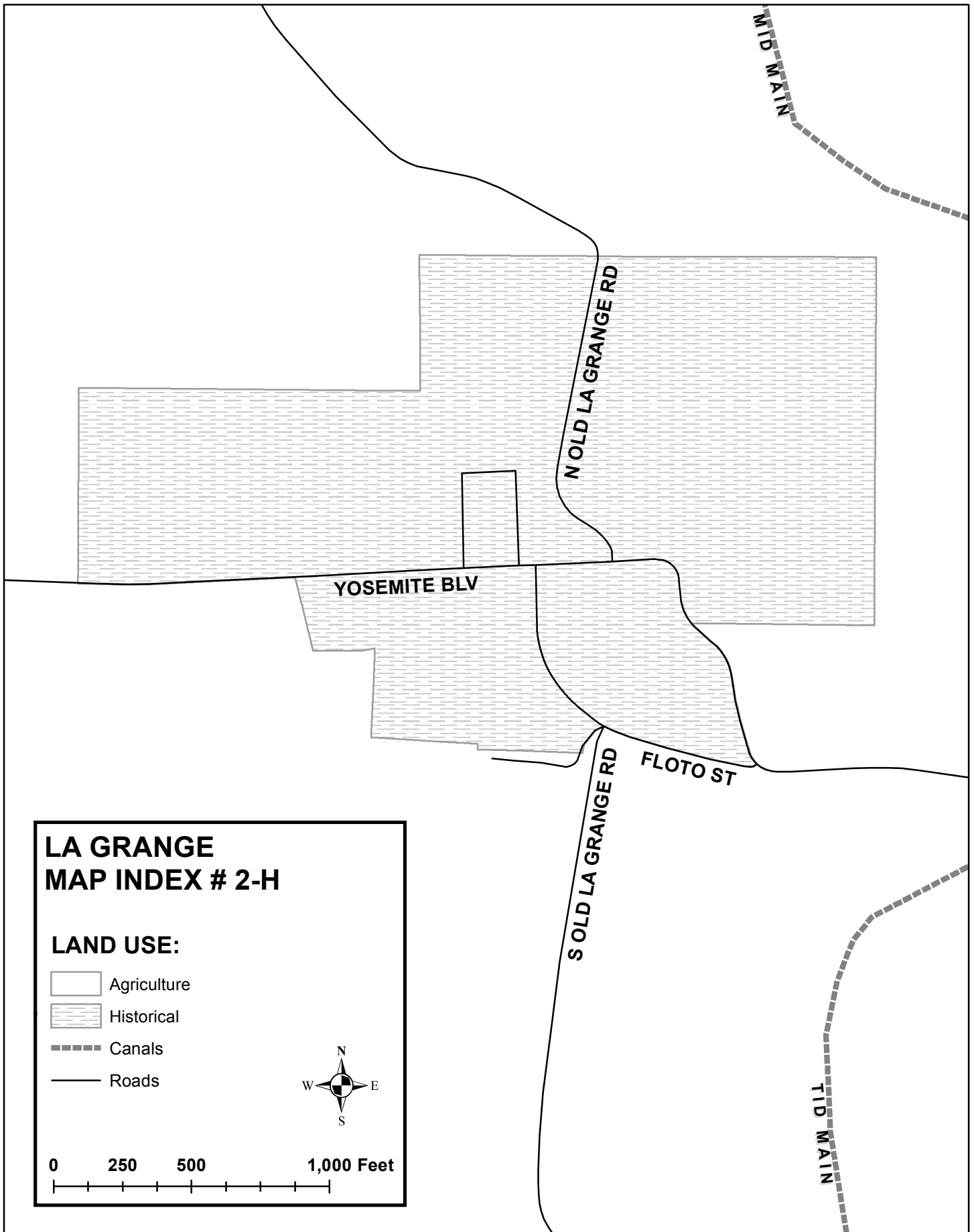

***THIS PAGE INTENTIONALLY LEFT BLANK***

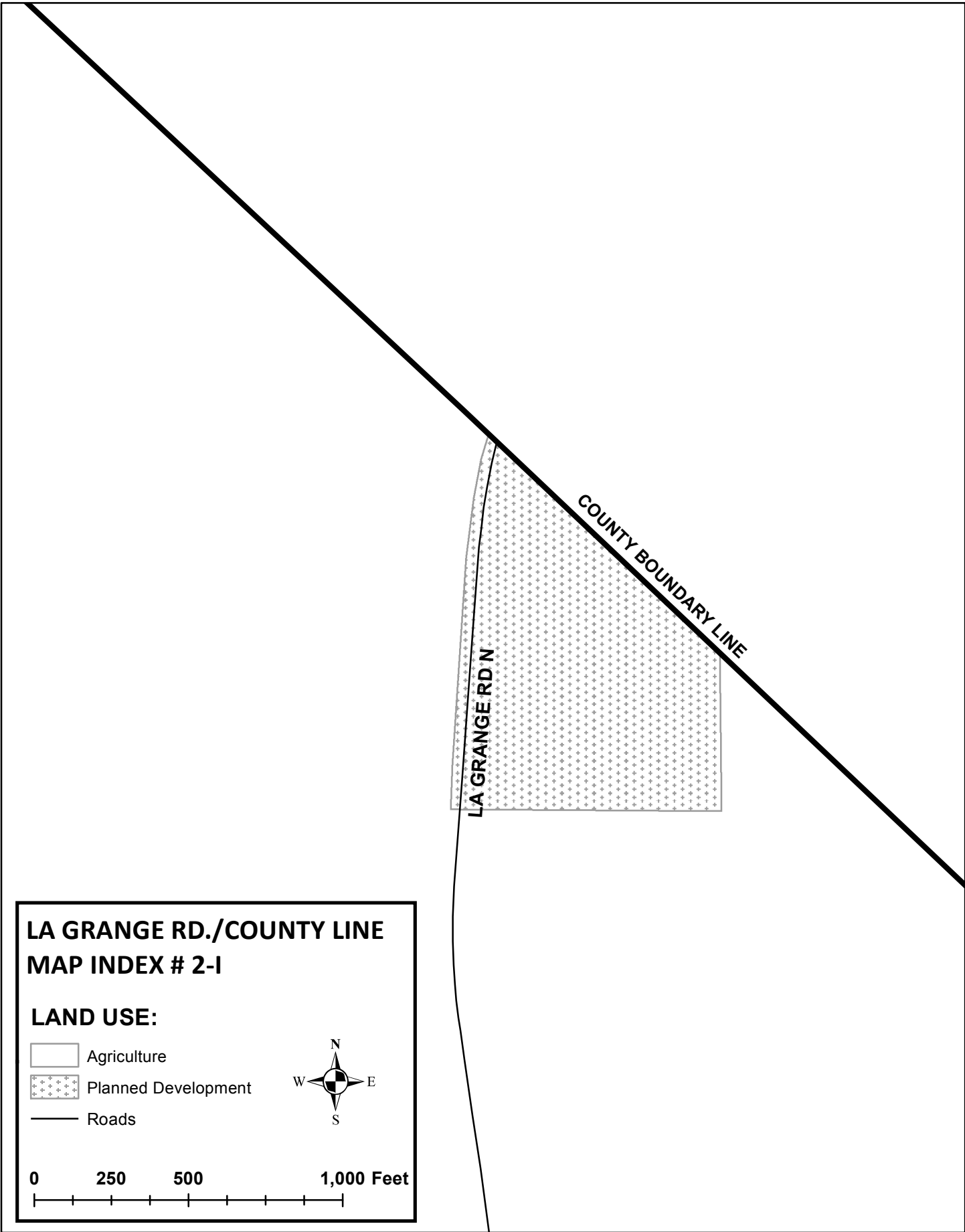

***THIS PAGE INTENTIONALLY LEFT BLANK***

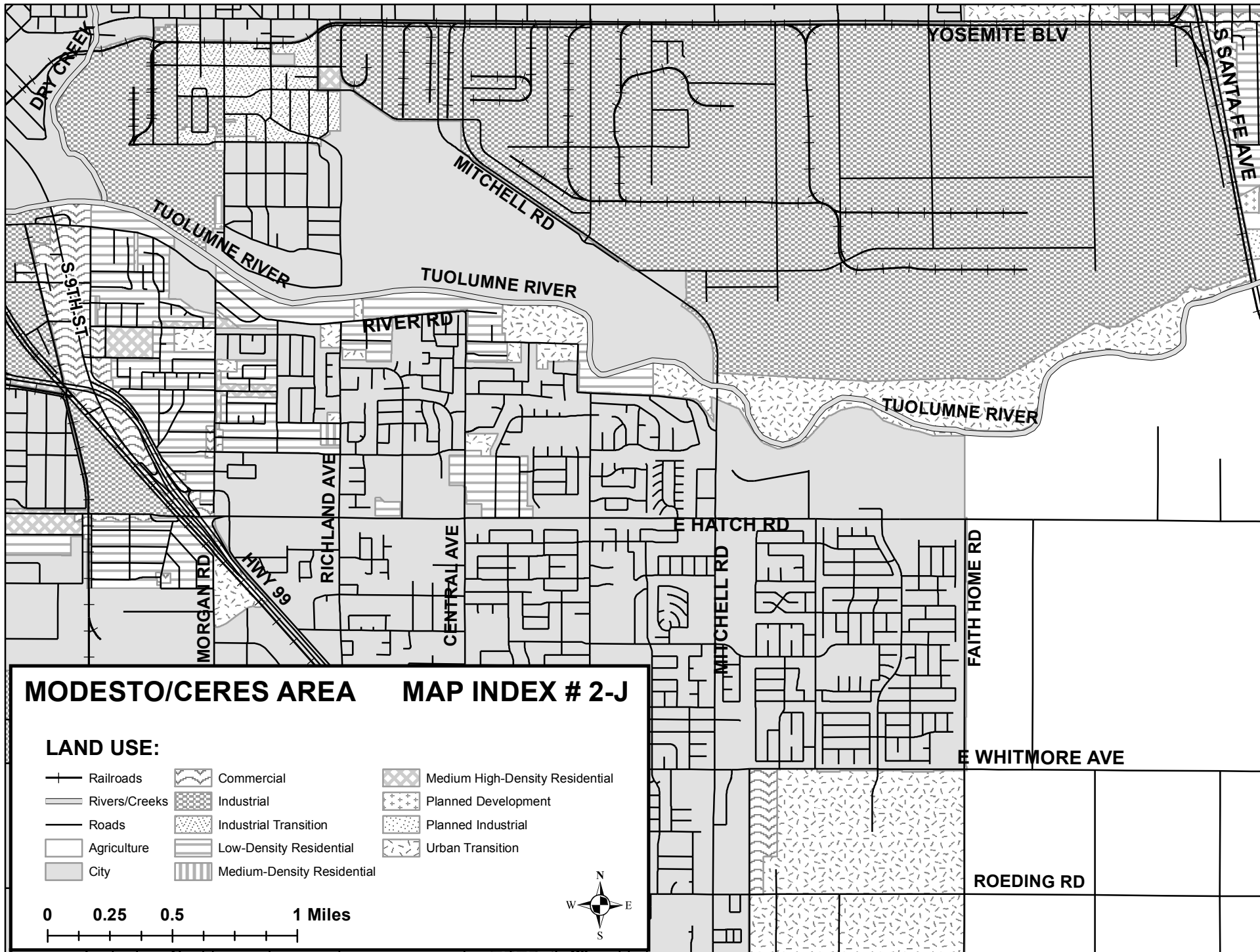

***THIS PAGE INTENTIONALLY LEFT BLANK***



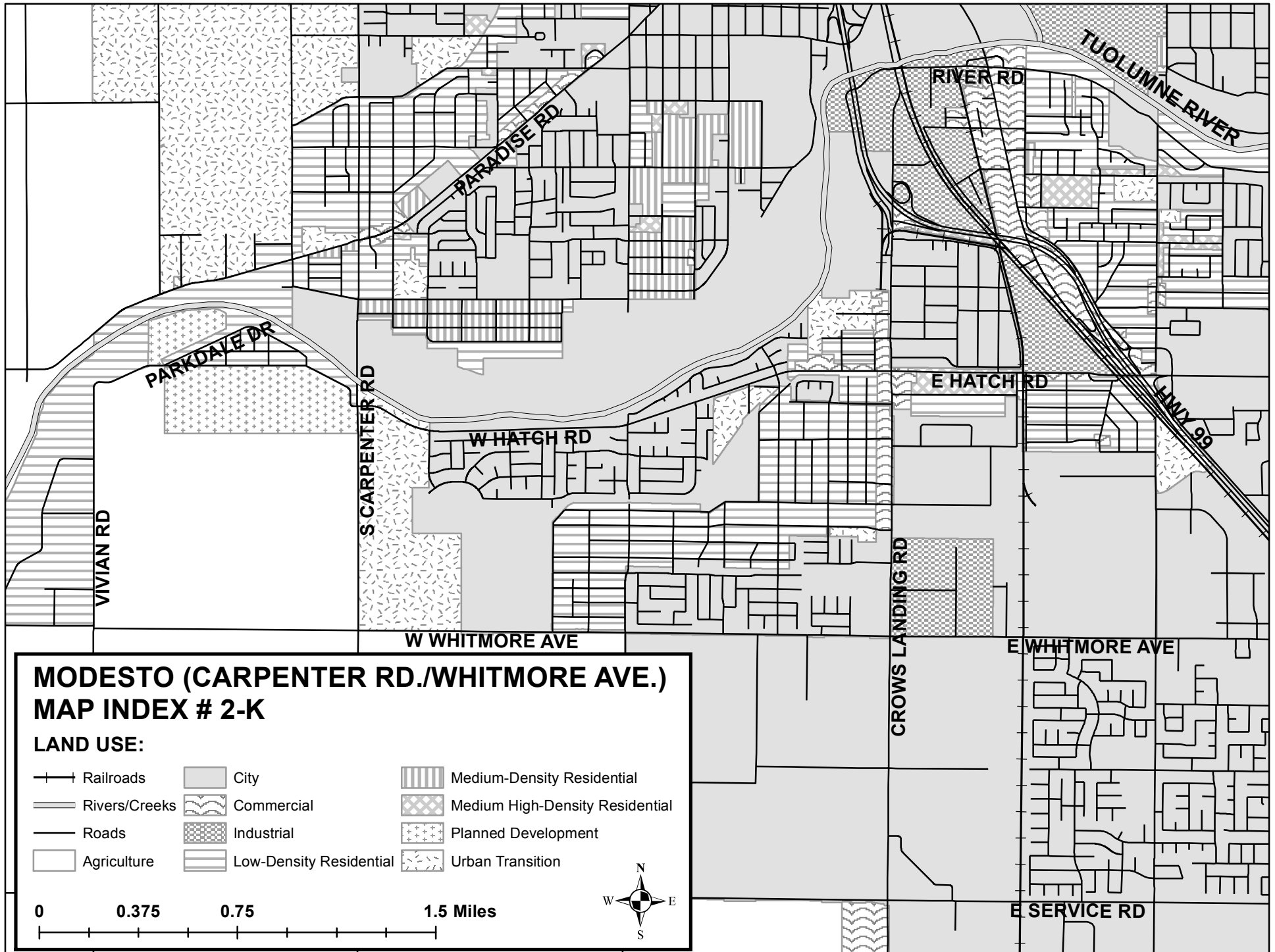

***THIS PAGE INTENTIONALLY LEFT BLANK***

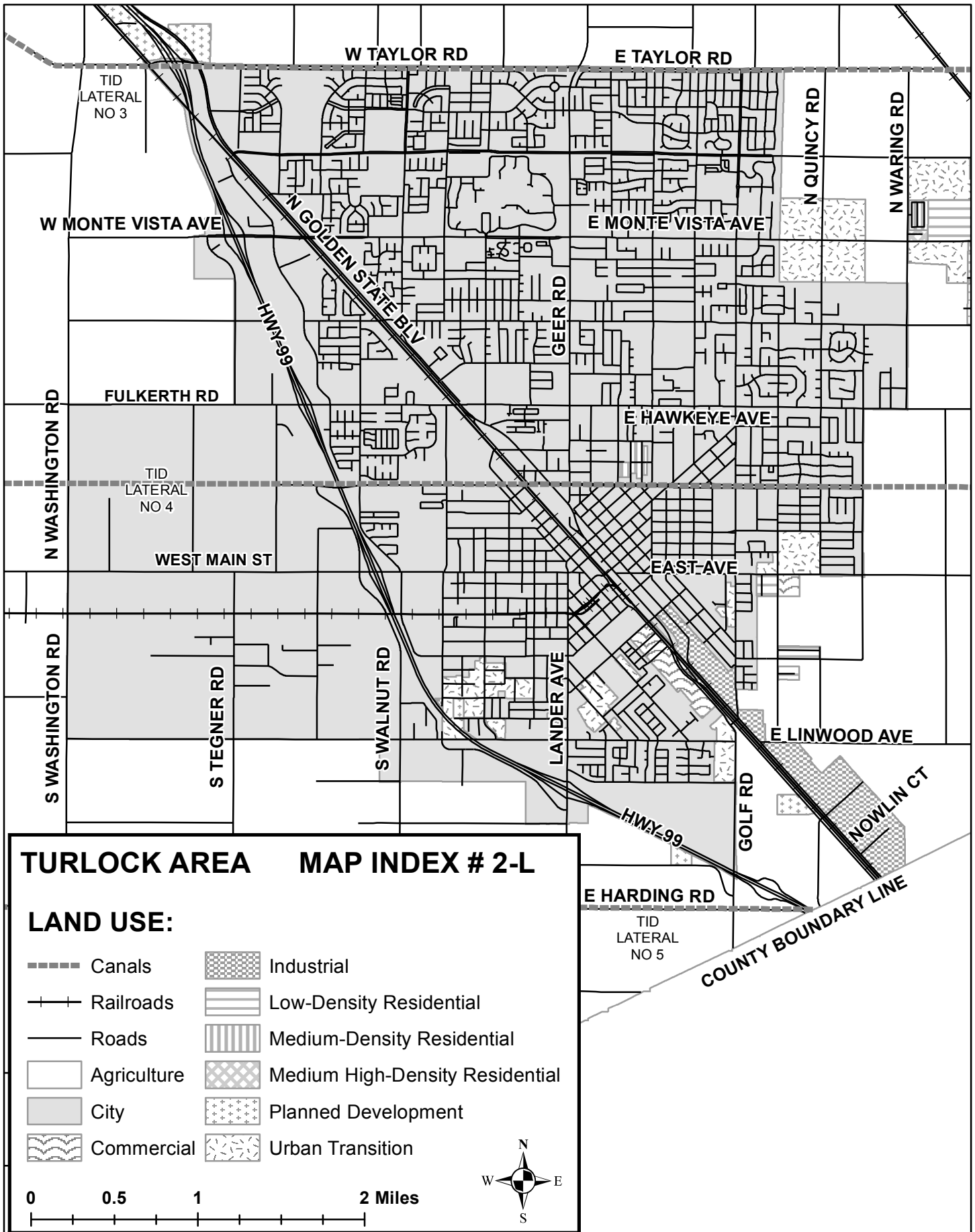

**TURLOCK AREA MAP INDEX # 2-L**

**LAND USE:**

- |               |                                 |
|---------------|---------------------------------|
| ----- Canals  | Industrial                      |
| + + Railroads | Low-Density Residential         |
| — Roads       | Medium-Density Residential      |
| Agriculture   | Medium High-Density Residential |
| City          | Planned Development             |
| Commercial    | Urban Transition                |

0 0.5 1 2 Miles



***THIS PAGE INTENTIONALLY LEFT BLANK***

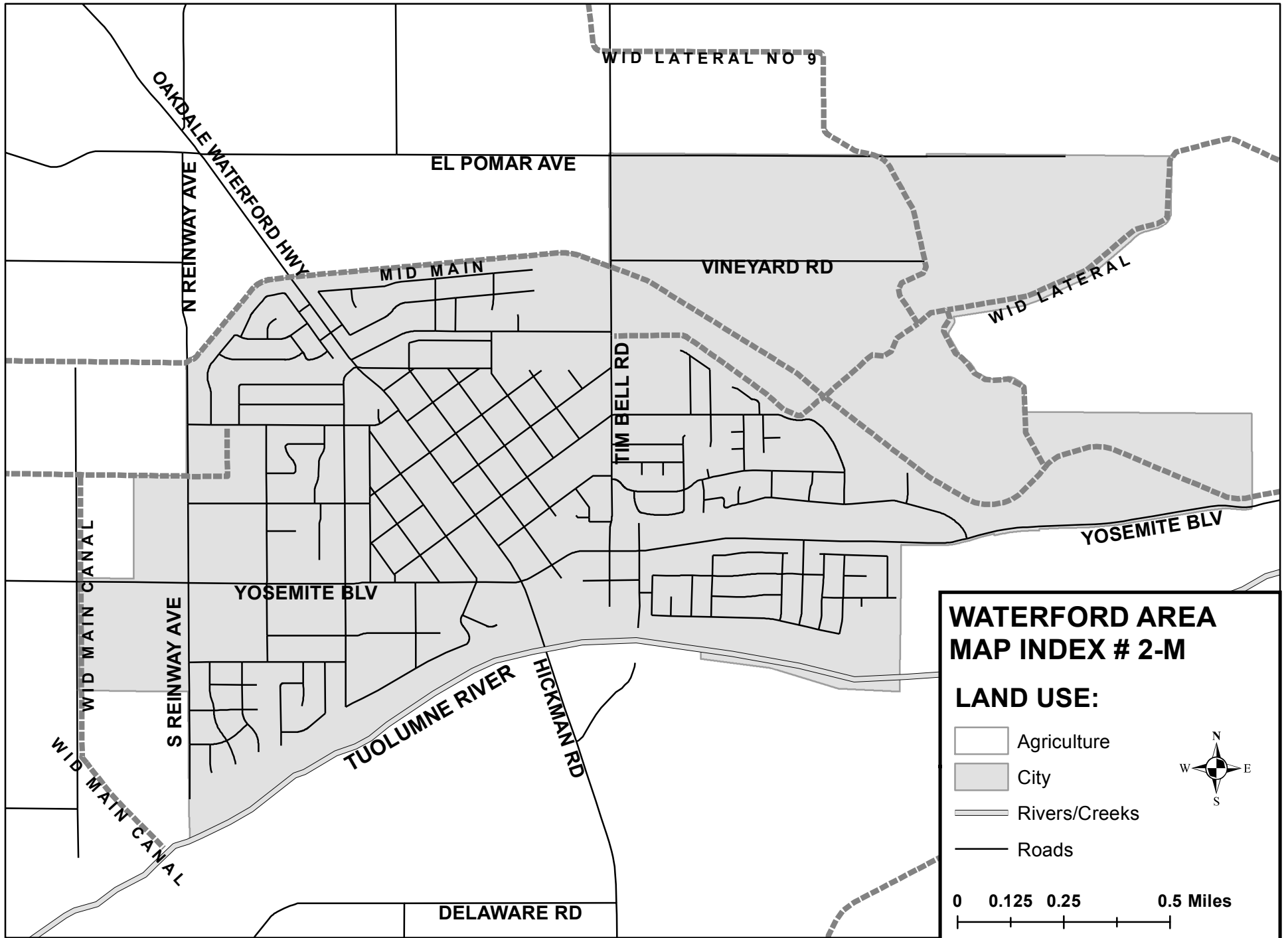

***THIS PAGE INTENTIONALLY LEFT BLANK***

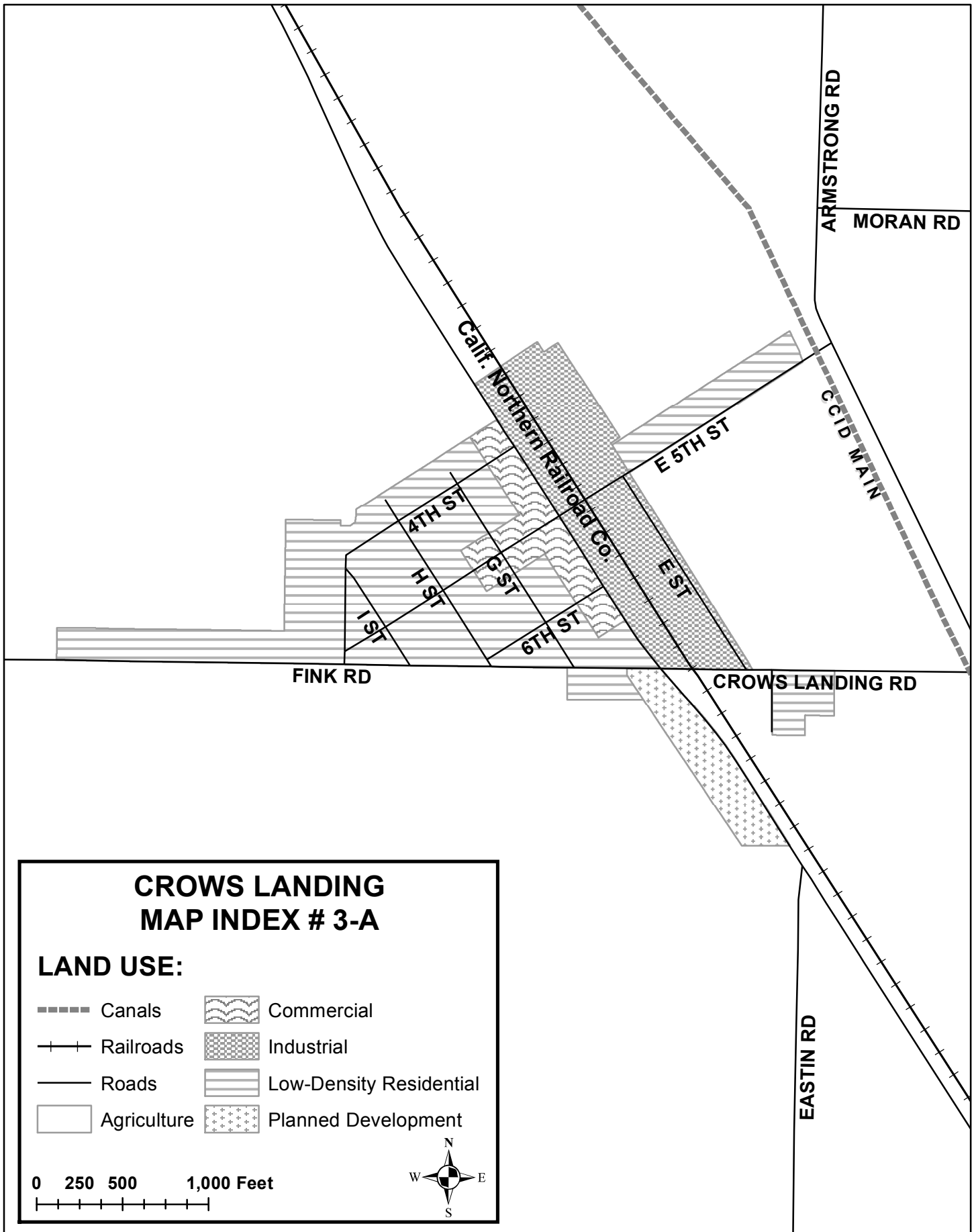

***THIS PAGE INTENTIONALLY LEFT BLANK***



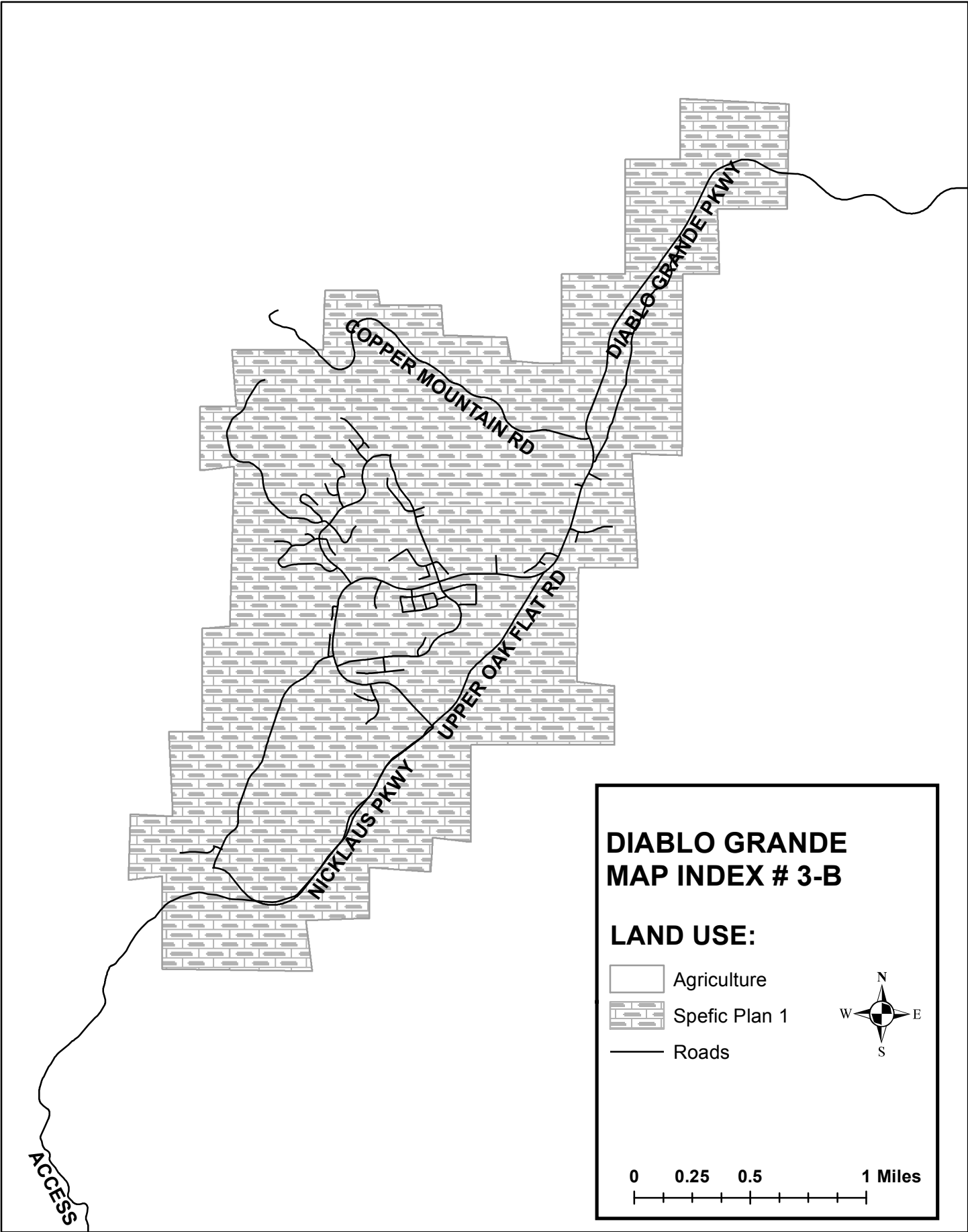

***THIS PAGE INTENTIONALLY LEFT BLANK***

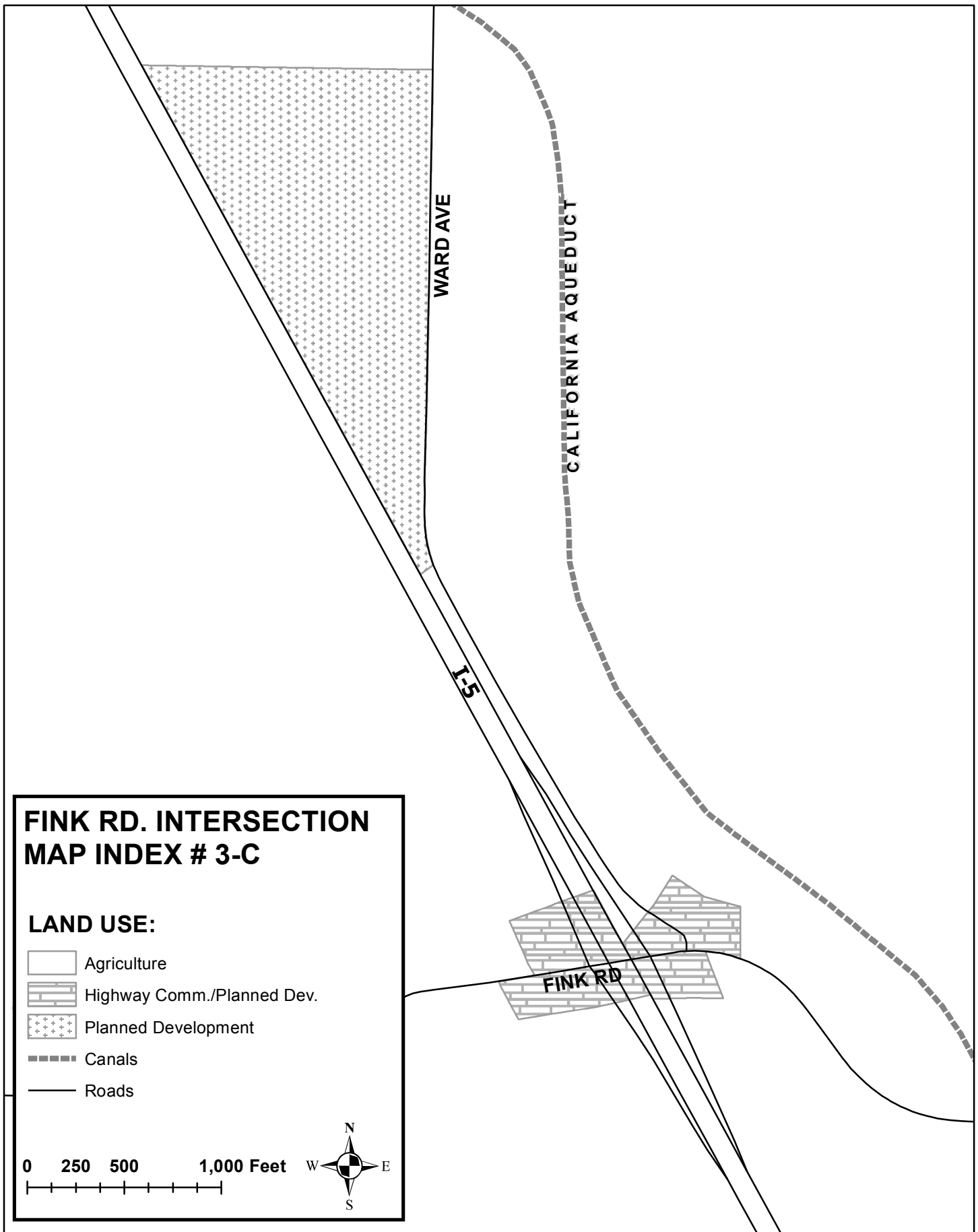

***THIS PAGE INTENTIONALLY LEFT BLANK***

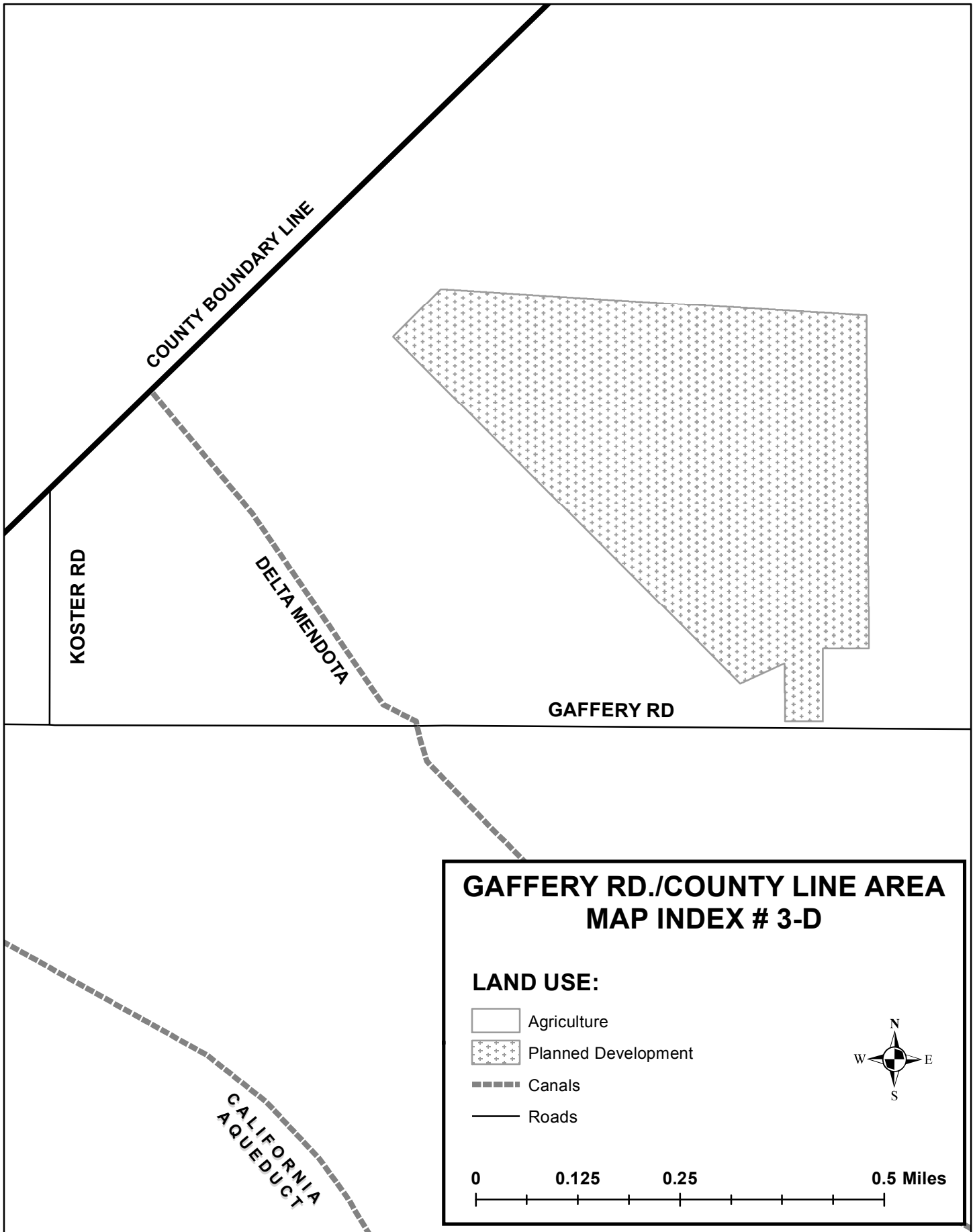

***THIS PAGE INTENTIONALLY LEFT BLANK***

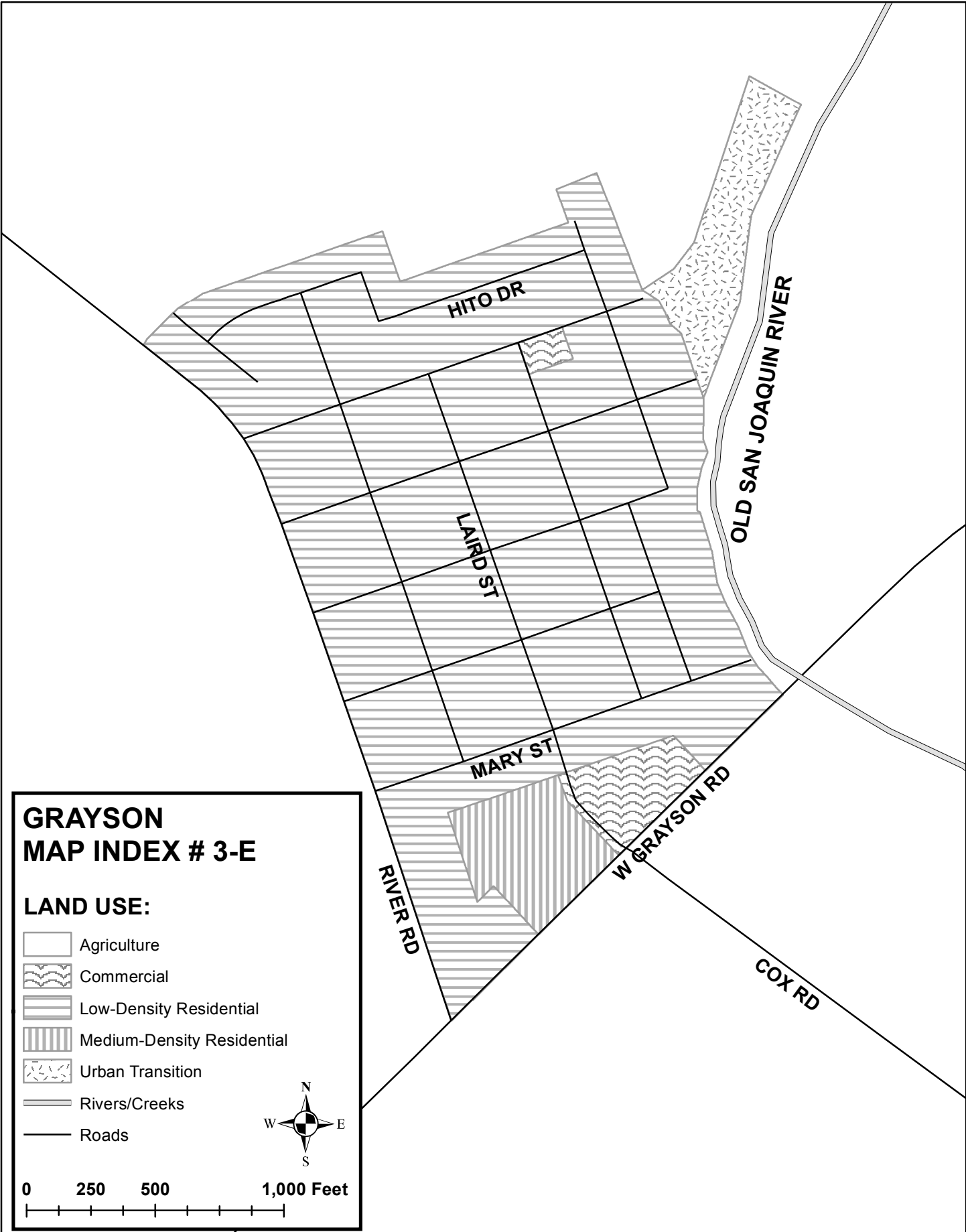

***THIS PAGE INTENTIONALLY LEFT BLANK***



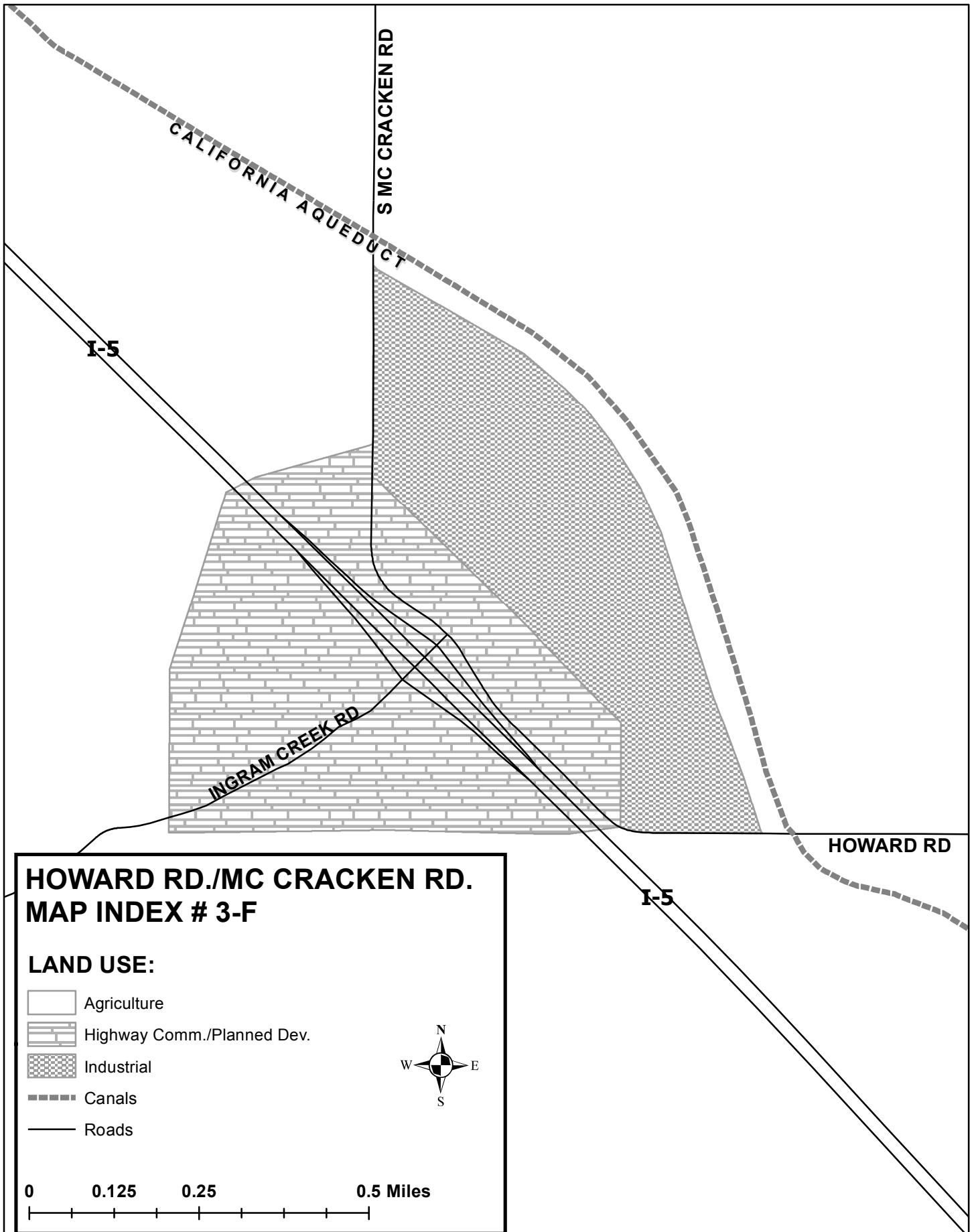

***THIS PAGE INTENTIONALLY LEFT BLANK***

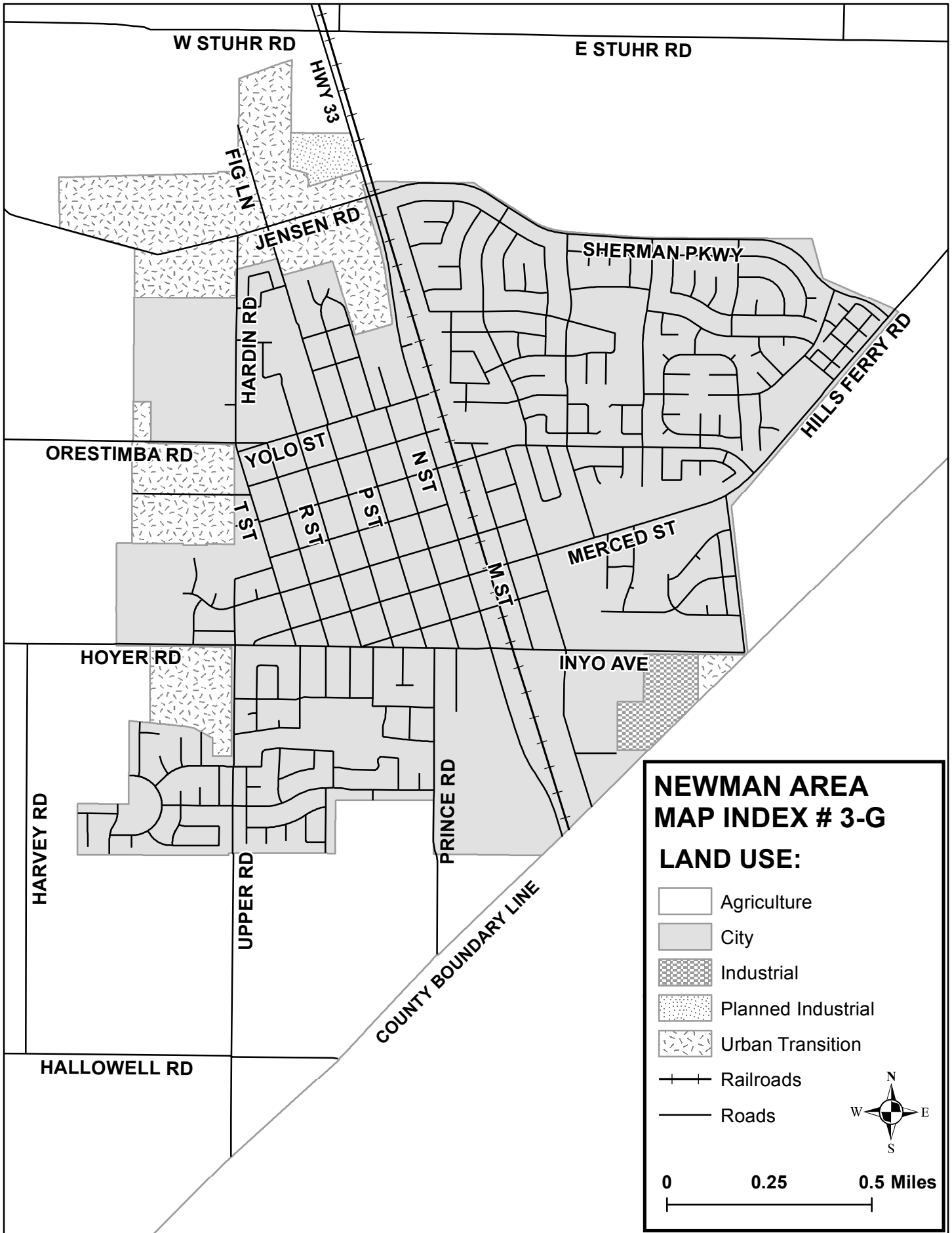

***THIS PAGE INTENTIONALLY LEFT BLANK***

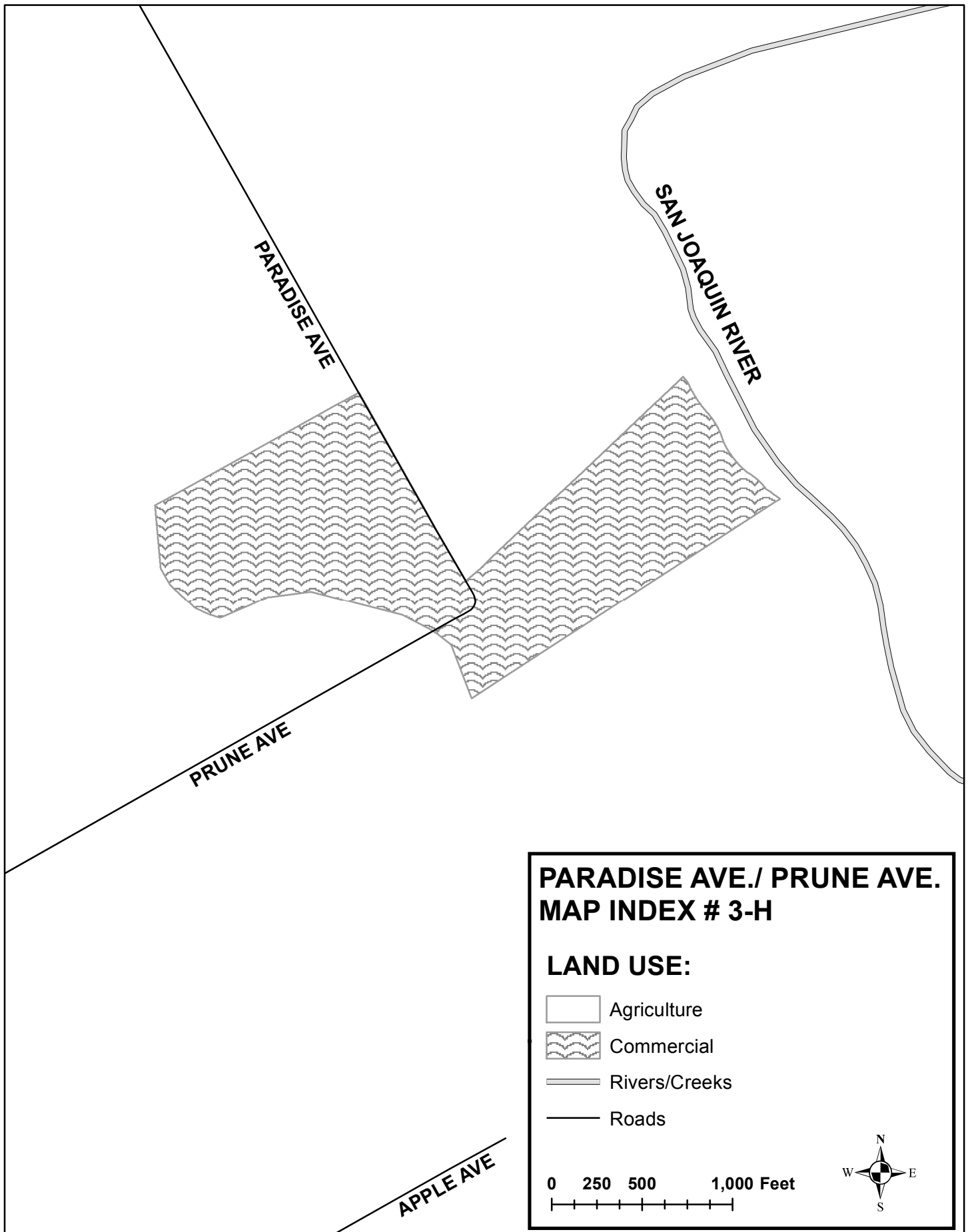

***THIS PAGE INTENTIONALLY LEFT BLANK***

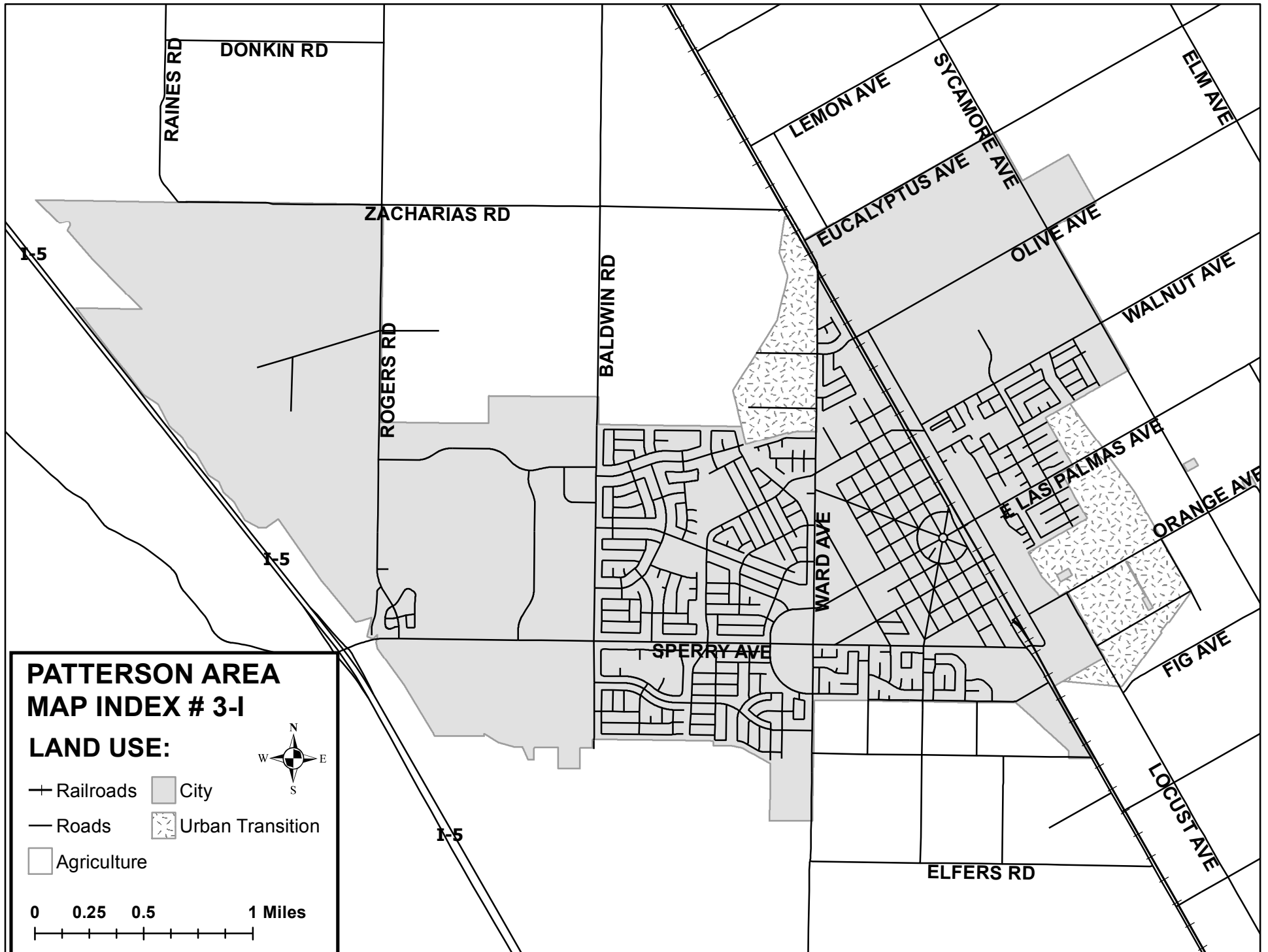

***THIS PAGE INTENTIONALLY LEFT BLANK***



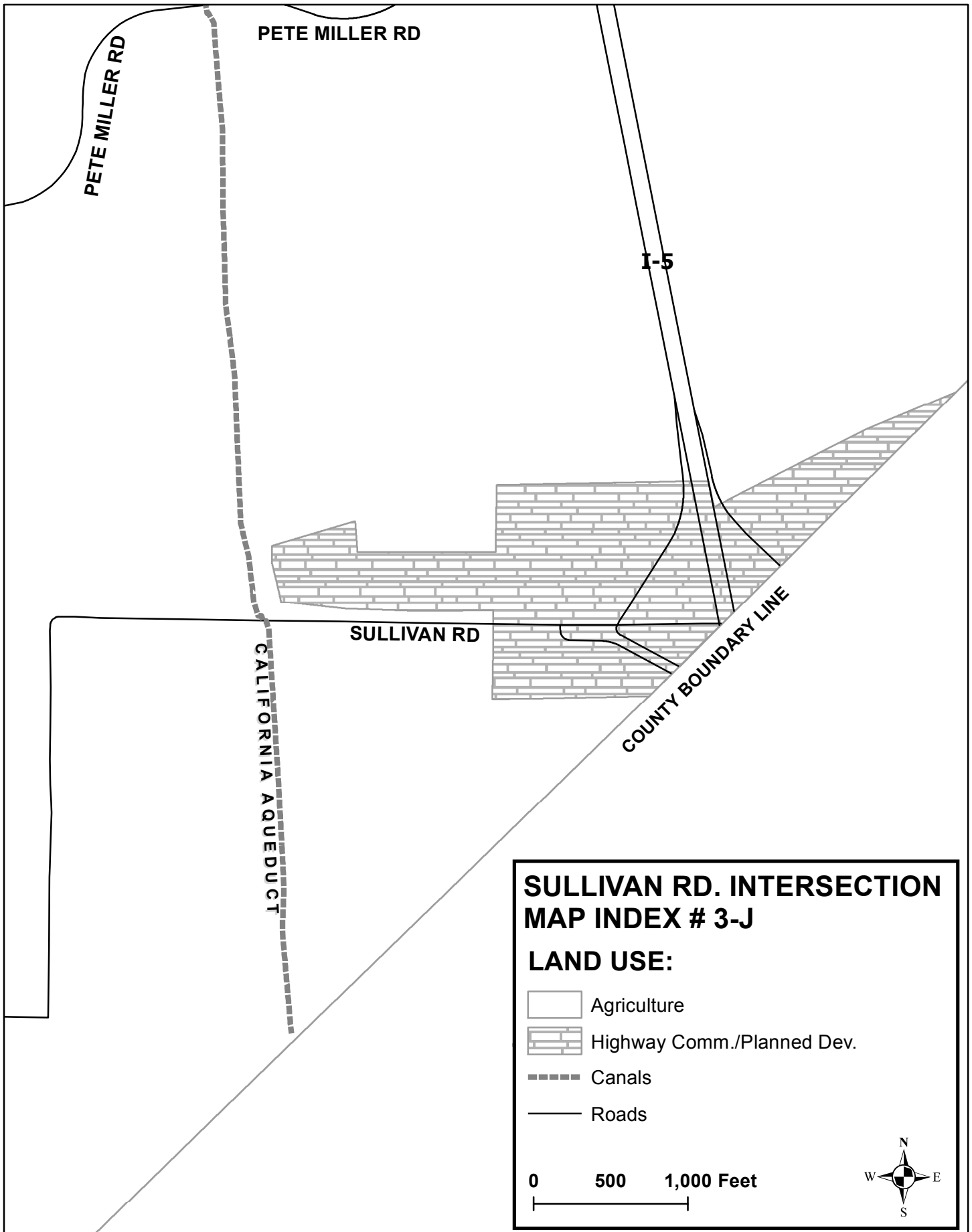

***THIS PAGE INTENTIONALLY LEFT BLANK***

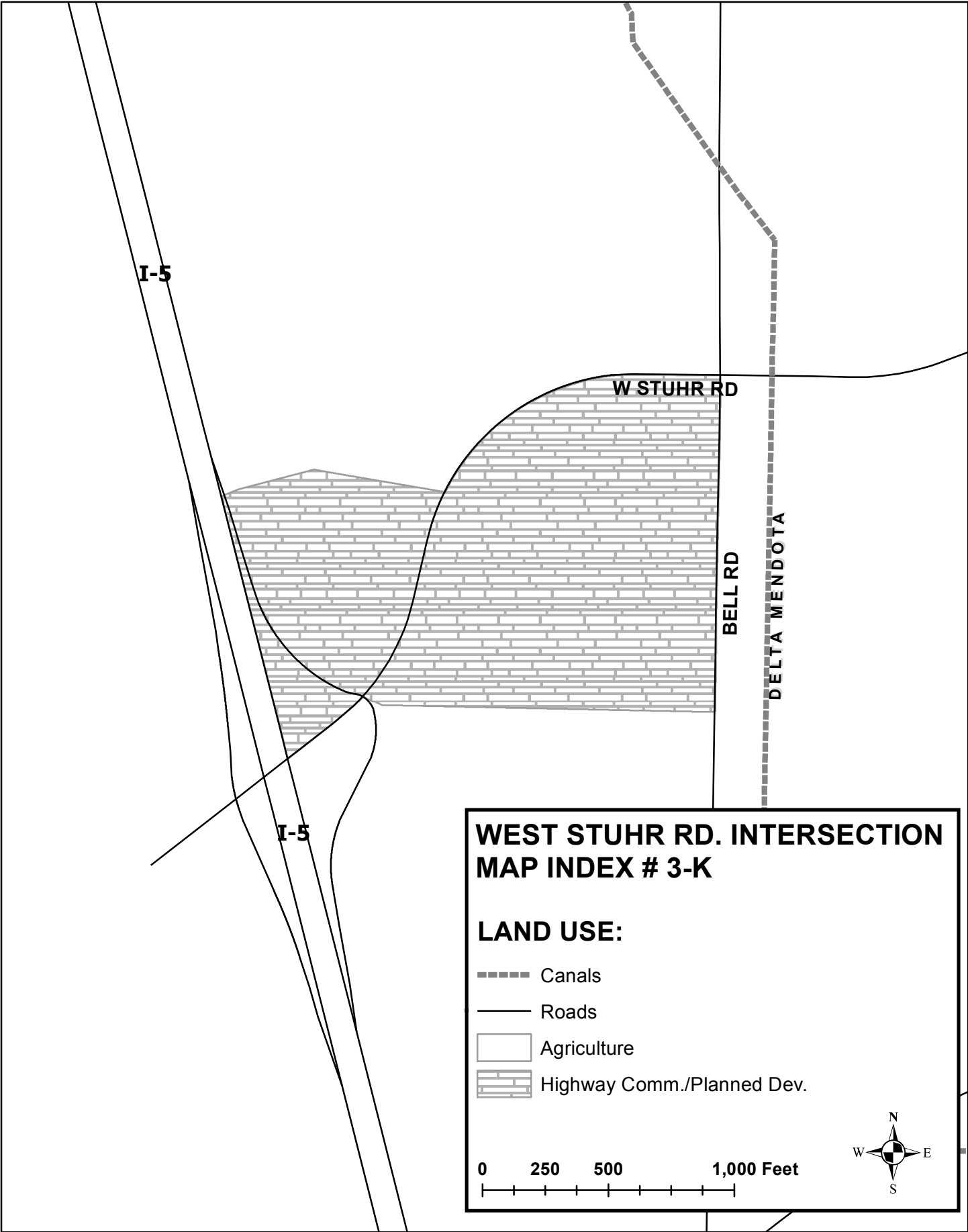

***THIS PAGE INTENTIONALLY LEFT BLANK***

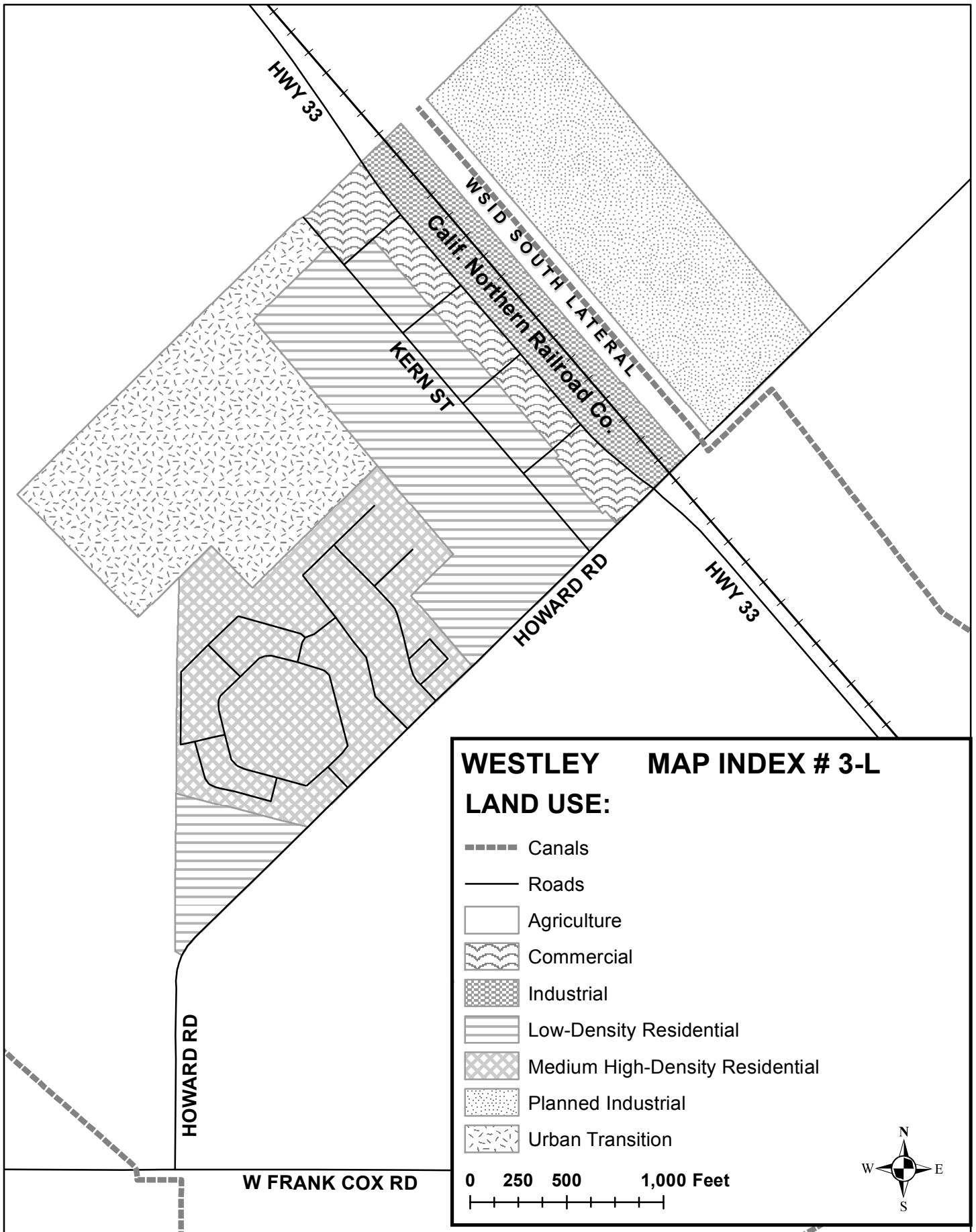

***THIS PAGE INTENTIONALLY LEFT BLANK***

## **PUBLIC FACILITIES AND SERVICES**

### **EDUCATION FACILITIES**

School facilities are provided by 26 school districts in the County. In addition to elementary and high school districts, Stanislaus County has a junior college district and a California State University campus. The Yosemite Community College District supports Modesto Junior College. There are two campuses comprising the college. Modesto Junior College West, located on Blue Gum Avenue, and Modesto Junior College East, located on College Avenue, both within the city limits of Modesto. California State University, Stanislaus is located on West Monte Vista Avenue in Turlock.

The Stanislaus County Office of Education Department of Special Education provides a comprehensive school program for severe and low incidence handicapped students ranging from birth to 22 years of age. The Department provides a variety of education programs and services, including early intervention, K-12 classes for severely handicapped students, specialized student services, and integrated site classes. Alternative Education provides education for students grades 7-12 in the Modesto Community School, Turlock Community School, Juvenile Hall and through independent study programs.

According to the California Department of Education Data Reporting Office, K-12 school districts experienced rapid growth in school enrollment numbers from 2001-2007. As a result, many new facilities and school sites were added to accommodate the rise in student enrollments. That enrollment growth declined in 2008 and has remained steady since. Even with stagnant enrollment numbers and reductions in funding that have occurred over the last five years, school facility expansions and upgrades are still anticipated to occur over the next 20 years.

California State law requires that the Land Use Element of the General Plan address criteria for locating various land uses, including school facilities. Stanislaus County has chosen to meet these requirements through the use permit process. Virtually all County zoning designations, including residential and agricultural zones, allow schools. This method requires a public hearing to be conducted prior to approval unless the school district chooses to ignore these regulations. According to state law, the school district may vote (2/3 vote required) to ignore County zoning regulations (California Government Code Section 53094). This procedure is routinely used by districts in this County with the result that public schools are rarely, if ever, actually subject to the use permit process.

Although school districts usually choose to operate independently of local governmental land use regulations, proposed school sites must be referred to local agencies for comment. In evaluating sites for the location of schools, the County shall consider factors including, but not necessarily limited to, the following:

- a. **Surrounding land uses (both existing and planned).** Existing and future land uses should be consistent with the proposed school facility. Schools shall be located in areas convenient to the people to be served.
- b. **Traffic impacts and public road access.** Proposed school facilities shall not cause significant impacts that cannot be mitigated. School facilities shall be located on collector streets and should not be located on major streets.

- c. **Public safety.** Proposed school facilities shall be located to provide the maximum degree of public safety. They should not be located adjacent to high traffic generating activities.
- d. **Parcel size.** School facilities should be located in areas which are of diminished agricultural importance due to small parcel sizes unless location in other areas are necessary in order to most efficiently serve the public. The typical parcel size for school sites is approximately 10 acres for elementary schools and 40 acres for high schools.
- e. **Impacts on agriculture.** School facilities shall be located to avoid impacts on adjoining agricultural uses. Typically, they should be located within cities or in the Urban Transition area, or in a LAFCO adopted sphere of influence of a city.
- f. **Noise, dust, and vibration.** The proposed school facility shall not cause an unreasonable amount of noise or dust and should not be located in areas where it would be impacted by the same.
- g. **Proximity to an existing or proposed runway.** A proposed school site shall be evaluated by the Caltrans Division of Aeronautics if it is within 2 nautical miles of an existing or proposed runway that is identified in an adopted Airport Layout Plan.

## **PUBLIC BUILDINGS AND GROUNDS**

With the exception of schools as discussed in the preceding section, most public buildings (such as the courthouse, County administration building, city halls, etc.) are located within the limits of incorporated cities. However, there is a lot of public land in the unincorporated part of the County. Most of this land is used for parks or preserved as open space. Lands owned by the United States Government and State of California are used as open space (both existing and future parks) and, in the case of the State, as right-of-way reserved for future construction or expansion of roads.

In addition to identifying existing public buildings and grounds, the Land Use Element is required to designate "the proposed general distribution and general location and extent of the uses of land for . . . public buildings and grounds . . ." (California Government Code Section 65302) Stanislaus County has chosen to permit public buildings and grounds in virtually all of the various zoning districts. Generally, a use permit is required, which allows public review of the request and allows Planning Commission review to ensure suitable locations. This method recognizes the diversity of the areas the plan covers, ranging from residential and commercial neighborhoods to farm and industrial lands. It also recognizes that such facilities could include a variety of uses such as hospitals, office buildings, fire stations, and airports. The permit process allows specific review of the relationships between the proposed uses and those that surround them either currently or in the future. It also allows the County to review the project as it relates to the objectives of this plan. Sites identified on city general plans as being appropriate for public facilities, when within a LAFCO adopted Sphere of Influence, shall be considered consistent with this plan. In some instances, the State or federal law preempts local control and requirements. Therefore, review is only effective when the agency cooperates.

In evaluating the consistency of a public facility, the County shall consider factors including, but not necessarily limited to, the following:

- a. **Surrounding land uses (both existing and planned).** Existing and future land uses should be consistent with the proposed public facility. The facility shall be located in an area that is convenient to the users of the facility.



- b. **Traffic impacts and public road access.** The proposed facility shall not cause significant traffic impacts that cannot be mitigated. In the case of public facilities for open space (wildlife areas, etc.), it is important that traffic not be allowed to impact the open space area.
- c. **Noise, dust and vibration.** The proposed facility shall not cause an unreasonable amount of noise, dust or vibration and should not be located in areas where it would be impacted by the same.
- d. **Public safety.** Proposed public facilities shall be located to provide the maximum degree of public safety.
- e. **Soil types.** Public facilities shall be located as much as possible on poorer soils unless such location is clearly not practical.
- f. **Parcel size.** Public facilities should be located in areas which are of diminished agricultural importance due to small parcel sizes unless location in another area is necessary due to specialized requirements of the facility.
- g. **Impacts on agriculture.** Facilities shall be located to avoid impacts on adjoining agricultural uses.

### **LIQUID AND SOLID WASTE DISPOSAL FACILITIES**

**Solid Waste.** With the passage of the California Integrated Waste Management Act of 1989 Assembly Bill 939 (AB 939), all counties and cities are mandated to provide fully integrated systems to deal with their solid waste. The law requires all communities to reduce the amount of solid waste that goes to disposal by 25% by 1995. That mandate increases to 50% reduction in the year 2000. The County is required to produce a comprehensive planning and implementation document, the Countywide Integrated Waste Management Plan (CIWMP), to guide the County and the incorporated cities in every detail of their solid waste management activities.

The CIWMP provided direction and established goals so the entire community will be assured adequate, long-term disposal capacity. Related to AB 939, annual reports on the County-wide solid waste activities are provided to the State.

**Source Reduction, Recycling, Composting, Environmentally Safe Transformation, and Landfilling.** To enable the County to meet state mandates, the community must have systems and facilities that are not only used for disposal, but also are capable of diverting significant portions of our waste from either landfilling or transformation (waste-to-energy).

Current status: The eleven permitted solid waste facilities in Stanislaus County are described below.

**Fink Road Landfill** – Located at 4040 Fink Road, on the west side of I-5, south of the City of Patterson, in the southwest corner of the County. Owned and operated by Stanislaus County, this facility has a Class III fill operation for general refuse and a Class II monofill used exclusively for ash residual from the waste-to-energy facility.

**Geer Road Landfill** – Located on the west side of Geer Road, on the north side of the Tuolumne River, north of the City of Hughson. This facility is no longer receiving waste and is going through extensive state-mandated post-closure activities. The facility is owned by

Stanislaus County and the City of Modesto; Stanislaus County is performing the closure activities.

**Bonzi Landfill** – Located at 2650 W. Hatch Road., west of Carpenter Road, just west of the City of Modesto. This facility, although presently inactive, was considered to be a Class III landfill permitted to receive specified inert and industrial wastes. Owned and operated by a private company.

**Stanislaus Resource Recovery Facility** – Located on Fink Road, adjacent to the Fink Road Landfill, on the west side of I-5, south of the City of Patterson, in the southwest corner of the County. This is an 800-ton-per-day, mass-burn, waste-to-energy facility. Electricity is generated and sold to a public utility. Owned and operated by a private company.

**Waste Management, Inc. Transfer Station** – Located at 2769 W. Hatch Road, west of Carpenter Road, west of the City of Modesto. A large volume transfer station permitted to receive general waste and recyclables from residential, commercial and industrial sources. Owned and operated by a private company; however, it is currently inactive.

**Turlock Transfer** – Located at 1100 South Walnut Road, inside the City of Turlock, on the west side of State Highway 99. Large-volume transfer station permitted to receive general waste and recyclables from residential, commercial and industrial sources. Owned and operated by a private company.

**Bertolotti Transfer and Recycling Center** – Located at 231 Flamingo Drive, on the northeast corner of Crows Landing and E. Whitmore Roads, in the Modesto area. Large-volume transfer station permitted to receive general waste and recyclables from residential, commercial and industrial sources. Owned and operated by a private company.

**Gilton Resource Recovery/Transfer Facility** – Located at 800 S. McClure Road, in the Beard Industrial Area, south of the City of Modesto and north of the City of Ceres. Owned and operated by a private company, this large-volume transfer station is permitted to receive general waste and recyclables from residential, commercial and industrial sources.

**Recology Grover Environmental Products** – Located 6131 Hammett Road, in the Salida Community Area, west of State Highway 99. Owned and operated by a private company. This Composting facility is permitted to receive green waste.

**Recology Blossom Valley Organics** – Located at 3909 Gaffery Road, in the west side of the County, east of Interstate 5. Owned and operated by a private company. This Composting facility is permitted to receive mixed green waste and limited non-contaminated post-consumer food waste.

**City of Modesto Co-Compost Project** – Located at 7001 Jennings Road on the northeast side of the City of Patterson. Owned and operated by the City of Modesto. The co-composting facility is permitted to compost food waste, green materials and bio-solids.

A majority of the collection and removal of garbage and refuse in the County is performed by franchised and permitted waste haulers. Private individuals can use any of the facilities except the Geer Road Landfill, which is closed, and the waste-to-energy facility, which restricts access to non-permitted haulers.

Recovery of recyclable and reusable materials takes place at each of the transfer stations. In addition, all of the franchised refuse haulers in the County operate systems for the curbside collection of recyclables on their residential routes.

Future perspective: Stanislaus County will continue to take a very active role in all aspects of solid waste management. Medium and long-range plans will incorporate both future landfill capacity and diversion facilities. Projects like composting operations and material recovery facilities need to be planned for and encouraged. Facilities and projects that deal with the diversion of special wastes (food processing residue, demolition/construction waste, inert wastes, tires, de-watered sewage sludge and household hazardous wastes) should be allowed to continue and expand as justifiable.

It is imperative that both existing and potential disposal and diversion facilities are protected, thereby, assuring proper opportunities for their continued use, expansion or development. The County will ensure that no new uses that conflict with solid waste facilities are permitted next to, or near, such sites.

***Responsible Departments: Environmental Resources, Board of Supervisors***

**Liquid Waste.** Liquid waste facilities (sewer plants) are located throughout the County. Each of the incorporated cities has its own facilities as do the unincorporated communities of Grayson and Salida. The Stanislaus County Housing Authority owns the system which serves Westley. The towns of Keyes and Denair use Turlock's facilities and Empire uses Modesto's. Nearly all of the cities facilities are within the limits which they serve (six of nine) although all but one of these facilities is surrounded on at least three sides by County land. Riverbank's plant is in San Joaquin County. Modesto's plant is partly inside the City and partly outside. Only Waterford's facilities are located totally in the County. In addition to incorporated towns, the systems which serve Grayson, Salida, and Westley are located in the County.

Liquid waste facilities are permitted only in the A-2 (General Agriculture), PD (Planned Development) and M (Industrial) zoning districts. In all three districts, public hearings are required in order to approve the project, thereby assuring proper opportunities for complete review.

***Responsible Departments: Environmental Resources, Planning, Planning Commission, Board of Supervisors***

***THIS PAGE INTENTIONALLY LEFT BLANK***

## **AREAS SUBJECT TO FLOODING**

There are a number of areas within Stanislaus County which are subject to periodic flooding. They are located along the natural watercourses. These include the County's three major rivers: the Stanislaus, the Tuolumne, and the San Joaquin. Several creeks are subject to flooding as well: Salado, Del Puerto and Orestimba west of the San Joaquin River; and Dry Creek, Little John Creek, and Sand Creek on the east side of the County. The Farmington Flood Control Basin located on Little John Creek in the northeasterly part of Stanislaus County floods periodically in order to protect lands downstream. In addition, all of the creeks flowing out of the Diablo Mountains should be considered potentially flood prone.

The County has recognized the need to plan and protect its residents as much as possible from flooding hazards. The County adopted its Flood Damage Prevention Ordinance in 1996. It makes reference to the flood hazard areas which have been identified by the Federal Insurance Administration (FIA) of the Federal Emergency Management Agency (FEMA). The County has adopted that agency's Flood Insurance Rate Maps (FIRMs), Flood Boundary and Floodway Maps (FBFMs) and has adopted specific regulations pertaining to building activities within those areas. Detailed maps are available in the County Department of Planning and Community Development - Building Permits Division. The subject of flooding is discussed extensively in the Safety Element.  
***Responsible Departments: Public Works, Planning, Board of Supervisors***

***THIS PAGE INTENTIONALLY LEFT BLANK***

## **COMMUNITY PLANS**

Stanislaus County has adopted Community Plans for most of the unincorporated communities in the County, with the exception of Empire, Grayson, and Valley Home. The Community Plans (text and land use maps) are included as appendices to the Land Use Element. These plans outline the future growth pattern of the communities. Each plan is used in conjunction with the General Plan to indicate whether areas will be residential, commercial, industrial, etc. Any requests for rezoning of property located within a Community Plan must be consistent with the Community Plan.

### **POLICIES FOR DEVELOPMENT**

A request for development within a Community Plan area, exceeding the property's existing development rights, shall include a request to change the General Plan and/or zoning designation of the property, and, if necessary for development, subdivide the property. The County will review the application for consistency with the adopted Community Plan. Any amendment to a Community Plan shall be processed as a General Plan amendment.

### **GENERAL PLAN (COMMUNITY PLAN) DESIGNATIONS**

The Land Use Element of the General Plan lists all of the land use designations used in the County. These same designations will be used in the Community Plans. Occasionally, circumstances applicable to a particular community or situation may warrant a slightly different description or additional refinement of the designation. Only in this type of instance will the designations be further described in individual Community Plans. Unless so specified, the designations and their compatible zoning designations listed in the Land Use Element shall govern.

In circumstances where the circulation/transportation designations/roadway classifications of a Community Plan are not consistent with those of the Circulation Element of the General Plan, the Circulation Element designation/classification, shall govern unless determined otherwise by the Director of Public Works.

***THIS PAGE INTENTIONALLY LEFT BLANK***



## LAND USE ELEMENT

### APPENDICES

#### **Appendix I-A**

##### Community Plans

1. Crows Landing
2. Del Rio
3. Denair
4. Hickman
5. Keyes
6. Knights Ferry
7. La Grange
8. Salida
9. Westley

#### **Appendix I-B**

##### Historical and Design Standards

1. Knights Ferry Historical Standards
2. La Grange Historical Standards
3. Salida Design Standards

#### **Appendix I-C**

##### Planned Development Area Specific Resolutions

1. Resolution No. 87-1 – Upper McHenry
2. Resolution No. 87-3 – Freeway Interchange and Frontage Roads adjacent to major highways and freeways

#### **Appendix I-D**

Stanislaus County Disadvantaged Unincorporated Communities Report – November, 2015

***THIS PAGE INTENTIONALLY LEFT BLANK***

# Appendix I-A1

## CROWS LANDING COMMUNITY PLAN

Adopted by the Stanislaus County Board of Supervisors

JUNE 23, 1987\*

*\*A technical update to population statistics, service providers, and conditions in and surrounding the community were adopted on August 23, 2016, as part of the 2015 comprehensive General Plan Update. The 2015 update also incorporated into the Community Plan information from the June 23, 1987, adopted Support Documentation to the Stanislaus County General Plan.*

***THIS PAGE INTENTIONALLY LEFT BLANK***

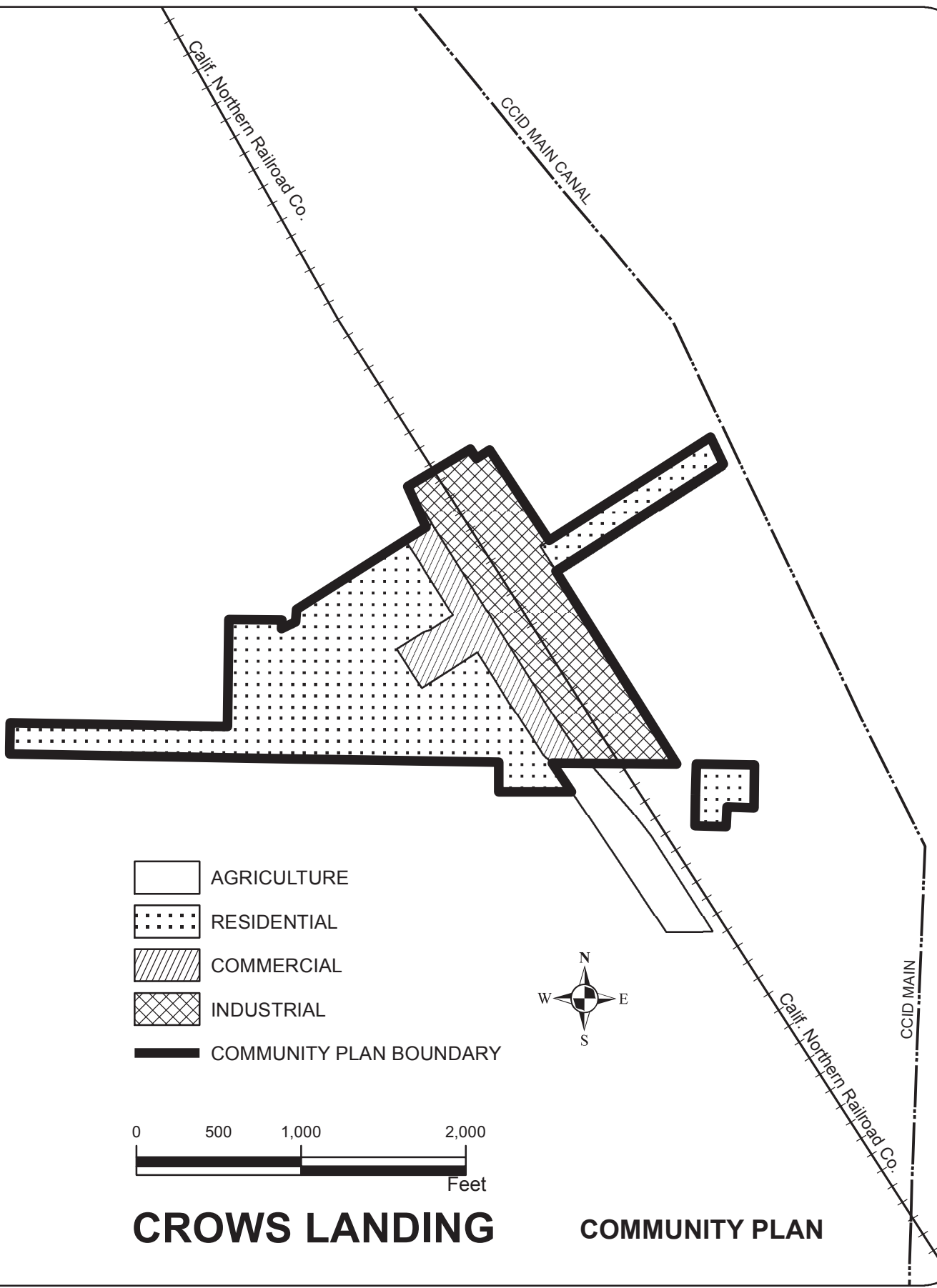

# CROWS LANDING

# COMMUNITY PLAN

***THIS PAGE INTENTIONALLY LEFT BLANK***

## **Description of Crows Landing**

The community of Crows Landing is located on the west side of Stanislaus County, straddling State Highway 33. Approximately one and one-half miles to the northwest of the town is the former United States Naval Auxiliary Landing Field, Crows Landing, which previously served as a practice landing field for Navy, Marine, and NASA Research aircraft. The United States Congress conveyed the former military property to Stanislaus County in 2004 pursuant to Public Law 106-82. Since that time, the County has embraced the opportunity to revitalize the County's economy through the reuse of the former airfield to the benefit of County residents and the region as a whole. Conveyance of the remaining 176 acres is anticipated to occur pending remediation. The community of Crows Landing is located within an area of long-standing, intense agricultural uses.

## **History**

Transportation has played a major role in shaping the history of Crows Landing. Crows Landing was established in the 1850's as a ferry landing on the San Joaquin River for gold miners destined for the Mother Lode. After the initial gold rush was over, Crows Landing became a river port for steamers hauling agricultural goods produced in the area to market. But in 1888 when the railroads arrived offering more reliable service than the river steamers could provide, the whole town moved to its present location adjacent to the railroad tracks three miles west of its original site.

## **Land Use**

The community of Crows Landing consists primarily of single family homes. Along Highway 33 and the Southern Pacific Railroad Tracks are many agricultural warehouses and packing sheds. On the west side of Highway 33 and along 5th Street from halfway between G and H Streets to the highway is the commercial area of Crows Landing. The commercial and industrial areas serve both the community of Crows Landing and the surrounding agricultural area. The community is surrounded by land under Williamson Act contract. There are only a few large parcels not under contract.

## **Available Urban Services**

The West Stanislaus Fire Protection District provides fire protection services and the Stanislaus County Sheriff's Department provides police protection. The Crows Landing Community Service District provides public water but there is no sanitary sewer system. The District provides municipal water services for residential and commercial purposes via two groundwater wells. Currently, the majority of the municipal water is pumped through very old and small pipelines, which tend to lose pressure when heavy consumptive demands are placed on the system. The system is also at capacity, limiting the District's ability to expand.

## **Transportation**

Highway 33 bisects the town of Crows Landing. Interstate 5 is only 3 miles to the west and can be reached via Fink Road and the Fink Road interchange. The Southern Pacific Railroad lines run parallel to Highway 33.

## **Development Potential**

The estimated population in Crows Landing in 2014 was 500 residents. It is not anticipated that Crows Landing will experience significant growth in the coming years. Constraints with the existing water system, lack of sanitary sewer and existing Williamson Act contracts will keep its growth to a minimum.

***THIS PAGE INTENTIONALLY LEFT BLANK***



## **Appendix 1-A2**

# **DEL RIO COMMUNITY PLAN**

Adopted by the Stanislaus County Board of Supervisors

AUGUST 1992\*

*\*An update to the Community Plan map to reflect previously approved amendments to the Community Plan were adopted on August 23, 2016, as part of the 2015 General Plan Update.*

***THIS PAGE INTENTIONALLY LEFT BLANK***

## TABLE OF CONTENTS

I.	INTRODUCTION.....	I-87
II.	GOALS AND POLICIES.....	I-89
III.	LAND USE PLAN.....	I-91
IV.	CIRCULATION PLAN.....	I-98
V.	INFRASTRUCTURE SYSTEM.....	I-100
VI.	IMPLEMENTATION PROGRAMS.....	I-101

## LIST OF EXHIBITS

Del Rio Community Plan.....	I-86
Existing Land Use.....	I-93
Flowage & Fish & Wildlife Easement.....	I-96
Circulation Plan Map.....	I-99

***THIS PAGE INTENTIONALLY LEFT BLANK***

# DEL RIO COMMUNITY PLAN

## AREA I

- APPROVE GENERAL PLAN AMENDMENTS
- REQUIRE PLANNED DEVELOPMENT
- REZONING ON NEW PROJECTS
- REQUIRE PROJECTS TO CONFORM TO AIR QUALITY / WATER MITIGATION MEASURES
- GENERAL PLAN DESIGNATIONS: LOW DENSITY RESIDENTIAL AND AGRICULTURE

## AREA II

- GENERAL PLAN AMMENDMENTS POSTPONED UNTIL A DETAILED STUDY IS PREPARED OF WATER / AIR / AGRICULTURAL BUFFERING / CIRCULATION AND COMMUNITY SERVICES ISSUES
- GENERAL PLAN DESIGNATIONS: AGRICULTURE / SPECIFIC PLAN OVERLAY

### Legend:

- AREA I
- AREA II
- ▨ Stanislaus River
- Del Rio Parcels
- +— Railroad

### Community Plan Land Use Designations:

With residential densities by Sub Area: Dwelling Units (DU) per Acre (AC)

- ▨ Recreation: No Residential Density
- ▨ Open Space: No Residential Density
- ▨ Ag Use: No Residential Density
- ▨ Commercial: No Residential Density
- Sub Area 2: 2 DU / 1 AC
- ▨ Sub Area 3: 1 DU / 1 AC
- ▨ Sub Area 4: 1 DU / 2 AC
- ▨ Sub Area 5\*: 4.5 DU / 1 AC

\*Approved August 28, 2012 as GPA # 2012-447

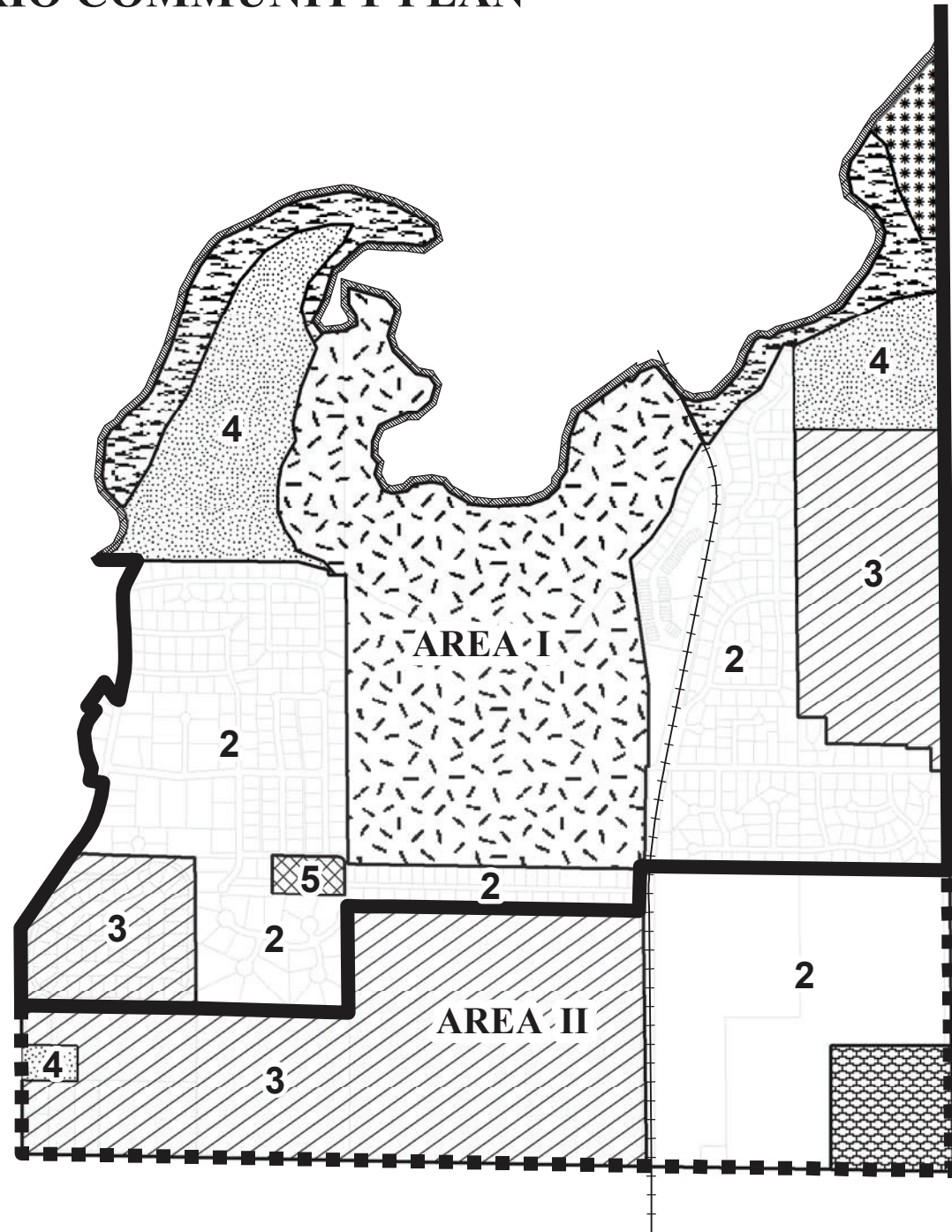

***THIS PAGE INTENTIONALLY LEFT BLANK***

## I. INTRODUCTION

A community plan is a focused planning policy and land use planning document that is part of the General Plan. It addresses a particular region or community within the overall planning area.

Community plans provide means for resolving local conflicts where there are a variety of distinct communities or regions deserving special attention. The plan must be consistent with the General Plan as it is actually a part of the County General Plan.

In February 1990, the Stanislaus County Department of Planning and Community Development initiated an update of the Del Rio Community Plan. This plan was originally adopted in 1980, and the findings and recommendations of the plan were primarily a reflection of the County's policy of preserving prime agricultural land and the sentiment of the Del Rio residents, who were overwhelmingly in opposition to large scale development in the area. The passing decade has seen continued pressure for additional development in this area.

The County subsequently contracted with the planning firm of STA, Inc., to prepare an EIR and develop an updated Del Rio Community Plan. Financial support for this project was obtained from three developers who had already proposed developments on three sites in Del Rio.

Updating the Community Plan required input from existing residents of Del Rio. To a limited degree, this was accomplished through a Scoping Meeting. At this meeting STA presented four different proposals to solicit input as to a 'preferred' plan. It was apparent from this meeting that, though many residents were inclined to resist substantial increases in residential development in Del Rio, there was no clear consensus of how much additional development was desired. An EIR was prepared which analyzed the impact of the full build-out option and two alternative proposals with less development. The Del Rio Property Owners Association then sent out a questionnaire to property owners to assess the community's preferences and their support for a Community Services District. More than 70 percent of the residents responding to this questionnaire indicated their preference for Alternative A, the proposal with the least amount of residential development. Only 18 percent supported the full buildout plan alternative. An ALTERNATIVE DEL RIO COMMUNITY PLAN, prepared by R. Myles Riner and Jamie Aggers, was presented to the Planning Commission and the Board of Supervisors in November and December of 1990. This plan was based in part on the responses to the questionnaire, and on the analysis of the EIR which indicated that Alternative A was environmentally superior to the other two alternatives. At the December Board meeting it became apparent that the EIR project was incomplete.

The Board of Supervisors returned the Del Rio Community Plan and EIR to the Planning Department for further review of additional information which had not been available to the Commission. Subsequently, additional reports from Geological Technics, Inc. and Simons and Associates on the geologic, hydrologic, and environmental impacts of development in the Del Rio area were received, and an analysis of this report by the Department of Environmental Resources was made available. An Air Quality Impact Report by Earthmetrics was also

circulated for review. These reports and subsequent DER and Air District analysis have been incorporated into the plan EIR. The EIR serves to analyze the impacts of this current Del Rio Community Plan. It is, however, insufficient to address the cumulative impacts of development in Area II on the entire Del Rio area. This current plan has evolved from all aspects of the lengthy Community Plan basis, but is based in large part on the Alternative Draft Community Plan document.

This Community Plan proposes development of the Del Rio area as a mixed residential, recreational, and agricultural community with residential, natural open space/recreational, and agricultural use **which consist with and would maintain the essential character of the existing community.** Future residential uses would continue the low-density development already present, and would be incorporated gradually over the next 12-15 years. Recreational uses would be expanded through the designation of natural open space; incorporation of recreational and/or open areas in future development; and, at the discretion of the Del Rio County Club and the County, expansion of the golf course. Agricultural use would be gradually confined to the southern portion of the community, with efforts made to decrease the incompatibility impact of adjacent agricultural and residential uses.

Further development of property in Del Rio beyond that indicated for Area I of this Community Plan could gradually change the essential character of the community, result in significant impact on the present community, and substantially increase the services and facilities needed to support the community. No such development should be approved unless and until a detailed study is first conducted which addresses the cumulative impact of this additional development on the entire Del Rio area. Development of land in Area II would require the development and approval of a Specific Plan which encompasses all of Area II, and which provides full mitigation of the impacts identified in the updated EIR and in this plan. In addition, no such development should be approved unless and until a referendum of the existing residents of the Del Rio community is conducted to determine if there is community support to finance (if this would be required of current residents) any of the necessary mitigation measures for additional services and facilities required. The specific plan shall address this issue in more detail.



## **II. GOALS AND POLICIES**

It is the purpose of this section to state overall goals and policies adopted by the County Planning Commission and the Board of Supervisors concerning growth and land use in the Del Rio area. These statements listed below are official goals and policies of Stanislaus County with respect to the Del Rio area.

### **GOAL 1**

Future development should occur in an orderly manner to meet the needs of existing and future residents.

#### **POLICY A**

Until otherwise updated or amended, future development for Del Rio shall take place in accordance with the Community Plan.

### **GOAL 2**

Prime agricultural land in the Del Rio vicinity should be preserved in areas where incompatibility impacts between agriculture and residential uses can be minimized.

### **GOAL 3**

Further development in the Del Rio area should be planned to ensure that adverse impacts on services and utilities, schools, transportation and circulation, agriculture, water, and air quality are appropriately mitigated.

#### **POLICY A**

All future developments in Del Rio shall be Planned Developments and, in Area II, approved only after a specific plan and EIR are prepared for Area II which address cumulative development impacts on the entire Del Rio area, Community Plan conformance, and methods of plan implementation.

### **GOAL 4**

Future development in the Del Rio area should be supportive of a high quality rural/residential/recreational life style.

### **GOAL 5**

Future development shall be served by adequate public infrastructure.

#### **POLICY A**

All future development in Del Rio shall require underground utilities and facilities for community-wide secondary sewage treatment and water supply systems.

**GOAL 6**

Significant natural resources in the community shall be preserved.

**GOAL 7**

The Del Rio community shall not be allowed to become an example of inadequately planned leap-frog urban development on prime agricultural land which outpaces demand and overrides community sentiment.

### **III. LAND USE PLAN**

#### **LAND USE – RESIDENTIAL**

Land use in Area I of the Del Rio Community Plan area includes residential units developed as both attached and detached family homes, agricultural use largely located in the southern portion of the Del Rio area, and open space and recreational use. As of June of 1992, there are only two substantially sized locations which are not already developed or approved for development in Area I. Area II, however, the southerly portion of Del Rio, presently remains in productive agricultural uses.

#### **STANDARDS FOR FUTURE RESIDENTIAL DEVELOPMENT**

The Del Rio Community Plan establishes the following standards for future residential development in Del Rio Area II:

1. All future residential developments within Area I and Area II of Del Rio shall be Planned Developments (PDs). Planned Developments in Area II shall be consistent with a Specific Plan for Area II which addresses the cumulative impacts of this additional development on the entire Del Rio area.
2. Planned developments adjacent to agricultural land shall be required to incorporate buffers, such as roads, green belts, or natural open spaces, between residential and ag use so as to minimize potential use incompatibilities.
3. Planned Developments shall incorporate minimum standards for set-backs and streetscapes approved by the Planning Commission following consultation with the Del Rio Property Owners Association.
4. Future Planned Developments within Del Rio shall not be gated for the purpose of restricting access to the public.
5. Future Planned Developments within Del Rio shall dedicate, in land or funding, the equivalent of at least 15 percent of the project site to natural or landscaped open space with public access. This standard shall not restrict the developer from dedicating additional space for the exclusive use of property owners within the Planned Development. The Specific Plan shall address this issue in detail and include recommendations for implementation.

#### **RESIDENTIAL DENSITIES**

Residential densities for Del Rio shall be shown on the Del Rio Community Plan map. For Area I, the densities shown shall be used in conjunction with the Low Density Residential General Plan designation. For Area II, the densities shown shall serve as the basis for Specific Plan analysis including designing of water and sewage systems, road, and other service needs. The documents shall also provide the baseline for CEQA analysis.

The exact boundaries of these densities as they are eventually implemented shall be determined by the Specific Plan.

## **TIMING OF RESIDENTIAL DEVELOPMENT**

Residential development in Del Rio has generally kept pace with demand, with residents of the community seemingly supportive of this approach. In order to ensure that residential development does not outstrip demand, that there is adequate time to assess the impact of each subsequent development on the environment, and that the utilities used in the area are effective; this Plan includes the following provisions:

The Board of Supervisors will approve the proposed Planned Development in Area II of Del Rio only if the Planned Development conforms to the Specific Plan. The Specific Plan shall include a phasing program to ensure that proper infrastructure and services are available, as well as to provide for a growth rate consistent with maintenance of the character of the Del Rio area.

## **GOLF COURSE EXPANSION**

This plan anticipates that the Del Rio Golf Course expansion will take place at some time in the next few years, and in fact, this plan would allow the expansion to occur at any time, or not at all, at the discretion of the Del Rio County Club and the County. Any such expansion into the easements held by the U.S. Army Corps of Engineers must be approved by that agency and other appropriate Federal agencies. However, the existence of the Del Rio Golf and Country Club in the area was and remains the major justification for the use of adjacent prime agricultural land in the area for residential development. Considering the current waiting list for membership in the club; unless the golf course is expanded and the membership enlarged, some of the justification for further residential development in the Del Rio area will be missing. The Specific Plan process EIR shall therefore, acknowledge and discuss the membership status of the Country Club as of the time the plan is actually prepared.

## **AREA I**

Any Planned Development on the northwesterly portion shall incorporate further improvements to Carver Road, to the intersection of Carver Road and Ladd Road if indicated by the project EIR, and also to the intersection of St. John Road and Ladd Road. This Planned Development may also incorporate walking or biking trails, open to the public, adjacent to the areas designated in this Plan as Natural Open Space along the river if this is found to be environmentally acceptable, subject to the review and approval of appropriate Federal and State agencies.

Any Planned Development on the easterly portion will incorporate further improvements to McHenry Avenue and of the intersection of St. John Road and Ladd Road. This Planned Development will also incorporate a walking or biking trail, open to the public, adjacent to the areas designated in this Plan as Natural Open Space along the river, again only if this is found to be environmentally acceptable by all appropriate agencies.

# Existing Land Use

- golf course
- open space
- river
- ag use

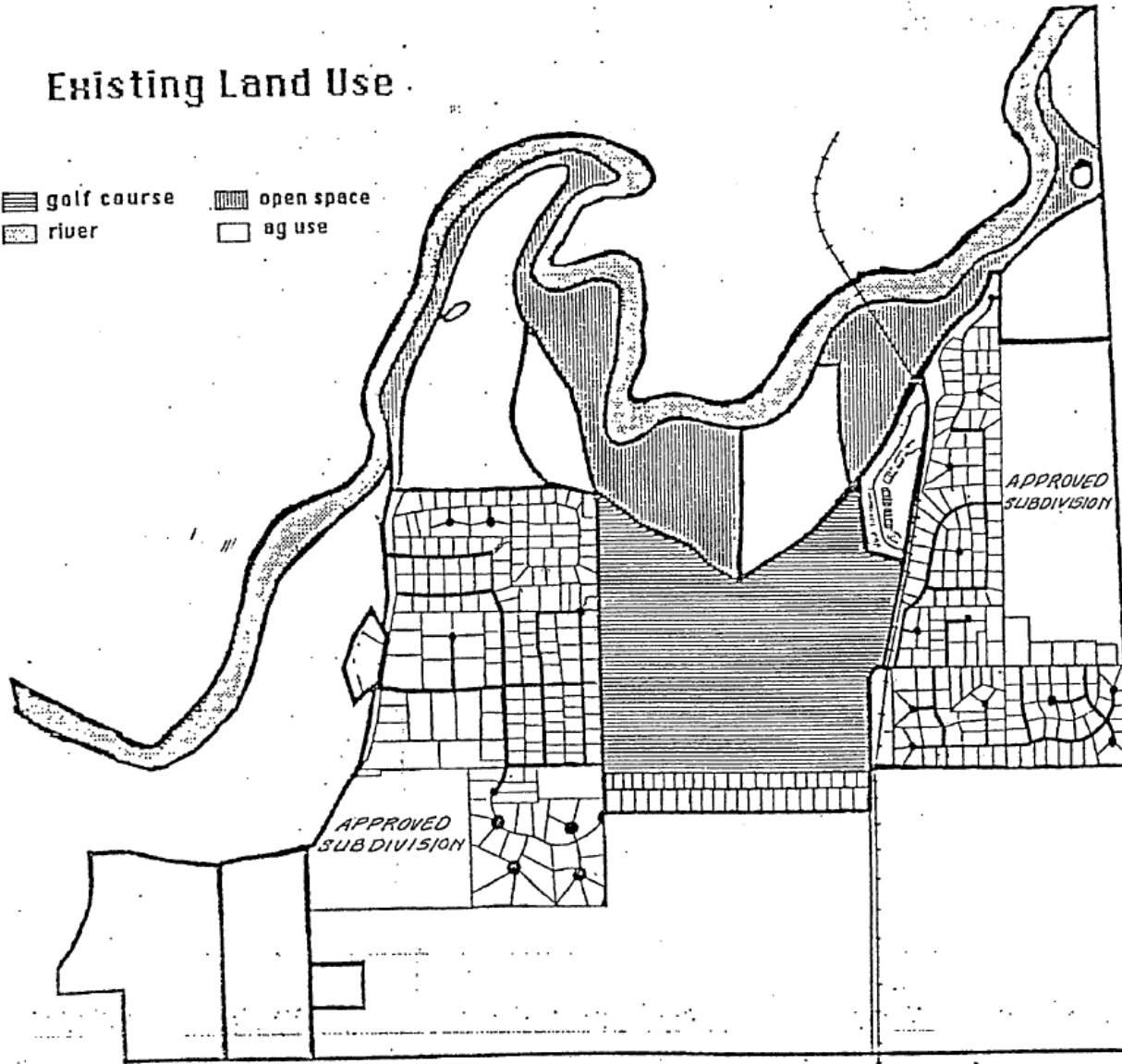

***THIS PAGE INTENTIONALLY LEFT BLANK***

## **AGRICULTURAL USE**

With the ultimate development of both Area I and Area II, agricultural uses within the area covered by the Community Plan will be eliminated. The Area II Specific Plan must address this conversion by phasing developments and requiring the location of development to be such that it avoids premature cessation of or impacts to remaining farmland. The goal is to keep farmland within Del Rio in production as long as possible, while at the same time allowing orderly growth consistent with the Community Plan and the Specific Plan.

The continued agricultural use of land surrounding Del Rio will help to sustain the existing rural atmosphere of the area, promote ground water recharge and preserve this prime agricultural land for further generations. However, it will also result in unavoidable impacts related to the potential incompatible residential and other uses within the Community Plan area. In order to minimize these impacts as much as possible, the Specific Plan shall make provisions for buffers between new development and remaining agricultural area, with the buffers being located within the boundaries of the development as opposed to being on the farmland.

***THIS PAGE INTENTIONALLY LEFT BLANK***



## **OPEN SPACE/RECREATION/OTHER**

### **NATURAL OPEN SPACE**

Within the Del Rio community there exists approximately 75 acres of land comprised mostly of riparian vegetation. This area is located adjacent to the Stanislaus River and runs along the northern community plan boundaries. Riparian woodland habitat and its associated vegetation and animal species are considered biologically significant. This plan designates these areas as Natural Open Space, and in addition, a significant portion of the golf course extension will remain as natural open space. This designation would preclude future residential development from occurring along, and provide for scenic transition to, the permitted uses within this area. The Natural Open Space designation shall, at a minimum, correspond to the 8,000 cubic feet per second easements for flowage and vegetation held by the U.S. Army Corps of Engineers, shown on the Flowage & Fish & Wildlife Easement map and no uses will be permitted therein unless specifically approved by the Corps and other appropriate agencies consistent with all applicable regulations.

### **RECREATION**

Del Rio Golf Course and Country Club (private) currently encompasses approximately 130 acres in the center of the Community Plan area. The 18-hole golf course is proposed to be expanded, by adding approximately 30 acres for a future total of 160 acres and 27 holes. This golf course is private, open to members only, and includes several tennis courts on-site. On the north side of the Stanislaus River access from the Del Rio community there is a large state park adjacent to the river which is accessible to the residents of Del Rio via River Road off McHenry Avenue. Swimming and picnic table are available.

Most of the homes in Del Rio area are built on large lots, and many have private pools or other recreational amenities (such as tennis courts or spas) on-site. Many of the residents of the Del Rio area belong to the Del Rio County Club. Considering the Insert Flowage & Fish and Wildlife Easement recreational opportunities available to most of the residents of Del Rio; the need for a public park incorporating additional recreational amenities such as tennis courts, or swimming pools or existing future residents is not altogether clear. Some residents have expressed concern that a public park in Del Rio may not be adequately patrolled during evening hours. The Specific Plan prepared for Area II shall include provisions for establishing and maintaining a neighborhood park consistent with County General Plan standards.

### **LANDSCAPING**

Although there are some sentiment for the development of thematic landscaped parkways treatments and gated entry into and within the Del Rio community to provide a sense of community and security; there is no strong consensus to support or finance this approach among Del Rio residents, especially since the Del Rio community currently enjoys one of the lowest crime rates in the County, and many residents have chosen to live in the Del Rio area because of its rural atmosphere and the lack of thematic constraints on residence construction or landscape appearance. There is no clear mandate or strict necessity to reinforce the boundaries of the community. However, minimum standards for streetscapes and setbacks may be recommended by the Del Rio Property Owners Association to the Planning Commission as part of the Specific Plan process and in the review of subsequent development projects.

***THIS PAGE INTENTIONALLY LEFT BLANK***

# FLOWAGE & FISH & WILDLIFE EASEMENT

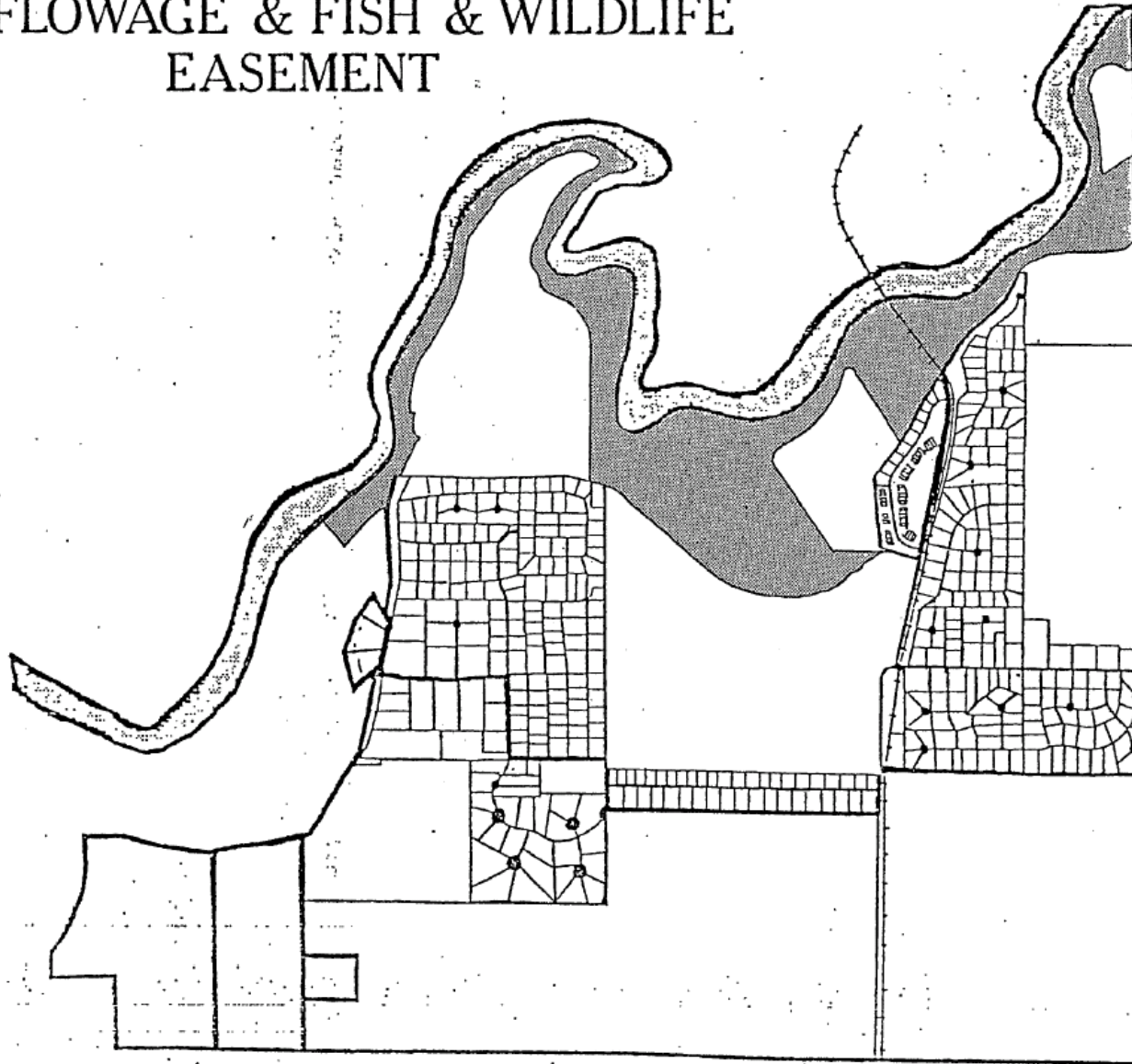

***THIS PAGE INTENTIONALLY LEFT BLANK***

## **COMMERCIAL/SCHOOL**

### **COMMERCIAL**

No commercial uses currently exist within the community plan boundaries. As future development occurs (and due to the isolated location of the community) neighborhood commercial uses were proposed in the STA Plan. This area (20acres) was located at the southeast corner of the community, adjacent to McHenry Avenue and Ladd Road.

Uses would be in accordance with those uses allowed under the County's Neighborhood Commercial zone, and could include: financial institutions, backer shops, service stations, and retail stores. The Specific Plan for Area II shall include a listing of the uses which would be allowed.

As with the proposed neighborhood park, the neighborhood commercial site would be intended as a convenience to serve community residents. The Specific Plan for Area II shall address the placing of a neighborhood commercial designation within the Plan boundaries at the corner of Ladd Road and McHenry Avenue.

### **SCHOOL**

Students from the Del Rio area attend school either at Stanislaus School located on Kiernan, Prescott Junior High located on Rumble Road in Modesto, or Davis High School located in Modesto. Stanislaus and Prescott Junior High are part of the Stanislaus Union School and Davis High is part of the Modesto High School District. Bus service is available to all students in the area on a daily basis.

No school sites currently exist on-site in the Del Rio area. As buildout of the community occurs, the influx of additional residents may warrant the need for an elementary or junior high level school. Enrollment levels for these two schools currently serving the area are at or near capacity.

At this point in time, the Stanislaus Union School District is uncertain as to exactly where or when district growth, including that occurring at Del Rio, will necessitate a new school site. This decision is one that will have to be made by the district itself at the appropriate time.

As required by the Land Use Element of the County General Plan, no changes can occur at Del Rio until such time as impacts on schools have been adequately mitigated. The following language suggested by the Stanislaus School District shall be applicable unless superseded by the language in the Specific Plan.

Any and all residential development shall pay impact mitigation fees to both school districts in a sum per dwelling unit to be determined at the time the Specific Plan for Area II is adopted. Issuance of a building permit for any residential development shall be dependent upon payment of such fees. The impact mitigation fees shall be adjusted by the districts on January 1 of each

year following plan adoption to reflect any increase or decrease in the All Urban Consumers San Francisco/Oakland All Items Consumer Price Index.

## IV. CIRCULATION PLAN

The basic circulation system for the Del Rio area is already largely in existence being comprised of both major and collector streets. Recent project approvals have included conditions implementing needed system improvements. The Specific Plan of Area II shall identify needs within this area and establish a method of ensuring implementation. Following is a brief summary of the major components of the existing Del Rio area road systems.

### **FREEWAY ACCESS**

Due to the location of the community, freeway access is limited. Freeway access is from Highway 99, located approximately six miles to the west. From Highway 99, Del Rio residents must travel east on Highway 219 (Kiernan Avenue) until reaching Carver, Tully, St. John Roads or McHenry Avenue.

### **MAJOR STREETS**

**McHenry Avenue** – the eastern boundary of the Community Plan will be McHenry Avenue. The plan envisions the ultimate development of McHenry Avenue as a major north/south circulation arterial. Ultimately, this road will be widened to four lanes, (100 foot right-of-way) as indicated in the County's Circulation Element. It will include two lanes in each direction, with traffic signals at the intersections of McHenry with Ladd and (if needed) Stewart Road.

### **COLLECTOR STREETS**

**Ladd Road** – The southern boundary of the Community Plan will be Ladd Road. This road will remain a two-lane east/west roadway, but ultimately may include realignment of the Carver-Ladd intersection, left-turn lanes on both eastbound and westbound approached of Ladd Road and the eastbound approach to St. John Road.

**Carver Road** – Carver Road runs along a portion of the western plan boundary. This road will remain a two-lane north/south roadway, but ultimately will be widened (in portions) to a 60 foot R.O.W., and the curve north of Ladd straightened. Carver Road will provide access to the western portions of the community.

**Tully Road** – Tully Road currently terminates at Ladd Road. This will not change in the proposed plan, although it may extend northbound into Area II, depending upon the results of the Specific Plan process.

**St. John Road** – St. John Road is one of the primary entrances to the community. Ultimately, a left-turn on the eastbound approach of Ladd Road at the St. John intersection may be provided.

# CIRCULATION PLAN

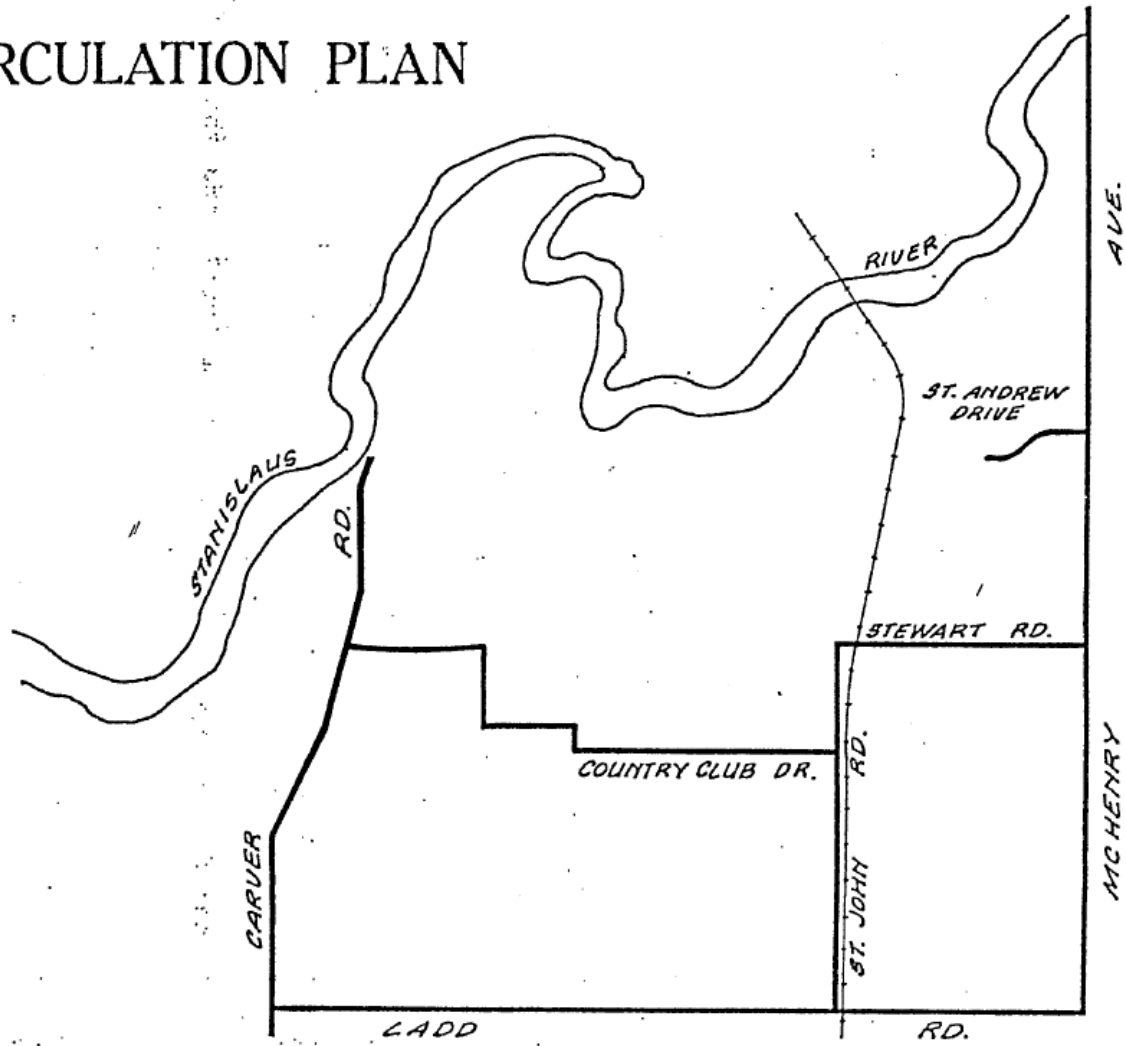

***THIS PAGE INTENTIONALLY LEFT BLANK***



**Stewart Road** – Stewart Road currently provides the only access into the community off of McHenry Avenue. An intersection improvement project is currently planned by the County on McHenry Avenue at Stewart Road.

**St. Andrew Drive** – St. Andrew Drive is located within the Del Rio Ranch Subdivision north of Stewart Road. It is proposed as a new entrance to the community from McHenry Avenue. This entrance will provide a second access to new and established residences west of McHenry Avenue to supplement the existing access through Stewart Road.

The Specific Plan for Area II shall include a more detailed analysis of long-term circulation needs and means of implementing those needs.

## **V. INFRASTRUCTURE SYSTEM**

### **DRAINAGE/FLOOD CONTROL**

There are currently drainage systems for most existing residential developments. The area has curbs and gutters with drainage into dry wells in various locations within the DRCP area.

Flooding on the Stanislaus River is controlled by the New Melones Lake Dam upstream from the Del Rio area.

It is desired that all future development within the DRCP area include curb and gutters that connect to adequate development wide drainage systems. The Specific Plan for Area II shall include a discussion of and recommendation for a positive storm drainage system for the entirety of Area II.

### **WATER**

Homes along Del Rio, Oakmont, and Hillcrest Drives are served with public water from the City of Modesto. All other homes in the area have private individual wells. The Del Rio East development has a private system providing water only to those units.

All subsequent development in both Area I and Area II of the DRCP will be provided with water by the City of Modesto or a successor through development-wide systems which could at some later date be readily connected to an area-wide joint water district. Monitoring and servicing of these water facilities will be conducted by the City of Modesto. In Area I, the developer shall obtain the approval of the Department of Environmental Resources for the proposed water system; and demonstrate that the water system for the development will not have an adverse impact on water quality and quantity produced by existing wells in the community.

For Area II, provisions shall be made for a water supply system to service all developments in Area II. The Specific Plan and supporting environmental documentation shall include a complete water supply analysis to identify for mitigation any significant adverse water related impacts that result from the development of Area II. If the environmental impact report reproduced for the Specific Plan for Area II indicates that a joint water district for the entire Del Rio area would be required to mitigate the cumulative impacts of development in Area II on

water quality and quantity of existing wells, the Specific Plan must address the implementation of such a joint water district for all of Del Rio. It shall also include provisions to set up and maintain the community-wide system. It shall also reflect the needs of the City of Modesto, the water supplier.

## **SEWER**

Sewage disposal in the Del Rio area is generally by septic system. The Del Rio East development has a package treatment system as will Area I projects approved in recent years. While such systems, consistent with Measure X standards can provide adequate wastewater treatment, if development of Del Rio is to continue, it is imperative that a community-wide sewer system be developed.

No future developments within the DRCP area shall use septic systems for treatment of sewage. For Area I, package treatment system(s) shall be constructed for future developments and maintained at all times in accordance with County Department of Environmental Resources approved policies and procedures. They shall be designed to allow conversion to a community-wide system. Prior to development in Area II, a complete analysis of the cumulative impacts of development in Area II on ground water quality and other sewage treatment related issues in Del Rio must be done. The Specific Plan shall also investigate options for including existing non-sewered areas of Del Rio into the system. No development of Area II shall be permitted until provisions have been put in place for such an area-wide system to be implemented.

## **UTILITIES**

The area is served by Pacific Gas and Electric Company (PG&E) for gas, Modesto Irrigation District (MID) for electricity, and Pacific Bell for telephone services. The Specific Plan shall reflect the needs of these providers in ensuring continued adequate service levels.

All further development in the DRCP area shall incorporate below ground utilities exclusively.

## **SERVICES**

Law enforcement on the Del Rio area is provided by the Stanislaus County Sheriff's Office. Fire protection comes from the Salida Fire Protection District. The Specific Plan shall reflect the needs of these service providers in ensuring continued adequate service levels.

# **VI. IMPLEMENTATION PROGRAMS**

## **GENERAL PLAN**

By its adoption by the Board of Supervisors, this Community Plan is incorporated into the Stanislaus County General Plan. The Community Plan shall serve to formally delineate and define "Del Rio" for planning purposes. The Tier I EIR prepared for the Community Plan has resulted in the creation of the Community Plan with two distinct areas.

Area I shall be shown on the Del Rio Community Plan map. All areas shown for residential uses shall be designated Low Density Residential and shall be developed consistent with the

density designations of the Community Plan. The Planned Development zoning designation shall be used for all rezoning proposals.

- All projects shall be required to mitigate air quality impacts by complying with any County or regional indirect Source Rule in effect at the time the final map is recorded.
- Full water quality studies, to the satisfaction of the Department of Environmental Resources must be completed prior to approval of any rezoning. The studies shall include, at a minimum, the following information:

### **Hydrology**

A detailed site specific hydrologic study should be conducted to determine effects of construction and build-out on surface runoff and permeability. This should include the evaluation of location and design of storm water runoff catch basins that could also function as groundwater recharge basins.

A detailed hydrologic study shall be conducted to quantify the migration of groundwater into the area. One possible mitigation measure that should be investigated in the feasibility of developing artificial groundwater recharge basins that could function as both scenic/recreational areas and groundwater recharge areas.

### **Geology**

A site specific soil analysis should be submitted from desired locations for the treatment water discharge. Soil samples should be tested for nitrate, DBCP, and general mineral to evaluate the quality of soil the recharge water would percolate through.

By selecting appropriate locations for sanitary sewer treated water discharge areas, the flushing out of nitrate or DBCP from higher concentration areas in the soil into groundwater can be avoided.

### **WATER QUALITY**

A detailed investigation of the local groundwater gradients to enable a precise determination of the transportation/mixing effect of the shallow groundwater should be accomplished. This should be combined with the assessment of nitrate loading to show that nitrate input will not cause undue degradation of groundwater.

***THIS PAGE INTENTIONALLY LEFT BLANK***

# Appendix I-A3

## DENAIR COMMUNITY PLAN

Adopted by the Stanislaus County Board of Supervisors  
DECEMBER 15, 1998\*







*\*A technical update removing reference to the former Stanislaus County Redevelopment Agency and corrections for a typo were adopted on August 23, 2016, as part of the 2015 General Plan Update. Updates to the Community Plan map to reflect previously approved amendments to the Community Plan and removal of circulation to reflect updates to the Circulation Element were also adopted on August 23, 2016 as part of the 2015 General Plan Update.*

***THIS PAGE INTENTIONALLY LEFT BLANK***





# Denair

## COMMUNITY PLAN

### Land Use Designations:

-  Commercial
-  Industrial
-  Residential - Estate
-  Residential - Low
-  Residential - Medium
-  Residential - Medium-High

### Parks and Schools:

-  Existing Park
-  Proposed Park
-  Existing School
-  Proposed School

### Rellevant Boundaries:

-  Community Plan Boundary

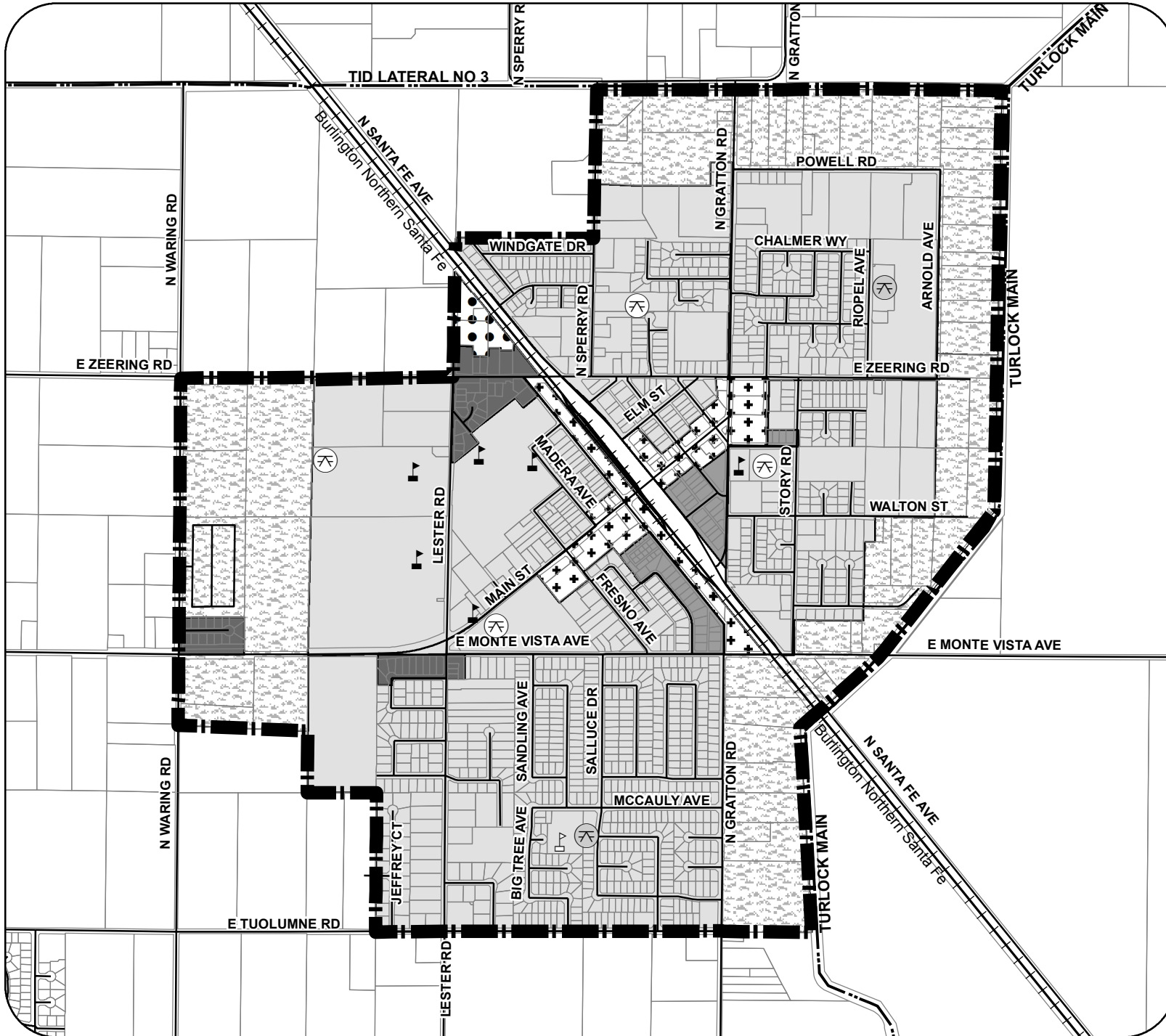
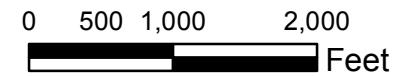

***THIS PAGE INTENTIONALLY LEFT BLANK***



## **DENAIR COMMUNITY PLAN**

**Land Use.** One of the primary land use changes involves establishing an urban buffer area around the community. To achieve an urban buffer, parcels located on the periphery of the Plan area have been designated as Estate Residential (ER). The Estate Residential land use designation will allow for the gradual blending of urban development with surrounding agricultural uses. Estate Residential also promotes a well-defined rural small town characteristic edge between the City of Turlock and the community of Denair where agricultural operations may no longer continue as a viable land use option.

The future growth forecasted for Denair translates into demand for a variety of housing types. Vacant and underutilized parcels within the existing Denair Community Plan area offer the potential for meeting the forecasted population growth housing needs. Suitable locations for Medium Density Residential (MDR) and Medium-High Density Residential (MHDR) housing is within the interior of communities, providing residents convenient access to public services, retail shopping and public transit opportunities. Development of housing at medium and medium-high densities in and around the community's Commercial district would positively influence the overall appearance of the community and add new residents who are likely to shop in Denair's commercial district. As such, Medium and Medium-High Density land use designations have been moved from Denair's periphery to its interior.

With the community's small size and the proximity to competing commercial centers outside the community (City of Turlock), the community's downtown commercial core takes on a neighborhood convenience and specialty commercial focus that meets the convenience goods and services needs of local residents. In addition, the downtown commercial area can become a gathering place for local community events. To provide an opportunity for the revitalization of Denair's historical urban core, the community's commercial area has been centralized and compacted.

**Circulation.** Waring Road, Taylor Road (west of Waring Road) and Zeering Road (west of Waring Road) are classified as Major Roads. Class II bike lanes are designated along major roadways consistent with the Stanislaus Area Association of Governments' *Regional Bicycle Transportation Master Plan*. Additional Class II bike lanes provide connectivity to downtown, school and recreational facilities and to the multi-purpose trail system.

A multi-purpose trail, offering access to a variety of users, including pedestrians, cyclist, and equestrians is planned along the canals on the plans eastern and northern edges. The multi-purpose trail ties into the community's bikeway network.

**Public Facilities.** The community of Denair is devoid of parks and other public outdoor areas for recreating, gathering, and socializing. The County's minimum standard for providing adequate parkland is 3 acres of parkland / 1,000 residents. The Community Plan diagram depicts the general location of future neighborhood and community park sites. The general locations of future park sites are conceptual and indicative of park locations based on service area radius, major streets, and surrounding land uses. Parks should be located in the general vicinity shown in the Community Plan.

The following general standards define the various park designations identified in the Denair Community Plan:

**Neighborhood Park - 3 to 5 acres.** Neighborhood parks are designed to meet local neighborhood needs, and are intended to be within walking or bicycling distance of one-half mile from neighborhood residences. A neighborhood park service area should avoid crossing any major natural or manmade barriers (e.g., railroads, canals, and major roads) that inhibit

access to the park. Neighborhood parks usually emphasize child oriented facilities providing a variety of play spaces and associated amenities.

**Community Park - 10 to 15 acres.** A community park should serve the community and be developed to serve specific recreational needs such as baseball, softball, hard court areas, swimming pool, or recreation center. Patrons of these facilities are expected to drive to the park. As such, community parks should provide adequate parking areas and access from collector and/or major roads. The location of the community park should avoid the need to travel through neighborhoods. Care must be taken when siting a community park to avoid conflicting with nearby residential uses. Community parks can be developed as joint-use facilities able to accommodate seasonal storm drainage basins.

**Setting.** The community of Denair is located in the south central portion of Stanislaus County, east of the City of Turlock. Most of the community is surrounded by productive farmland, though residential development within the City of Turlock lies only a mile to the west. The community is bisected by the Burlington Northern-Santa Fe Railroad.

**Development History and Pattern.** Originally a Quaker settlement, the Denair community was first called Elmwood Colony and then Elmdale. In the early 1900s, the Modesto Bank subdivided 640 acres as a townsite. John Denair, a railroad superintendent, subsequently purchased the townsite, and the town's name was changed, fittingly, to Denair.

The original townsite was surveyed and developed at right angles to the Burlington Northern-Santa Fe Railroad, which runs in a northwest/southeast direction. More recent development patterns have been on the traditional north/south grid, leaving Denair's historic core physically offset from newer development.

**Land Use.** The Denair Community Plan area encompasses 1,013 acres between Taylor Road on the north and Tuolumne Road on the south. The Turlock Irrigation District Main Canal binds Denair on the east while Waring Road generally forms the community's western boundary. The Denair community is buffered by land designated as Estate Residential. This residential land use designation provides a transition from the urbanized environment of the town to surrounding agricultural uses. In the southwest portion of the plan, an agricultural buffer is established between the Denair community and the City of Turlock.

Denair's commercial core area is compact to maximize development opportunities. Higher density residential development is located near the downtown commercial core for easy access to downtown services. The Denair Community Plan contains adequate land to support a population of approximately 8,000 residents. Table 1 provides a summary of land uses within the Denair Community Plan area.

**Table 1: Denair Community Land Use Profile**

Land Use	Developed Acreage	Vacant Land	Total Acreage	Percent of Total
Estate Residential (ER)	132	153	285	28%
Low-Density Residential (LDR)	275	263	538	53%
Medium Density Residential (MDR)	17	0	17	2%
Medium-High Density Residential (MHDR)	6	11	17	2%
Commercial (C)	12	24	36	4%
Industrial (I)	5	0	5	1%
Parks*	0	34	34	3%
Schools**	61	20	81	8%
<b>Total</b>	<b>508</b>	<b>505</b>	<b>1,013</b>	<b>100%</b>

**Notes:**

*\*Parks vacant land acreage is based upon a calculation need of 3 acres / 1,000 population projected in the Community Plan*

*\*\* School vacant land acreage assumes two additional elementary schools will need to be provided.*

**Circulation.** Primary roadways within the community are Monte Vista Avenue, Main Street, Zeering Road, Lester Road, and Santa Fe Avenue. Traffic within the community is relatively light, with most of Denair’s roadways operating at LOS C or better. Signalization of the community’s main intersections (Lester Road at Monte Vista Ave/Main Street, Santa Fe Avenue at Main Street and Zeering Road at Gratton Road) will improve traffic flow. Non-motorized transportation is encouraged via a system of recreational trails and bicycle lanes that connect the community’s residential areas with downtown, recreational and school facilities and along the irrigation canals at the community’s edge.

**Public Services**

**Wastewater Collection and Treatment.** The Denair Community Services District provides wastewater service. Wastewater is conveyed to the City of Turlock Wastewater Treatment Plant for treatment. For the past 13 years, growth in Denair has been restricted due to the capacity of the sewer interceptor between Denair and Turlock Wastewater collection system improvements are underway to improve delivery of wastewater to the City of Turlock Wastewater Treatment Plant.

**Water Service.** The Denair Community Services District provides potable water service to the Denair community. Domestic water is supplied by wells that pump groundwater. Water quality is good and no treatment is provided

**Law Enforcement.** Law enforcement is provided by the Stanislaus County Sheriff’s Department that maintains a sheriff’s substation within the Denair community. The California Highway Patrol shares space with the County Sheriff’s Department in the substation located on East Main Street.

**Fire Protection.** The Denair Fire District (DFD) has the responsibility for fire protection, paramedic services and emergency rescue services to Denair and surrounding areas. The DFD is a volunteer fire department. Response time within the Denair community is 3 to 5 minutes.

**Schools.** Denair is located within the Denair Unified School District. The District has one elementary school (K-4), one middle school (5-8), and one high school (9-12). To accommodate growth, the Community Plan identifies general locations for future school sites.

**Parks and Recreation.** The Denair Community Services District provides park and cultural activity centers services in the community. The community's current parkland inventory does not meet the County standard of 3 acres of parkland per 1,000 residents. The Community Plan illustrates the general location of future park sites, including 1 community Park and 3 neighborhood parks.

## Goals, Policies and Implementation Measures

The following goals, policies and implementation measures are directed specifically toward the Denair community and are intended to guide development within the Denair Community Plan area:

### GOAL ONE

Reinforce Denair's small rural town character.

#### POLICY ONE

The County shall work with the Denair Municipal Advisory Committee, and other interested groups, to develop a Downtown Master Plan for the planning and implementation of programs to support the vitality of the downtown area. The Master Plan should include detailed development guidelines for downtown.

#### POLICY TWO

Promote the vitality of Denair's central business district and preserve Denair's small town character by encouraging it to become a unique shopping district and community events area with a variety of retail commercial, office residential, civic, cultural and recreational uses.

#### POLICY THREE

Reduce the area currently designated for commercial uses in the community as a means of concentrating retail activity in a focused area.

#### IMPLEMENTATION MEASURES

1. Develop gateway treatments to mark the entries to the downtown at Santa Fe Avenue and Main Street and at Gratton Road and Main Street.
2. Create a pleasant pedestrian street environment through attractive streetscape design and features including street trees, lighting, sidewalks and planters.
3. Develop design guidelines for new and existing building renovation in the downtown, in keeping with a small town, pedestrian oriented street character.

***THIS PAGE INTENTIONALLY LEFT BLANK***

## **GOAL TWO**

Provide a well-defined community edge between Denair and adjacent agricultural land, as well as between Denair and the City of Turlock.

### **POLICY ONE**

Create a greenbelt / buffer around the perimeter of the community that provides clear sense of identity for the community of Denair.

### **POLICY TWO**

The Denair Community Plan should promote very low-density residential uses along the community's edge or periphery in order to reduce conflicts with surrounding agricultural uses, as well as to establish and define a permanent buffer between the community of Denair and the City of Turlock.

### **IMPLEMENTATION MEASURES**

1. Estate Residential shall be designated along the northerly, westerly and easterly periphery of the Denair Community Plan area to reduce urban density toward the edge of the Community Plan area.
2. The sizing of sewer and water lines should be reduced as they approach the northerly, westerly and easterly periphery of the Denair Community Plan area to limit growth influences beyond the Plan area.
3. Landscape design requirements shall be considered for new projects, which develop along the entryways to the community of Denair, in particular to Waring Avenue, Monte Vista Avenue, Gratton Road and Santa Fe Avenue. Landscape design should promote a sense of transition from the surrounding agricultural area to urban setting. Utilization of trees to screen urban uses along these entryways is encouraged.
4. Within the Community Plan area, properties designated Low-Density Residential and located outside the boundaries of the Denair CSD, may be designated, "Low-Density Residential" or "Estate Residential" on the General Plan. (This will allow development of ½ acre lots with public water or 1 acre lots without public water or public sewer.)

***THIS PAGE INTENTIONALLY LEFT BLANK***



### **GOAL THREE**

Provide for the non-motorized transportation needs of the Denair community.

#### **POLICY ONE**

Provide safe and convenient pedestrian and bicycle facilities to various destinations throughout the community of Denair.

#### **POLICY TWO**

Provide pedestrian and bicycle facilities that link community residents to schools, parks, civic facilities and the community's downtown core in accordance with the Denair Community Plan diagram.

#### **POLICY THREE**

The community pedestrian and bicycle facilities shall connect to regional pedestrian and bicycle facilities.

#### **IMPLEMENTATION MEASURES**

1. Develop irrigation canals as non-motorized transportation enhancement to promote the walking, cycling and other non-motorized means of transportation.
2. The County shall explore a cooperative agreement with the Turlock Irrigation District to use canal right-of-way / easement for multi-purpose recreational trails, as identified on the Denair Community Plan diagram.
3. Bicycle facilities shall be included as part of road improvement projects where said roadways are identified as bike lanes on the Denair Community Plan.

***THIS PAGE INTENTIONALLY LEFT BLANK***

## **GOAL FOUR**

Provide for the recreational needs of residents of the Denair community.

### **POLICY ONE**

New development shall provide the residents of Denair with adequate parkland facilities to meet the County standard of 3 acres per 1,000 residents.

### **IMPLEMENTATION MEASURES**

1. The County shall work to acquire and develop parkland, including adequate facilities to accommodate one community park. The general location of future park sites is portrayed on the Community Plan diagram.

***THIS PAGE INTENTIONALLY LEFT BLANK***

# Appendix I-A4

## HICKMAN COMMUNITY PLAN

Adopted by the Stanislaus County Board of Supervisors

DECEMBER 19, 1995\*

*\*A technical update to service providers, and conditions in and surrounding the community were adopted on August 23, 2016, as part of the 2015 General Plan Update. The 2015 update also incorporated into the Community Plan information from the June 23, 1987, adopted Support Documentation to the Stanislaus County General Plan.*

***THIS PAGE INTENTIONALLY LEFT BLANK***

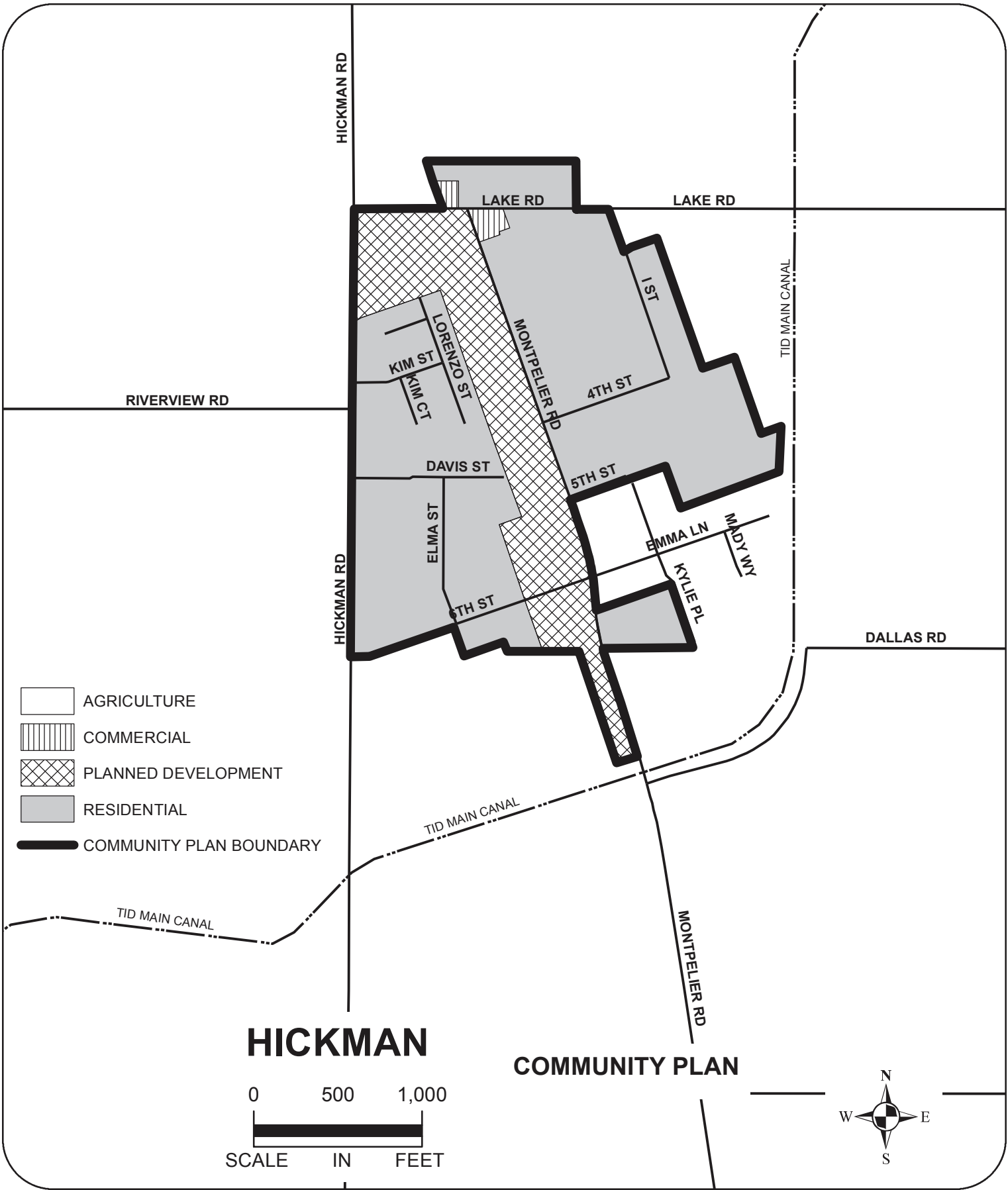

***THIS PAGE INTENTIONALLY LEFT BLANK***



## **HICKMAN COMMUNITY PLAN**

### **Description of Hickman**

The community of Hickman is located three miles south of the City of Waterford on the east side of Hickman Road.

### **History**

The community was built in 1891 as a shipping center for grain upon the extension of the Southern Pacific Railroad from Oakdale to Merced.

### **Land Use**

Hickman consists primarily of single-family homes and commercial uses which service its residents. Hickman also includes an industrial operation which manufactures and repairs mining, construction, and agricultural equipment. The agricultural land surrounding Hickman is used for orchard, dairy, and grain farming.

### **Available Urban Services**

Domestic water is supplied by the City of Waterford, police protection from the Stanislaus County Sheriff's Department and fire protection from the Stanislaus Consolidated Fire District.

### **Transportation**

Hickman Road is the major link for travel to Waterford, Hughson and Turlock/Denair.

### **Development Potential**

Significant population growth is not anticipated in Hickman. Presently, the service area is mostly developed and there has been little demand for expansion. Some growth is expected in existing lots, but there are a limited number of vacant lots that front on County roads.

***THIS PAGE INTENTIONALLY LEFT BLANK***

# Appendix I-E

## KEYES COMMUNITY PLAN









Adopted by the Stanislaus County Board of Supervisors  
APRIL 18, 2000

*\*Updates to the Community Plan map to reflect previously approved amendments to the Community Plan and removal of circulation to reflect updates to the Circulation Element were adopted on August 23, 2016, as part of the 2015 General Plan Update.*





***THIS PAGE INTENTIONALLY LEFT BLANK***

# Keys COMMUNITY PLAN

## Land Use Designations:

-  Commercial
-  Commercial - Highway
-  Industrial
-  Planned Industrial
-  Residential - Low
-  Residential - Medium
-  Residential - Medium-High
-  Urban Transition

## Parks and Schools:

-  Existing Park
-  Proposed Park
-  Existing School
-  Proposed School

## Rellevant Boundaries:

-  Community Plan Boundary

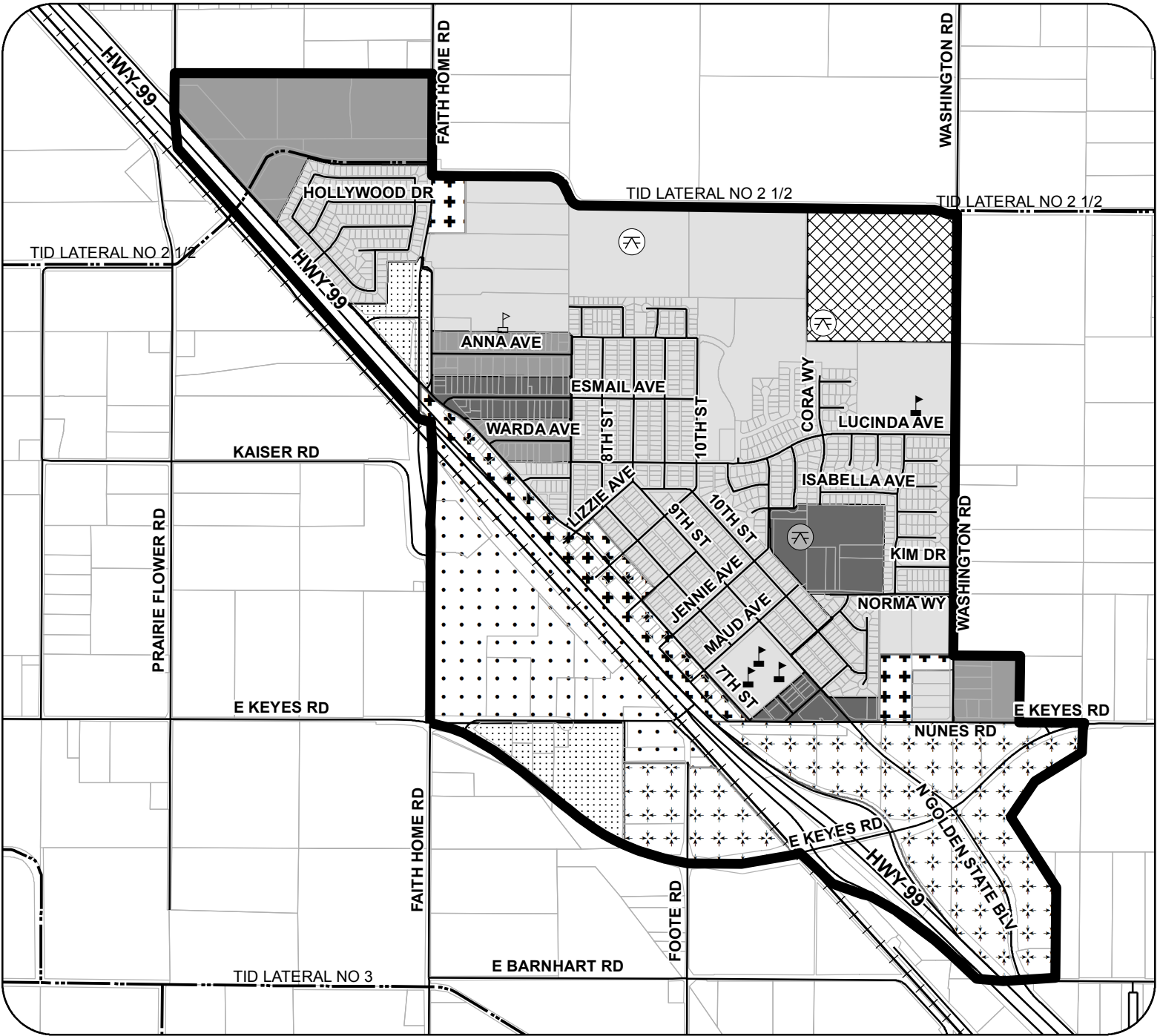
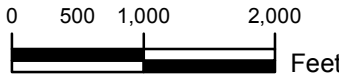

***THIS PAGE INTENTIONALLY LEFT BLANK***

## **KEYES COMMUNITY PLAN**

**Land Use.** Growth forecasted for Keyes translates into a demand for a variety of housing types. Vacant and underutilized parcels within the existing Keyes Community Plan area, along with a northward expansion of the Community Plan area offer the potential for providing the forecasted population growth housing needs. Growth, in the form of residential development, has been directed east of State Route 99 to avoid conflicts with industrial uses west of State Route 99. With the exception of an established mobile home park located north of Turlock Irrigation District's Upper Lateral 2½, Medium-and Medium High-Density land use designations are moved from the periphery of Keyes to the interior of the community. Establishment of medium and medium high-density housing adjacent to the community's commercial districts and public amenities will accommodate long-range housing needs for the community and County, while encouraging a compact community form.

With the community's small size and proximity to competing commercial centers outside the community (cities of Ceres and Turlock), the community's Commercial designations take on a neighborhood convenience focus. The Commercial designations within the community are intended to provide essential community retail goods and services. Activities may range from a single commercial use to a neighborhood shopping center. The Highway Commercial land use designation adjacent to the State Route 99 / Keyes Road Interchange is intended to provide for and promote concentration of commercial uses serving the needs of the traveling public. The State Route 99/Keyes Road Interchange also serves as an important gateway into the community.

Industrial and Planned Industrial land uses west of State Route 99 are buffered from sensitive land uses to the east of the highway. Industrial and Planned Industrial uses are afforded direct access to heavy rail service, and vital regional north-south and east-west transportation corridors.

The Community Plan includes an area designated Urban Transition. The Urban Transition land use designation recognizes the lands current commitment to Williamson Land Conservation Act contracts. The Urban Transition land use designation also recognizes the importance of this area in the overall development of community-wide circulation improvements and relationship to adjacent planned urban land uses. It is anticipated this area will, in the future, be developed as Low Density Residential.

**Community Character.** Community character is crucial for establishing the overall vision of what constitutes a desirable and viable community. The present appearance of the community along the State Route 99 corridor, as with many corridor communities, is unattractive. A lack of urban landscaping, key community entryways and unsightly land uses adjacent State Route 99 contribute to a negative image which discourages interest in investing in the community.

The residents of Keyes envision a cohesive small town that encourages social interaction among its community members. The Plan along with its goals, policies and implementation measures address neighborhood character, community edge and entryways into the community. The community core along 7<sup>th</sup> Street has its own unique character as a pedestrian-oriented concentrated area of residential, commercial, and public and quasi-public uses. Future development should enhance the vitality of the community core along 7<sup>th</sup> Street while retaining a diversity of residential, commercial and public and quasi-public uses.

**Circulation.** Faith Home Road (north of Keyes Road), Keyes Road (east of Faith Home Road) and Golden State Boulevard (south of Keyes Road) are classified as Major Roads. Rohde Road, 7<sup>th</sup> Street, Nunes Road, and Washington Road are classified as Collectors. To promote

a traditional local street pattern that evenly disperses traffic throughout the community; the Plan identifies the alignments for future roadway extensions. The Community Plan includes future easterly roadway extensions of Hollywood Drive, Anna Street, Esmail Avenue, Maud Avenue, and Norma Way to serve east-west circulation. The Community Plan also includes future northerly roadway extensions of Jennie Avenue and Stella Avenue to serve north-south circulation.

To optimize Highway Commercial opportunities and accommodate forecasted traffic volumes on Washington Road, Ninth Street between Nunes and Keyes Roads should be abandoned. In its place, Washington Road should be extended to Keyes Road, opposite Golden State Boulevard. These modifications will improve circulation within the community and create a clear distinction between highway commercial and community related commerce, while establishing an opportunity for a prominent gateway for the community. The broad open area of the highway on- and off-ramps provides an opportunity for establishing a distinctive landscaped entry into the community.

The Community Plan encourages bicycling and walking. Two forms of non-motorized transportation routes are depicted on the Community Plan diagram. Bike lanes are designated along major roadways consistent with the Stanislaus Council of Governments' (formally Stanislaus County Area Association of Governments) *Regional Bicycle Transportation Master Plan*. Bike lanes provide connectivity to neighborhoods, commercial centers, school and recreational facilities.

A multi-purpose trail, offering access to a variety of users including pedestrians, cyclists and equestrians, is planned along Turlock Irrigation District's Upper Lateral No 2½ right-of-way. The multi-purpose trail, which ties into the community's bikeway, provides a completely separated right-of-way with minimum cross flows by motorists.

**Parks.** Hatch Park is the only park available to all residents of Keyes. This park does not meet the County's minimum standard of providing 3 net acres of parkland/1,000 residents needed to support the community's current population. To accommodate growth, the Community Plan diagram envisions the expansion of Hatch Park into a community park. The Community Plan also identifies the general location of future neighborhood park sites. The neighborhood park symbols do not denote precise park locations, but suggest approximate locations for additional parkland acquisitions.

The following general standards define the various park designations identified in the Keyes Community Plan:

**Neighborhood Park – 3 to 5 Acres.** Neighborhood parks are designed to meet local "neighborhood" needs, and are intended to be within walking or bicycle distance of one-half mile from neighborhood residences. A neighborhood park service area should avoid crossing any major barriers (e.g., canals, collectors or major roads) that inhibit access to the park. Neighborhood parks should emphasize child-oriented facilities providing a variety of play spaces and associated amenities. Neighborhood parks should also be bound on all four sides by local streets to promote safety and public access.

**Hatch Community Park – 15+ Acres.** To provide for recreational needs of the community such as baseball, softball, and hard court areas, and family-oriented activities such as picnic areas and an indoor recreation center, Hatch Park should be enlarged to provide a minimum of 15 acres. Patrons are expected to drive to this facility. As such, Hatch Park should be bound by streets to minimize on-site parking requirements. As a highly active center, residential or other noise sensitive land uses should not directly abut the park.



**Schools.** Keyes is served by two school districts providing elementary and secondary education. The Keyes Unified School District provides for elementary (grades K-8) education. The Turlock Joint Union High School District provides for secondary (grades 9-12) education. Existing, planned, and proposed school sites are shown on the Community Plan diagram. The proposed elementary school symbol does not denote the precise school site location, but suggests an approximate location for an additional elementary school.

**Development History and Pattern.** Keyes dates back to 1871 when it was a railroad siding of the Central Pacific (now Union Pacific) Railroad. The siding was named Keyes Switch, after Thomas J. Keyes, a state senator who resided nearby. The community grew slowly, consisting of only 16 families when the Keyes Grammar School was established in 1905-1906. The construction of the school and a church spurred additional growth, which slowed once more during the Great Depression. In the 1990s, the community grew faster than the County on average and reached an estimated 3,400 residents by 1998.

Like many other Central Valley towns, Keyes' original townsite was laid out at right angles to the northwest/southeast trending railroad. More recent development patterns have been on a traditional north/south grid, leaving Keyes' historic core physically offset from newer development. State Route 99 parallels the Union Pacific Railroad corridor to the east. The State Route 99 bypass, constructed in the mid-1980s, physically divides the community.

**Land Use.** The Keyes Community Plan area contains adequate land to support a population of approximately 9,300 residents. The Community Plan accommodates future growth in the most efficient manner possible. The Community Plan is aimed toward maintaining a compact urban form, preserving surrounding agricultural lands.

The Plan area encompasses 857 acres between the Turlock Irrigation District Lateral Number 2-1/2 on the north and Keyes Road on the south. Faith Home Road serves as the community's western boundary. Washington Road serves as the community's eastern boundary. The majority of commercial and residential land uses lie east of State Route 99 while industrial uses are located to the west of State Route 99.

New residential development is targeted for the community's northern and eastern areas. The Community Plan also includes land designated as Urban Transition. This land is presently under Williamson Land Conservation Act contract. Should the Williamson Act contracts not be renewed in the future, the land may be developed as Low-Density Residential.

The Community Plan encourages the development of commercial areas which conveniently serve residential population, provide employment opportunities, form an attractive segment of the community and contribute to the County's tax base. Commercial development opportunities are provided at the northwest intersection of Washington Road and Keyes Road, and at the planned intersection of Faithhome Road and Hollywood Drive. In addition, the Keyes Community Plan designates land adjoining Golden State Boulevard, Keyes Road, and State Route 99 for highway commercial development. Industrial uses are primarily located west of State Route 99.

Table 1 provides a summary of land uses within the Keyes Community Plan area.

**Table 1: Keyes Community Land Use Profile**

Land Use	Development Acreage	Vacant Land	Total Acreage	Percent of Total
Low Density Residential (LDR)	191	159	350	41%
Medium Density Residential (MDR)	57	34	91	10%
Medium High Density Residential (MHDR)	17	13	30	3%
Commercial (C)	22	17	39	4%
Highway Commercial	18	90	108	13%
Industrial (I)	52	32	84	10%
Planned Industrial (PI)	33	7	40	5%
Urban Transition (UT)	-	48	48	6%
Parks*	5	20	25	3%
Schools**	12	30	42	5%
<b>Total</b>	<b>407</b>	<b>450</b>	<b>857</b>	<b>100%</b>

**Notes:**

*\*Parks vacant land acreage is based on a calculation need of 3 acres/1,000 residents projected in the Community Plan. Vacant parkland is representative of the Community Plan “Proposed Parks” symbol which denotes general location.*

*\*\*Schools vacant land acreage includes the planned middle school to be developed adjacent to Washington Road, and for on additional elementary school that will be needed.*

**Circulation.** The Community Plan identifies the location and extent of existing and proposed major roads, collector streets and local streets, as well as bikeways and rail lines. The Keyes Road interchange provides a vital link to the community from State Route 99. Keyes Road, Faith Home Road, Rohde Road/7<sup>th</sup> Street, Washington Road and Esmail Avenue are the community’s primary roadways. Non-motorized transportation is encouraged via a system of recreational trails and bicycle lanes that connect the community’s residential neighborhoods with retail centers, recreational and school facilities, and other public facilities.

**Public Services**

**Wastewater Collection and Treatment.** The Keyes Community Services District provides wastewater collection. Wastewater is conveyed to the City of Turlock wastewater treatment plant for treatment. Population growth in Keyes has been impeded due to capacity limitations of the sewer interceptor between Keyes and the City of Turlock wastewater treatment plant. Wastewater collection system improvements are underway to improve delivery of wastewater to the City of Turlock wastewater treatment plant.

**Water Service.** The Keyes Community Services District provides water service to the Keyes community. Domestic water is supplied by wells that pump groundwater. The groundwater is treated at the well head prior to being conveyed to customers.

**Law Enforcement.** Law enforcement is provided by the Stanislaus County Sheriff's Department. The County maintains a Sheriff's substation within the Keyes community. The California Highway Patrol shares space with County's sheriff's Department in the sub-station located on 7<sup>th</sup> Street.

**Fire Protection.** The Keyes Fire Protection District provides fire protection and paramedic services to the Keyes and surrounding areas. The District is a volunteer fire department. The average response time is two minutes.

**Schools.** Keyes is located within the Keyes Unified School District and the Turlock Joint Union High School District. The Keyes Unified School District has three schools, one charter school (K-8), one elementary school (K-8) and one pre-school all located on one campus site. Improvements are underway for a new middle school (Grades 6 – 8). The new middle will be located in northeast section of the Community Plan area, adjacent to Washington Road. The Community Plan diagram depicts the general location of a future elementary school site. High school-aged students (Grades 9 – 12) currently attend Turlock High School. Construction is underway for a new high school (Pitman High School) between Taylor Road and Christofferson Parkway. Once completed, it is anticipated that Keyes' high school-aged students will attend Pitman High School.

**Parks and Recreation.** The County provides and maintains one park facility within the community of Keyes. The community's current parkland inventory does not meet the County standard of 3 acres of parkland per 1,000 residents needed to support the community's present population. The Community Plan includes expanding Hatch Park into a 15 acre community park. The Community Plan also depicts the general location of future neighborhood park sites.

***THIS PAGE INTENTIONALLY LEFT BLANK***

## **Goals, Policies and Implementation Measures**

The following goals, policies and implementation measures are directed specifically toward the Keyes community and are intended to guide development within the Keyes Community Plan area:

### **GOAL ONE**

Achieve a harmonious relationship between the urban environment and surrounding agricultural setting.

### **POLICY ONE**

Provide a land use pattern that is compatible with surrounding land uses and which provides an effective transition between the built environment and agricultural uses along the periphery of the community.

### **POLICY TWO**

Discourage the designation/rezoning of residential land uses on land sharing a boundary with agriculture designated lands outside the Community Plan area.

### **POLICY THREE**

Provide adequate setbacks and/or non-residential improvements between residential development and adjacent agricultural land uses outside the Community Plan area.

### **POLICY FOUR**

Cooperate with the City of Ceres to the north and the City of Turlock to the south in establishing definitive community separator policies/implementation measures.

### **IMPLEMENTATION MEASURES**

1. Residential land use designations/rezoning that share a boundary with agricultural designated lands outside the Community Plan area shall demonstrate that a 200-foot building setback or other comparable development setback can be provided. Setbacks may include physical improvements such as roads and canals.
2. Commercial, Highway Commercial, and Planned Industrial development shall be buffered from adjacent agricultural land uses outside the Community Plan area by landscaping elements.

***THIS PAGE INTENTIONALLY LEFT BLANK***

## **GOAL TWO**

Improve the visual appearance of the Keyes community.

### **POLICY ONE**

Encourage the development of identifiable community boundaries to establish a sense of community identity.

### **POLICY TWO**

Encourage the development of “Gateway” treatments at major entryways to the community.

### **POLICY THREE**

Encourage the upgrading, beautification and revitalization of existing commercial areas along 7<sup>th</sup> Street.

### **POLICY FOUR**

Develop and Implement Design Guidelines for new development and for revitalization of existing development within Keyes.

### **POLICY FIVE**

Promote alternative design solutions to reduce the negative visual impact of walled developments within Keyes.

### **IMPLEMENTATION MEASURES**

1. The County should adopt Design Guidelines for the Keyes community. The guidelines should address residential subdivision design and connectivity, non-residential development, and design/establishment of a gateway/entry features for Keyes.
2. “Gateway” treatments should be established at the State Route 99/Keyes Road Interchange, and at Rohde Road and the crossing of the Turlock Irrigation District’s Upper Lateral No 2 ½.
3. Develop positive, high quality landscaped edges along State Route 99 and major roads leading into the community.
4. The County shall approve development proposals which include walls only if walls are necessary in order to mitigate the negative impacts of noise, visual separation from traffic, or to provide a barrier between incompatible land uses. Where walls are necessary, the County shall require separation from the roadway by a curb-adjacent sidewalk and a six-foot landscaped planter strip. A combination of walls, berming, and vegetation is considered more desirable than walls used alone.

***THIS PAGE INTENTIONALLY LEFT BLANK***



## **GOAL THREE**

Encourage attractive and orderly development which preserves a small town atmosphere.

### **POLICY ONE**

Provide a diverse community that integrates residential, commercial, and industrial land uses supported by public facilities.

### **POLICY TWO**

Create an enhanced streetscape environment through the use of landscape and pedestrian access along arterial and collector streets.

### **POLICY THREE**

Medium and High Density Residential should be located along collectors, and be designed and oriented in order to function as part of the overall neighborhood.

### **POLICY FOUR**

Provide adequate lands to accommodate the development of commercial areas which will conveniently serve current and future residential needs.

### **POLICY FIVE**

Minimize conflicts between industrial and planned industrial land uses by concentrating industrial activity west of State Route 99.

### **POLICY SIX**

Provide convenient and accessible neighborhood commercial areas within the community to minimize vehicular trips needed for frequently used retail services.

### **POLICY SEVEN**

Multi-family residential land uses shall be developed with a balance of open space, landscaping, and shall be accessible to commercial and recreational areas and public transportation facilities.

### **IMPLEMENTATION MEASURES**

1. Commercial development shall be consistent in scale and character with surrounding neighborhood.
2. Commercial sites shall be developed in such a manner to not preclude direct access from residential areas for pedestrian and bicycle traffic.
3. County shall encourage and seek the revitalization of existing housing stock within the central core of the community.

4. County shall encourage and assist the commercial revitalization of 7<sup>th</sup> Street.
5. Walled and isolated residential enclaves shall be discouraged.
6. Residential areas shall be designed to create a pattern of activity that promotes community interaction within and with abutting neighborhoods.
7. Parks and schools shall be located and designed as neighborhood focal points.
8. Residential rear yards with walls shall be discouraged along collector streets within the interior of the community to avoid walled subdivisions. In situations where collectors with walls adjoin residential areas, cul-de-sacs should be used to create wall openings with pathway connections to encourage pedestrian access.
8. Development adjacent to Turlock Irrigation District Upper Lateral No 2½ shall maintain an open edge along the Lateral rather than backing against the Lateral.

## **GOAL FOUR**

Promote highway-oriented commercial development in the State Route 99 corridor.

### **POLICY ONE**

The County shall encourage the location of businesses and services (e.g., restaurants, service stations, lodging) in the State Route 99 corridor to serve the traveling public and local residents.

### **IMPLEMENTATION MEASURES**

1. Designate land adjacent to the State Route 99/Keyes Road Interchange with good highway visibility and access as Highway Commercial. Permitted uses shall be those determined by the County to be supportive of the overall goals and policies of the Keyes Community Plan.
2. Limit development adjoining State Route 99/Keyes Road Interchange to large sites and non-residential uses with generous landscaping.
3. The County shall designate land in the Golden State Boulevard/Keyes Road/State Route 99 Interchange corridor area as Highway Commercial.

***THIS PAGE INTENTIONALLY LEFT BLANK***

## **GOAL FIVE**

Provide an interconnected system of streets and roads to distribute traffic and meet the circulation needs of the community.

### **POLICY ONE**

The County should promote development of a traditional grid circulation system that distributes traffic, provides connectivity and offers multiple-route choices for motorists, as portrayed on the Keyes Community Plan diagram.

### **POLICY TWO**

Open street patterns that create a network of circulation connections with multiple points of ingress and egress are encouraged.

### **POLICY THREE**

All roadways shall be designed to complement the urban development pattern and coordinate with pedestrian, bicycle and transit routes.

### **IMPLEMENTATION MEASURES**

1. The County shall evaluate development proposals for conformance with the circulation system depicted on the Keyes Community Plan diagram.
2. Recognizing the community's land use pattern, limited number of continuous north-south and east-west streets will result in less than acceptable service standards on a small number of streets, the following roads shall be extended and designated as Collectors as depicted on the Community Plan:
  - a) Esmail Avenue shall be extended to Washington Road;
  - b) Starlite Drive shall be extended to Washington Road; and
  - c) Washington Road shall be extended to Keyes Road.

The following local roads shall be extended to improve continuous north-south and east-west circulation as depicted on the Community Plan:

- a) Maude Avenue shall be extended to Washington Road;
- b) Anna Avenue shall be extended to Washington Road;
- c) Jennie Avenue shall be extended to future Starlite Drive extension; and
- d) Stella Avenue shall be extended to future Starlite Drive extension.

***THIS PAGE INTENTIONALLY LEFT BLANK***

## **GOAL SIX**

Provide for the non-motorized transportation needs of the Keyes community.

### **POLICY ONE**

Provide safe and convenient pedestrian and bicycle facilities to various destinations throughout the community of Keyes.

### **POLICY TWO**

Provide pedestrian and bicycle facilities that link community residents to schools, parks, civic facilities and the community's retail centers in accordance with the Keyes Community Plan diagram.

### **POLICY THREE**

Community bicycle facilities shall connect to regional bicycle facilities.

### **IMPLEMENTATION MEASURES**

1. Develop multi-purpose trail adjacent to the Turlock Irrigation District Lateral 2½ to promote walking, cycling and other non-motorized means of transportation.
2. The County shall explore a cooperative agreement with the Turlock Irrigation District to use Lateral 2½ right-of-way/easement for multi-purpose recreational trail, as identified on the Keyes Community Plan.
3. Bicycle facilities shall be included as part of road improvement projects where said roadways are identified as bike lanes on the Keyes Community Plan.

***THIS PAGE INTENTIONALLY LEFT BLANK***



## **GOAL SEVEN**

Provide for the recreational needs of the residents of the Keyes community.

### **POLICY ONE**

The County shall support expansion of Hatch Park as a community park.

### **POLICY TWO**

The County should acquire additional parkland, pursuant the Keyes Community Plan, to meet the future parkland needs of the Keyes community. Total parkland inventory should be consistent with the County standard of 3 acres of parkland per 1,000 residents.

### **IMPLEMENTATION MEASURES**

1. The County shall acquire lands to the north and east of Hatch Park to accommodate expansion of the Hatch Park site to promote the development of a 15+ acre community park.
2. The County, in conjunction with the Keyes Municipal Advisory Committee and other interested groups, shall work to upgrade and expand the facilities at Hatch Park to include facilities normally associated with a community park (e.g., baseball fields, community center, soccer fields).

***THIS PAGE INTENTIONALLY LEFT BLANK***

## **Appendix I-A6**

# **KNIGHTS FERRY COMMUNITY PLAN**

Adopted by the Stanislaus County Board of Supervisors

**JUNE 23, 1987\***

*\*A technical update to population statistics, service providers, and conditions in and surrounding the community were adopted on August 23, 2016, as part of the 2015 General Plan Update. The 2015 update also incorporated into the Community Plan information from the June 23, 1987, adopted Support Documentation to the Stanislaus County General Plan.*

***THIS PAGE INTENTIONALLY LEFT BLANK***

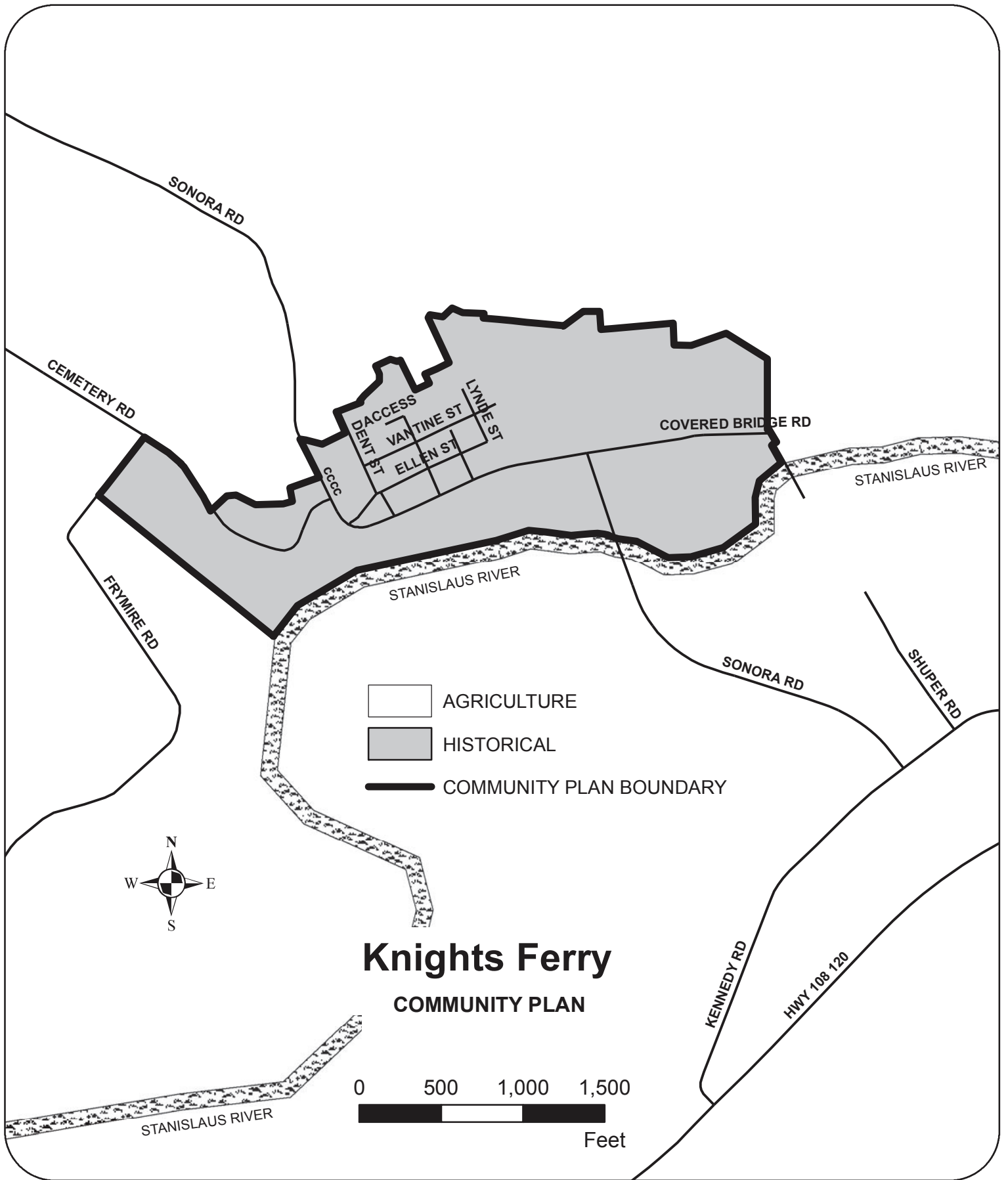

# Knights Ferry

## COMMUNITY PLAN

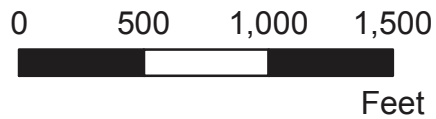

***THIS PAGE INTENTIONALLY LEFT BLANK***

## **KNIGHT'S FERRY COMMUNITY PLAN**

### **Description of Knights Ferry**

The community of Knights Ferry is located on the east side of Stanislaus County on the north bank of the Stanislaus River. It lies just north of the intersection of State Highway 108/120 and Kennedy and Sonora Roads.

### **History**

Land within Stanislaus County north of the Stanislaus River was, until 1860, part of San Joaquin County. At that time, Stanislaus County Supervisors recognized that the community of Knights Ferry was prosperous and booming. Therefore, to add to the tax revenue of the County, an assembly bill was introduced and signed annexing that portion to Stanislaus County.

In 1862, Knights Ferry became the seat of government for Stanislaus County and remained so for nine years. During this period, the community enjoyed steady growth and flourished with economic activity. With the decline in mining, ravages of fire, changes in transportation, and relocation of the County seat to Modesto, Knights Ferry became a sleepy hamlet steeped in history and character.

Knights Ferry is recognized both state and nationwide. In California it is Registered Landmark Number 347 and in December, 1975, it was designated a National Historic Landmark and listed in the National Register of Historic Places.

### **Land Use**

Knights Ferry consists predominantly of older single-family residences with some older commercial and fraternal structures. Large parcels to the north of the community are under Williamson Act contracts.

### **Available Urban Services**

The Knights Ferry Community Services District provides public water, but there is no sanitary sewer system. The Oakdale Rural Fire Protection District and the Stanislaus County Sheriff's Department provide fire and police protection services, respectively.

### **Transportation**

Highway 108/120 runs parallel to Knights Ferry south of the Stanislaus River. The intersection at Kennedy and Sonora Roads provides access to Knights Ferry.

### **Development Potential**

It is not anticipated that Knight's Ferry will experience significant growth in the coming years. Lack of sanitary sewer, existing Williamson Act contracts to the north, the Stanislaus River on the south, and the community's desire to retain its historical character will keep its growth to a minimum. In the event that development is proposed within the historical community of Knight's Ferry, it must comply with the building standards in Appendix I-B1- Knights Ferry Historical Standards of the Land Use Element of the General Plan.

***THIS PAGE INTENTIONALLY LEFT BLANK***



# Appendix I-A7

## LA GRANGE COMMUNITY PLAN

Adopted by the Stanislaus County Board of Supervisors

JUNE 23, 1987\*

*\*A technical update to population statistics, service provides, and conditions in and surrounding the community were adopted on August 23, 2016, as part of the 2015 General Plan Update. The 2015 update also incorporated into the Community Plan information from the June 23, 1987, adopted Support Documentation to the Stanislaus County General Plan.*

***THIS PAGE INTENTIONALLY LEFT BLANK***

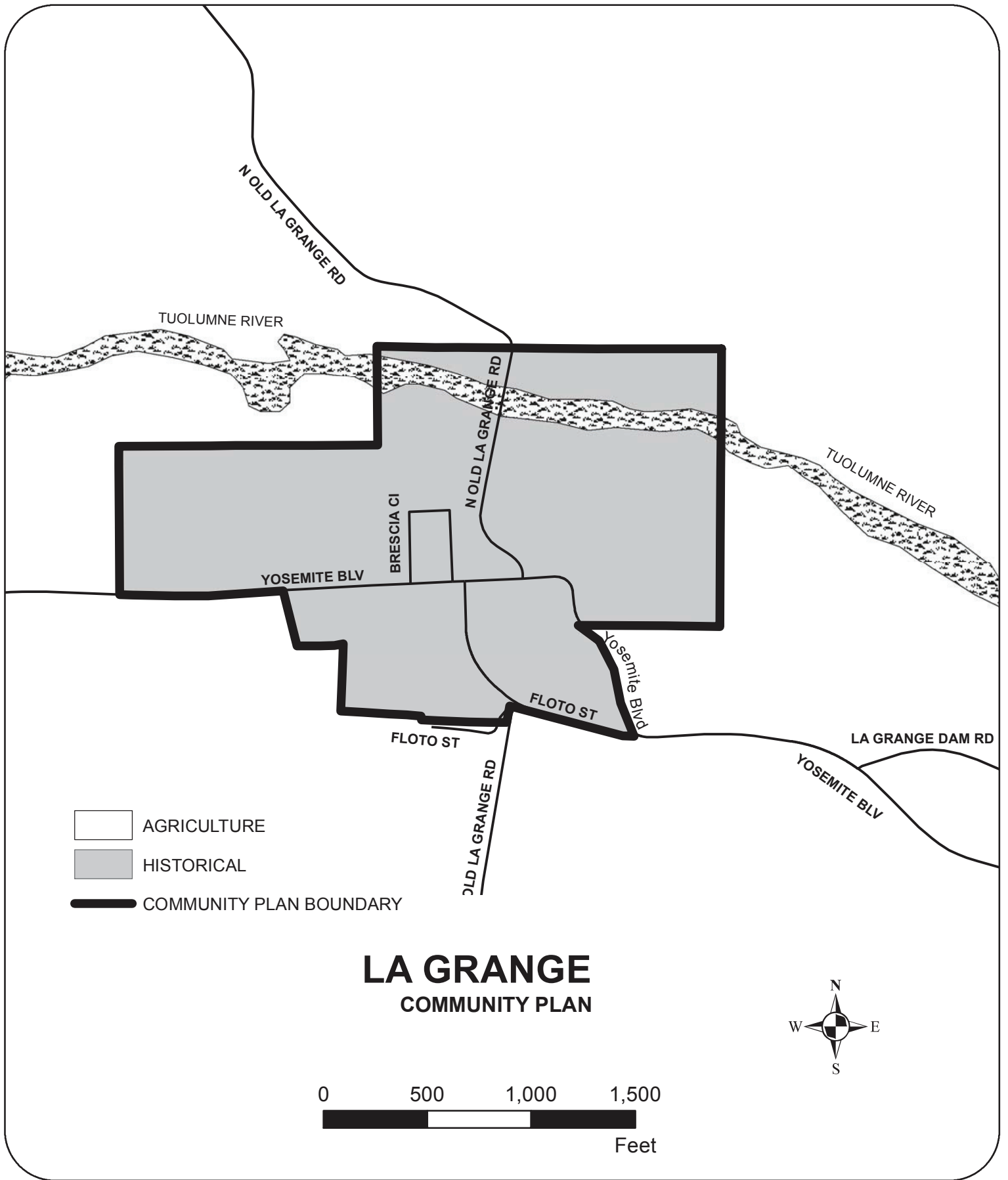

# LA GRANGE COMMUNITY PLAN

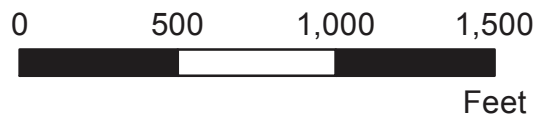

***THIS PAGE INTENTIONALLY LEFT BLANK***

## **LA GRANGE COMMUNITY PLAN**

### **Description of La Grange**

The community of La Grange straddles Yosemite Boulevard (State Highway 132) on the south bank of the Tuolumne River in the most easterly portion of Stanislaus County. The town of La Grange is located within an area of limited base (grazing and range land) agriculture.

### **History**

In the early 1850's, flooding along the Tuolumne River encouraged the inhabitants of French Bar to seek higher ground. The new community became known as La Grange, which is French for "the barn". In 1856, La Grange became the third location for the seat of Stanislaus County government and remained so for six years. The two major industries that have long been idle were mining and the Elam Dye sawmill. La Grange has been recognized as having State historical significance; therefore, is noted as a California State Registered Landmark.

### **Land Use**

La Grange consists of older single-family residences and commercial structures, variously mixed throughout the community.

### **Available Urban Services**

The Turlock Irrigation District provides public water, and the Stanislaus County Sheriff's Department provides police protection. Fire protection is provided by the Stanislaus Consolidated Fire District.

### **Transportation**

Highway 132 runs directly through town in an east-west direction.

### **Development Potential**

It is not anticipated that La Grange will experience any significant growth in the coming years. The present water system is lacking in the ability to serve additional customers, consequently, until the system is upgraded and expanded, future growth is seriously limited. In the event that development is proposed within the historical community of La Grange, Appendix I-B2 - La Grange Historical Standards of the Land Use Element of the General Plan should be consulted for building exterior design standards.

***THIS PAGE INTENTIONALLY LEFT BLANK***

## **Appendix I-A8**

# **SALIDA COMMUNITY PLAN**

Adopted by the Stanislaus County Board of Supervisors

AUGUST 7, 2007

*\*A technical update clarifying the integration of the 2007 Salida Area Planning, Road Improvement, Economic Development, and Farmland Protection Initiative and the terms of the development agreements governing the amended area was adopted on August 23, 2016, as part of the 2015 General Plan Update.*







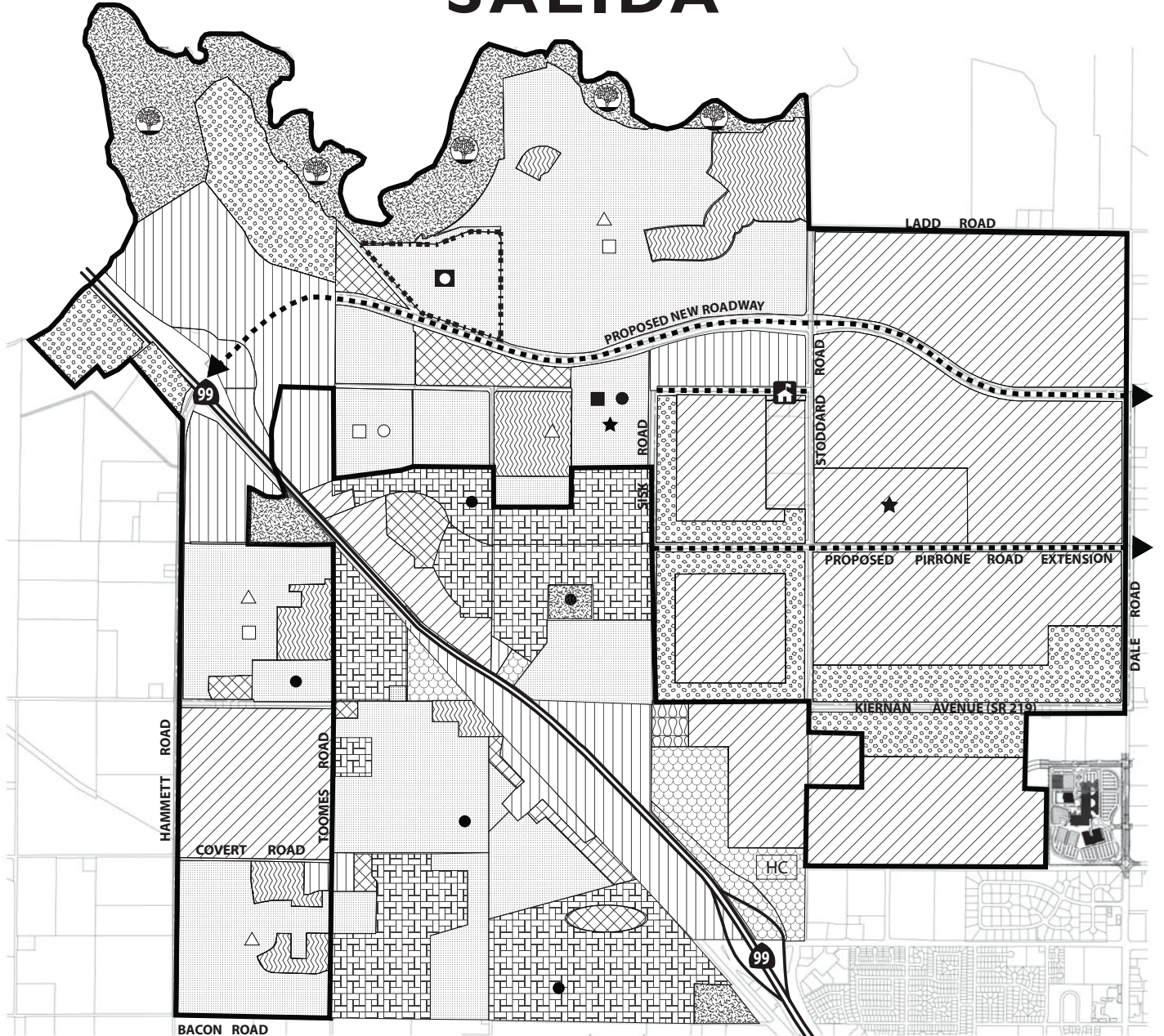



***THIS PAGE INTENTIONALLY LEFT BLANK***













# SALIDA







## LAND USES

-  Low Density Residential
-  Low Density Residential (Within Project Boundary)
-  Medium Density Residential
-  Medium High Density Residential
-  Business Park
-  Commercial
-  Industrial
-  Planned Industrial
-  Planned Development
-  Highway Commercial
-  Agricultural

## PARKS AND SCHOOLS

- | Existing  | Proposed  |                        |
|---|---|------------------------|
|  |  | Neighborhood Park*     |
|  |  | Elementary School*     |
|  |  | Middle School*         |
|  |  | High School*           |
|  |  | Stanislaus River Park* |

## PUBLIC FACILITIES

-  New Road
-  Special Treatment Area
-  Amendment Area Boundary
-  Existing Waste Water Treatment Plant\*
-  Proposed Fire Station\*



## COMMUNITY PLAN

***THIS PAGE INTENTIONALLY LEFT BLANK***

## **SALIDA COMMUNITY PLAN**

The Salida Community Plan (“Community Plan” or “Plan”) provides land use planning and guidance for development of approximately 4,600 acres of land in the Salida area. The Community Plan encompasses the existing community of Salida, which was part of the previously approved Salida Community Plan (the “Existing Plan” or “Existing Plan Area”), and an amendment area encompassing approximately 3,383 acres (the “Amendment Area”). The Amended Area consists of the Salida Area Planning, Road Improvement, Economic Development, and Farmland Protection Initiative (the “Initiative”) approved by the Board of Supervisors on August 7, 2007, and adopted by ordinance on August 17, 2007. The ordinance specifies that until the terms of the Development Agreement governing the Amended Area expire, the Initiative may be amended or repealed, to the extent permitted by law, by a majority of the voters of the County voting in an election held in accordance with state law. The terms of the Development Agreement expires twenty-five (25) years from the effective date of August 7, 2007 (*Expires: August 7, 2032*).

### **The Existing Plan Area**

The land use plan for the Existing Plan Area reflects both existing land use patterns and gathered information to guide future land use decisions. In formulating this plan, it was apparent that a substantial portion of the community had already developed in a way which has produced few areas of potential land use conflicts. The designations included within this plan are intended to, whenever possible, mitigate those impacts, or prevent them from occurring in the future. This will, hopefully, result in an attractive and efficient pattern of living and working areas. In the event that development is proposed within the redevelopment area of Salida, Appendix I-B3 – Salida Design Guidelines of the Land Use Element of the General Plan should be consulted for development standards.

### **The Amendment Area**

The Community Plan provides land use and development guidance for the Amendment Area that promotes harmonious integration of the Existing Plan Area with new development planned within the Amendment Area. The land uses, goals, and policies of the Community Plan promote job creation, retail opportunities, and tax generation, while providing for improved vehicular and non-vehicular circulation, expanded recreational amenities, expanded housing choice, preservation of open space, effective transitions between urban and agricultural environments, and substantial infrastructure improvements within the Amendment Area. New development within the Amendment Area will be implemented through the Salida Community Plan Zoning District, which requires the adoption of a discretionary non-legislative Development Plan (“Development Plan”) prepared according to the regulatory zoning requirements of the District.

### **Amendment Area Purpose**

One of the primary purposes of the Amendment Area is to provide for a mix of land uses that can facilitate the Salida community’s financial and fiscal self-sufficiency. Building upon this purpose, and other goals and policies, the Amendment Area strives to create local jobs and commercial opportunities with significantly improved regional vehicular circulation and infrastructure, supported by complementary and integrated housing that expands the community’s range of residential offerings. Capital facility, and service needs generated by new development in the Amendment Area should be financed by new development. To allow sufficient time for proper infrastructure planning and development, no new residential units in the Amendment Area shall be occupied prior to January 1, 2010.

## **Land Use and Land Use Designations**

Land uses shown for the Amendment Area are consistent with designations contained in the County General Plan. However, a new land use designation, Business Park, has been added for this area. The General Plan land use designations applicable within the Amendment Area include: Low-Density Residential, Medium-Density Residential, Medium High-Density Residential, Commercial, Planned Industrial, Business Park, and Agriculture. Table 1, Salida Community Plan Amendment Area Land Use Designations, shows the proposed Amendment Area land uses and their associated acreages. Refer to the Salida Community Plan map for a map of land uses within the Amendment Area. The Amendment Area represents a blueprint for the expansion of Salida and is meant to take a comprehensive view of land uses in order to prevent piecemeal planning. In order to offer a long-term planning approach, non-agricultural land use designations are applied to lands which may still be subject to Williamson Act contracts. However, the provisions of the Salida Community Plan Zoning District should require that until such time as contracts are terminated, lands encumbered by a Williamson Act contract shall remain subject to the zoning restrictions found within the County's A-2 zoning regulations.

The Board of Supervisors may, at its discretion, approve minor modifications to the boundaries and location of the land designated Low-Density Residential, Medium-Density Residential, Medium High-Density Residential, or Agriculture within the Amendment Area, and approve rezonings which implement such modifications, provided such modifications preserve the overall intent of the Community Plan and the total acreage devoted to the Low-Density, Medium-Density and Medium High-Density Residential land use designations, as set forth in Table 1, does not increase or decrease by more than ten percent (10%).

In addition, the Business Park designation, as created herein, is intended to provide land use flexibility in order to support the creation of a first-class modern business park. Therefore, the Board of Supervisors may, at its discretion, re-designate land within the Amendment Area from Planned Industrial to Business Park along with rezonings to implement said modifications without limitation. This discretion is reserved for the Board of Supervisors in acknowledgment that the market demand for Business Park uses may increase over time, thereby warranting the broader range of uses and land use configurations offered by the Business Park designation.

To effectively implement the Planned Industrial, Business Park, or Commercial Land Use designations within the Amendment Area, the Board of Supervisors may also, at its discretion, rezone land zoned as SCP-C-1, SCP-C-2, SCP-PI, or SCP-IBP, to Planned Development. The Planned Development district as provided for in Chapter 21.40 of the County Code would allow for modification of requirements established by the SCP district and diversification in the relationship of different uses, buildings, structures, lot sizes and open spaces, while ensuring compliance with, and implementation of, the Community Plan. Such flexibility would be used to promote development of modern retail, business park, and industrial park developments.

Finally, if the potential adverse environmental impacts associated with the current Planned Industrial or Business Park land use designations, as identified in an Environmental Impact Report, could be reduced or eliminated by alternative land use designations, the Board of Supervisors retains the discretion to make changes to the Planned Industrial or Business Park land uses, including conforming rezonings.

An illustrative conceptual plan for the Amendment Area is included in the Community Plan as Illustration 1 and is provided for illustrative purposes only. The precise design, location of uses, and amenities will be established by discretionary non-legislative Development Plan approval.

Table 1

<b>SALIDA COMMUNITY PLAN AMENDMENT AREA LAND USE DESIGNATIONS</b>		
<b>Land Use Designation</b>	<b>Zoning</b>	<b>Total Acreage</b>
Planned Industrial	SCP-PI	1,259
Business Park	SCP-IBP	490
Commercial	SCP-C-1 SCP-C-2	280
Low-Density Residential	SCP-R-1	802
Low-Density Residential-Special Treatment Area	SCP-R-1- ST	64
Medium-Density Residential	SCP-R-2	187
Medium High-Density Residential	SCP-R-3	57
Agriculture	SCP-A-2	244
<i>Total Acres</i>		<b>3,383</b>

***THIS PAGE INTENTIONALLY LEFT BLANK***



**LEGEND**

Description	Description
Business Park	Public Uses
High Visibility Business Park	Private School
Commercial	Parks & Open Spaces
Planned Industrial	LDR
PI Reserve	MDR
Existing Salida Community	MHDR

# SALIDA COMMUNITY PLAN

SALIDA, CA

## ILLUSTRATION 1

***THIS PAGE INTENTIONALLY LEFT BLANK***



**Planned Industrial.** As part of an inter-jurisdictional effort, the County of Stanislaus and the City of Modesto developed the North Gateway Business Complex Master Development Plan in 2003. The goal of the plan is to help alleviate the existing jobs-housing imbalance in the County by promoting development of employment-generating industrial/business park uses in the area roughly bound by Ladd Road on the north, Dale Road on the east, Pelandale Expressway on the south, and Sisk Road on the west. The Planned Industrial designations shown to the east of Sisk Road within the Amendment Area are consistent with the intent of the North Gateway Business Complex Master Development Plan.

Approximately 1,259 acres of land are designated as Planned Industrial. This represents approximately 37.2 percent of the Amendment Area. The majority of these lands are located in the northeastern portion of the Amendment Area. An area designated as Planned Industrial is located in the southwestern portion of the Amendment Area on land that includes an existing industrial use. Intended uses within the Planned Industrial designation are consistent with those defined in the General Plan.

**Business Park.** The Community Plan includes 490 acres that are designated Business Park. This represents approximately 14.5 percent of the total Amendment Area. This use is concentrated largely in the eastern portion of the Amendment Area, but two notable areas in the northwest portion of the Amendment Area, near the Hammett Road/State Route 99 interchange, also carry this designation.

The Business Park designation is intended to accommodate development of a full range of uses, including modern, employment-intensive uses. Principal development and employment-generating uses allowed within this designation include research, product development, professional office, commercial, and business services.

**Commercial.** The Community Plan includes 280 acres of land designated Commercial within the Amendment Area. This represents approximately 8.3 percent of the Amendment Area. The Commercial designation applies to Regional Commercial, Neighborhood Commercial, and Highway Commercial uses as described in the General Plan. A major regional commercial area is planned in the northwest corner of the Amendment Area on the east side of State Route 99. Neighborhood-serving commercial uses are located at the southwest corner of the Covert Road/Toomes Road intersection and between Sisk Road and Stoddard Road just south of the planned expressway. New highway commercial uses are located west of State Route 99 near the Hammett Road/State Route 99 interchange.

**Table 2**

<b>SALIDA AMENDMENT AREA ANTICIPATED EMPLOYMENT GENERATION</b>			
<b>Land Use</b>	<b>Acres</b>	<b>Jobs/Acre<sup>1</sup></b>	<b>Total Jobs</b>
<b>Business Park</b>	<b>490</b>	<b>25<sup>2</sup></b>	<b>12,250</b>
<b>Manufacturing/Industrial/Warehousing, etc.</b>	<b>1,259</b>	<b>7</b>	<b>8,813</b>
<b>Neighborhood, General, and Highway Commercial</b>	<b>280</b>	<b>24</b>	<b>6,720</b>
<b>Total</b>	<b>2,029</b>	<b>13.7</b>	<b>27,783</b>

<sup>1</sup> Source: Stanislaus County Economic and Workforce Alliance

---

<sup>2</sup> Weighted average number of jobs per acre between Business Park and High-Visibility Business Park

**Residential.** The Amendment Area affords substantial opportunity for new residential development with a neighborhood orientation. The Amendment Area includes 866 acres of land designated Low-Density Residential, 187 acres designated Medium-Density Residential, and 57 acres designated Medium High-Density Residential, for a total of 1,110 acres of new residential development. Land designated for residential uses represents approximately 32.8 percent of the total Amendment Area. The new residential areas are generally located in the southwestern and northern portions of the Amendment Area.

Public facilities, parks, and schools are conditional uses within areas designated as Low-Density Residential. Accordingly, approximately 118 acres of the land designated Low-Density Residential within the Amendment Area are either occupied by existing schools or owned by a school district for which a school is planned and are therefore not expected to result in additional units beyond the 5,000 units shown in Table 3. Additionally, 64 acres of land now owned by the Salida Sanitation District on which it operates the Salida Wastewater Treatment Plant are designated Low-Density Residential. Build-out of this land with residential uses may or may not occur. If the Salida Sanitation District determines that it will continue to operate the existing plant, modify the plant, and/or expand the plant in the future to meet its needs, this could preclude build-out of all 64 acres with residential units, though some portion of the land may retain capacity for residential development. As a result, the maximum number of units and the total projected population increase shown in Table 3 could be incrementally lower.

Single-family homes at a density of up to eight dwelling units per net acre may be developed on land designated Low-Density Residential. The actual development density is likely to be about 4.5+/- dwelling units per net acre. Detached single-family homes, duplexes, and triplexes at densities of up to 14 units per net acre are permitted on land designated Medium-Density Residential. An average density of about 10+/- dwellings units per net acre is anticipated. Densities up to approximately 25 dwelling units per net acre are permitted on land designated Medium High-Density Residential. An average density of about 23+/- dwelling units per net acre is anticipated. Table 3, Projected Residential Build-Out and Population, shows that a total of approximately 5,000 new dwelling units could be accommodated within areas designated Low-, Medium- and Medium High-Density Residential use at build-out. The local population would increase by about 15,063 people with build-out of the residential designated portions of the Amendment Area. Including the population of the existing community, the projected total population within the Community Plan boundary would be 29,063 persons at build-out of the Amendment Area.

**Table 3**

<b>Projected Residential Build-Out and Population</b>				
<b>Land Use Designation</b>	<b>Total Gross</b>	<b>Average Dwelling</b>	<b>Total Dwelling Units</b>	<b>Population Accommodated</b>
<b>Low-Density Residential</b>	<b>866</b>	<b>4.5</b>	<b>2,754</b>	<b>8,299</b>
<b>Medium-Density Residential</b>	<b>187</b>	<b>10.0</b>	<b>1,306</b>	<b>3,933</b>
<b>Medium High-Density Residential</b>	<b>57</b>	<b>23.4</b>	<b>940</b>	<b>2,831</b>
<b>TOTAL</b>	<b>1,110</b>		<b>5,000</b>	<b>15,063</b>

1. Net acreage is approximate based on an assumption that 30% of the gross acreage will be occupied by parks, roads, school sites, sidewalks, and utilities.
2. Based on average of 3.01 persons per household.

**Agriculture.** The County currently applies the Agriculture land use designation to areas identified as suitable for open space or recreational use. Within the Amendment Area, this designation applies solely to the proposed Stanislaus River Park, which comprises 244 acres, or approximately 7.2 percent of the Amendment Area. This designation is not intended to accommodate agricultural activities within the Community Plan boundary.

The Stanislaus County Parks Development Plan states that regional parks are an important component of the County-wide parks program. The Stanislaus County Parks Development Plan suggests that parks which preserve river and riparian areas, which are significant natural resources, should be a focus. Though the Stanislaus County Parks Development Plan states that the overall acreage of existing regional parks in the County is adequate to serve future populations, to meet the intent of the Community Plan for providing expanded recreation resources and to help preserve valuable natural resources, the Amendment Area includes an approximately 244-acre river park along the Stanislaus River. The river park comprises lands within habitat and flood easements along the river that are controlled by the U.S. Army Corps of Engineers. The river park concept is to preserve and restore natural conditions close to the river and to locate passive recreational activities such as picnicking, bird-watching, walking, jogging, bicycling, and supporting structures such as restrooms and parking facilities, etc. at distances that are progressively farther from the river. Active recreational facilities could be considered.

It is expected that developers of new projects within the Amendment Area would prepare a park plan, as part of the Development Plan process, for the river park and would fund improvements needed to implement the park plan.

## **Circulation**

**Circulation Concept.** Existing and planned roadways should comprise a roadway network that serves the existing community and provides connectivity to regional transportation corridors. The existing circulation system and proposed circulation facilities and improvements should be fully integrated. Roadway segments and alignments should promote even dispersal of traffic throughout the Community Plan area. For example, industrial traffic should be routed from the eastern portion of the Amendment Area to a new expressway. Right-of-way for the Hammett Road interchange is needed to accommodate interchange improvements required to accommodate additional traffic generated by new development. A Project Study Report for the Hammett Road Interchange is currently under preparation. A Project Study Report shall be approved for the Hammett Road Interchange prior to approval of tentative maps and development permits for lands located within the interchange study area of the Project Study Report. Right-of-way for any interchange improvement is required to be protected and incorporated into any Development Plan for lands contained within the interchange study area.

The new vehicular circulation system should include a number of major improvements:

- Construction of that portion of a new expressway located within the Amendment Area to facilitate traffic flow east to west and which connects to the State Route 99 / Hammett Road interchange;
- Modification of an existing State Route 99 interchange at Hammett Road;
- Extension of Pirrone Road east from Sisk Road;
- Widening and improvement of Sisk, Stoddard, Kiernan, Dale, Toomes, Hammett, and Bacon roads;

- Facilitation of circulation to the area designated Planned Industrial that is located south of Kiernan Avenue; and
- Construction of local roadways and collectors throughout the Amendment Area to promote efficient and safe circulation.

**Conceptual Roadway Classifications/Sections.** New roadways within the Amendment Area must be designed to accommodate a variety of vehicle types, volumes, speeds, and safety conditions. To this end, several roadway types are proposed. These range from an expressway road classification, where the proposed right-of-way width is up to 224 feet, to a local street classification with a right-of-way width of approximately 50 feet. Several of the roadway types incorporate Class II bicycle or Class I separated dual-use pedestrian/bicycle paths to provide for non-motorized transportation connectivity throughout the Amendment Area. In most cases, the conceptual sections differ from standard road sections utilized by the County and where different, the conceptual road standards are unique to the Amendment Area. Conceptual roadway classifications and types are as follows:

- **Expressway:** An expressway running east to west that connects the eastern portion of the Amendment Area and the communities of Oakdale, Riverbank, Modesto, and beyond with access to the State Route 99 / Hammett Road interchange is planned. The expressway would improve access to State Route 99 from the noted communities and link new development within the Amendment Area to the highway. New development within the Amendment Area is expected to provide funding needed to construct the portion of the expressway located within the Amendment Area. Funding to construct portions of the expressway that extend east from the eastern Amendment Area boundary must be acquired and improvements constructed by other parties. The expressway could ultimately be 10 lanes wide, with a right-of-way width of approximately 224 feet. The expressway would likely be constructed in phases and widened over time to respond to demand for increased capacity, as determined by traffic studies, and available funding.
- **Hammett Road:** The right-of-way width for Hammett Road north of Ciccarelli Road would measure 105 feet and would include 6 travel lanes (3 in each direction). A 12-foot Class I dual-use pedestrian/bicycle trail would be located within a 50-foot landscape buffer to the east. The total separation between new development and agriculture to the west of the Amendment Area would total 155 feet, inclusive of the landscape buffer. The right-of-way width for Hammett Road from Ciccarelli Road to Bacon would measure 81 feet and include 4 travel lanes (2 in each direction). A 12-foot Class I dual-use pedestrian/bicycle trail would be located within a 50-foot landscape buffer to the east. The total separation between new development and agriculture to its west inclusive of the right-of-way width and landscape buffer would be 131 feet.
- **4-Lane Backbone Roads:** The following roadways are classified as 4-Lane Backbone Roads: Dale Road, Stoddard Road, Quinturn Lane and Pirrone Road. Right-of-way width for these road segments measures 125 feet and includes either an 8-foot Class I dual-use bike trail and sidewalk or a 6-foot Class II bike lane and 5-foot separated sidewalk on each side of the street.
- **Sisk Road:** Sisk Road would measure 110 feet in total public right-of-way width. The current public right-of-way width for Sisk Road totals 50 feet. New development would improve 60 feet of new right-of-way width on the eastern side of the street.

- Kiernan Avenue Parkway: Kiernan Avenue west of Hwy. 99 from Hammett Road to the west property line of Salida Middle School would measure 81 feet in width and include 4 travel lanes. An 8-foot Class I dual-use bike trail and sidewalk would be located within a 31-foot landscape buffer to the south. Kiernan Avenue Parkway from the west property line of Salida Middle School to Toomes Road would measure 81 feet in width and include three travel lanes and a 5-foot separated sidewalk to the north. An 8-foot Class I dual-use pedestrian/bicycle trail would be located within a 31-foot landscape buffer.
- Bacon Road: Bacon Road right-of-way width would measure 72 feet and include four travel lanes and an 8-foot Class II dual-use bike path and sidewalk to the north.
- Arborwood Road: Arborwood Road right-of-way would measure 82 feet in width and include two travel lanes, a 5-foot Class II bike lane in each direction, and a 4-foot separated sidewalk on both sides of the street.
- Toomes, Ciccarelli, Covert, and Finney: Right-of-way for the named streets would measure 62 feet in width and include an 8-foot Class II bike lane, a 5-foot separated sidewalk on one side of the street, and an 8-foot Class I dual-use pedestrian/bicycle trail on one side of the street.
- Industrial Collectors: Right-of-way width for collector streets within land areas designated for planned industrial or business park land uses would total 80 feet and consist of 34 feet of travel lanes and a 6-foot attached sidewalk on each side of the centerline.
- Right-of-way width for local residential streets serving more than 50 homes would measure 56 feet and include a 5-foot separated sidewalk on both sides of the street. Right-of-way width for local residential streets serving fewer than 50 homes would measure 50 feet and include a 10-foot travel lane, an 8-foot parking lane, and a 4-foot attached sidewalk on each side of the street.

The Development Plans for new development shall specify the roadway classifications and standards required within each Development Plan boundary to ensure that the overall circulation network functions efficiently and effectively. Development Plans may include modifications or additions to the conceptual road standards noted above, with such modifications and additions subject to review and approval of County staff.

## **Neighborhood Parks and Trails**

**Neighborhood Parks.** Neighborhood parks are intended to serve residents within one-quarter to one-half mile, be within an appropriate walking or cycling distance, and be connected by a multi-use trail system where possible. The Stanislaus County Parks Development Plan suggests that neighborhood parks be provided at a ratio of at least three acres of park land for every 1,000 people. A population increase of 15,063 people is projected should the designated Low-Density, Medium-Density, and Medium High-Density new residential areas build-out within the Amendment Area to their maximum potential. If maximum build-out were achieved, 45 acres of neighborhood parks would be needed to meet County standards. Satisfaction of park provision requirements may also be met through payment of park in-lieu fees. However, given the need for local park facilities within local neighborhoods in the Amendment Area, it is anticipated that park requirements will be largely met through provision of park land. The Community Plan illustrates the general location of potential neighborhood park sites. Where possible, neighborhood parks are placed adjacent to new or existing schools. Co-location of parks and school facilities maximizes the recreational utility of both types of facilities; a full range of complementary recreational opportunities can be provided in one location.

Neighborhood park land may also be designed to serve the dual-uses of recreation and temporary storm water detention. This approach improves land use efficiency.

**Trails.** Community Plan policy requires that new development incorporate multi-use trails, pedestrian corridors, and bicycle facilities. Development Plans for new development must incorporate such improvements to demonstrate that new development is meeting the intent of the Community Plan that significant alternative transportation opportunities be provided to maximize community interconnectedness. Priority should be placed on linking neighborhoods with local neighborhood parks, the Stanislaus River Park, school facilities, and major employment centers. The Development Plans must include policy and guidance for the location and standards of trails, pedestrian facilities, and bicycle facilities.

A regional trail spanning the length of the Stanislaus River Park is planned and would be a valuable asset. Class I or Class II bicycle lanes should be incorporated into the design of new arterial and major collector roadways. Separated dual-use Class I pedestrian/bicycle facilities should also be considered for inclusion in the design of such roadways.

### **Schools**

With the increase in population in the Salida community, new schools will be needed to serve new local residents. It is anticipated that up to three new elementary schools and one new middle school will be required. The Community Plan shows the general locations proposed for new elementary school and middle school sites. These schools would complement the new Joseph Gregori High School, the Modesto Christian School, and the Salida Middle School, each of which is located within the Amendment Area. Each of the new schools is planned to include active recreational playfields and other amenities that will substantially expand availability of recreation facilities within the community.

### **Public Utilities and Facilities**

New public services and facilities will be needed to support new development within the Amendment Area and may also provide benefit to the existing Salida community. Examples of new public utilities include wastewater treatment service and water service. Facilities include sheriff or fire stations, utility substations, or other utility improvements such as water or wastewater treatment facilities. While provisions have been made for the location of such facilities within the Amendment Area, the Board of Supervisors retains discretion to allow such facilities to be located outside the Amendment Area.

**Emergency Response.** Emergency response and law enforcement services are provided by the Salida Fire Protection District and the Stanislaus County Sheriff's Department respectively. An additional fire station site may be needed to adequately serve emergency response needs of the community. A new fire station site has been generally designated for a location on Stoddard Road north of Pirrone Road as shown on the Community Plan. Final determination of a fire station site is within the purview of the Salida Fire Protection District and Stanislaus County.

**Wastewater Treatment.** The existing Salida Wastewater Treatment Plant must be expanded or upgraded and/or a new plant constructed to provide treatment capacity for new development. The existing plant site is designated for residential use, but is considered a special treatment area within which continued operation and expansion of the plant is permitted. If an additional treatment plant is needed, it could be located nearly anywhere within the Amendment Area. New wastewater treatment plants can be designed to substantially reduce the types of nuisances normally associated with more traditional facilities (i.e. odors, noise, etc.) and to be very land use efficient. A new plant with capacity to accommodate the new development could be constructed on about 8-12 acres of land. This enables flexibility in locating a new treatment facility because potential land use incompatibility concerns are substantially reduced. Given current requirements of the California Regional Water Quality Control Board, new wastewater treatment facilities must meet stringent environmental standards.

Because water is a limited resource, it is likely that a new plant (and possibly any upgrade to the existing wastewater treatment plant) would be designed to treat wastewater to a tertiary level. A significant volume of recycled water will be produced. Recycled water may be used for a variety of applications such as landscape irrigation, toilet flushing, etc. Use of recycled water would reduce demand for ground or surface water, thereby reducing the impact of new development on existing water sources.

The precise location of a new wastewater treatment facility, if one is needed, will be identified and incorporated into the Development Plan which guides development for that location. The Development Plan must address land use compatibility issues and identify measures to avoid or substantially reduce incompatibilities should incompatibilities be identified.

**Water Supply.** An adequate water supply must be secured and demonstrated for development in accordance with applicable law.



## **Appendix I-A9**

# **WESTLEY COMMUNITY PLAN**

Adopted by the Stanislaus County Board of Supervisors

JUNE 23, 1987\*

*\*A technical update to population statistics, service provides, and conditions in and surrounding the community were adopted on August 23, 2016, as part of the 2015 General Plan Update. The 2015 update also incorporated into the Community Plan information from the June 23, 1987, adopted Support Documentation to the Stanislaus County General Plan.*

***THIS PAGE INTENTIONALLY LEFT BLANK***

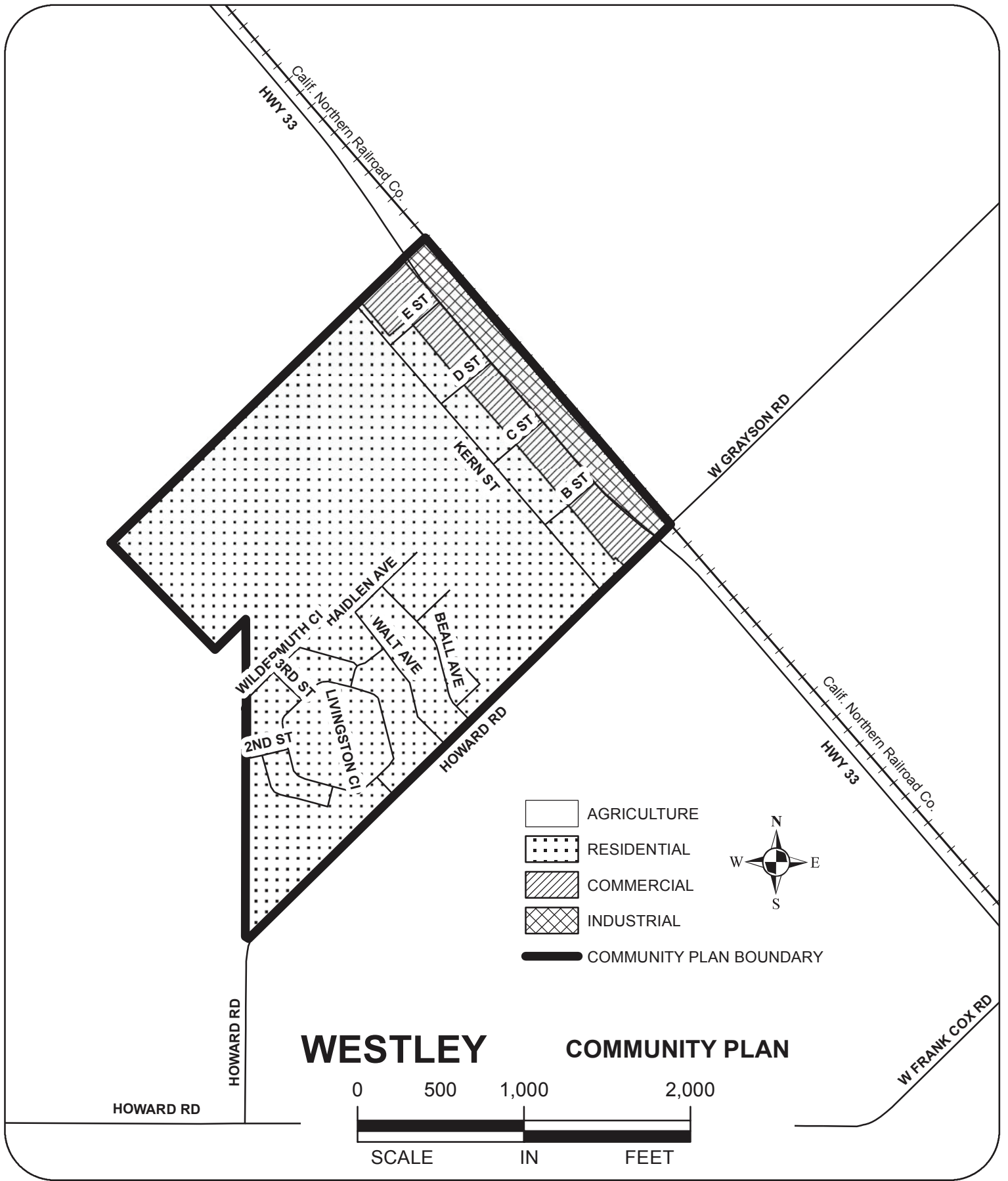

***THIS PAGE INTENTIONALLY LEFT BLANK***

## **WESTLEY COMMUNITY PLAN**

### **Description of Westley**

Westley is located on the west side of Stanislaus County at the intersection of Highway 33 and Grayson Road within an area of long-standing, intense agricultural use.

### **History**

In 1888, land was sold to the Pacific Improvement Company for the development of Westley. This company was the land development branch of the Central Pacific Railroad. When the railroad was built, a slow exodus of people and businesses from Grayson began populating the new community.

### **Land Use**

Westley consists primarily of single family homes. The Stanislaus County Housing Authority operates a complex of residences designed for low income and seasonal agricultural laborers. Along Highway 33 and the Southern Pacific Railroad are agricultural warehouses and packing sheds. On the west side of Highway 33 from Howard Road to "E" Street is the commercial area of Westley. The commercial and industrial areas serve both the community of Westley and the surrounding agricultural area. The community is adjacent to properties contracted by the Williamson Act; however, there are some parcels just west and northwest of the community not under this obligation.

### **Available Urban Services**

The West Stanislaus Fire Protection District provides fire protection to the community and surrounding rural area. Fire hydrants are located throughout the urbanized area. The Stanislaus County Housing Authority operates a wastewater treatment facility which serves the Housing Authority's Westley Migrant and Farm Labor Housing complex and provides sewer service to the Westley Community Service District on a contractual basis

### **Transportation**

Highway 33 bisects the town of Westley. Interstate 5 is only three miles to the west and can be reached via Howard Road and the McCracken Road interchange. The Southern Pacific Railroad runs parallel to Highway 33.

### **Development Potential**

The community of Westley has an estimated population of 83 residents within the District's boundaries. The Housing Authority's Migrant and Farm Labor Housing Complex, with 173 housing units, lies just outside the District's boundaries and within its Sphere of Influence. Due to limited service capacity, it is not expected that any significant population growth will occur within the District boundaries in the near future. The Westley Community Services District struggles with aging infrastructure necessitating system-wide improvements (Stanislaus Local Agency Formation Commission, 2014).

***THIS PAGE INTENTIONALLY LEFT BLANK***

# **Appendix I-B1**

## **KNIGHTS FERRY HISTORICAL STANDARDS**

Adopted by the Stanislaus County Board of Supervisors

JUNE 23, 1987

***THIS PAGE INTENTIONALLY LEFT BLANK***



## APPENDIX I-B1

### KNIGHTS FERRY HISTORICAL STANDARDS

#### INTRODUCTION

Knights Ferry's colorful historic past, along with its unique physical setting, have combined to offer a community worthy of preservation. The primary objective of this section is to develop a base of information relating to the architectural and physical setting that will adequately describe the existing situation and to provide guidelines for new construction and rehabilitation which will assist the Planning Commission and Board of Supervisors when evaluating future construction in the Knights Ferry historical designation, thus preserving and enhancing the unique historic and physical setting. The ultimate goal of this plan is to assure that Knights Ferry's heritage will remain a functioning asset to the community through continued use and enjoyment.

The Historic Section is grouped into three categories:

#### Inventory of Building Details

Identifies the predominant architectural details found within the community.

#### Suggested Design Principles and Standards for New Construction

Intended to ensure the maximum compatibility of new construction with older buildings utilizing the Inventory of Building Details as a data base.

#### Suggested Guidelines for the Rehabilitation of Buildings

Specific actions to be considered or avoided to ensure the ongoing historic preservation.

#### Inventory of Building Details

While no single architectural style predominates in Knights Ferry, there does exist strong similarities of style, proportion, scale, material, and detail. These similarities form the basis of this inventory. This inventory will be helpful in understanding the architectural qualities of Knights Ferry and, in turn, will establish a good foundation for new planning and construction in the community.

The streetscapes of Knights Ferry display a variety of design and texture limited by several common "design elements". These elements are **height, proportion and scale, window and door openings, building placement, materials and details, entrances, continuity of street facades, color, and landscaping.**

#### Height:

The average height of the older residences and commercial buildings is 2 to 2 1/2 stories consisting of a groundfloor, one main story, and sometimes additional attic rooms.

### **Proportion and Scale:**

The heights of most buildings in Knights Ferry are generally at least one and one half times as great as their widths. The primary emphasis is consequently vertical. Scale, which is the relationship of the size of individual parts to one another and to man, is gauged by the building units (wood or stone), the window and door openings and their placement, and the architectural detailing. Most buildings in Knights Ferry have a consistent scale.

### **Window and Door Openings:**

Window and door openings are vertical, reflecting the overall proportions of the buildings.

### **Entrances:**

Door openings are placed at the ground floor level, reached by a short flight of stairs. Entrances are sheltered by a porch usually extending across the entire frontage of buildings.

### **Materials and Details:**

Horizontal wood siding is extensively used in the community. The majority of buildings have steep gable roofs covered by corrugated metal roofing material.

### **Building Placement (Spacing of Buildings):**

The streetscapes in Knights Ferry are composed of a rather random progression of building units. Large lots and vacant lots create voids in the streetscape.

### **Continuity of Street Facades:**

Buildings along Main Street are set back a uniform distance creating a close feeling. Buildings along side streets are setback at random distances. Stone retaining walls create narrow streets with no curbs, gutters or sidewalks.

### **Landscaping:**

Abundant natural vegetation and landscaping are integral parts of the Knights Ferry setting, enhancing existing buildings by creating a "grown in" feeling and acting as natural air conditioners. Most yards utilize a combination of fruit and shade trees, shrubs and fences for defining lots and private space.

### **Color:**

Most buildings tend toward low intensity shades of white and gray, weathered wood, and redwood stain. Stone work is left natural. Roof coverings are generally galvanized metal or composition roofing in grey shades.

When combined with the "design elements", building components such as window and door openings and specific details such as building materials and unique building features help to identify the character unique to Knights Ferry. The components and details include **building lot, exterior features of buildings, roofs, windows and doors, porches, ornamentation, benches, and street furniture and improvements.**

### **Building Lot:**

Most of the residential structures are constructed on relatively large lots sloping towards the river. However, very little cut and fill has taken place, relying entirely on low retaining walls constructed of sandstone, stone, river cobbles, or concrete for slope stability. Large trees, shrubs, and gardens are common due to the relatively large area of the lots.

**Exterior Features of Buildings:**

Exterior wall covering consists of horizontal wood siding which is either beveled or shiplap type giving a semi-rough texture to wood structures. Masonry buildings are constructed primarily of sandstone or river cobbles, giving them a rough texture. Exposed foundation walls are constructed of stone or concrete adding another textured surface to the exterior appearances.

**Roofs:**

Gables with relatively steep roofs predominate throughout the community. Vents are found in the apex of the gable. Although the original roofing materials were wood shingles, galvanized metal is the most commonly used roofing material today with some buildings utilizing gray composition roof tiles.

**Windows and Doors:**

Window and door openings tend to create a vertical dominance. Windows generally are 2 to 2 1/2 times as tall as they are wide extending nearly from floor to ceiling. Exterior framing around window openings is of light construction. Windows are wood frame double hung, having been added at a later date for unknown reasons.

In residential structures, the main entrance is a single door with some glazing in the top half. Wood screen doors are extensively used. Commercial and public buildings have double doors at the main entrance with glazing in the top half. Screen doors are not commonly used.

**Porches:**

Porches are an integral portion of the overall design of residential, commercial and public buildings. Porches normally extend across the front of the building. Support for porches is provided by 4 x 4 or 6 x 6 posts, sometimes having been given design by being turned on a lathe. The size of the supporting posts is indicative of the light frame construction utilized for almost all buildings. Flooring for the porches is wood.

**Ornamentation:**

Buildings tend to be of simple design with very little ornamentation. Most ornamentation is found on accessories such as door knobs and fences.

**Fences:**

In addition to having the most ornamentation of any structure, fences are an important building accessory in Knights Ferry. Both wood picket fences and cast-iron post and wire fences set upon stone retaining walls or curbing are prevalent in the community. Wood fences have posts with caps and pickets with a design cut into their top. Posts in cast-iron are capped by various knobs and foliate their top. Posts in cast-iron are capped by various knobs and foliate designs. The wire in these types of fences have a woven design with scalloped top wire. The fences are very light and at times delicate, enclosing the entire yard without obscuring the buildings behind them.

**Street Furniture and Improvements:**

All streets in the community, except Main Street, are narrow streets. Sidewalks, curbs, and gutters are not found in Knights Ferry. The combination of narrow streets and lack of curbs and gutters adds to the quaint character of the community which can be distinctively termed "Knights Ferry".

### **Suggested Design Principles and Standards for New Construction**

The use of these design principles and standards is not intended to require new buildings to be an exact duplication of older styles, but to ensure the maximum compatibility of new construction with other buildings in the Knights Ferry historical designation.



### **Height and Scale**

It is important that new buildings should be constructed to a reasonable average height of existing adjacent buildings within established historical districts.





### **Relationship of Materials**

A variety of materials, when properly used, can add to the distinctiveness of the area. Common materials are wood, stone, brick, stucco, or other materials. Used properly, materials can enhance desired qualities such as compatibility, continuity, similarity, harmony, etc.

### **Relationship to Textures**

The texture of a building is an important factor in the overall appearance of the town. The predominant texture is horizontal wood siding with rough (river cobbles), smooth (stucco), and other textures present. Whatever texture is used, its appearance must be considered in relationship to the area to ensure a compatible blending with other styles.

### **Relationship to Colors**

The proper application of a color scheme to a building or a series of buildings can highlight important features and increase their overall appearance. Accent or blending colors on building details is also desirable in enhancing the compatibility of structures.

### **Relationship of Architectural Details**

Similarity of architectural detail may be accomplished by the use of cornices, lintels, arches, wrought iron work, chimneys, etc. This similarity of detail is extremely important in ensuring a compatible appearance in new construction.



**Relationship of Roof**

The majority of buildings have gable or hip roofs. Roofs are an important factor in the overall design of a building to help relate items such as height and scale to those of adjacent structures.



**Rhythm of Spacing of Building on Street (Building Placement).**

Moving past a sequence of buildings, one experiences a rhythm of recurrent building masses to spaces between them. This rhythm is necessary to create an added element of harmony in the town's architecture.

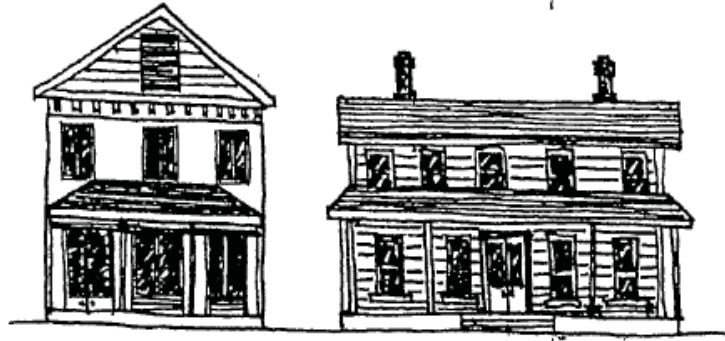

### **Directional Expression of Front Elevations (Window and Door Openings)**

Structural shape, placement of openings, and architectural details should give a predominantly vertical character to the building's facade. Although the front elevation of two adjacent buildings may be different in heights, mass, or both, their overall appearance can be compatible when a vertical direction is achieved by proper use of detail, color, materials, etc.



### **Continuity**

Physical ingredients such as wood fences, wrought iron fences, brick walls, evergreen landscape masses, building facades, or combinations of these form continuous, cohesive walls of enclosure along the street. This factor helps produce a cohesiveness in an area.

### **Relationship of Landscaping**

There is a predominance of a particular quality and quantity of landscaping. The concern here is more with mass and continuity. It is important that landscaping be placed to emphasize design rather than becoming an obscuring factor.

### **Suggested Guidelines for the Rehabilitation of Buildings and Structures**

Although stationary, structures are not static. It is necessary that they function today as they functioned a century ago and, indeed, should function a century hence. Change is inevitable. As structures age, they need maintenance and repair or alteration to accommodate new occupants and uses. This maintenance and change should be a compromise between yesterday and today to insure the architectural integrity of the structures and at the same time to enhance their utility. This category seeks both ends.

The following eight fundamental concepts can be considered basic guidelines for the rehabilitation of historic property. They are followed by a detailed checklist for the application of the guidelines to carry out actual rehabilitation projects. The checklist suggests specific actions to be considered or avoided to insure the ongoing preservation of historic property.

1. Every reasonable effort should be made to provide a compatible use for historic property which will require minimum alteration to the property and its environment.
2. Rehabilitation work should not destroy the historic character of the property and its environment. The removal or alteration of any historic material or architectural features should be held to the minimum consistent with the proposed use.
3. Deteriorated architectural features should be repaired rather than replaced, wherever possible. In the event replacement is necessary, the new material should match the material being replaced in composition, design, color, texture, and other visual qualities. Repair or replacement of missing architectural features should be based on accurate duplications of original features, substantiated by physical or pictorial evidence rather than on conjectural designs or the availability of architectural features from other properties.
4. Distinctive stylistic features or examples of skilled craftsmanship which characterize older structures and often predate the mass production of building materials, should be treated with sensitivity.
5. Changes to the property and its environment which have taken place in the course of time are evidence of the history of the property and the town. These changes may have developed significance in their own right, and this significance should be recognized and respected.
6. All historic property should be recognized as a product of its own time. Alterations to create an earlier appearance should be discouraged.
7. It is not the intent of these guidelines to discourage contemporary design of new buildings, additions to existing buildings, or landscaping in historic districts if such design is compatible with the size, scale, color, material, and character of the neighborhood, building, or its environment.
8. Wherever possible, additions or alterations to historic property should be done in such a manner that if they were to be removed in the future, the essential form and integrity of the original property would be unimpaired.



## CHECKLIST FOR THE APPLICATION OF BASIC GUIDELINES

These guidelines suggest specific actions which should be considered or avoided when remodeling or restoring existing structures.

### CONSIDER

#### Knights Ferry

Retaining distinctive features such as the size, scale, mass, color, and materials of buildings, including roofs, porches, and stairways that give the town its historic character.

Using new plant materials, fencing, walkways and street furniture which are compatible with the character of the town in size, scale, material, and color.

Retaining landscape features such as parks, gardens, street furniture, walkways, streets, and building setbacks which link historic properties to their environment.

Inspecting the site carefully to locate and identify plants, trees, fencing, walkways, and street furniture which might be an important part of the property's history and development.

Retaining plants, trees, fencing walkways, and street furniture which reflect the property's history and development.

Basing all decision for new work on actual knowledge of the past appearance of the property found in photographs, drawings, newspapers, and tax records. If changes are made, they should be carefully evaluated in light of the past appearance of the site.

### TRY TO AVOID

Introducing new construction or materials into the town which are incompatible with the character of the town because of size, scale, color and materials.

Introducing signs, street lighting, street furniture, new paint materials, fencing, walkways, and paving materials which are out of scale or inappropriate to the town.

Destroying the relationship of historic properties and their environment by widening existing streets, changing paving material, or by introducing poorly designed and poorly located new street and parking lots, or introducing new construction incompatible with the character of the town.

Making hasty changes to the appearance of the site by removing old plants, trees, fencing, walkways and street furniture before evaluating their importance in the property's history and development.

Over-restoring the site to an appearance it never had.

## Consider

Retaining the basic topography which reflects the character of the property.

Repairing and duplicating retaining walls wherever possible.

### Building: Exterior Features (Masonry Buildings)

Retaining original masonry, or stone and mortar, whenever possible, without the application of any surface treatment.

Duplicating old mortar in composition, color, and texture.

Duplicating old mortar in joint size, method of application, and joint profile.

Cleaning masonry, or only when necessary to halt deterioration and always with the gentlest method possible, such as low water pressure and soft, natural bristle brushes.

Repairing stucco with a stucco mixture duplicating the original as closely as possible in appearance and materials.

## TRY TO AVOID

### Building: Lot

Altering the topography by extensive grading and cut-and-fill operations that will destroy the character of the site except where necessary for safety and efficiency.

Constructing new retaining walls which are incompatible with earlier construction in the areas of materials, scale, and texture.

Applying waterproof or water repellent coatings or other treatments unless required to solve a specific technical problem that has been studied and identified. Coatings are frequently unnecessary, expensive, and can accelerate deterioration on the masonry or stone.

Repointing with mortar of high Portland cement content can create a bond that is often stronger than the building material. This can cause deterioration as a result of the differing coefficient of expansion and the differing porosity of the material and the mortar.

Repointing with mortar joints of a differing size or joint profile, texture, or color.

Sandblasting brick or stone surfaces; this method of cleaning erodes the surface of the material and accelerates deterioration.

Using chemical cleaning products which could have an adverse chemical reaction with the masonry or stone texture.

## CONSIDER

Repairing or replacing, where necessary, deteriorated material with new material that duplicates as closely as possible.

Replacing missing architectural features, such as cornices, brackets, railings, and shutters.

Retaining the original or early color and texture of masonry surfaces, wherever possible. Brick or stone surfaces may have been painted or whitewashed for practical and aesthetic reasons.

### (Frame Buildings)

Retaining original material whenever possible.

Repairing or replacing, where necessary, deteriorated material with new material that duplicates the old as closely as possible.

### (Roofs)

Preserving the original roof shape.

## TRY TO AVOID

Applying new material which is inappropriate or was unavailable when the building was constructed, such as the old artificial brick siding, artificial cast stone or brick veneer.

Removing architectural features such as cornices, brackets, railings, shutters, window architraves and doorway pediments. These are usually an essential part of a building's character and appearance, illustrating the continuity of growth and change.

Indiscriminate removal of paint from masonry surfaces. This may be historically incorrect and may also subject the building to harmful damage.

Removing architectural features such as siding, cornices, brackets, railings, shutters, window architraves and doorway pediments. These are, in most cases, an essential part of a building's character and appearance illustrating the continuity of growth and change.

Resurfacing frame buildings with new material which is inappropriate or was unavailable when the building was constructed such as artificial stone, brick veneer, asbestos or asphalt shingles, plastic or aluminum siding. Such material also can contribute to the deterioration of the structure from moisture and insect attacks.

Changing the original roof shape or adding features inappropriate to the essential character of the roof such as oversized dormer windows or picture windows.

## CONSIDER

Retaining the original roofing material whenever possible.

Replacing deteriorated roof coverings with new material that matches the old in composition, size, shape, color, and texture.

Preserving or replacing, where necessary, all architectural features which give the roof its essential character, such as dormer windows, cupolas, cornices, brackets, chimneys, and cresting.

Placing television antennae and mechanical equipment, such as air conditioners, in an inconspicuous location.

(Windows and Doors)

Retaining existing window and door openings including window sash, glass lintels, sills, architraves, shutters and doors, pediments, tools, and all hardware.

The stylistic period or periods a building represents. If replacement of window sash or doors is necessary, the replacement should duplicate the material, design, and the hardware of the older window sash or door.

## TRY TO AVOID

Applying new roofing material that is inappropriate to the style of the building and the town.

Replacing deteriorated roof coverings with new materials which differ to such an extent from the old in composition, size, shape, color, and texture that the historical integrity of the property is diminished.

Stripping the roof of architectural features important to its character.

Introducing new window and door openings into the principal elevations of historic buildings, or enlarging or reducing window or door steps, openings to fit new stock window sash or new stock door sizes.

Altering the size of window panes or sash which is part of the structure's historic fabric. Such changes destroy the scale and proportion of the building.

Discarding original doors and door hardware when they can be repaired and reused in place.

Inappropriate new window or door features such as aluminum storm and screen window combinations that require the removal of original windows and doors or the installation of plastic or metal strip awnings or false shutters that disturb the character and appearance of the building.

## CONSIDER

## TRY TO AVOID

### Building: Exterior Features (cont.)

#### (Porches and Steps)

Retaining porches and steps which are appropriate to the building and its development. Porches or additions reflecting later architectural styles are often important to the building's historical integrity and, whenever possible, should be retained.

Repairing or replacing, where necessary, deteriorated architectural features of wood, iron, cast iron, terra-cotta, tile, and brick.

Repairing or replacing, where necessary, deteriorated material with new material that duplicates as closely as possible.

### Building: Interior Features

Retaining original material, architectural features and hardware, whenever possible, such as stairs, handrails, baluster, mantelpieces, cornices, chair rail, baseboard, panelings, doors and doorways, wallpaper, lighting fixtures, locks, and door knobs.

Removing or altering porches and steps which are appropriate to the building and its development and the style or styles it represents.

Stripping porches and steps of original material and architectural features, such as hand rails, balusters, columns, brackets, and roof decoration of wood, iron, cast iron, terra-cotta, tile, and brick.

Applying new material which is inappropriate or was unavailable when the building was constructed, such as the old artificial cast stone, brick veneer, asbestos or asphalt shingles, or plastic or aluminum siding.

Enclosing porches and steps in a manner that destroys their intended appearance.

Removing original material, architectural features and hardware, except where essential for safety or efficiency.

## CONSIDER

## TRY TO AVOID

### Building: Interior Features (cont.)

Repairing or replacing, where necessary, deteriorated material with new material that duplicates the old as closely as possible.

Retaining original plaster, whenever possible.

Discovering and retaining original paint colors, wallpapers and other decorative motifs or, where necessary, replacing them with colors, wallpapers or decorative motifs based on the original.

### Color

Discovering and retaining original paint colors, or repainting with colors based on the original to illustrate distinctive character of the property.

### Plan and Function

Using a building for its intended purpose.

Finding an adaptive use, when necessary, which is compatible with the plan, structure, and appearance of the building.

Retaining the basic plan of a building, whenever possible.

Installing new decorative material which is inappropriate or was unavailable when the building was constructed, such as vinyl, plastic or imitation wood wall and floor coverings, except in utility areas such as kitchens and bathrooms.

Destroying original plaster except where necessary for safety and efficiency.

Repainting with colors that cannot be documented through research and investigation to be appropriate to the building and neighborhood.

Altering a building to accommodate an incompatible use requiring extensive alterations to the plan, materials and appearance of the building.

Altering the basic plan of a building by demolishing principal walls, partitions, and stairways.

## CONSIDER

## TRY TO AVOID

### New Additions

Keeping additions to historic buildings to a minimum and making them compatible in scale, building materials, and texture.

Designing additions to be compatible in materials, size, scale, color, and texture with the earlier building and the area.

Using contemporary designs compatible with the character and mood of the building or area.

Making unnecessary additions to historic property.

Designing additions which are incompatible with the earlier building and the area in materials, size, scale, and texture.

Imitating an earlier style or period of architecture in additions, except in rare cases where a contemporary design would detract from the architectural unity of an ensemble or group. Especially avoid imitating an earlier style of architecture in additions that have a completely contemporary function such as a gas station.

Causing unnecessary damage to the plan, materials, and appearance of the building when installing mechanical plan services.

### Mechanical Services: Heating, Electrical, and Plumbing

Installing necessary building services in areas and spaces that will require the least possible alteration to the materials, and appearance of the building.

Installing the vertical runs of ducts, pipes, and cables in closets, service rooms, and wall cavities.

Selecting mechanical systems that best suit the building.

Rewiring early lighting fixtures.

Installing vertical runs of ducts, pipes, and cables in places where they will be a visual intrusion.

Cutting holes in important architectural features, such as cornices, decorative ceilings and paneling.

Installing "dropped" acoustical ceilings to hide inappropriate mechanical systems. This destroys the proportions and character of the rooms.

CONSIDER

TRY TO AVOID

Mechanical Services: Heating, Electrical, and Plumbing (cont.)

Having exterior electrical and telephone cables installed underground.

Having exterior electrical and telephone cables attached to the principal elevations of the building.

Safety and Code Requirements

Complying with code requirements in such a manner that the essential character of a property is preserved intact.

Investigating variances for historic properties afforded under some local codes.

Installing adequate fire prevention equipment in a manner which does minimal damage to the appearance or historic fabric of a property.



## FOR FURTHER REFERENCE

The following books, magazines, and organizations will provide sound, basic information about the rehabilitation and care of historic property.

### Books

Bullock, Orin M., Jr., The Restoration Manual: An Illustrated Guide to Preservation and Restoration of Old Buildings, Norwalk, Connecticut: Silvermine Publishers, Inc., 1966.

Cantacuzino, Sherban, New Uses for Old Buildings, London: Architectural Press, 1975.

Criswell, John F., Knights Ferry's Golden Past, United States Of America, August, 1974.

Historic Walker's Point, Inc., Preservation Minded Home Improvements: The Exterior, Milwaukee, Wisconsin.

Insall, Donald W., The Care of Old Buildings Today: A Practical Guide, London: Architectural Press, 1972.

Stephen, George, Remodeling Old Houses Without Destroying Their Character, New York: Alfred A. Knoff.

### Magazine

The Old-House Journal, a monthly publication, published by the Old-House Journal Corporation, 199 Berkeley Place, Brooklyn, N.Y. 11217.

### Organizations

Committee on Historic Resources; American Institute of Architects;  
1735 New York Avenue, Northwest, Washington, D.C. 20006

E Clampus Vitus, Estanislao Chapter, Jack Brotherton, Historian

***THIS PAGE INTENTIONALLY LEFT BLANK***

## **Appendix I-B2**

# **LA GRANGE HISTORICAL STANDARDS**

Adopted by the Stanislaus County Board of Supervisors

JUNE 23, 1987

***THIS PAGE INTENTIONALLY LEFT BLANK***

## LA GRANGE HISTORICAL STANDARDS

### APPENDIX I-B2

#### HISTORY

La Grange's colorful historic past created many buildings and structures worthy of preservation. Unfortunately, many of these structures have since been destroyed by flood or inactivity. The few remaining structures are scattered throughout the town amidst newer structures. The primary objective of this section is to identify the structures (see Historical Site Map on Page 1-36) and develop guidelines for the preservation of their character and setting.

This section will provide guidelines that will assist the Planning Commission and Board of Supervisors when evaluating future construction and reconstruction in the La Grange historical designation, thus preserving and enhancing the unique historic character and setting. The ultimate goal of this plan is to assure that La Grange's heritage will remain a functioning asset to the community through continued use and enjoyment.

In order that the historical character and setting of the community is preserved, the Historical section is grouped into three categories:

1. Inventory of Building Details  
Identifies the predominant architectural details found within the community.
2. Suggested Design Principles and Standards for New Construction  
Intended to ensure the maximum compatibility of new construction with older buildings utilizing the Inventory of Building Details as a data base.
3. Suggested Guidelines for the Rehabilitation of Buildings  
Specific actions to be considered or avoided to ensure the ongoing historic preservation.

# HISTORICAL SITES

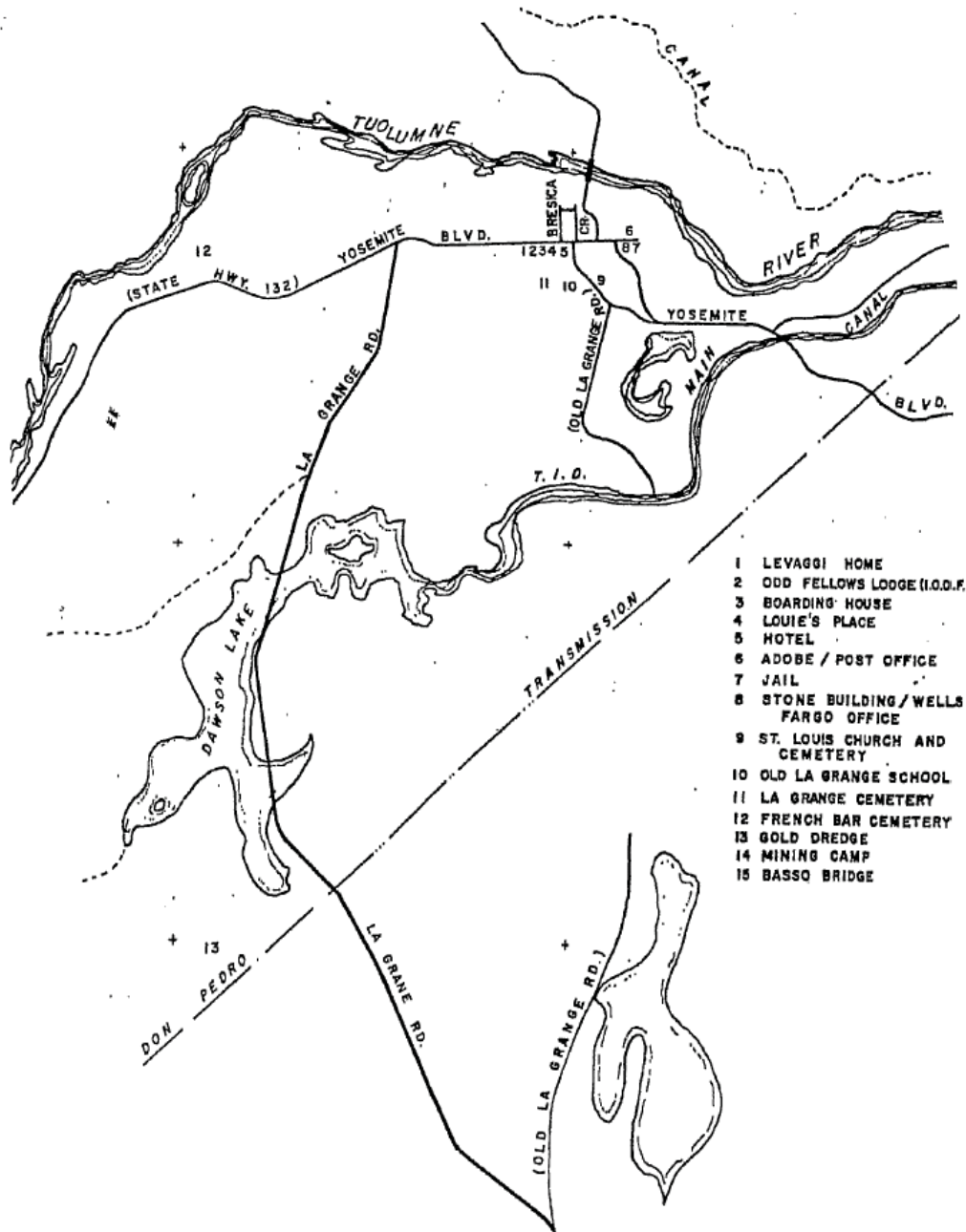

- 1 LEVAGGI HOME
- 2 ODD FELLOWS LODGE (I.O.O.F.)
- 3 BOARDING HOUSE
- 4 LOUIE'S PLACE
- 5 HOTEL
- 6 ADOBE / POST OFFICE
- 7 JAIL
- 8 STONE BUILDING / WELLS FARGO OFFICE
- 9 ST. LOUIS CHURCH AND CEMETERY
- 10 OLD LA GRANGE SCHOOL
- 11 LA GRANGE CEMETERY
- 12 FRENCH BAR CEMETERY
- 13 GOLD DREDGE
- 14 MINING CAMP
- 15 BASSO BRIDGE

## Inventory of Building Details

With many original buildings missing and their void being filled in by newer structures constructed over a long time span, no definitive architectural style or styles dominate. Even though there is no dominant architectural style, some similarities in building height, color, and landscaping exist. These similarities form the basis of this inventory. This inventory will establish a good foundation for planning and for evaluating proposed construction in the community.

**Height:** The average height of the older residences is 1 to 1 ½ stories consisting of a ground floor and sometimes additional attic rooms. Commercial buildings are either one or two stories in height.

**Entrances:** Door openings are placed at the ground floor level, reached by a short flight of stairs. Entrances are sheltered by a porch, at times extending across the entire frontage of buildings.

**Color:** Most buildings tend toward low intensity shades of white and gray, weathered wood, and redwood stain. Stone work is left natural. Roof coverings are generally wood shingles or composition roofing in grey shades.

**Landscaping:** Natural vegetation is an integral part of the La Grange setting. Yards are small with most of the landscaping to be found in front of the homes. Most yards utilize a combination of fruit and shade trees, shrubs, and fences for defining lots and private space.

**Roofs:** Most structures have either gable or hip roofs. Roofing materials are wood singles or grey composition shingles.

## Suggested Design Principles and Standards for New Construction

The use of these design principles and standards is not intended to require new buildings to be an exact duplication of older styles, but to ensure the maximum compatibility of new construction with other buildings in the La Grange historical designation.

1. Height and Scale. It is important that new buildings should be constructed to a reasonable average height of existing adjacent buildings within established historical districts.
2. Relationship to Colors. The proper application of a color scheme to a building or a series of buildings can highlight important features and increase their overall appearance. Accenting or blending colors on building details is also desirable in enhancing the compatibility of structures.
3. Relationship of Landscaping. There is a predominance of a particular quality and quantity of landscaping. The concern here is more with mass and continuity. It is important that landscaping be placed to emphasize design rather than becoming an obscuring factor.

4. Continuity. Physical ingredients such as wood fences, wrought iron fences, brick walls, evergreen landscape masses, building facades, or combinations of these form continuous, cohesive walls of enclosure along the street.
5. Relationship of Roof. The majority of buildings have gable or hip roofs. Roofs are an important factor in the overall design of a building to help relate items such as height and scale to those of adjacent structures.

#### Suggested Guidelines for the Rehabilitation of Buildings and Structures

Due to the fact that many of the historic buildings have deteriorated or been destroyed, the emphasis of the Community Plan is placed on the preservation and rehabilitation of remaining buildings. Although stationary, structures are not static. It is necessary that they function today as they functioned a century ago and, indeed, should function a century hence. Change is inevitable. As structures age, they need maintenance and repair or alteration to accommodate new occupants and uses. This maintenance and change should be a compromise between yesterday and today at once to insure the architectural integrity of the structures and, at the same time, to enhance their utility.

The following eight fundamental concepts can be considered basic guidelines for the rehabilitation of historic property. They are followed by a detailed checklist for the application of the guidelines to carry out actual rehabilitation projects. The checklist suggests specific actions to be considered or avoided to insure the ongoing preservation of historic property.

1. Every reasonable effort should be made to provide a compatible use for historic property which will require minimum alteration to the property and its environment.
2. Rehabilitation work should not destroy the historic character of the property and its environment. The removal or alteration of any historic material or architectural features should be held to the minimum consistent with the proposed use.
3. Deteriorated architectural features should be repaired rather than replaced wherever possible. In the event replacement is necessary, the new material should match the material being replaced in composition, design, color, texture, and other visual qualities. Repair or replacement of missing architectural features should be based on accurate duplications of original features, substantiated by physical or pictorial evidence rather than on conjectural designs, or the availability of architectural features from other properties.
4. Distinctive stylistic features or examples of skilled craftsmanship which characterize older structures and often predate the mass production of building materials should be treated with sensitivity.
5. Changes to the property and its environment which have taken place in the course of time are evidence of the history of the property and the town. These changes may have developed significance in their own right, and this significance should be recognized and respected.



6. All historic property should be recognized as a product of its own time. Alterations that restore a building to an earlier appearance which the building never had, should be discouraged.
7. It is not the intent of these guidelines to discourage contemporary design of new buildings, additions to existing buildings, or landscaping in historic districts if such design is compatible with the size, scale, color, material, and character of the neighborhood, building, or its environment.
8. Wherever possible, new additions or alterations to historic property should be done in such a manner that if they were to be removed in the future, the essential form and integrity of the original property would be unimpaired.

### **CHECKLIST FOR THE APPLICATION OF BASIC GUIDELINES**

These guidelines suggest specifications which should be considered or avoided when remodeling or restoring existing structures.

#### CONSIDER

#### TRY TO AVOID

#### La Grange

Retaining distinctive features such as the size, scale, mass, color, and materials or buildings, including roofs, porches, stairways that give the town its historic character.

Introducing new construction or materials into the town which are incompatible with the character of the town and because of size, scale, color, and materials.

Using new plant materials, fencing, walkways, and street furniture which are compatible with the character of the town in size, scale, material, and color.

Introducing signs, street lighting, street furniture, new plant materials, fencing, walkways, and paving materials which are out of scale or inappropriate to the town.

Retaining landscape features such as gardens, street furniture, walkways, streets, and building setbacks which link historic properties to their environment.

Destroying the relationship of historic properties and their environment by widening existing streets, changing paving material, or by introducing poorly designed and poorly located new streets and parking lots, or introducing new construction incompatible with the character of the town.

#### Building: Lot

Inspecting the site carefully to locate and identify plants, trees, fencing, walkways, and street furniture which might be an important part of the property's history and development.

## CONSIDER

Retaining plants, trees, fencing, walkways, and street furniture which reflect the property's history and development.

Basing all decisions for new work on actual knowledge of the past appearance of the property found in photographs, drawings, newspapers, and tax records. If changes are made, they should be carefully evaluated in light of the past appearance of the site.

Retaining the basic topography which reflects the character of the property.

### Building: Exterior Features

#### (Masonry Buildings)

Retaining original masonry, or stone and mortar, whenever possible, without the application of any surface treatment.

Duplicating old mortar in composition, color, and texture.

Duplicating old mortar in joint size, method of application, and joint profile.

## TRY TO AVOID

Making hasty changes to the appearance of the site by removing old plants, trees, fencing, walkways, and street furniture before evaluating their importance in the property's history and development.

Over-restoring the site to an appearance it never had.

Altering the topography by extensive grading and cut and fill operations that will destroy the character of the site except where necessary for safety and efficiency.

Applying waterproof or water repellent coatings or other treatments unless required to solve a specific technical problem that has been studied and identified. Coatings are frequently unnecessary, expensive, and can accelerate deterioration of the masonry or stone.

Repointing with mortar of high Portland cement content can create a bond that is often stronger than the material. This can cause deterioration as a result of the differing coefficient of expansion and the differing porosity of the material and the mortar.

Repointing with mortar joints of a differing size or joint profile, texture, or color.

## CONSIDER

Cleaning masonry, or only when necessary, to halt deterioration always with the gentlest method possible, such as low pressure water and soft, natural bristle brushes.

Repairing stucco with a stucco mixture duplicating the original as closely as possible in appearance and texture.

Repairing or replacing, where necessary, deteriorated material with new material that duplicates the old as closely as possible.

Replacing missing architectural features, such as cornices, brackets, railings, and shutters.

Retaining the original or early color and texture of masonry surfaces, wherever possible. Brick or stone surfaces may have been painted or whitewashed for practical and aesthetic reasons.

(Frame Buildings)

Retaining original material, whenever possible.

## TRY TO AVOID

Sandblasting brick or stone surfaces; this method of sand cleaning erodes the surface of the material and accelerates deterioration.

Using chemical cleaning products which could have an adverse chemical reaction with the masonry or stone materials.

Applying new material which is inappropriate or was unavailable when the building was constructed, such as artificial brick siding, artificial cast stone or brick veneer.

Removing architectural features, such as cornices, brackets, railings, shutters, window architraves, and doorway pediments. These are usually an essential part of a building's character and appearance, illustrating the continuity of growth and change.

Indiscriminate removal of paint from masonry surfaces. This may be historically incorrect and may also subject the building to harmful damage.

Removing architectural features such as siding, cornices, brackets, railings, shutters, window architraves, and doorway pediments. These are, in most cases, an essential part of a building's character and appearance, illustrating the continuity of growth and change.

## CONSIDER

Repairing or replacing, where necessary, deteriorated material with new material that duplicates the old as closely as possible.

### (Roofs)

Preserving the original roof shape.

Retaining the original roofing material, whenever possible.

Replacing deteriorated roof coverings with new material that matches the old in composition, size shape, color, and texture.

Preserving or replacing, where necessary, all architectural features which give the roof its essential character, such as dormer windows, cupolas, cornices, brackets, chimneys, and cresting.

Placing television antennae and mechanical equipment, such as air conditioners, in an inconspicuous location.

## TRY TO AVOID

Resurfacing frame buildings with new material which is inappropriate or was unavailable when the building was constructed such as artificial stone, brick veneer, asbestos or asphalt shingles, plastic or aluminum siding. Such material also can contribute to the deterioration of the structure from moisture and insect attacks.

Changing the original roof shape or adding features inappropriate to the essential character of the roof such as oversized dormer windows or picture windows.

Applying new roofing material that is inappropriate to the style of the building and the town.

Replacing deteriorated roof coverings with new materials which differ to such an extent from the old in composition, size, shape, color, and texture that the historical integrity of the property is diminished.

Stripping the roof of architectural features important to its character.

## CONSIDER

## TRY TO AVOID

### Building: Exterior Features (cont).

#### (Windows and Doors)

Retaining existing window and door openings including sash, glass lintels, architraves, shutters and doors, pediments, hoods, steps, and all hardware.

The stylistic period or periods a building represents. If replacement of window sash or doors is necessary, the replacement should duplicate the material, design, and the hardware of the older window sash or door.

Introducing new window and door openings into the window principal elevations of historic buildings, or enlarging or reducing window or door steps, openings to fit new stock window sash or new stock door sizes.

Altering the size of window panes or sashes which are part of the structure's historic fabric. Such changes destroy the scale and proportion of the building.

Discarding original doors and door hardware when they can be repaired and reused in place.

Inappropriate new window or door features such as aluminum storm and screen window combinations that require the removal of original windows and doors, or the installation of plastic or metal strip awnings or fake shutters that disturb the character and appearance of the building.

#### (Porches and Steps)

Retaining porches and steps which are appropriate to the building and its development. Porches or additions reflecting later architectural styles are often important to the building's historical integrity and, whenever possible, should be retained.

Removing or altering porches and steps which are appropriate to the building and its development represents.

Building: Exterior Features(cont.)

CONSIDER

Repairing or replacing, where necessary, deteriorated architectural features of wood, iron, cast iron, terra-cotta, and brick.

Repairing or replacing, where necessary, deteriorated material with new material that duplicates the old as closely as possible.

TRY TO AVOID

Stripping porches and steps of original material and architectural features, such as hand rails, balusters, tile, columns, brackets, and roof decoration of wood, iron, cast iron, terra-cotta, tile, and brick.

Applying new material which is inappropriate or was unavailable when the building was constructed, such as artificial cast stone, brick veneer, asbestos or asphalt shingles, or plastic or aluminum siding.

Enclosing porches and steps in a manner that destroys their intended appearance.

## CONSIDER

## TRY TO AVOID

### Building: Interior Features

Retaining original material, architectural features, and hardware whenever possible, such as stairs, handrails, baluster, mantelpieces, cornices, chair rail, baseboard, panelings, doors and doorways, wallpaper, lighting fixtures, locks and doorknobs.

Repairing or replacing where necessary, deteriorated material with new material that duplicates the old as closely as possible.

Retaining original plaster whenever possible.

Discovering and retaining original paint colors, wallpapers and other decorative motifs or where necessary, replacing them with colors, wallpapers or decorative motifs based on the original.

### Color

Discovering and retaining original paint colors, or repainting with colors based on the original to illustrate the distinctive character of the property.

### Plans and Function

Using a building for its intended purpose.

Finding an adaptive use, when necessary, which is compatible with the plan, structure, and appearance of the building.

Removing original material, architectural features and hardware, except where essential for safety or efficiency.

Installing new decorative material which is inappropriate or was unavailable when the building was constructed, such as vinyl, plastic, or imitation wood wall and floor coverings, except in utility areas such as kitchens and bathrooms.

Destroying original plaster except where necessary for safety and efficiency.

Repainting with colors that cannot be documented through research and investigation to be appropriate to the building and the neighborhood.

Altering a building to accommodate an incompatible use requiring extensive alterations to the plan, materials, and the appearance of the building.

## CONSIDER

## TRY TO AVOID

### Building: Interior Features (cont.)

Retaining the basic plan of a building whenever possible.

Altering the basic plan of a building by demolishing principal walls, partitions and stairways.

### Additions

Keeping additions to historic buildings at a minimum and pursuing the use of similar scale, building materials, and texture.

Unnecessary additions to historic property.

Designing additions to be compatible in materials, size, scale, color, and texture with the earlier building and the area.

Additions which are incompatible with the earlier building and the area in materials, size, scale, and texture.

Using contemporary designs compatible with the character and mood of the building or the area.

Imitating an earlier style or period of architecture in additions, except in rare cases where a contemporary design would detract from the architectural unity of an ensemble or group. Especially avoid imitating an earlier style of architecture in additions that have a completely contemporary function such as a gas station.

### Mechanical Services: Heating, Electrical, and Plumbing

Installing necessary building services in areas and space that will require the least possible alteration to the plan, materials, and appearance of the building.

Causing unnecessary damage to the plan, materials, and appearance of the building when installing mechanical services.

Installing the vertical runs of ducts, pipes, and cables in closets, service rooms, and wall cavities.

Installing vertical runs of ducts, pipes, and cables in places where they will be a visual intrusion.

Cutting holes in important architectural features, such as cornices, decorative ceilings, and paneling.



## CONSIDER

### Mechanical Services: Heating, Electrical, and Plumbing (cont.)

Selecting mechanical systems that best suit the building.

Rewiring early lighting fixtures.

Having exterior electrical and telephone cables installed underground.

### Safety and Code Requirements

Comply with code requirements in such a manner that the essential character of a property is preserved intact.

Investigating variances for historic properties afforded under some local codes.

Installing adequate fire prevention equipment in a manner which does minimal damage to the appearance or historic fabric of a property.

Providing access for the handicapped without damaging the essential character of a property.

## TRY TO AVOID

Installing “dropped” acoustical ceilings to hid inappropriate mechanical systems. This destroys the proportions and character of the rooms.

Having exterior electrical and telephone cables attached to the principal elevations of the building.

## FOR FURTHER REFERENCE

The following books, magazines, and organizations will provide sound, basic information about the rehabilitation and care of historic property.

### Books

Bullock, Orin M., Jr., The Restoration Manual: An Illustrated Guide to Preservation and Restoration of Old Buildings, Norwalk, Connecticut: Silvermine Publishers, Inc., 1966.

Cantacuzino, Sherban, New Uses for Old Buildings, London: Architectural Press, 1975.

Gray, Thorne B., Quest for Deep Gold: The Story of La Grange, California, La Grange, California, 1973,

Historic Walker's Point, Inc., Preservation Minded Home Improvements: The Exterior, Milwaukee, Wisconsin.

Insall, Donald W., The Care of Old Buildings Today: A Practical Guide, London: Architectural Press, 1972.

Stephen, George, Remodeling Old Houses Without Destroying Their Character, New York: Alfred A. Knoff.

### Magazine

The Old-House Journal, a monthly publication, published by the Old-House Journal Corporation, 199 Berkeley Place, Brooklyn, N.Y. 11217

### Organizations

Committee on Historic Resources; American Institute of Architects; 1735 New York Avenue, Northwest; Washington, D.C. 20006

E Clampus Vitus, Estanislao Chapter; Jack Brotherton, Historian

Interagency Historic Architectural Services Program; Office of Archeology and Historic Preservation; National Park Service; Department of the Interior; Washington, D.C. 20240

Office of Preservation Services; National Trust for Historic Preservation; 740-748 Jackson Place, Northwest; Washington, D.C. 20006

Stanislaus County Historical Society; c/o Jack Brotherton; 1226 Fiori Avenue; Modesto, California 95350

# **Appendix I-B3**

## **SALIDA DESIGN GUIDELINES**

Adopted by the Stanislaus County Board of Supervisors

DECEMBER 17, 1991

***THIS PAGE INTENTIONALLY LEFT BLANK***

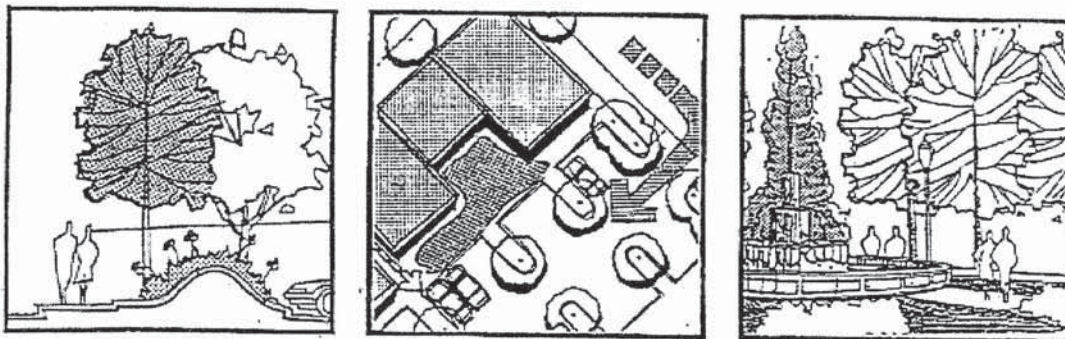

# DESIGN GUIDELINES

***THIS PAGE INTENTIONALLY LEFT BLANK***

**INTRODUCTION**

The Salida Design Guidelines will provide a flexible framework to guide both public and private community revitalization efforts in the form of physical and aesthetic improvements within the Salida Redevelopment Area. Improvements in the streetscape, creation of a consistent architectural theme, and preservation of the agricultural/western "small town" character represent desirable outcomes.

The following Community Design Guidelines are based on the citizen input gathered from Municipal Advisory Committee (MAC) meetings, the "Have a Say in Salida's Future" questionnaire and a photo survey. The surveys and meetings allowed local citizens to identify positive and negative elements of Salida.

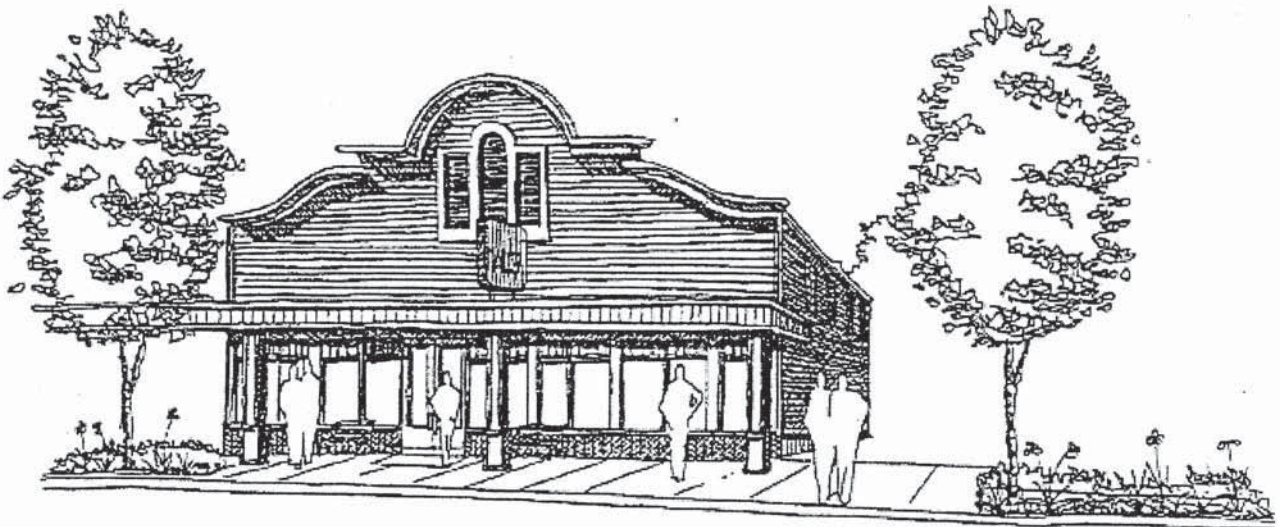

Citizen Participation

Public design guidelines are a control device that affect community image, identity, and economic trends. Therefore, it is crucial that criteria for design controls be based on a consensus of citizen opinion.

Ensuring equitable representation of citizen's views is difficult considering the diversity of tastes, culture, and lifestyles resulting from changing population patterns in rural and small town communities. Long-term residents and new residents may have different ideas about what constitutes rural or small town, as well as desirable or undesirable urban design.

For Salida, these issues guided the survey methods used to retrieve citizen opinion, community character, and design image. A description of the methods used to gain public input for the development of Salida's Community Design Guidelines Manual follows:

1. Public Meetings

Meeting with the Salida's Municipal Advisory Community (MAC) provided the opportunity to share with the community the process involved with community redevelopment. They have also been valuable for the information supplied by the community. They provided insight into survey development and potential survey problems. The MAC has provided an essential link to the community in gaining one-on-one contact and information exchange with the citizens of Salida.

The following is a list generated as a result of an "icons" and "aliens" discussion conducted at the first MAC meeting. Icons being elements of the town that are admirable or desirable and aliens being those that are undesirable or alien.

Icons

Smallness (image of)  
Main Street  
Existing Median Trees  
Agriculture  
Sense of Community  
Park -- but need to redesign  
Old Grocery Store  
Uniform Signage Ordinance  
Building Height Limitations  
Bicycle Paths

Aliens

Poor Drainage  
Poor Lighting  
Lack of Curbs and Sidewalks  
Walled Communities  
Lack of Public Restrooms  
Old Salida Boulevard (99)  
splits community  
Extra Streets --Lack of direction  
of some streets  
Mix of Architectural Styles  
Lack of Services  
Railroad Splits Community



**2. "Have a Say" Survey**

The survey was a one-page questionnaire that was made available to the public in Salida's markets, post office, bank, and library (Appendix, page 1-111). They were located in places that are frequented by a wide cross-section of Salida residents. The survey provided the design guidelines design team with the necessary information to prioritize a large range of issues affecting Salida.

A total of 123 surveys were completed, and they revealed some general trends in the public's concern over Salida's future. The primary concern involved the poor condition of streets, the lack of adequate sidewalks, and street lighting. Concern about the condition of the downtown and the parks emerged, as well as concerns about police protection. The following list summarizes the key issues raised in the survey:

- \* Insufficient Street (curb, gutter, and sidewalk) Improvements
- \* Lack of Street Lighting
- \* Safety in Parks
- \* Downtown Improvements
- \* Retaining "Small Town" Character
- \* Lack of Landscaping
- \* General Cleanup of Community
- \* Inadequate Police Protection

**3. Photo Survey**

The photo survey was an exercise to better understand the positive and negative community images as seen by the residents of Salida. There were 12 cameras; six were labeled "Do Like", and six were labeled "Don't Like". The MAC chose members of the community to take pictures of things and places that they liked and didn't like depending on the camera they were issued.

The result was a greater effort by the camera users to show the things and places that they didn't like (all six "Don't Like" cameras and two "Do Like" cameras were returned). To a lesser degree, the camera users took pictures of things and places they did like. The "Do Like" pictures reflect things and places located in Salida as well as other communities.

In addition to the photos, the camera users were asked to provide written comments regarding the photos taken and other concerns they wished to express. As a result, the photo survey exercise identified the following as being problem areas within the Community of Salida:

- A. Street Improvements - Sidewalks, curbs, street lighting, and circulation problems.
- B. Commercial Buildings - Lack of cohesive architectural style and character.

- C. Commercial Development - Downtown commercial core identify. Need to develop infill lots.
- D. The Median - Lack of drainage currently causing puddling in median. Needs curbs and landscaping to prevent parking within median area.
- E. People Spaces and Parks - Lack of sidewalks and streetscape makes walking in and around downtown difficult.
- F. Residential Areas - Lack of curbs, gutters, and sidewalks, unpaved streets and alleys. Trash and junk in residential yards and vacant lots.

The positive or desirable elements within the community reflected through the photo survey were:

- A. Newer development in both the downtown and industrial areas. Examples are Carl's Jr. Restaurant, Bueno Deli, and most schools and churches in the community.
- B. Buildings on Broadway, such as the Broadway Market, Union Safe Bank, Salida Home Market, and the United Congregational Church.
- C. Mature landscape and trees such as those in the Broadway median and park.

**Conclusion**

In conclusion, the results of each of the community involvement techniques (MAC meetings, "Have a Say" questionnaire and photo survey) were successful in establishing an understanding of the problems and opportunities within the community which served to direct the preparation of the guidelines.

**DESIGN GUIDELINES**

The following Design Guidelines are broken up into five areas of concern or sections. The sections were established in response to initial community analysis and survey results. The first three sections represent area specific districts within Salida's redevelopment area. The guidelines in these sections are divided into physical design categories such as site planning, architecture, and street improvements and are tangibly specific. The last two sections are area-wide guidelines requiring general application. These sections are policy oriented, requiring subsequent efforts to establish implementation mechanisms. (Map on page 1-58)

**Section I      **Downtown Commercial District****

Section I focuses on the downtown commercial district. The downtown commercial district represents the Broadway Street corridor west of Highway 99. Because of overwhelming community concern over Salida's lack of a centralized downtown identity and architectural theme, the downtown was singled out as an important area warranting the need to have its own design treatment. (Page 1-59)

**Section II      **Nonresidential District****

Section II of the guidelines addresses the nonresidential district. The nonresidential district represents all commercial, office, industrial, and public facility land uses that exist within the redevelopment area, but are outside the residential district and the downtown commercial district. The design guidelines are flexible enough to apply to all land uses within this district. (Page 1-83)

**Section III      **Residential****

Section III is the residential district of Salida. The residential district represents all residential areas inside the redevelopment area. The guidelines apply primarily to the "older" existing neighborhoods, since the Salida residents expressed concerns about the condition of these neighborhoods. These are also the neighborhoods that will probably experience rehabilitation and renovation efforts first and will benefit more directly from redevelopment. Primary concerns centered around the existing housing stock, the accumulation of trash, junk, and abandoned cars, and unpaved alleys, streets, and lack of curbs.

Within the established residential neighborhoods of Salida, there are district areas representing different eras in the architecture, siting, and public improvements of the homes. These guidelines are intended to respect that and encourage the preservation of the historical nature of each district area.

The primary concern toward the "newer" neighborhoods is how they are interfacing with the existing neighborhoods. In particular, concern was expressed over the new "walled communities" that are springing up on the edges of Salida. While not denying that there are some positive attributes created by enclosing a subdivision within walls, the negative effects of walled neighborhoods is being felt by the surrounding community. Walled subdivisions represent a poor solution to suburban design and land use concerns and have resulted in the disruption and fragmentation of the uniformity in the natural outgrowth of older residential neighborhoods. Guidelines in Section III addresses this and other identified concerns. (Page 1-93)

**Section IV   Parks**

Section IV speaks specifically to concerns raised regarding parks and public use areas within Salida. The focus is on the major park in Salida located on Broadway. Park guidelines outline an overall Park Plan for the community. The plan conceptually suggests ways to increase safety, pedestrian links, and aesthetics for a comprehensive park system. (Page 1-104)

**Section V   General Cleanup**

Section V is aimed at directing and encouraging community cleanup efforts. It is intentionally general in nature. This section was developed because of the overwhelming public response toward the enormous amounts of trash and abandoned cars that have accumulated throughout the community. The guidelines suggest ways to prevent this buildup of abandoned cars and trash. (Page 1-106)

SALIDA DESIGN GUIDELINES

Design Guidelines

FIGURE A

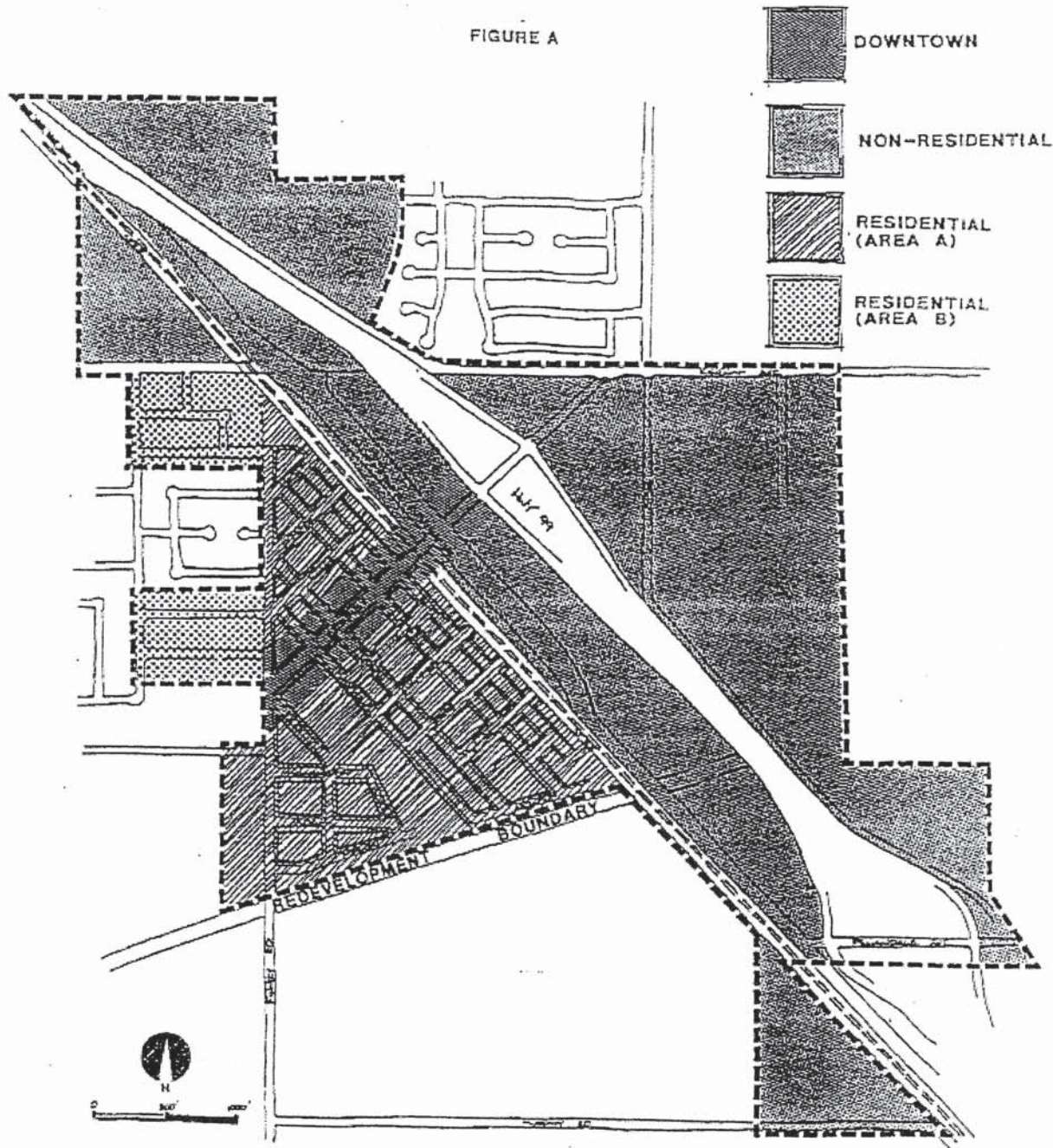

SALIDA  
COMMUNITY DESIGN GUIDELINES

DISTRICT MAP

***THIS PAGE INTENTIONALLY LEFT BLANK***

I. DOWNTOWN COMMERCIAL DISTRICT

Downtown Salida, (Broadway Street corridor west of Highway 99), is rundown and in a state of decay. The buildings lack architectural and site design consistency, landscaping, and pedestrian amenities. They contain incompatible uses and contribute to downtown Salida's economic dysfunction (Claire, 1990).

*Goal: Create a downtown commercial district that provides an environment for economic growth, pedestrian movement and involvement, aesthetic harmony, parking, and safety.*

A. Site Planning Guidelines

Improved site planning in the downtown core (Broadway) will increase pedestrian involvement and safety, create a traditional "downtown" look with strong street edges and pedestrian "boardwalks", and provide a "small town" feeling for Salida residents and visitors.

- 1. Building Location: Orient buildings parallel with the street.

*Intent: Discourage placement of buildings which are inconsistent with the character of a downtown street.*

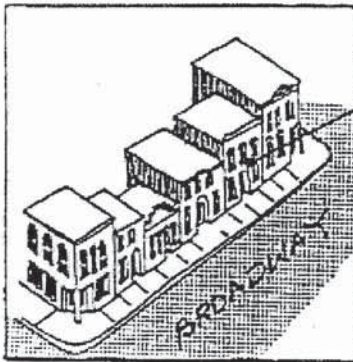

BUILDING FACADES  
EVEN WITH SIDEWALKS.

THIS

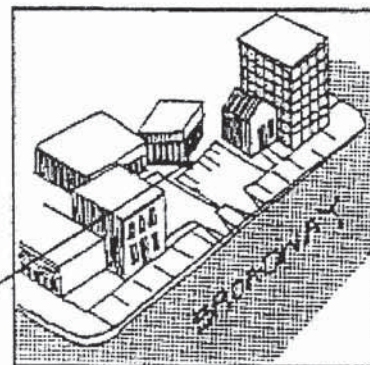

VARIOUS BUILDING  
LOCATIONS INCONSISTENT  
WITH A "DOWNTOWN"  
CHARACTER.

NOT THIS

- 2. **Setbacks:** Site downtown buildings flush with the sidewalk on the front and side property lines.

*Intent: Create a strong linear experience along storefront sidewalks for the pedestrian and a downtown character for Salida.*

FRONT AND SIDE SETBACKS WHICH ENHANCE THE PEDESTRIAN EXPERIENCE AND MAINTAIN A LINEAR SIDEWALK EDGE ARE ENCOURAGED

VARYING REAR SETBACKS CREATE SPACE FOR PARKING, PLAZAS, AND LOADING

ZERO SETBACK AGAINST STREET R.O.W.

ENCOURAGE "WALL TO WALL" BUILDING REPLACEMENT. PROVIDE OCCASIONAL GAPS BETWEEN BUILDING FOR PEDESTRIAN ACCESS TO REAR PARKING AREAS.

**THIS**

INCONSISTENT BUILDING SETBACKS DISRUPT A PEDESTRIAN ORIENTED DOWNTOWN

**NOT THIS**



- 3. **Parking Lots:** Locate parking lots behind buildings that front Broadway. Provide access to these lots with mid-block breaks in the street facades. Provide landscaped entries and canopy trees for shade. Prohibit parking lots that front on to Broadway.

*Intent: Provide an uninterrupted street facade along Broadway.*

(Refer to Parking Lot Design for queuing, screening, and entry design, pages 1-86, 1-87, and 1-88).

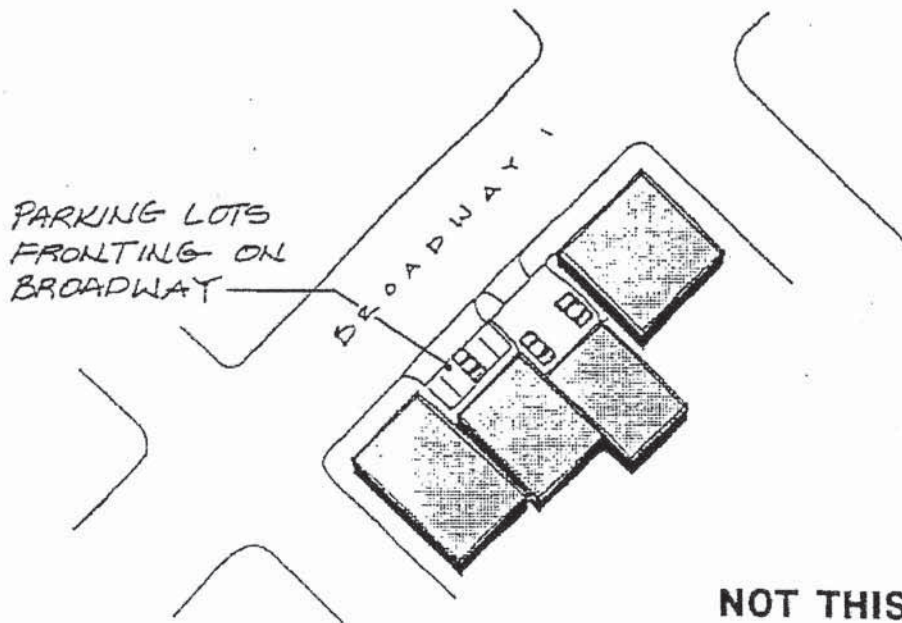
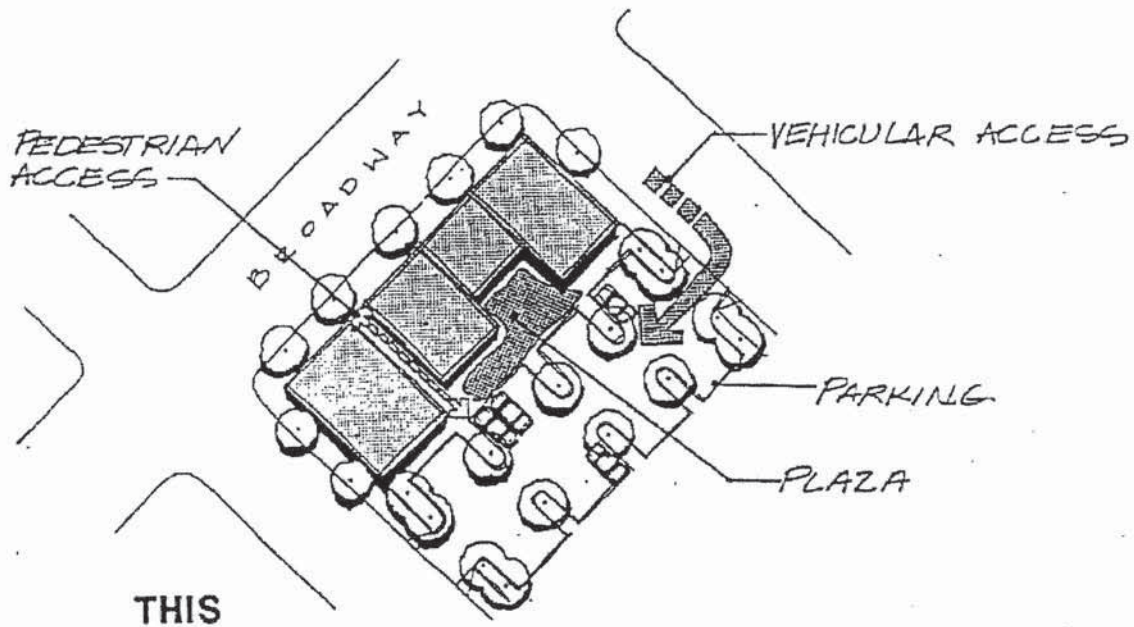

- 4. Corner Buildings: Corner buildings should incorporate architectural features such as building cut-offs and walk-through arcades.

*Intent: Enhance pedestrian movement, driver visibility, and streetscape variety.*

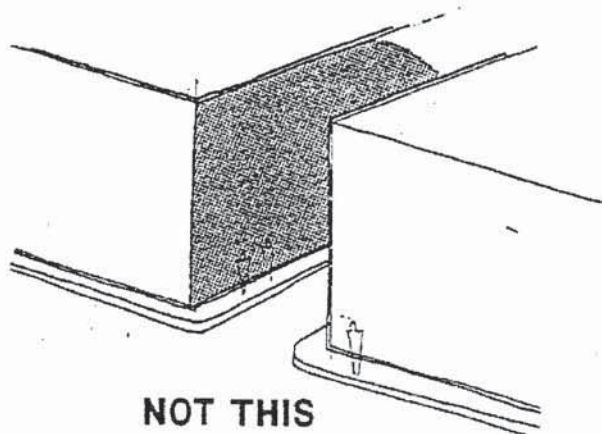
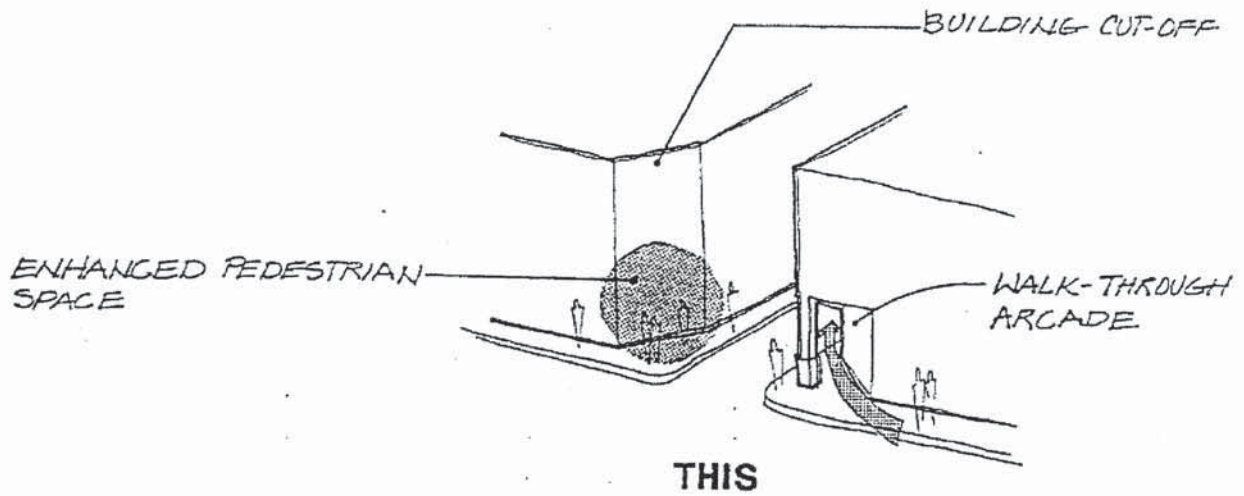

5. **Pedestrian Orientation:** Site and design buildings with facade variations and pedestrian-oriented streetscapes.

- \* Encourage facade variations such as (but not limited to) recessed entry features, bay windows, planter boxes, sidewalk cafes, and plazas.
- \* Provide streetscape with the creative use of lighting, street furniture, landscaping, and enhanced paving.

*Intent: Maintain Salida's "small town" character and create a strong pedestrian environment.*

Refer to page 1-73.

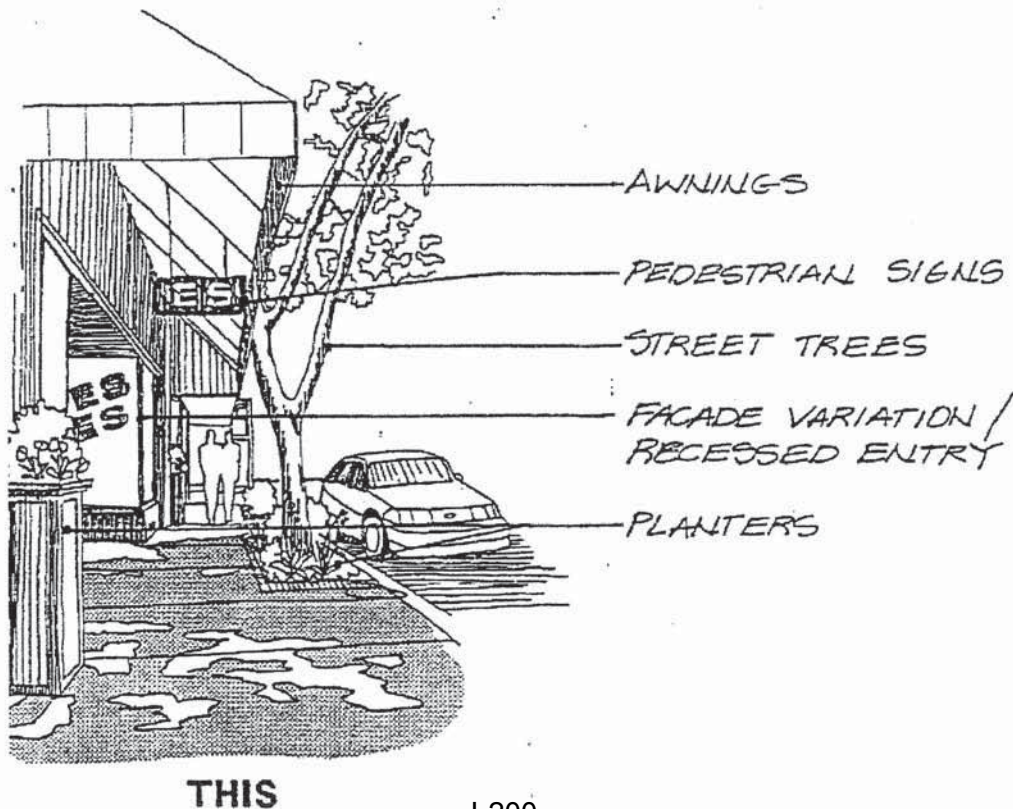
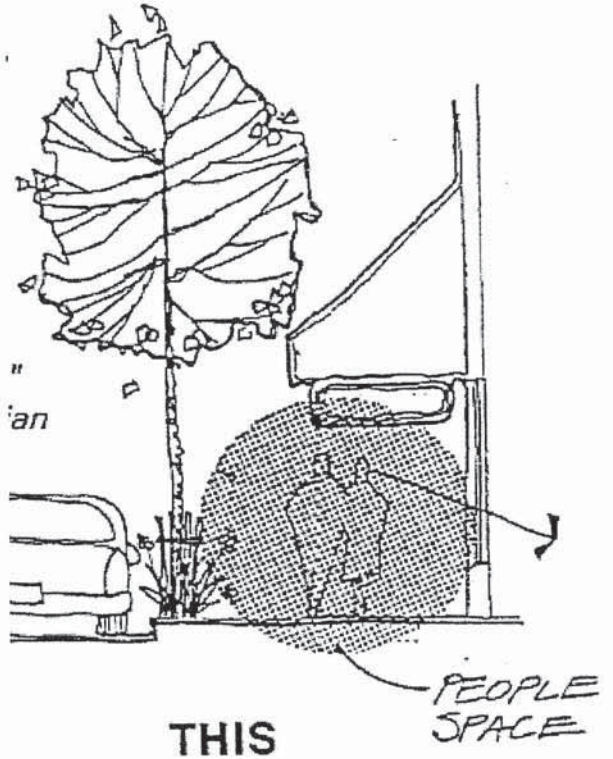

- 6. Sidewalks and Paving: Sidewalks, curbs, and paving design should reinforce a "small town" character rather than create an urban feeling.

- \* Provide continuous storefront sidewalks (minimum 10-foot wide), with integral curb and gutter throughout the downtown commercial areas.

Refer to Page 1-65.

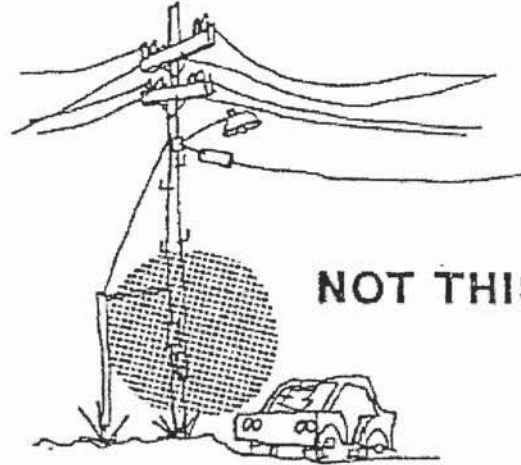

- \* Encourage special paving, colored concretes, and the development of a consistent paving pattern throughout the downtown core.

*Intent: Reinforce a continuous pedestrian-oriented downtown street environment with a system of storefront sidewalks.*

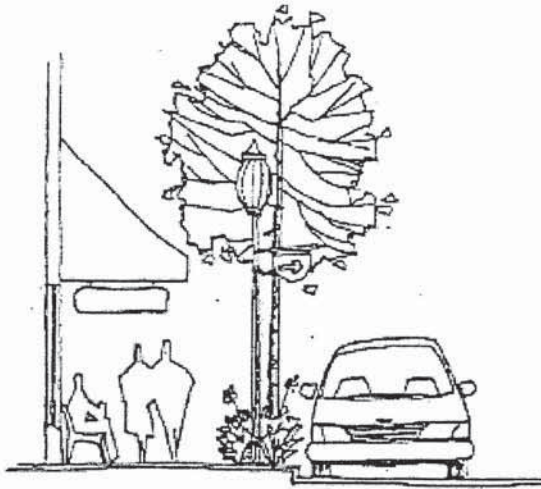

**THIS**

STREET LIGHTING AND SIGNAGE

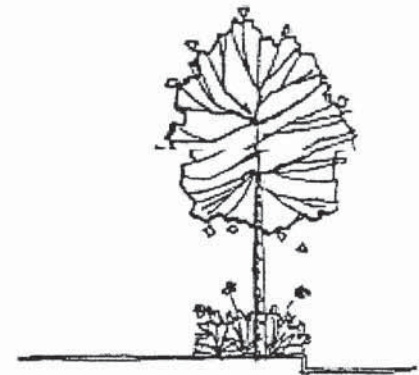
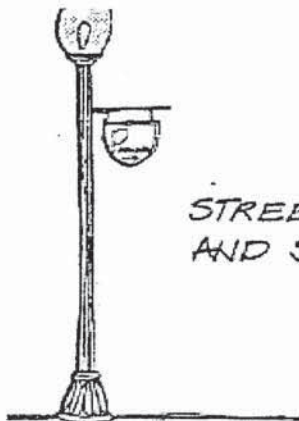

STREET TREE AND PLANTER



WOOD PLANK



COLORLED CONCRETE

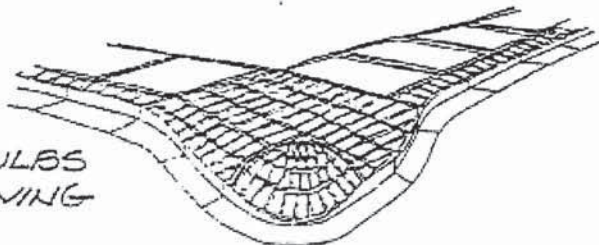

CORNER BULBS  
SPECIAL PAVING



TEXTURED CONCRETE

- \* Develop sidewalks that create a series of paths and linkages to bring the community together.

*Intent: Make walking downtown from other parts of town an inviting and variable alternative to the automobile.*

- \* Provide a continuous edge along Broadway with landscaping or a low wall/wood fence (Materials, page 1-68), where there is not a building adjacent to the sidewalk.

*Intent: Define the pedestrian space along Broadway with an uninterrupted edge along the sidewalk.*

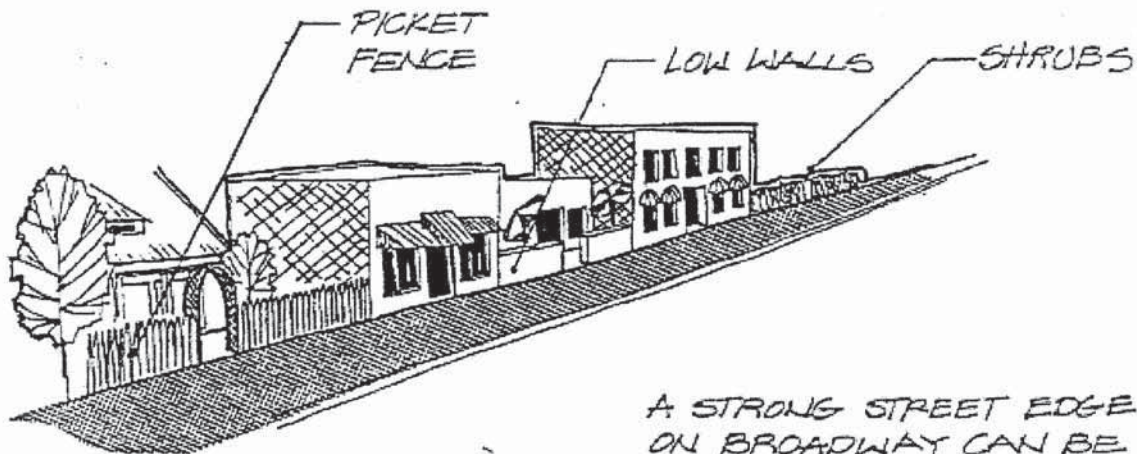

*A STRONG STREET EDGE  
ON BROADWAY CAN BE  
MAINTAINED WHERE SETBACKS  
VARY BY USE OF LOW  
WALLS, FENCES AND SHRUB  
AREAS*

7. Landscaping: Creative use of landscape will soften building edges, enhance pedestrian scale, and the overall visual appearance of the downtown core.
- \* Encourage the use of planters, planter boxes, and street trees along Broadway.
  - \* Provide street trees in front of every business or every 50 feet, whichever provides the greatest number of trees. Condition new developments and rehabilitation of existing buildings to provide street trees.

*Intent: Provide scale, softer edges, people spaces, shading definition of sidewalk space, aesthetics, and to add to the overall character of the downtown core.*

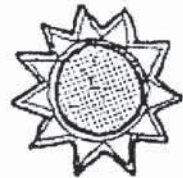

STREET TREES EVERY  
50 FEET

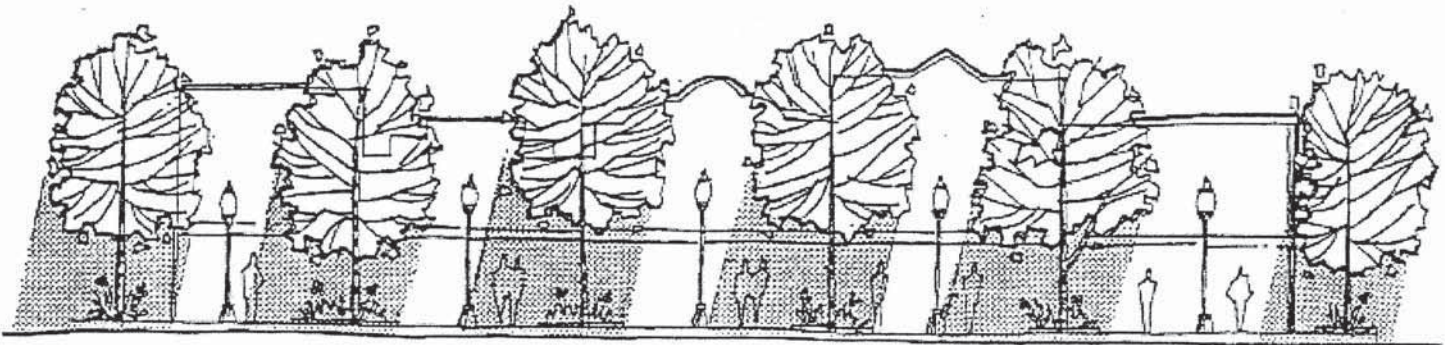

**THIS**

8. Infill: Vacant lots detract from the downtown and the pedestrian experience. Efforts to infill the empty lots should be made.

*Intent: Develop a uniform facade along Broadway to enhance the pedestrian experience.*

Refer to pages 1-65 and 1-82.

VACANT LOT DISRUPTS DOWNTOWN  
PEDESTRIAN EXPERIENCE

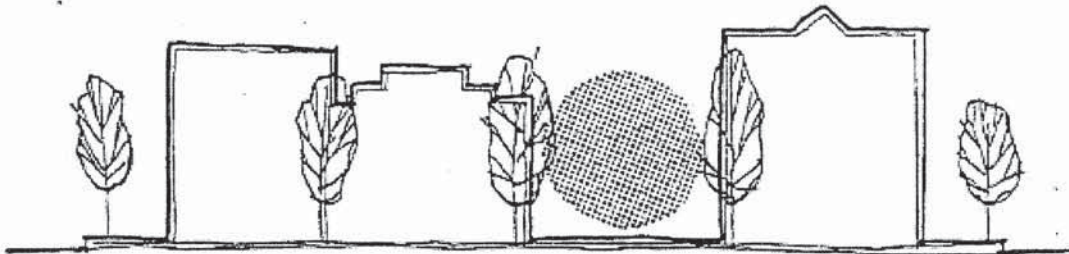

**NOT THIS**

**B. Architectural Guidelines**

Integration of certain architectural features in the downtown buildings will restore and enhance Salida's historical past. Salida is a small agricultural town with a substantial historical influence from the railroad. The following architectural guidelines promote elements of a typical California agricultural/western town with historical railroad influence.

**1. Desirable Features:**

- \* Second story balconies and decks
- \* Decorative parapets and varying roof lines
- \* Plaster or lap siding, both in light tones
- \* Recessed entries/facade relief
- \* Signage with historic significance

**2. Undesirable Features:**

- \* Shingled awnings or canopies
- \* Mansard roofs
- \* Dark exterior building colors
- \* Blank facades/Use of inappropriate facade materials

**3. Materials: Require materials that are compatible in quality, color, texture, finish, and dimension to those existing downtown.**

- \* Stucco (smooth finishes)
- \* Wood as primary and accent
- \* Brick as primary and accent
- \* River rock as primary and accent
- \* Unglazed tile as accent or roofing material
- \* Split-faced masonry block
- \* Canvas/cloth awnings and canopies





4. Rhythm, Massing, and Scale: Rhythm is a pattern reflected in the relationships of buildings or the components of a building to one another. Consistency in the massing and scale of buildings will begin to establish an appropriate rhythm for Salida's Downtown Commercial District.
- \* The massing of adjacent buildings should complement each other by maintaining relative consistency. The mass of the structure should be controlled by incorporating vertical and horizontal articulation that is consistent with adjacent buildings.
  - \* Building scale refers to the size and shape of a building as well as the building's components (i.e., windows, doors, canopies, etc). The scale of building components should relate to the scale of the entire building, and building scale should be consistent throughout Salida's Commercial District. There should be greater emphasis on creating a building scale which will emphasize human scale.
  - \* Human Scale: Relationship between the size of a building and its features to the size of a person is important to a downtown's character. Buildings and building elements should be intimate and at human scale at the street level.

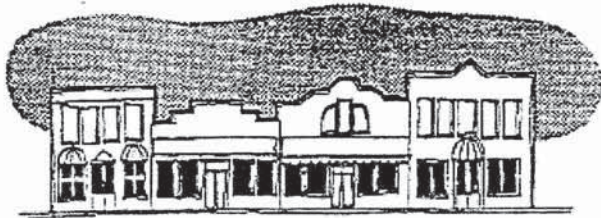

**THIS**

*BUILDINGS COMPLIMENT EACH OTHER WITH CONSISTENT SCALE, WIDTH AND MASS*

*BUILDINGS TOTALLY UNRELATED*

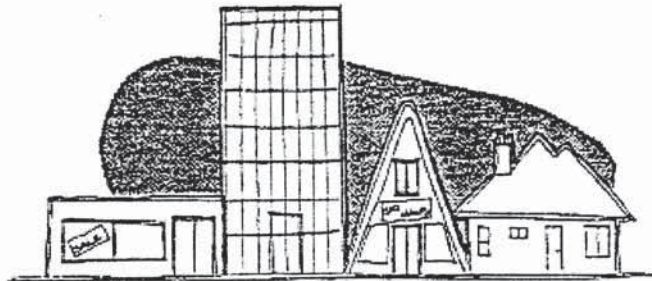

**NOT THIS**

- 5. Height and Width: Buildings should vary in height and width while remaining within the parameters of those set for downtown.

- \* Require new buildings to be constructed at heights that are compatible with the height of existing adjacent buildings.

*Intent: Create an interesting and appropriate roof line as a backdrop to Broadway.*

HEIGHT VARIATION



THIS

CONSISTENT FACADE WIDTH

- 6. Proportion: The relationship between the width to height of the front elevation of a building must be in proportion to those of the building's neighbors.



NOT THIS

7. Roofs: Roof lines of new structures should conform to existing parapet and false front roof lines found in the downtown and reflect the western theme of an agricultural/railroad town.

- \* Avoid blank parapets
- \* Provide relief and detail
- \* Conceal roof equipment
- \* Avoid pitched roofs or mansards

*Intent: Encourage roofs which are consistent with existing roofs or buildings with historical significance.*

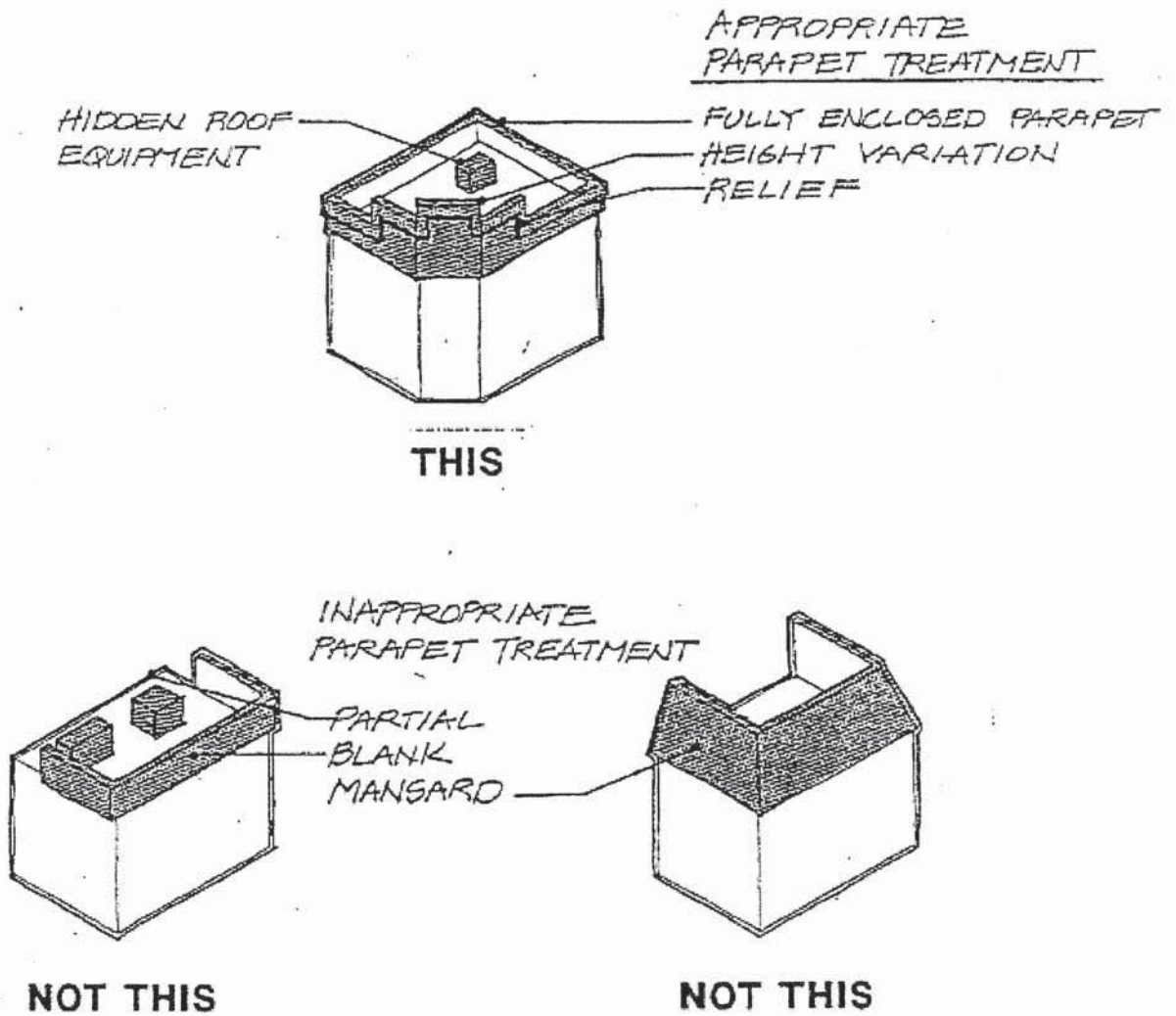

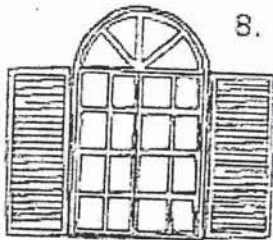

Doors and Windows: The style and proportions of doors and windows are very important elements for setting the character and style of buildings.

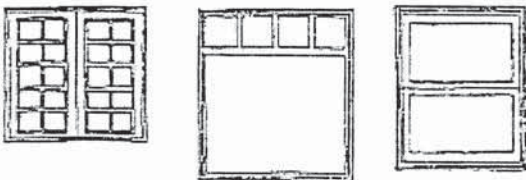

PAINTED WOOD FRAMES  
CLEAR GLASS

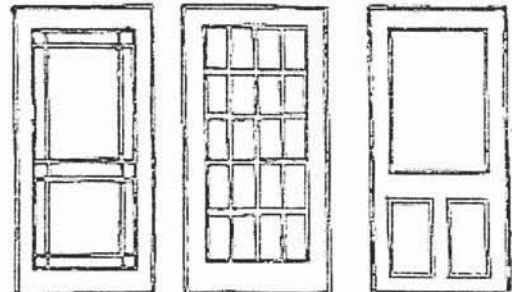

THESE

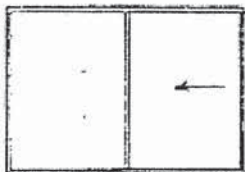

GOLD OR SILVER METAL FRAMES  
HORIZONTAL SLIDER

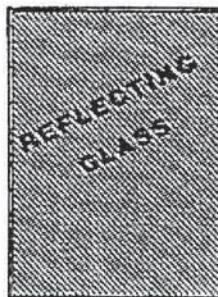

TINTED GLASS  
UNPAINTED METAL

NOT THESE

- \* Provide windows at street level to create links between pedestrians, streetscape, and businesses.  
  
*Intent: Add variety and detail to buildings while discouraging use of plain and inappropriate doors and windows.*
- \* Proportion of Openings Within Facade: Width to height relationships of new building's windows and doors must be in proportion to adjacent buildings. Windows should not extend all the way to the ground. Provide a minimum 12" base.

- 9. Awnings and Canopies: Encourage awnings and canopies for use over building openings. In addition to weather protection and shade, they add character, color, interest, scale, and identity to individual buildings. (See page 1-68 for desired awning and canopy materials).

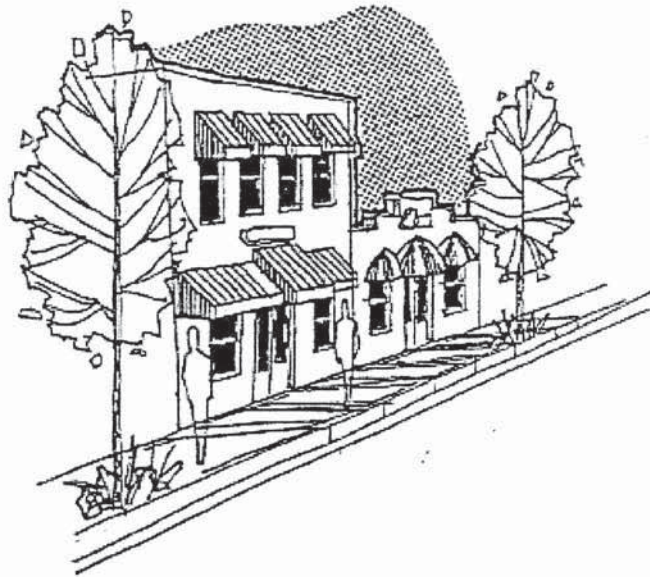

AWNINGS CREATE  
BUILDING RELIEF  
AND PEDESTRIAN  
SPACE

**THIS**

10. **Signs:** Require appropriate signage that relates to the size and scale of the business, to the pedestrian scale, and enhances the overall downtown image.

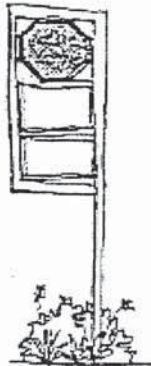

**THIS**

\* Discourage building signs that advertise merchandise. They contribute to a cluttered and confusing streetscape. Discourage signs above the roof or parapet line.

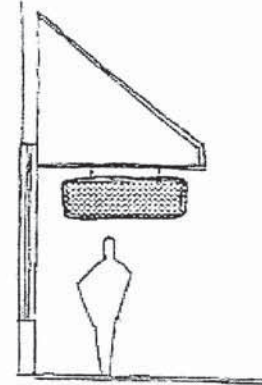

*PEDESTRIAN SIGNS*

\* Suggested sign types are: Flush-mounted signs with individual cut letters, hanging signs, window signs, icon/graphic signs, externally lighted neon tube signs, and awning signs.

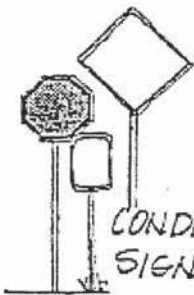

*CONDENSE PUBLIC SIGNAGE*

\* Locate signs within the "Auto Zone" or the "Pedestrian Zone" described below.

*Intent: Attractive and informative pedestrian-oriented streetscape and shopping area.*

**NOT THIS**

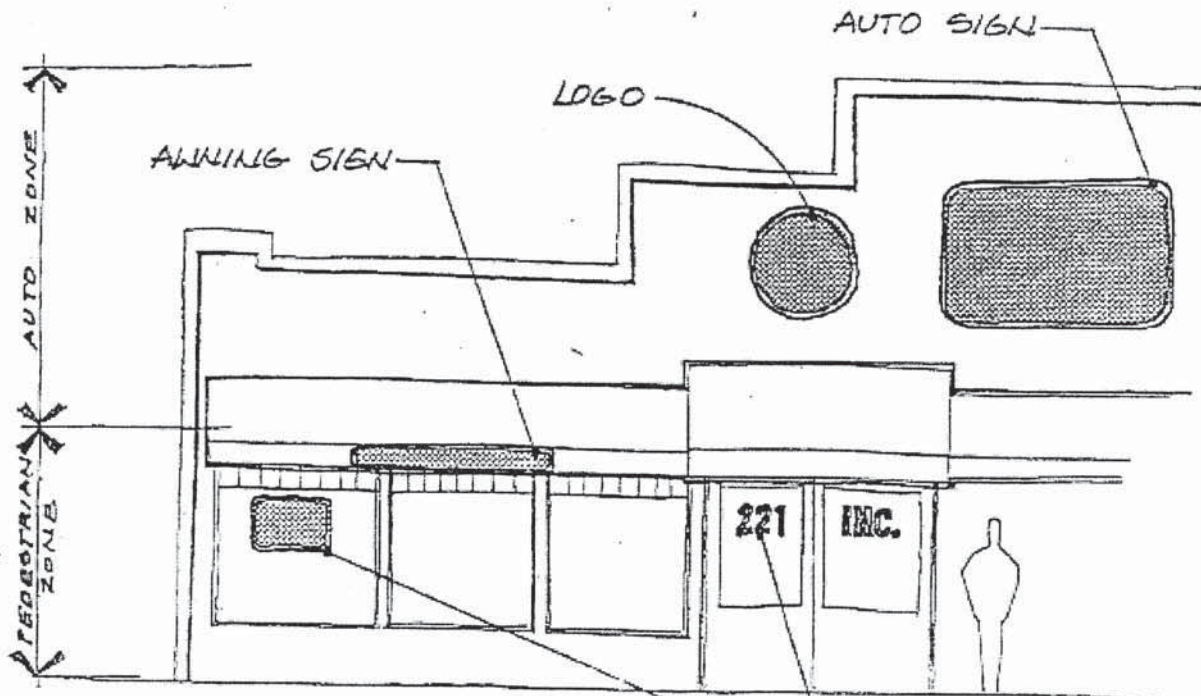

**COMMERCIAL SIGN DIAGRAM**

*DOOR AND WINDOW SIGNS*

11. Colors: Colors and materials used on buildings are important in creating variation while maintaining an overall consistency in the downtown.
- \* Require larger buildings to be painted with subtle colors.
  - \* Discourage intense hues of color and the use of more than one vivid color per building.
  - \* Avoid colors that create disharmony with other buildings.
  - \* Accept colors that relate to the natural materials of the building.

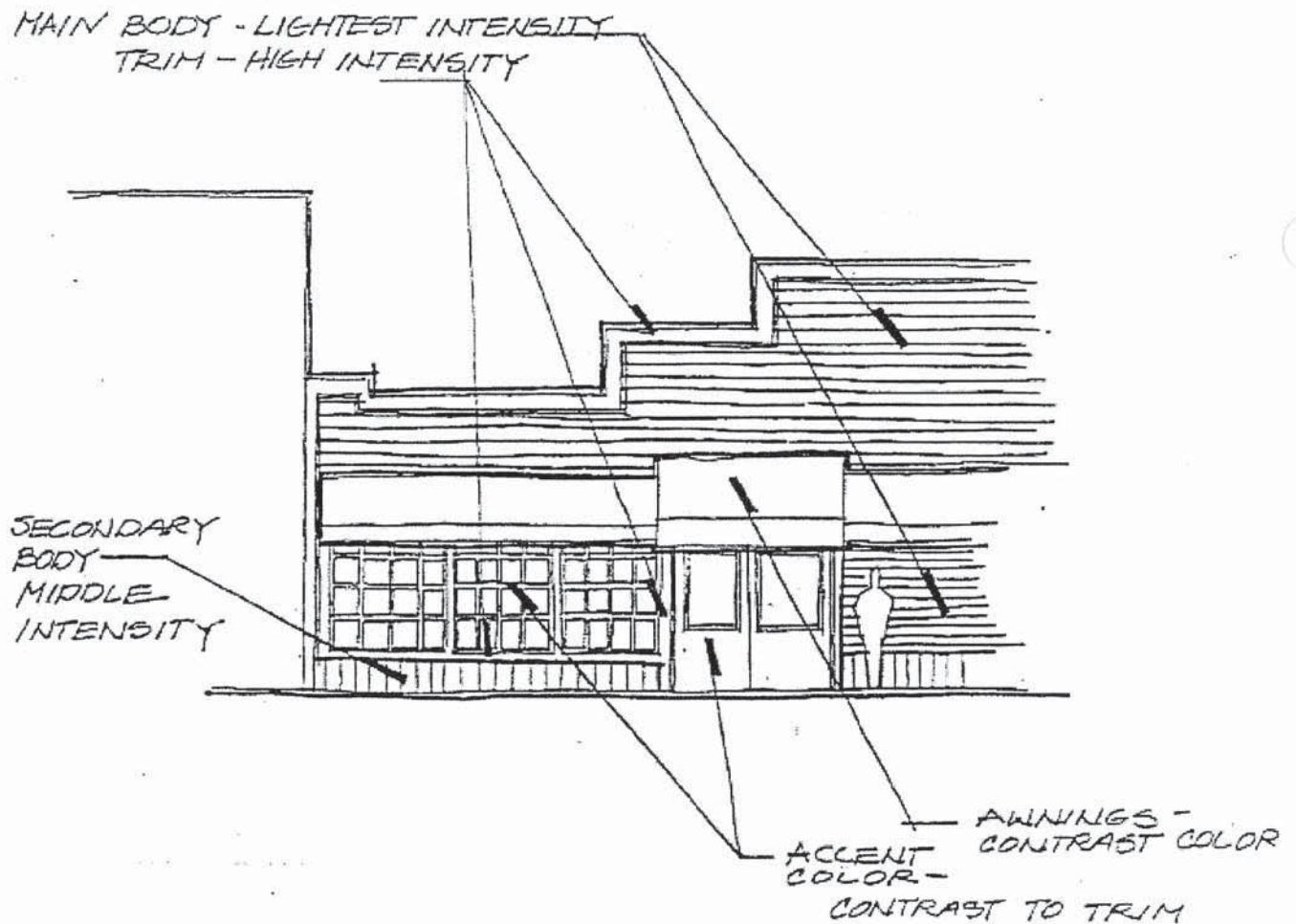

**BUILDING PAINTING DIAGRAM**

- \* Allow the use of contrasting colors to accentuate building entry features and architectural details.

*Intent: Prevent inappropriate and unattractive painting schemes in the downtown area. Encourage consistency in overall color palette for the downtown area.*

12. Renovations and Remodeling: Encourage buildings which do not meet architectural design standards to conform by facilitating cosmetic changes such as: repainting, new signage, landscaping, cloth awnings, addition of street trees, and removal of undesirable features.

Refer to pages 1-66, 1-73, 1-74, and 1-75.

*Intent: Updating existing downtown buildings so they are consistent with new development.*

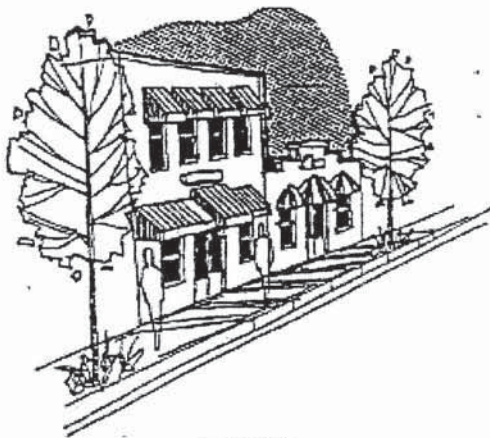

AWNINGS  
STREET TREES

**THIS**

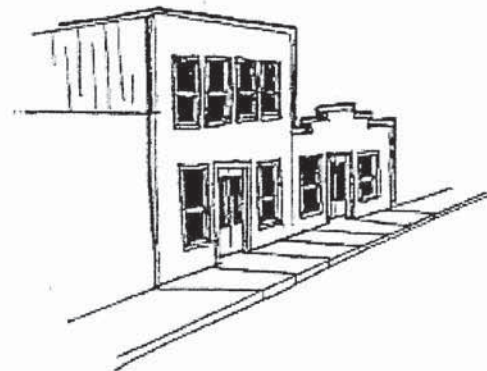

**NOT THIS**



**C. Downtown Streets**

Broadway, as the main street in the commercial area, is substandard. The street's current condition hinders circulation, disrupts parking, endangers pedestrians, and creates a negative image of downtown Salida.

Broadway has a 100-foot right-of-way (ROW). The existing space that is created by this ROW is too large to achieve pedestrian orientation along the street. Enhancement of the existing median by the addition of street improvements will restore human scale.

Salida's commercial streets should provide for circulation, parking, pedestrian movement, and create an aesthetically pleasing image.

The following street guidelines are intended to improve circulation, parking, pedestrian movement, aesthetics, and promote safety.

1. Street Improvements and Design: Repave existing commercial streets, provide line striping, curbs, gutters and sidewalks, and on-street parking (either parallel or angled).

Refer to pages 1-63 and 1-64.

- \* Design streets to safely accommodate all forms of local transportation such as trucks, cars, bicycles, and pedestrians.

*Intent: Promote walking and bicycle riding as energy efficient alternatives to automobiles; also, minimize the impact of delivery trucks on traffic flow and parking.*

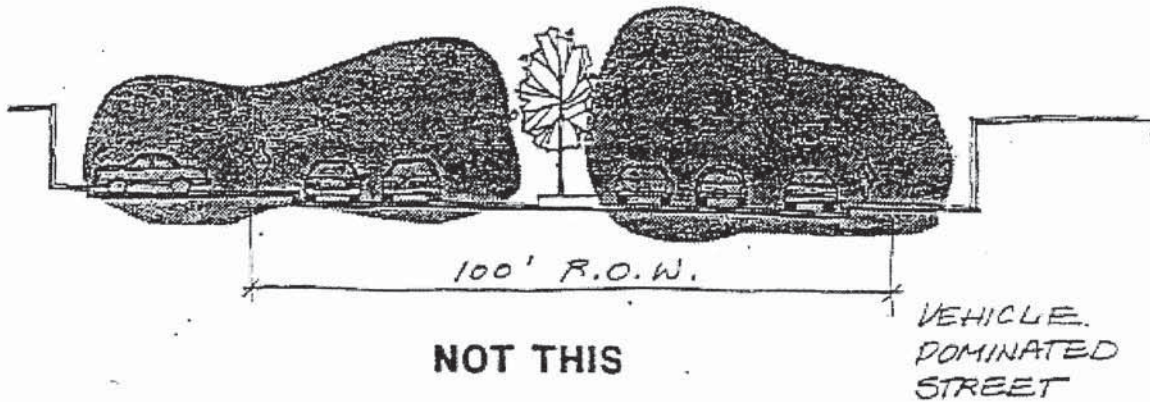
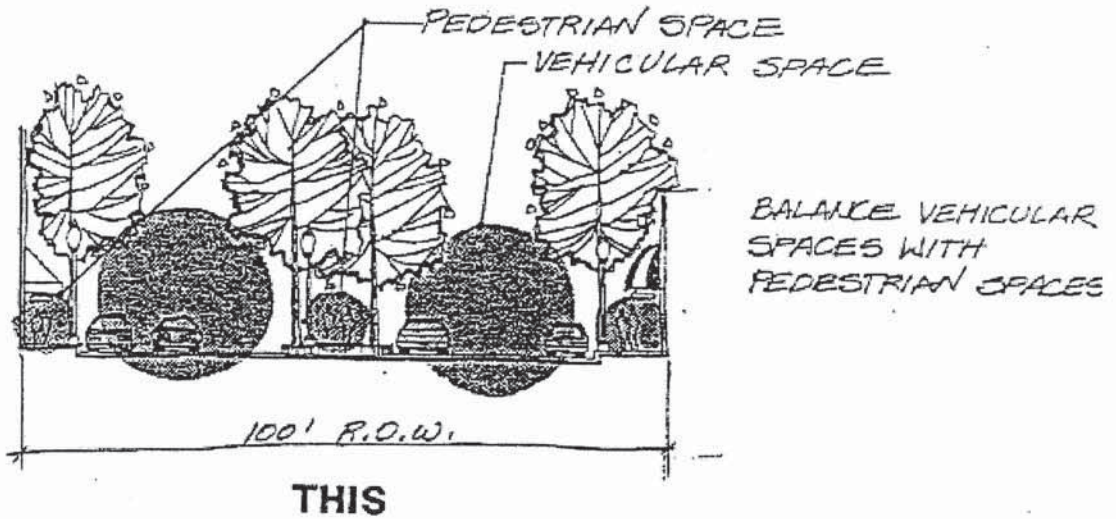

- 2. On-Street Parking: On-street parking provides a buffer between the pedestrian and vehicular traffic and is essential to the economic vitality of the downtown district.

- \* Provide designated on-street parking wherever possible on Broadway. Every effort should be made to maximize the number of available stalls (i.e., diagonal on-street parking).

*Intent: Maximize convenient parking opportunities in the downtown area.*

- 3. Circulation: Re-engineer intersections where necessary to provide safer and more logical traffic circulation.

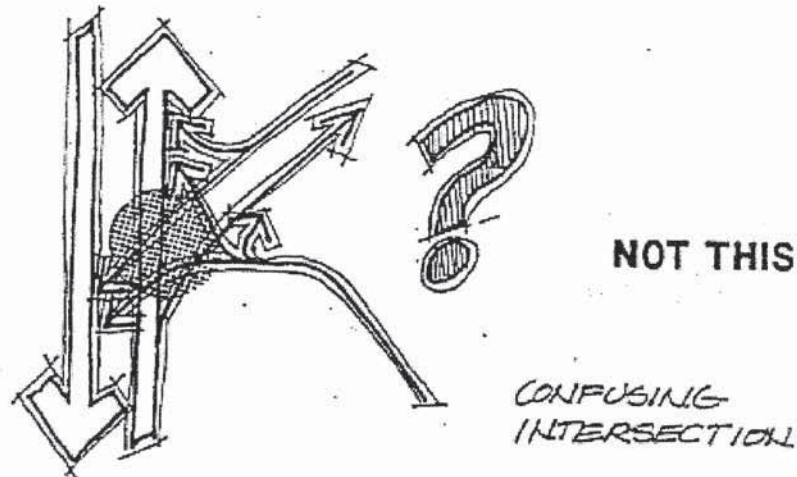

- 4. Traffic Speed: Design roads to encourage traffic flow at a safe rate of speed. Post speed limit accordingly.

*Intent: Slow traffic to allow for safe pedestrian movement and parking in and around Broadway.*

- \* Clear signage, posting speed limits, and legal enforcement on Broadway.
  - \* Stop sign placement at all intersections on Broadway.

5. Median Treatment: The existing median is a large unimproved area located in only a small section of Broadway. The median is currently used as a make shift parking lot and contains mature landmark trees.
- \* The median design should extend to other portions of the Broadway corridor. Curbs, sidewalks, lawn, trees, and other park-like amenities should be incorporated into the median design.
  - \* Care to existing median trees should be observed during any improvements to the median.
  - \* The median should provide aesthetic and visual cohesion to the downtown.

Refer to page 1-105.

*Intent: Balance vehicular environment with the pedestrian environment to create a balanced street environment.*

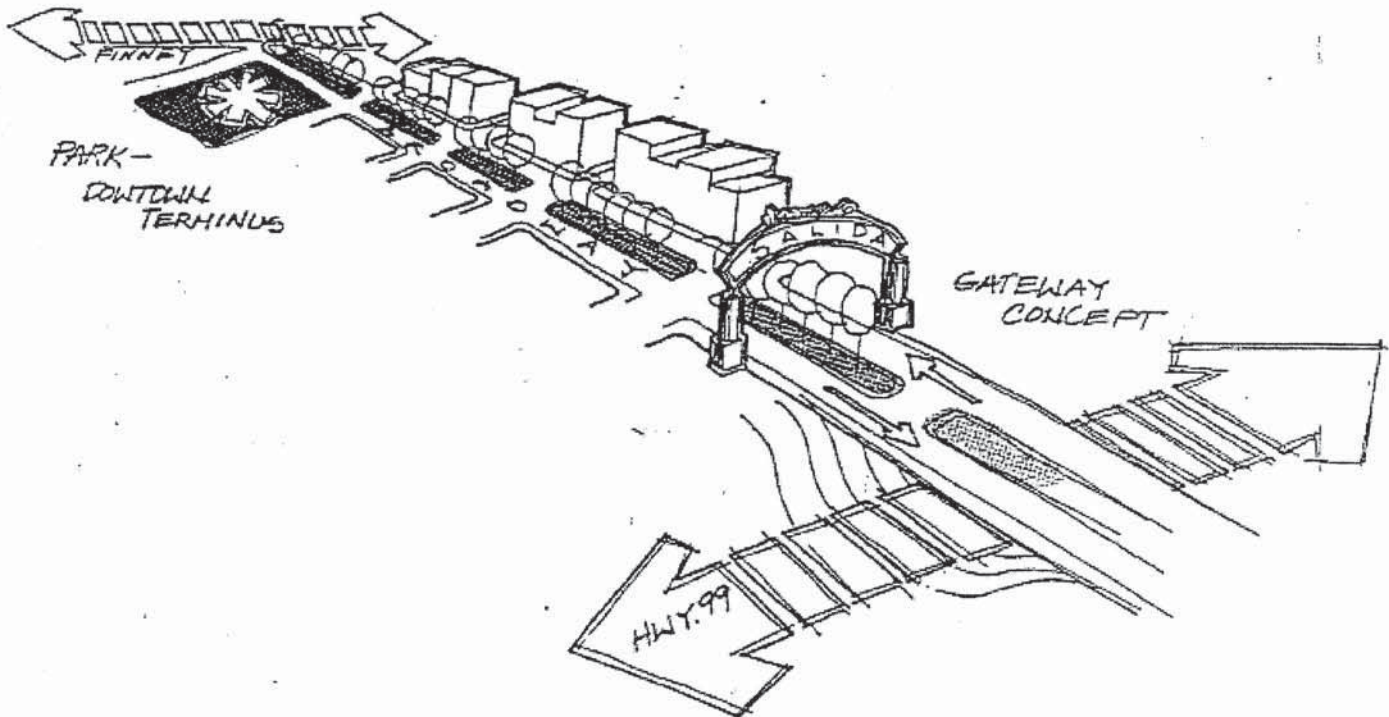

**DOWNTOWN CONCEPT**

- 6. Gateway: The intersection of Broadway and Old Highway 99 provides an opportunity for commercial development, and also could provide a gateway to downtown.

*Intent: Gateway to serve as a community landmark to highway travelers, as well as define the edge of the downtown commercial area.*

- 7. Landmarks: Landmarks serve an important function in defining spaces and increasing the identity and orientation of an area. Encourage appropriate use of landmarks throughout Salida.

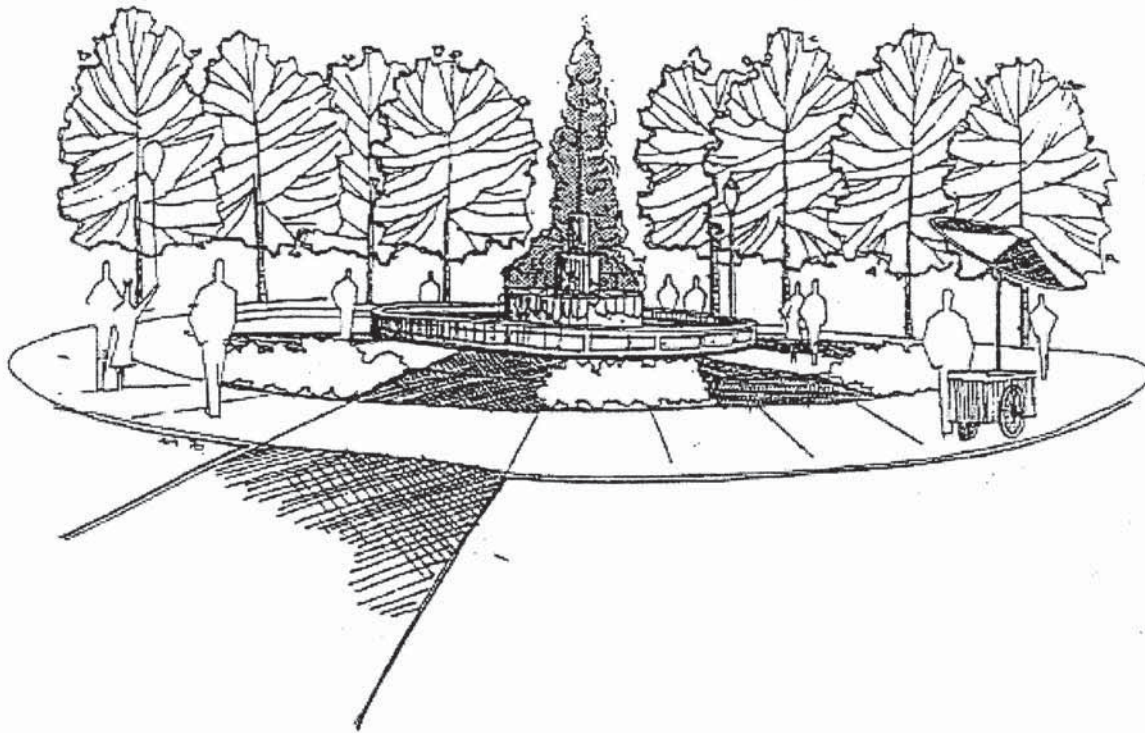

**D. Economic Development**

According to the Stanislaus County Redevelopment Feasibility Assessment, Salida's downtown is ideally positioned to take advantage of growth occurring on the community's fringes. Therefore, Salida should develop a diverse and strong business community.

1. New Businesses: Encourage new viable businesses and services to locate in the Salida downtown. Refer to page 1-67.

*Intent: Create an economically viable commercial and service center in downtown Salida.*

2. Mixed Uses: Encourage a variety of mixed uses in the downtown (commercial, service, residential, professional).

- \* Encourage residential development downtown to increase the hours of activity in the area.
- \* Implement vertical zoning downtown that restricts first floor residential development.

*Intent: Provide a dynamic environment to accommodate a variety of lifestyles, promote economic growth, and promote and provide affordable housing.*

**MIXED USE DEVELOPMENT**

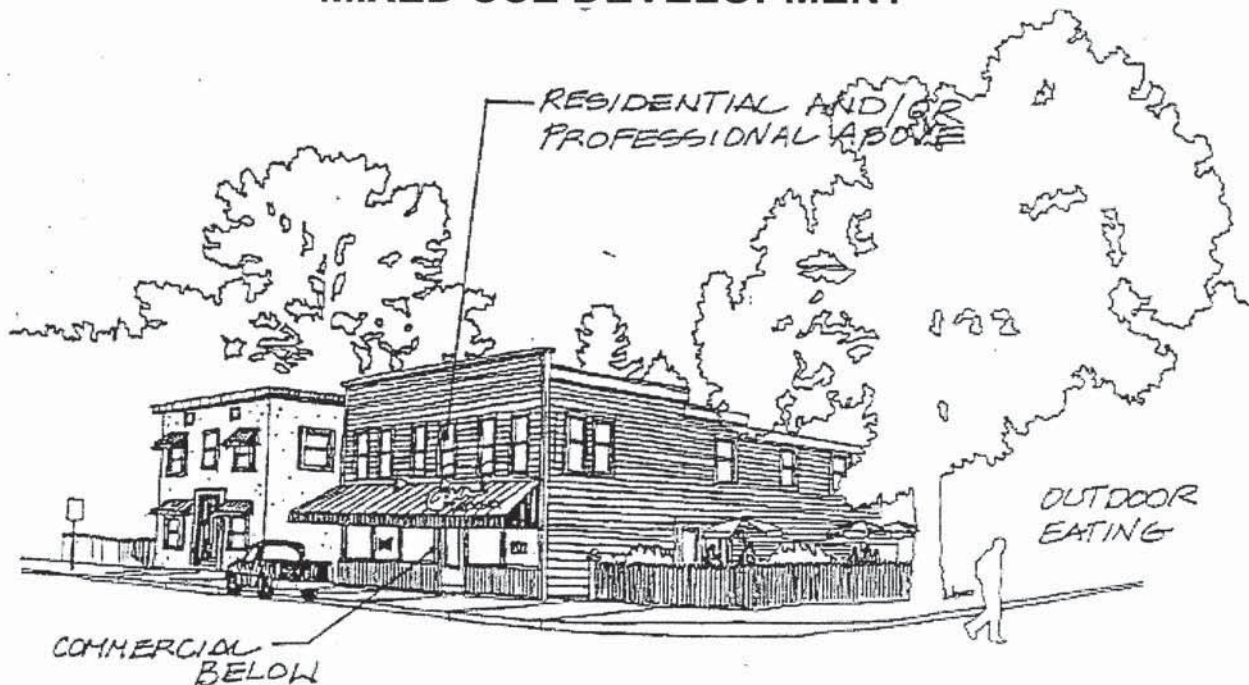

**II. NONRESIDENTIAL DISTRICT**

Outside Salida's main downtown commercial district, there are several commercial, office, public service, and industrial areas. The following guidelines apply to all areas that are outside the Broadway "downtown commercial" core and are not zoned residential.

These areas are lacking in site planning, architectural consistency, and road improvement standards. The guidelines will help obtain basic consistencies to enhance and improve pedestrian movement and safety, traffic flow, parking, and aesthetic appearance of these areas.

*Goal: Create an aesthetically-pleasing, secondary commercial district that functions economically while enhancing Salida's "small town" character.*

**A. Site Planning**

1. **Setbacks:** Require a 15-foot minimum street setback for nonresidential buildings and a 15-foot minimum setback for parking lots.

\* Recommend use of low walls of native stone, wooden rail fences, berms, and native rock in landscape areas along streets to provide visual definition and interest.

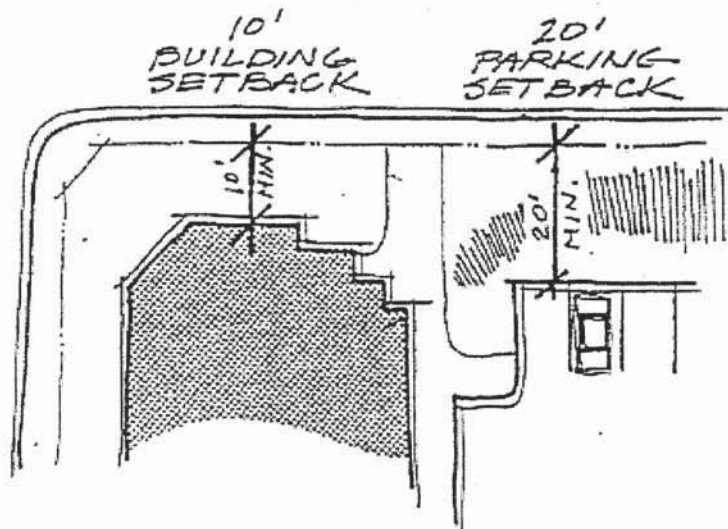

- 2. Building Location: Locate buildings adjacent to at least 25% of the road to minimize parking lot frontage. Provide a minimum of one public street entrance. Relate to adjacent buildings and avoid double blank walls that face each other at a property line.

*Intent: Avoid parking lot dominated streetscape of all nonresidential areas.*

- 3. Building Coverage: Limit all site disturbances involving grading, building, and parking lots to 70% of the total site, excluding setbacks. The remaining should be left in open space and landscaping.
- 4. Building Footprint: Articulate building footprints by use of insets, corners, and jogs that emphasize pedestrian movement and interest.

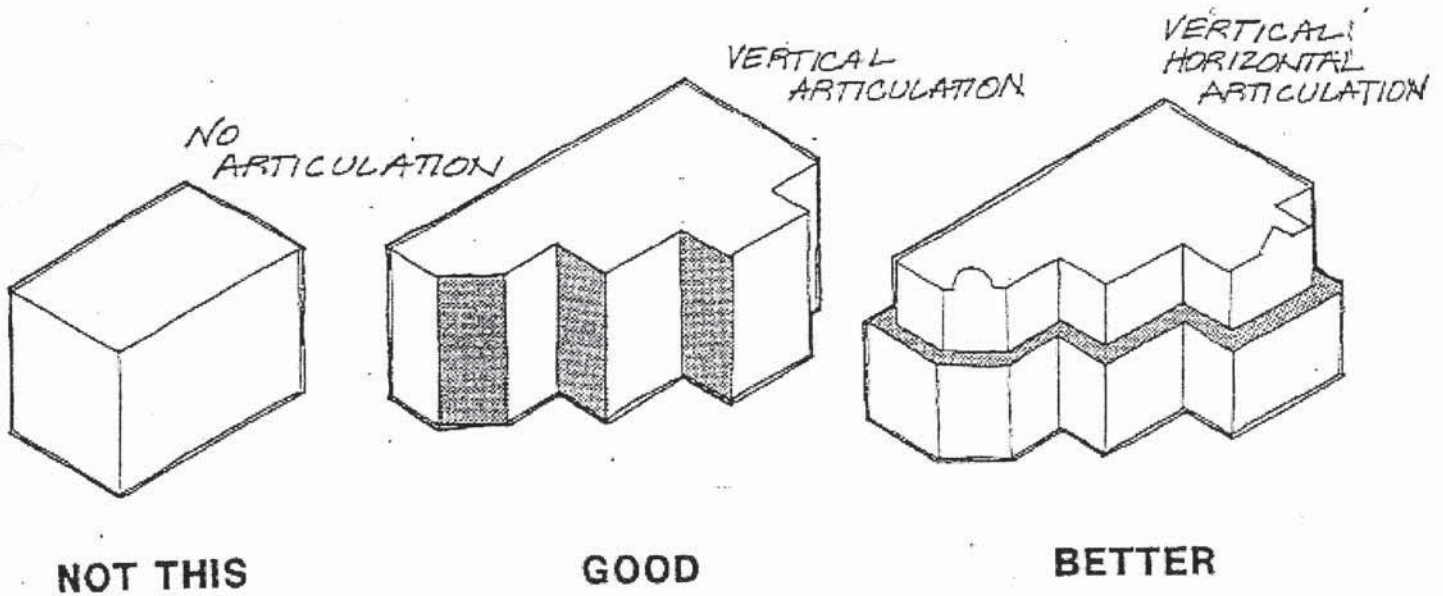



- 5. Service Areas: Orient buildings to hide all service and storage areas from public street view. Incorporate these areas into the main building whenever possible.
- 6. Utility Areas: Locate utility areas such as meter boxes, water meters, trash dumpsters, etc., to the rear of building, or screen them from street view.

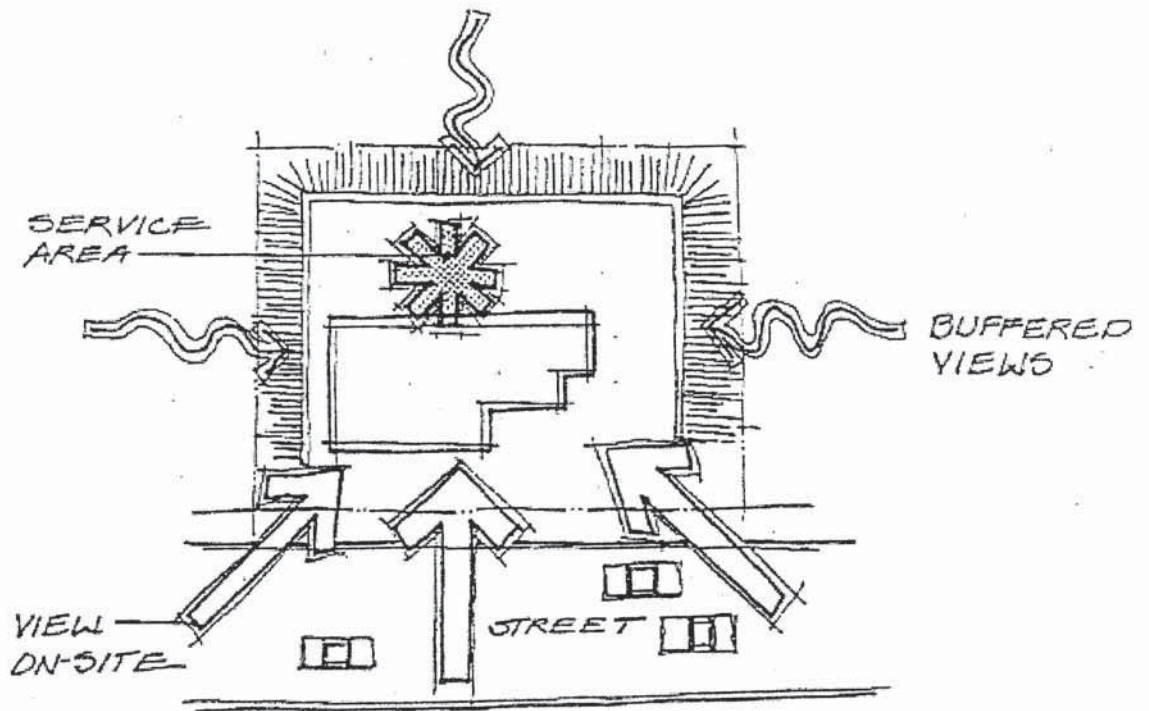

**THIS**

7. Parking Lot Design: Encourage use of landscaping and enhanced paving surfaces (i.e., stamped concrete, paver tiles, etc.), to minimize large expanses of uninterrupted pavement areas.
- \* Orient parking aisles perpendicular to the building entrance.
  - \* Inter-relate parking lots (whenever possible), with adjacent parcels to provide pedestrian and vehicular connection.
  - \* Lot Building Transition: Maintain a transition space between parking lot and building. Require a 5-foot wide minimum space with landscaping.

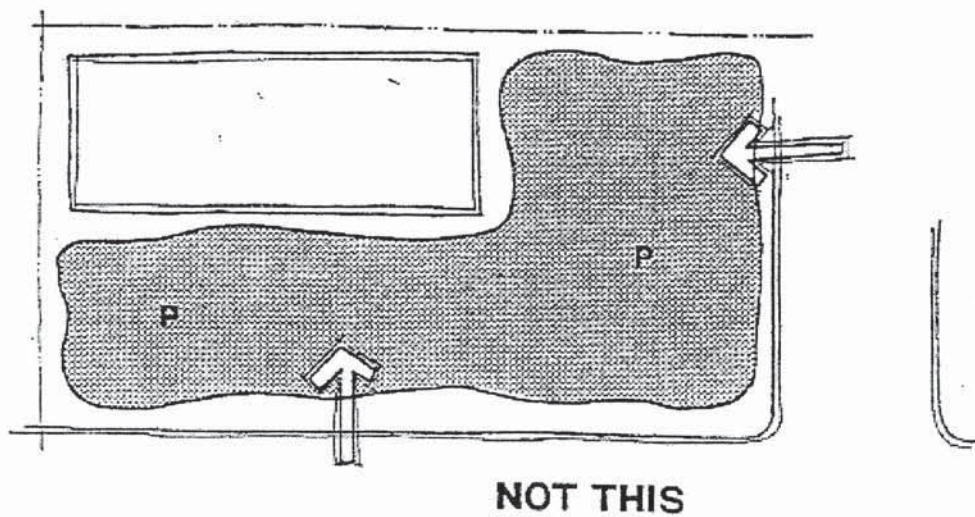
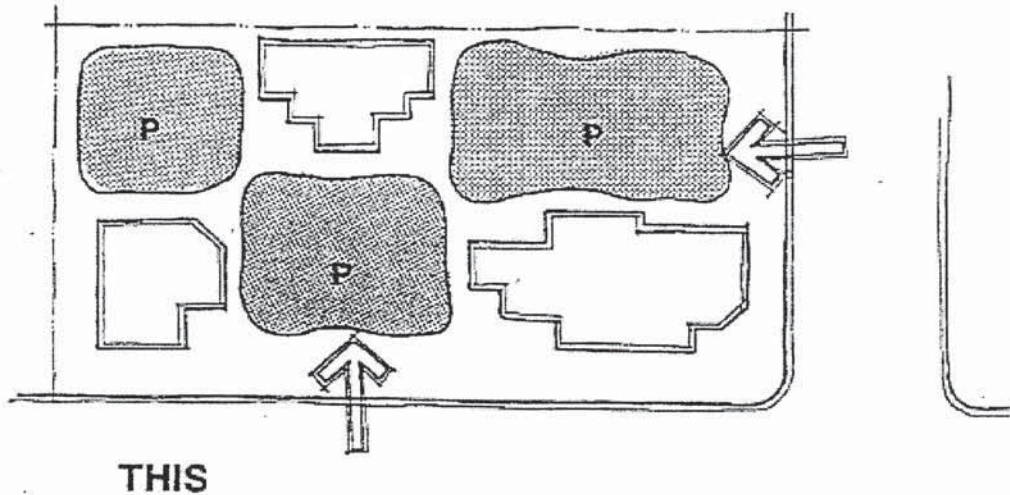

- \* Landscape: Encourage canopy tree landscaping in parking areas, and special landscaping treatment for parking lot entrances.
  - \* Provide:
    - Planted island or breaks (five-foot wide minimum) every six spaces
    - Two trees each break
    - 15-gallon minimum tree size
    - Two trees at the end of each row of spaces
8. Entry Design: Locate entries to corner buildings on side streets (less busy). Locate parking entries at least 150 feet from intersections.
- \* Require parking lot entries for commercial developments to be at least 200 feet apart and a minimum width of 25 feet. Combine driveways for adjacent parcels when feasible.
  - \* Require a 40-foot setback from the curb for the first parking stall, or first aisle, to provide a waiting space (queuing) for vehicles leaving and entering lot.

*Intent: To provide safety and easy circulation for both pedestrian and vehicle.*

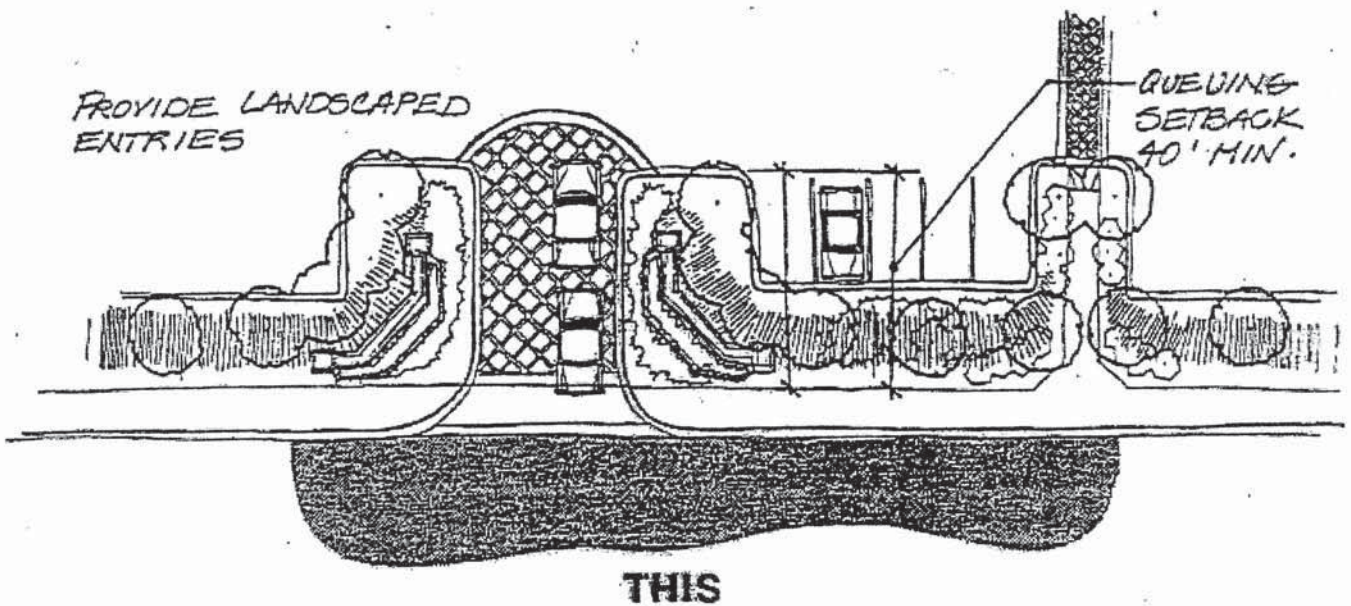

9. Screening: Provide landscape screening to parking lots.
- \* Shrub areas between major streets and parking lots
  - \* Grade differential between public street and parking lots
  - \* Low wall (3' 6" maximum height) with landscaping

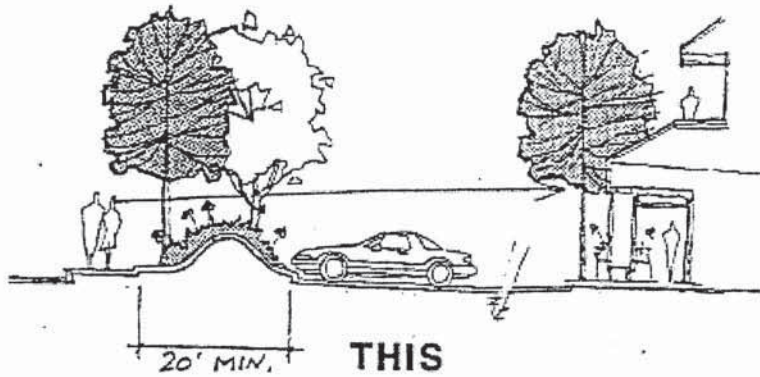

*PARKING LOTS SHOULD  
SETBACK 20 FEET (MIN.)  
AND PROVIDE SCREENING  
WITH LANDSCAPING OR  
BERMS*

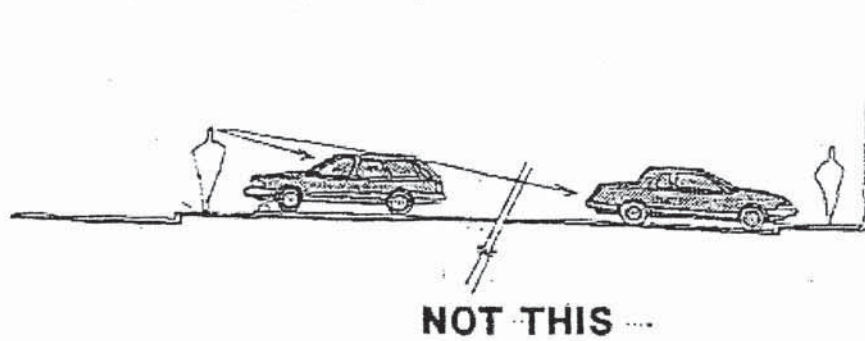

**B. Architectural Guidelines**

The town of Salida is currently a mix of architectural styles. The town history denotes that a small agricultural theme is appropriate. The following architectural guidelines will help maintain and emphasize the agricultural vernacular in the nonresidential areas:

1. Desirable Elements:

- \* Richness and texture (see Materials Guide, page 1-90)
- \* Significant wall articulation and interest (insets, jogs, canopies, etc.)
- \* Distinctive massing (barn, western false fronts, multi-level, multi-planed pitched roofs)
- \* Wide roof overhangs
- \* Distinctive entries
- \* Shingled awnings or canopies

2. Undesirable Elements:

- \* Highly reflective surfaces
- \* Large, blank, unarticulated wall surfaces
- \* Unpainted concrete block
- \* Extensive flat roofs
- \* Unarticulated roof lines and parapets
- \* Irregular or contemporary window shapes
- \* Shingled awnings/canopies



STORE FRONTS

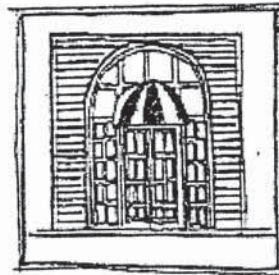
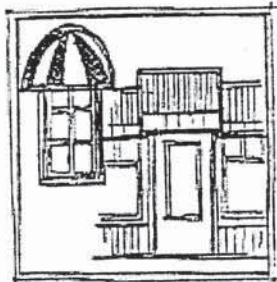

ENTRIES

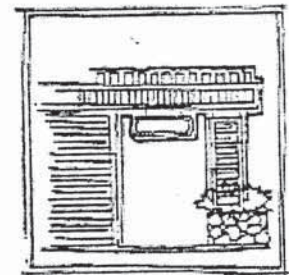

PEDESTRIAN SPACE

3. Appropriate Materials:

- \* Stucco (smooth finishes)
- \* Wood as primary and accent
- \* Brick as primary and accent
- \* River rock as primary and accent
- \* Unglazed tile as accent or roofing material
- \* Split-face masonry block
- \* Cloth/canvas awnings

4. Inappropriate Materials:

- \* Large uniform expanses of metal or aluminum siding
- \* Log cabin look
- \* Unfinished concrete block /unfinished concrete tilt-up
- \* Painted or white brick
- \* Prefab metal structures
- \* Lava rock facades

5. Height and Scale: Height and scale of new development should relate to surrounding development. New development should provide transition in height and scale to adjacent development.

6. Color-Dominant/Accents:

- \* **Dominant Color:** Use earth tone colors for the dominant building color.
- \* **Accent Color:** Highlight the dominant color with accent colors to provide contrast or harmony with dominant colors.

Refer to page 1-75.

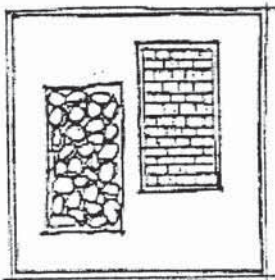

STONE AND BRICK

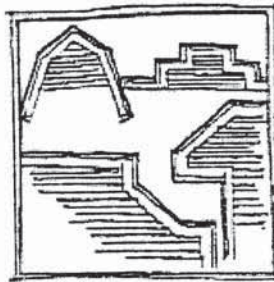

ROOF LINES



BALCONIES

**SALIDA DESIGN GUIDELINES**

***Nonresidential District***

- 7. Solid to Void: Main (front, main building entry) facade construction should be at least 30% transparent. Avoid blank or solid end walls that are visible from public view. Provide elements such as awnings, cornice bands, arcades, trellises, etc., to avoid blank or solid walls which are visible from off site.
  
- 8. Roofs: Flat or sloped roofs are acceptable while partial mansard roofs are not. Design roof form to work with the building mass and facade to produce a consistent and integrated composition. Roof design should conceal rooftop equipment.



*POSSIBLE USE OF TEXTURE,  
RELIEF, ARTICULATION  
(WALL AND ROOF)*

**THIS**

*100% SOLID  
NO TEXTURE  
NO RELIEF  
NO ROOF, WALL  
ARTICULATION*

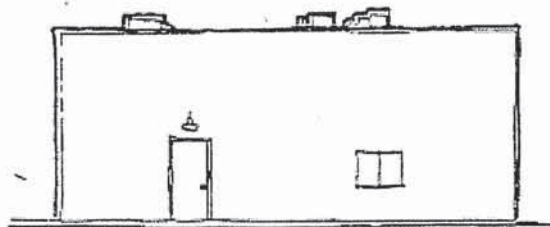

**NOT THIS**

**C. Streets**

Improvement to streets in the nonresidential districts of Salida should increase convenience and safety and provide alternatives to existing primary routes (Broadway).

Special attention should be given to "Old" Highway 99 (Salida Boulevard). Because of its proximity to the "New" Highway 99, the ROW of "Old" Highway 99 holds the potential for commercial, retail, and service development. Improved traffic circulation will increase development opportunities within this area.



**III. RESIDENTIAL**

The residential portion of the redevelopment area consists of two major eras of homes. Residential Area A consists mostly of homes built in the early 1900's and the other (Residential Area B), includes homes that were built in the 1960's (see area map, page 1-58). The condition of houses varies from good to deteriorating and abandoned. The residential neighborhoods of Salida should provide adequate housing and satisfactory quality of life for people of all ages, incomes, and social backgrounds, while maintaining the "small town" scale and style.

The following guidelines address these residential neighborhood areas. These guidelines are more generalized than the "Downtown Commercial District" and the "Nonresidential District" guidelines. The guidelines' intent is to direct new infill development, as well as the renovation of existing housing stock in a way that preserves and enriches Salida's "small town" character and maintains the character of the two eras in which the majority of the homes were built.

The guidelines also address concerns over how the newer residential neighborhoods interface with the older residential neighborhoods. Currently, there are residential subdivisions being built adjacent to the established residential neighborhoods that have incorporated +6-foot solid perimeter walls with homes that turn their back to the street. By doing so, isolated enclaves of neighborhoods are created that do not visually or functionally relate. These guidelines will encourage neighborhood designs that provide visual, pedestrian, and vehicular links.



EXAMPLE OF EARLY 1900'S HOME

*Goal: Improve the appearance and condition of the existing housing stock and neighborhoods to provide housing for a variety of income groups, safety for residents, a sense of neighborhood, and area rejuvenation.*

**A. Site Planning Guidelines**

1. **Setbacks:** Each housing unit should vary in setback (approximately 10%), yet maintain enough street setback to prevent crowding the street. Encourage traditional side lot setbacks. Discourage zero lot lines.

*Intent: Discourage house siting that conflicts with the existing neighborhood character.*

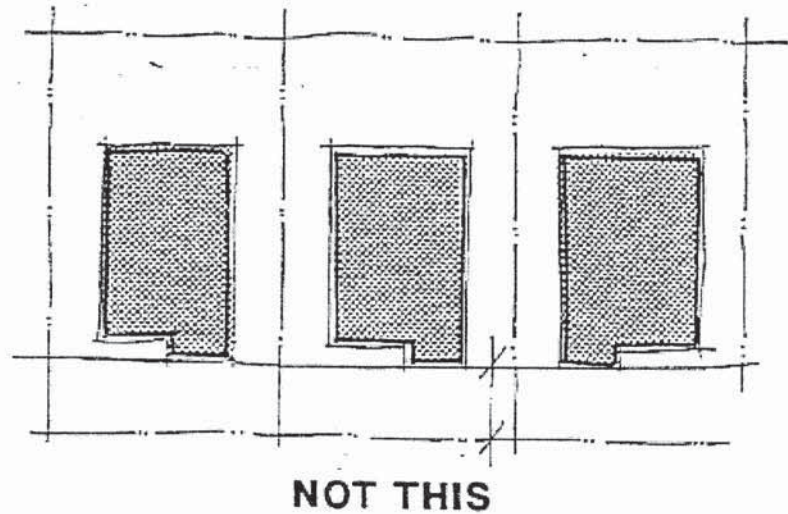
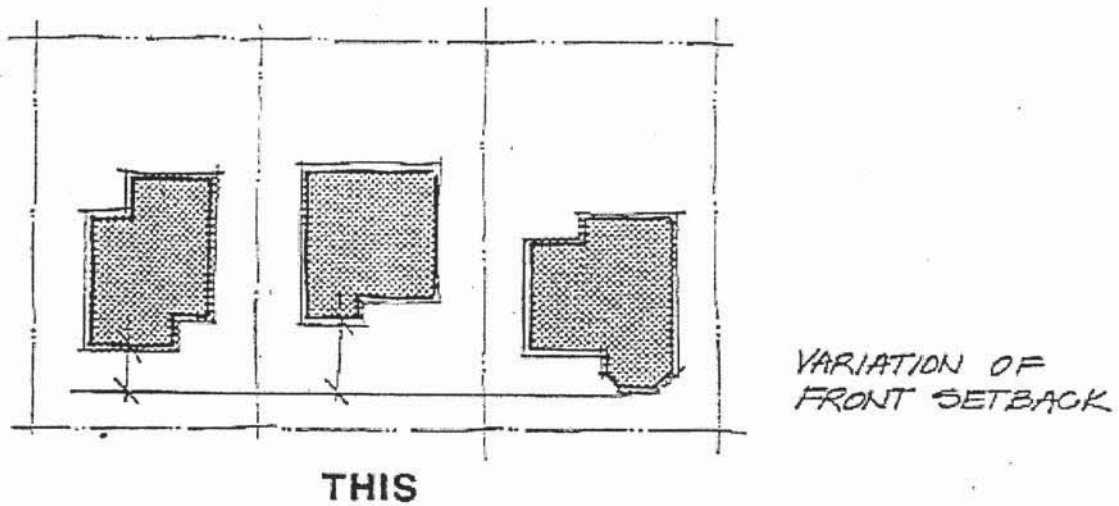

2. Driveway Frontage: Driveway openings may occupy no more than 25% or 18 feet of the lot's total street frontage, whichever is less. However, in no case should a driveway opening be less than 10 feet.

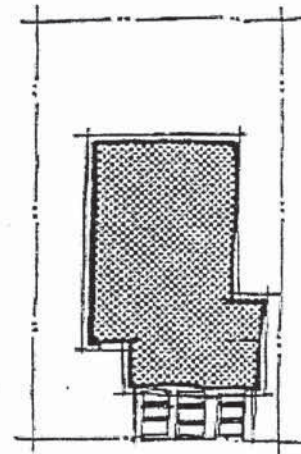
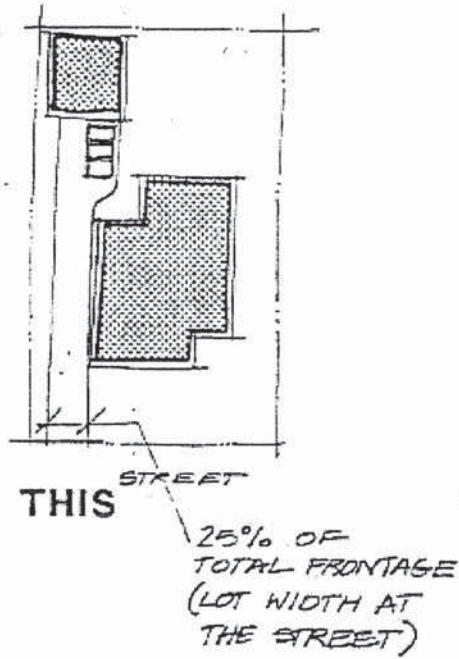

NOT THIS

3. Infill Housing: Develop vacant lots with a variety of new housing types to meet the various housing demands of the community.

\* Relate residential infill development to the surrounding neighborhood.

*Intent: Encourage infill housing which would provide quality housing for people from a variety of income and social groups and be compatible with surrounding housing.*

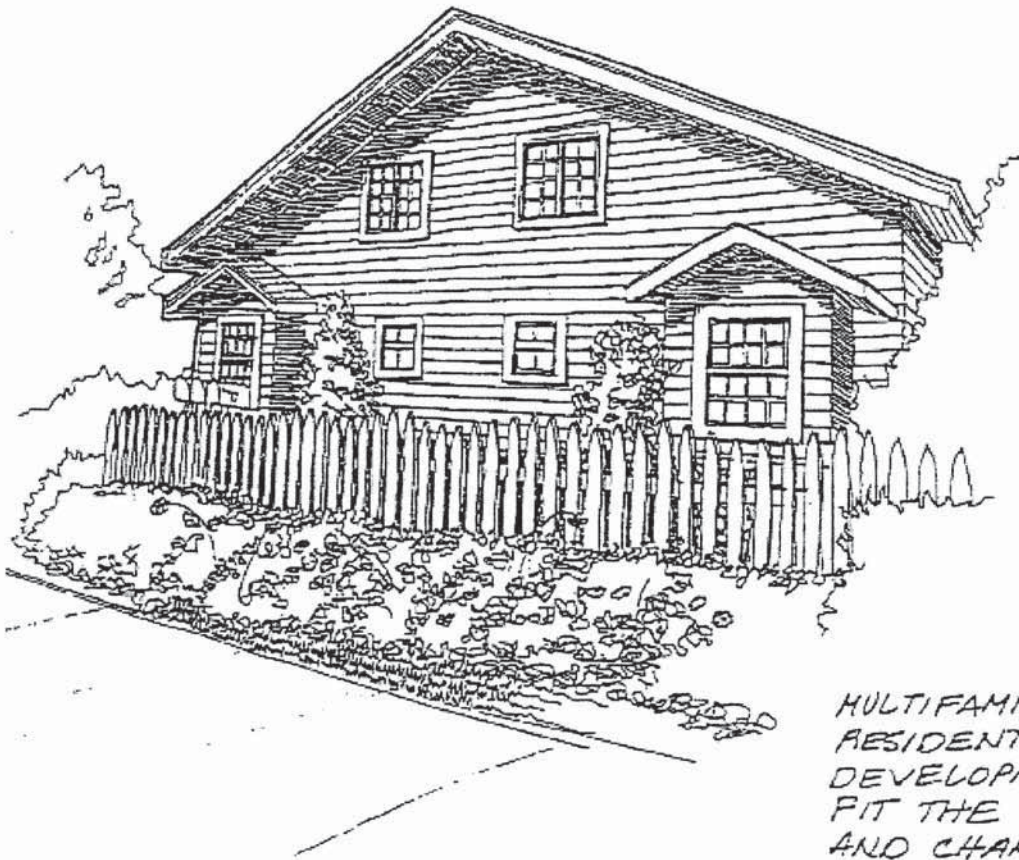

MULTIFAMILY  
RESIDENTIAL  
DEVELOPMENT TO  
FIT THE SCALE  
AND CHARACTER  
OF THE RESIDENTIAL  
NEIGHBORHOOD  
(AREA A).

**B. Landscaping**

1. **Fencing:** Proper front yard fencing is an important part of maintaining the neighborhood's image and ensuring defensible space for safety. Limit fencing to simple picket fences and low garden walls.
  - \* Define public and private space with landscaping and low garden walls or fences at the inside edge of the sidewalk.
  - \* Discourage front yard perimeter fences and walls and chainlink fences that act as visual barriers in front yards.
  
2. **Street Trees:** Encourage street trees in existing residential neighborhoods and new developments. Plant trees every 30 feet (15 gallon minimum).

*Intent: Provide a shady canopy in residential neighborhoods and create pedestrian scale along residential streets.*

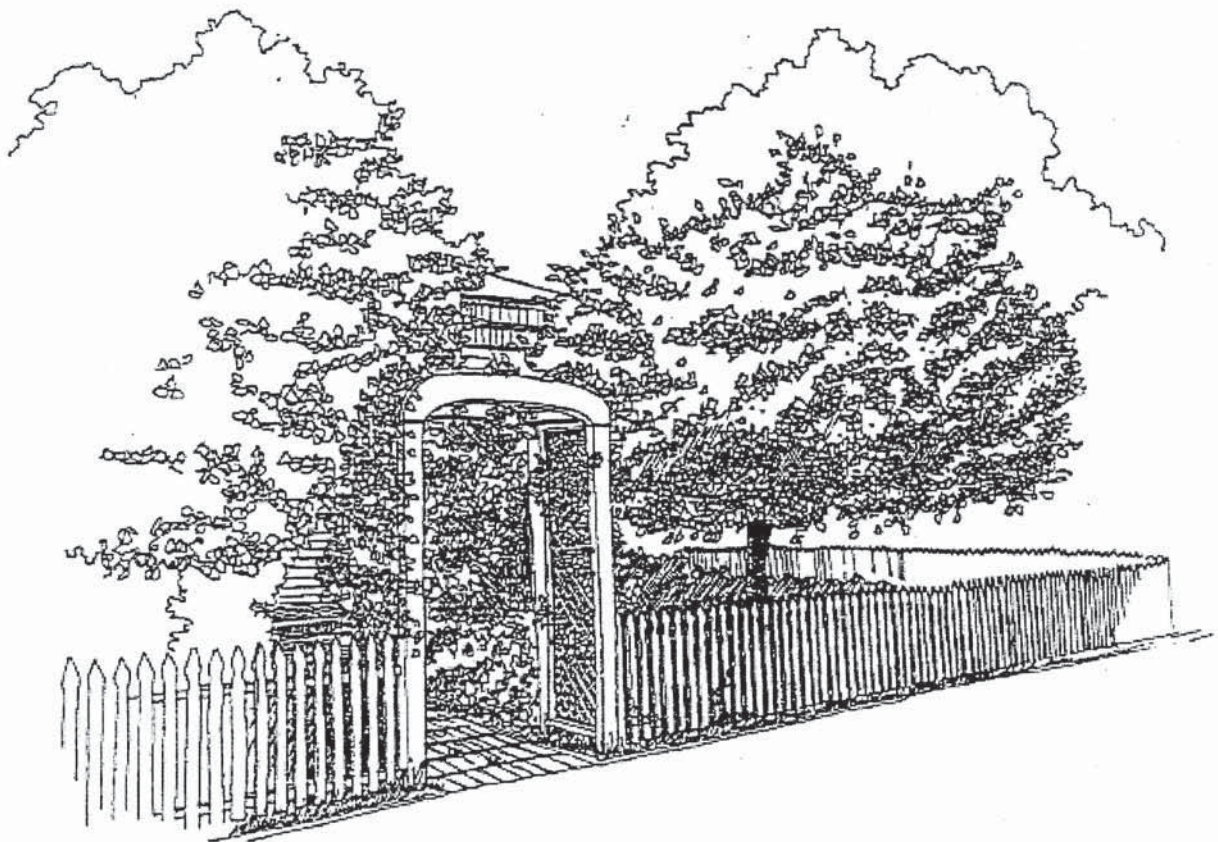

**C. Architectural Guidelines**

1. Renovation: Improve the condition of existing neighborhood housing that is in poor condition.
  - \* Preserve, whenever possible, existing structures which display desirable character. Renovation, remodeling, and improvements should respect and enhance any established neighborhood character.
  
2. Traditional Design Elements: Homes built in the early 1900's lack typical design elements such as porches, low walls, and picket fences at the sidewalk's edge and garages and carports to rear of the property, as well as other traditional residential features (see page 1-99). Homes built in the 1960's were auto-oriented and had a different look, such as garages facing the front and ranch style layout (see page 1-100).

Efforts to maintain the character of these two sub areas of homes should be made by respecting the predominant agricultural character of each of the existing homes in these areas.

*Intent: Preserve existing neighborhood character and protect "small town" image.*

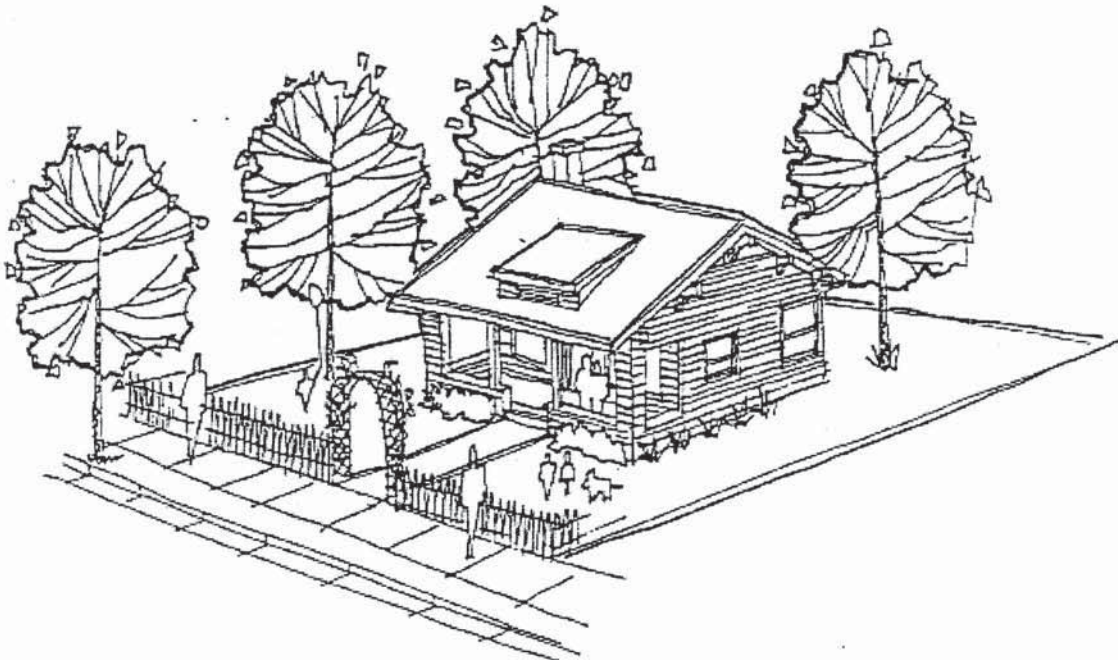

- 3. Height and Scale: Height and scale of homes should reflect the established pattern in the existing neighborhood.
- 4. Materials: Materials consisting of simple lap siding, brick, river rock, and smooth stucco are common and reflect the proper image of the neighborhood. Materials used should be consistent with adjacent homes.

*Intent: Encourage new and remodeled houses and apartments to use materials which characterize the immediate neighborhood.*

- 5. Doors and Windows: Doors and windows should reflect the neighborhood's era. Features like multi-paned glass, greater vertical proportions than width windows, glass doors, window shutters, and cloth awnings are desirable.

*Intent: Preserve a continuity between existing historical structures and new buildings.*

Refer to page 1-72.

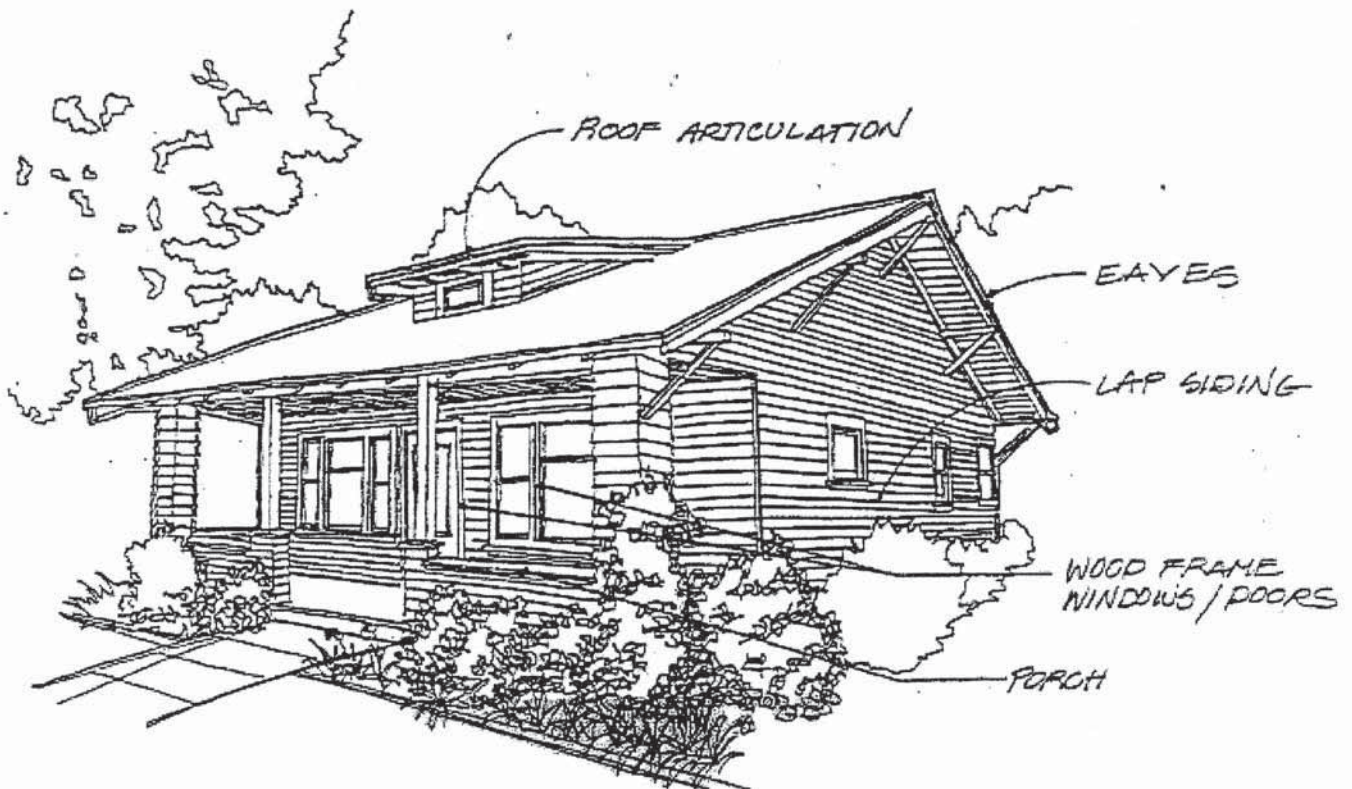

**Design Elements of a Residence Within Area A**

6. Roofs: Simplify roofs with low pitches and overhangs. Roof materials should consist of simple asphalt shingles or Spanish tiles. Flat roofs hidden by extended facades are also appropriate.
  
7. Garages: Early American homes lack garage-dominated streetscapes (Area A). Encourage alley access where possible. Elsewhere, minimize visual impact of garage doors and driveways by placing garages to the rear of the residence and minimizing driveway width. In Residential Area A, existing garage doors face to street; where possible, the garage doors can be turned perpendicular to the street to minimize the visual impact of the door.

*Intent: Preserve traditional neighborhood character by minimizing the automobile's visual impact.*

8. Color: Refer to page 1-75.



**Design Elements of a Residence Within Area B**



**D. Streets and Alleys**

Existing streets and alleys in the residential zone lack differentiation, adequate paving (drainage), lighting, and marking (and in many areas, sidewalks). Pursue Public Work's projects with redevelopment funding and Community Development Block Grant (CDBG) funds to provide improved streets, curbs, gutters, and sidewalks.

*Intent: Provide streets and alleys which are safe and functional, while maintaining the neighborhood's rural character.*

- 1. Residential Streets: Resurface and improve signage and lighting on existing streets.

*Intent: Provide safe and legible roadways for drivers and pedestrians.*

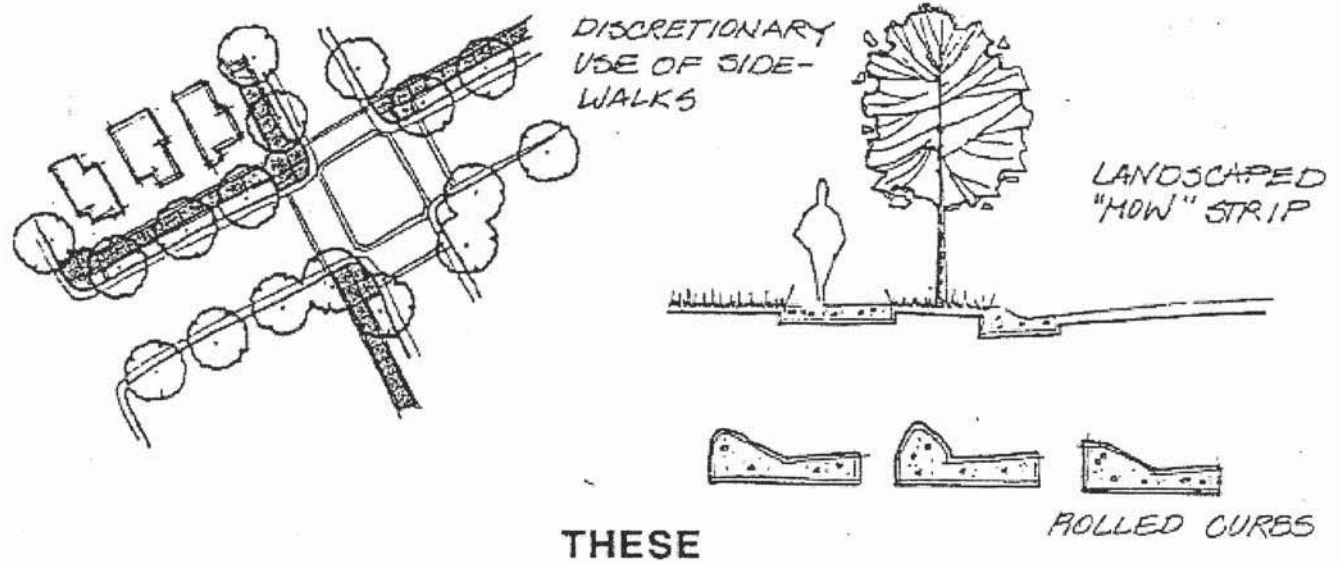

2. Sidewalks: Provide curbs, gutters, and sidewalks in a manner which maintains a "small town" character, while providing for pedestrian paths, road edges, and drainage.

\* Encourage the use of rolled curbs, straight, narrow sidewalks, and planted parkways.

*Intent: Preserve the neighborhood's character and prevent the larger scale urban look occurring in newer housing developments.*

Refer to page 1-64.

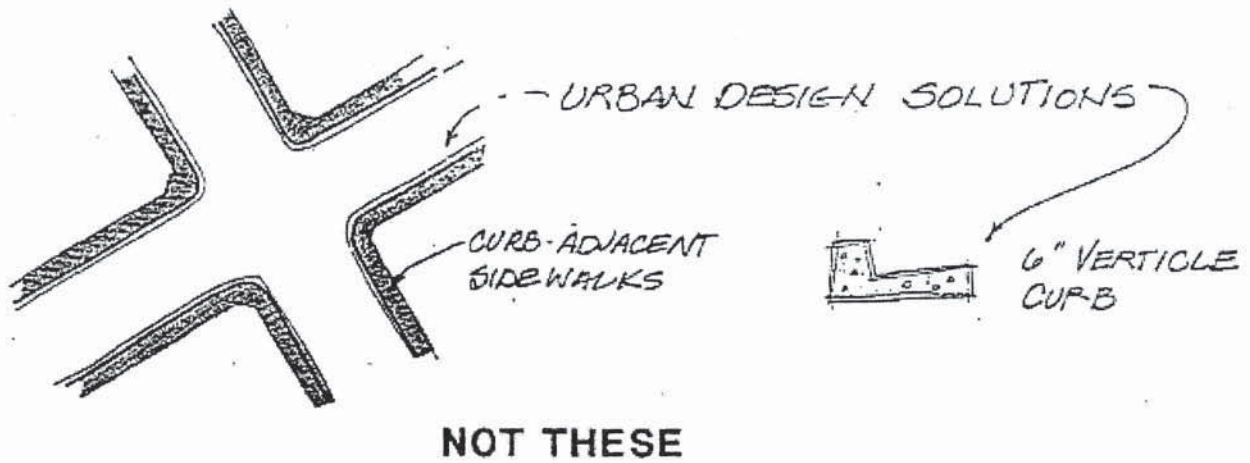

- 3. Alleys: Alleys are a desirable feature. Use them to their full potential. Place garages, carports, utilities, and solid waste storage areas in the alleys.

- \* Differentiate alleys from streets to discourage through traffic and promote a more logical neighborhood circulation pattern.

*Intent: Minimize visual impact of garages, cars, utilities, and garbage cans on streets.*

- 4. Parking: Limit parking of vehicles to driveways, garages, and street frontages. Avoid parking in front yard areas.

*Intent: Discourage clutter of automobiles throughout neighborhoods.*

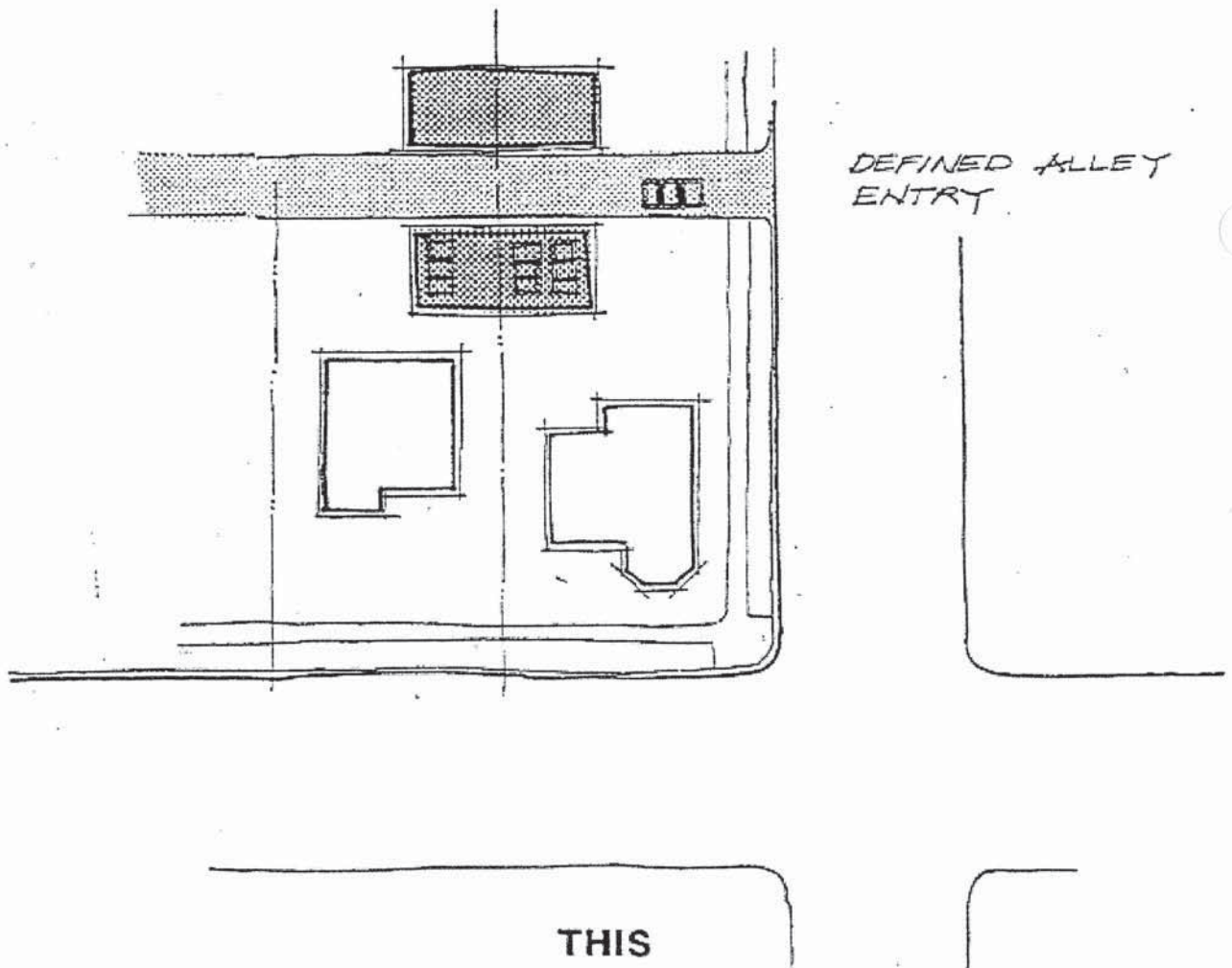

## IV. PARKS

Based upon the community survey results, Salida's major downtown park has become an unfriendly, unsafe place not suitable for families and children. Park improvements can create an improved environment that people will enjoy. A park facility redesign effort should be pursued. Expansion of the park into a system of parks will further serve to enhance the safety and desirability of the park while providing important linkages throughout the community.

*Goal: Promote overall community vitality and participation which enhance the "small town" character and offer safe recreation for all Salida residents and children.*

## A. Site Planning Guidelines

1. Visibility: Eliminate areas of low visibility behind buildings, barriers, and landscaping. Maximizing visibility of all areas from the street.

*Intent: Discourage vagrancy and crime to increase safety for park goers.*

2. Pocket Parks: Develop a system of neighborhood pocket parks on empty lots within the neighborhoods. Link all parks with the large park.

*Intent: Provide small local play lots.*

3. Park Facilities: Redesign restrooms and park facilities to minimize the potential for crime and to maximize policing.

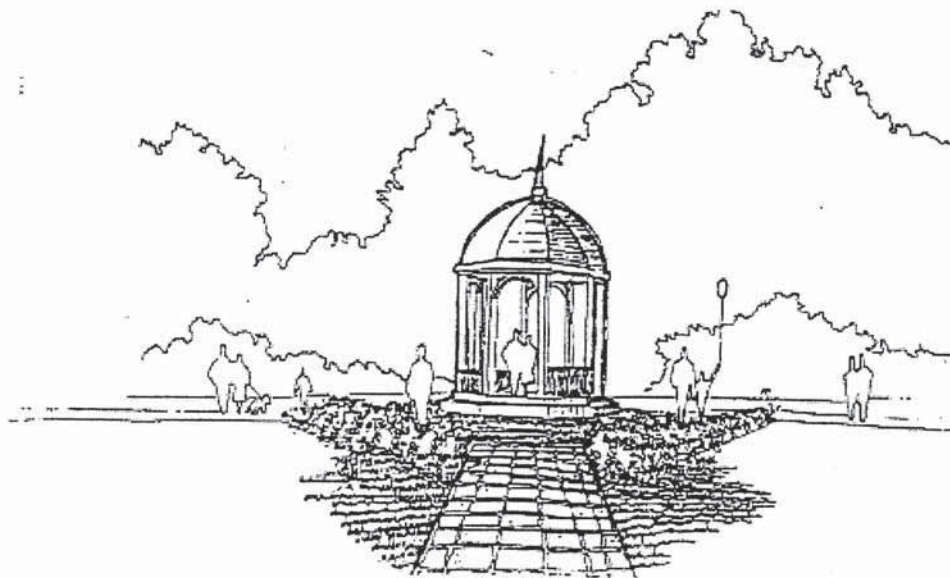

- 4. Parks as Nodes: The park should serve as a central node with good linkages to neighborhoods and downtown. Streetscape and street improvements in both the commercial and residential areas should reinforce the concept of linkages and paths to the park.

*Intent: Make the park easily accessible by foot and an important central open space element of the downtown.*

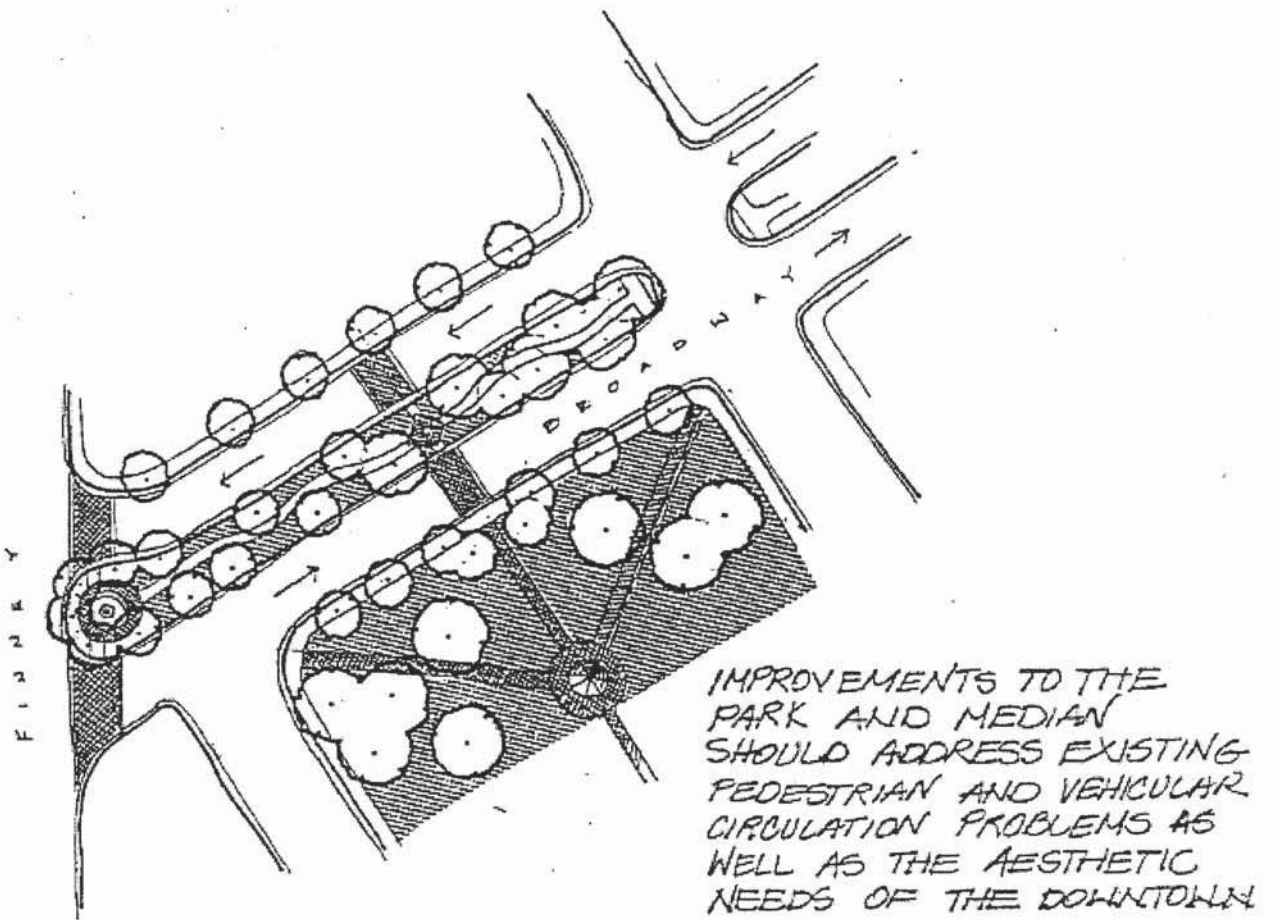

## V. GENERAL NEIGHBORHOOD CLEANUP

The old neighborhoods of Salida contain many instances of abandoned cars, junk in yards, weeds, overgrown trees, and trash in empty lots creating a rundown appearance, as well as potentially dangerous conditions. The community should be encouraged to get involved in community cleanup through a "Community Beautification Program". This type of program typically involves a lead committee (perhaps the MAC), which organizes efforts that will involve the citizens of Salida in massive volunteer cleanup efforts. These efforts not only result in cleanup, but will also build community pride.

*Goal: Improve the visual appearance of Salida's neighborhoods.*

The following guidelines address four neighborhood cleanup issues which can be addressed through a community-wide cleanup campaign resulting in an improved visual appearance.

### A. Guidelines

1. Cars and Trucks: Remove abandoned vehicles and reduce car repair in yards and on streets.
2. Rubbish: Remove junk and trash (auto parts, refrigerators, furniture, etc.), from private property and empty lots.
3. Trees: Properly maintain street trees and remove weeds from around houses and empty lots.
4. Vacant Lots: Encourage the "recycling" of vacant lots into new housing or neighborhood parks.

## VI. IMPLEMENTATION AND INTERPRETATION OF GUIDELINES

These Design Guidelines are intended to be directive, not mandatory and should be applied within the context of the County of Stanislaus General Plan and Zoning. Graphics are intended to convey ideas and concepts, not to be taken literally. It shall be the responsibility and authority of the Stanislaus County Planning Director/Redevelopment Agency staff or his duly appointed representative to interpret and apply these guidelines. Where dispute may arise, appeal procedures pursuant to the Stanislaus County Zoning Ordinance are available for remedy.

**GLOSSARY**

<b>Articulation</b>	Horizontal and vertical variations in the surface plane of a structure. For example: A cube has no articulation; by adding and subtracting vertical and horizontal elements to the cube, (articulation), a more interesting shape is created (see illustration on page 1-84).
<b>Awnings</b>	Cloth-covered door and window overhangs which provide shade and shelter. Usually colorful, can be embellished with signs and have a variety of shapes.
<b>Buffer Zone</b>	A strip of land which protects one land use from another. For example: Landscaped buffers with earth berms and low walls are excellent at "buffering" parking lots from adjacent uses.
<b>Building Facades</b>	The side of the building facing the street. Typically, the front of the building.
<b>Canopies</b>	Structural projections from buildings designed to provide shelter and define pedestrian space on the sidewalk.
<b>Community Fringes</b>	The areas of new growth directly adjacent to the existing developed Community of Salida, particularly those areas outside of the redevelopment plan boundaries.
<b>Community Revitalization</b>	The goal of bringing new development, while renovating, restoring, and renewing existing development in Salida in order to improve economic function and quality of life.
<b>Continuous Edge</b>	Alignment of buildings, low walls, and fences along a street or sidewalk which creates an uninterrupted linear edge.
<b>Curb Adjacent</b>	Refers to a sidewalk's position directly against the curb. Often typical of downtown areas, but not preferable in residential areas.
<b>Districts</b>	An area of homogeneous characteristics (e.g., structures, uses, etc.), that distinguishes it from another area. For example: Salida's downtown "district" is different than the residential "district".

**GLOSSARY** (continued)

<b>False Front</b>	An architectural treatment of the front of a building that masks the structural form and material of the building.
<b>Graphic/Icon Signs</b>	Signs which use symbols rather than words to advertise a message. For example: A barber pole is an icon sign; another example could be an ice cream cone graphic to advertise an ice cream store. Icon signs are especially well suited as pedestrian signs (page 1-74).
<b>Human Scale</b>	The perceived size of a building or space defined in terms of its relationship to the size of a person. A building or space of a human scale will be proportioned in such a way that it is comfortable, desirable, and pleasing to people.
<b>Recessed Entries</b>	A space off the sidewalk that allows for opening doors and window shopping and increases facade variation.
<b>Right-of-Way (R.O.W.)</b>	The width of land set aside for streets, sidewalks, and landscaping. Generally, development does not occur within the R.O.W.
<b>Rhythm</b>	The pattern of form created by a series of buildings with related character, width, and scale.
<b>Scale</b>	The size of a structure as perceived by the eye. The same size building can reduce its scale by adding detail, articulation, overhangs, and landscaping (see articulation).
<b>Setback</b>	The distance between a structure and the lot lines (property lines), sometimes referred to as "yards". Typically setbacks are specified for front yards, rear yards, and side yards.
<b>Shingled Canopies</b>	Shed, roof-like canopies projecting from buildings with wood shingles.
<b>Streetscape</b>	Elements of a street that improve the pedestrian experience and vehicular circulation. For example: Street trees, curbs and sidewalks, clear signage, street lighting, street furniture, and crosswalks (see pedestrian environment).
<b>Vertical</b>	Zoning which allows for different uses at different elevations in the same building. For example: Commercial uses limited to the first floor and residential uses limited to the second and third floors would constitute vertical zoning (see mixed uses).



**APPENDIX**

# HAVE A SAY IN SALIDA'S FUTURE

Salida has been chosen to receive funds which will be used to help improve the quality of your community. We are interested in knowing what you think about your community and what you would like to see happen in the future. Please take a few minutes to share your thoughts with us by completing this survey. Your participation is essential!!

1. PLEASE RATE THE IMPORTANCE OF EACH OF THE FOLLOWING: (Circle one)

	Very Important	Moderately Important	Not Important	No Opinion
A. Street and curb improvements	1	2	3	4
B. Uniform architectural style				
1. In residential areas	1	2	3	4
2. In commercial areas	1	2	3	4
C. Public restrooms	1	2	3	4
D. "Small town" character	1	2	3	4
E. Landscaping	1	2	3	4
F. Bicycle paths	1	2	3	4
G. Economic/commercial growth	1	2	3	4
H. Parking	1	2	3	4
I. Street lighting	1	2	3	4
J. Pedestrian circulation	1	2	3	4
K. Improved store fronts	1	2	3	4
L. Parks	1	2	3	4
M. Downtown	1	2	3	4
N. Street furniture	1	2	3	4
O. Public utility improvements	1	2	3	4
P. Salida's town history	1	2	3	4
Q. Other _____	1	2	3	4

2. OF THE ABOVE ITEMS, WHICH FIVE DO YOU THINK ARE THE MOST IMPORTANT? (Identify by letter)

1. \_\_\_\_\_ 2. \_\_\_\_\_ 3. \_\_\_\_\_ 4. \_\_\_\_\_ 5. \_\_\_\_\_

3. PLEASE LIST THREE THINGS ABOUT YOUR COMMUNITY THAT YOU THINK NEED IMPROVEMENT:

1. \_\_\_\_\_
2. \_\_\_\_\_
3. \_\_\_\_\_

4. DO YOU LIKE THE VISUAL APPEARANCE OF: (Circle one)

A. Older residential neighborhoods	Yes	No	No opinion
B. Newer residential neighborhoods	Yes	No	No opinion
C. Older business areas	Yes	No	No opinion
D. Newer business areas	Yes	No	No opinion

5. PLEASE PROVIDE ANY OTHER COMMENTS YOU MAY HAVE THAT WILL HELP US UNDERSTAND YOUR DESIRES FOR THE FUTURE OF SALIDA.

\_\_\_\_\_

\_\_\_\_\_

\_\_\_\_\_

6. ARE YOU A RESIDENT OF SALIDA? (Circle one)      Yes                  No

UPON COMPLETION OF THIS SURVEY, PLEASE DEPOSIT IT IN ONE OF THE MARKED BOXES OR RETURN NO LATER THAN AUGUST 29, 1990 TO: STANISLAUS COUNTY, MUNICIPAL ADVISORY COUNCIL, P.O. Box 374, SALIDA, CALIFORNIA 95368.

# Summary of Responses to:

## HAVE A SAY IN SALIDA'S FUTURE

Salida has been chosen to receive funds which will be used to help improve the quality of your community. We are interested in knowing what you think about your community and what you would like to see happen in the future. Please take a few minutes to share your thoughts with us by completing this survey. Your participation is essential!

1. PLEASE RATE THE IMPORTANCE OF EACH OF THE FOLLOWING: (Circle one)  
 Categories with an \* are identified as "most important" in question number 2; bold percentages indicate greatest response (mode).

		Very Important	Moderately Important	Not Important	No Opinion
*A.	Street and curb improvements	72.2%	24.1%	2.8%	1.0%
B.	Uniform architectural style				
	1. In residential areas	21.2%	28.8%	<b>40.4%</b>	9.6%
	2. In commercial areas	29.8%	<b>31.9%</b>	30.9%	7.4%
C.	Public restrooms	30.7%	<b>34.7%</b>	30.7%	4.0%
*D.	"Small town" character	<b>58.7%</b>	25.0%	11.5%	4.8%
E.	Landscaping	<b>57.0%</b>	30.8%	10.3%	1.9%
F.	Bicycle paths	<b>42.7%</b>	34.0%	20.4%	2.9%
G.	Economic/commercial growth	<b>43.3%</b>	34.6%	17.3%	4.8%
H.	Parking	<b>46.2%</b>	43.3%	9.6%	1.0%
*I.	Street lighting	<b>68.9%</b>	26.4%	3.8%	0.9%
J.	Pedestrian circulation	<b>47.1%</b>	32.4%	9.8%	10.8%
K.	Improved store fronts	<b>52.8%</b>	35.8%	9.4%	1.9%
*L.	Parks	<b>66.3%</b>	26.0%	6.7%	1.0%
*M.	Downtown	<b>65.4%</b>	19.6%	10.3%	4.7%
N.	Street furniture	20.8%	32.1%	<b>38.7%</b>	8.5%
O.	Public utility improvements	37.7%	<b>42.5%</b>	8.5%	11.3%
P.	Salida's town history	<b>43.7%</b>	32.0%	15.5%	8.7%
Q.	Other				

2. OF THE ABOVE ITEMS, WHICH FIVE DO YOU THINK ARE THE MOST IMPORTANT? (Identify by letter)

1. (A) 14.4%    2. (I) 11.4%    3. (L) 8.7%    4. (M) 8.7%    5. (D) 7.2%

3. PLEASE LIST THREE THINGS ABOUT YOUR COMMUNITY THAT YOU THINK NEED IMPROVEMENT:

1. Police Protection (own police department; faster response times)
  2. Sidewalks/street improvements (Broadway & major streets, bike paths, curbs & gutters)
  3. General clean-up (housing, streets, junk, weeds, removal of abandoned cars)
- Also mentioned often: Park safety, landscaping, street lighting*

4. DO YOU LIKE THE VISUAL APPEARANCE OF: (Circle one)

	Yes	No	No Opinion
A. Older residential neighborhoods	25.5%	<b>63.3%</b>	11.2%
B. Newer residential neighborhoods	<b>84.6%</b>	7.8%	7.8%
C. Older business areas	31.7%	<b>60.4%</b>	7.9%
D. Newer business areas	<b>81.0%</b>	7.0%	12.0%

5. PLEASE PROVIDE ANY OTHER COMMENTS YOU MAY HAVE THAT WILL HELP US UNDERSTAND YOUR DESIRES FOR THE FUTURE OF SALIDA.

1. General cleanup
2. Parks not suitable for families
3. Police protection

*Also Mentioned often: Growth management, landscaping, sidewalk and street improvements, drunkenness/loitering*

6. ARE YOU A RESIDENT OF SALIDA? (Circle one)    Yes **82.4%**    No 17.6%

UPON COMPLETION OF THIS SURVEY, PLEASE DEPOSIT IT IN ONE OF THE MARKED BOXES OR RETURN NO LATER THAN AUGUST 29, 1990 TO: STANISLAUS COUNTY, MUNICIPAL ADVISORY COUNCIL, PO BOX 374, SALIDA, CA 95368. IF YOU HAVE ANY QUESTIONS OR WOULD LIKE ADDITIONAL INFORMATION, PLEASE CONTACT: GARY DEW (209) 545-0205.

**SOURCES**

Claire Associates, Inc., 1990, Preliminary Redevelopment Plan for Stanislaus County Redevelopment Project No. 1.

Claire Associates, Inc., 1990, Draft Redevelopment and Housing Needs Assessment and Community Redevelopment Plan for Stanislaus County and the Salida Community.

Habe, Reiko, Design Guidelines and Community Character Compatibility

John B. Dykstra & Associates, 1989, Stanislaus County Redevelopment Feasibility Assessment.

RRM Design Group, 1990, Have a Say in Salida's Future: (community survey questionnaire).

## **Appendix I-C**

# **PLANNED DEVELOPMENT AREA SPECIFIC RESOLUTIONS**

1. RESOLUTION NO. 87-1 – UPPER MCHENRY
2. RESOLUTION NO. 87-3 – FREEWAY INTERCHANGE AND  
FRONTAGE ROADS

***THIS PAGE INTENTIONALLY LEFT BLANK***

APPENDIX I-1

RESOLUTION NO. 87-1

RESOLUTION OF THE STANISLAUS COUNTY PLANNING COMMISSION AMENDING DEVELOPMENT POLICIES WITH RESPECT TO THE REVIEW AND APPROVAL OF PLANNED DEVELOPMENT APPLICATION ON UPPER MCHENRY AVENUE.

WHEREAS, the proper regulation of development along McHenry has been the subject of concern to the City of Modesto and the County of Stanislaus for a long period of time, and

WHEREAS, the Stanislaus County Board of Supervisors, on the recommendation of the County Planning Commission, amended the Land Use Element of the Stanislaus County General Plan to designate the upper McHenry frontages for "Planned Development", and

WHEREAS, it is consistent with the "Planned Development" designation to establish development policies which will serve as guidelines for property owners and the County in the formulation and review of specific development proposals, and

WHEREAS, the Stanislaus County Planning Commission adopted Resolution No. 74-1 on April 11, 1974 to establish said policies.

NOW, THEREFORE, BE IT RESOLVED that the following policies are hereby established by the Stanislaus County Planning Commission with respect to the development of the "Planned Development" designations on upper McHenry Avenue.

Precise plans should be adopted to provide for two collector streets to cross McHenry at one-quarter mile intervals between Pelandale Avenue and Kiernan Avenue.

No planned development application should be approved which would conflict with the above mentioned precise plans or with the adopted Pelandale Avenue precise plan.

All planned development approvals shall provide for establishment of access driveways at intervals no closer than 200 feet where possible and on-site accessways (customer-front; freight-rear) shall be provided as approved.

Shopping centers should be permitted only at the McHenry Avenue-Pelandale Avenue and McHenry Avenue-Kiernan Avenue intersections.

Planned development approval on properties which are no on the intersections noted above should be limited to uses with a demonstrated history of lower traffic generation.

The "Planned Development" designation which has been applied to upper McHenry Avenue should not be interpreted to allow non-residential uses to project easterly or westerly from the

McHenry frontage to the extent that they could initially or potentially diminish the agricultural or residential usage of lands in the immediate area. With the exception of the shopping centers at the corners listed above, the following depths are hereby established:

- A. From Modesto Irrigation District Lateral No. 6 north - 450 feet from the centerline of McHenry Avenue.
- B. From the Modesto City Limits north to Lateral No. 6 on the east side of McHenry Avenue - 488 feet from the centerline of McHenry Avenue.
- C. From the Modesto City Limits north to Lateral No. 6 on the west side of McHenry Avenue - the westerly property lines of the existing parcels.

Planned development applications on upper McHenry Avenue should include provisions for the ultimate usage of entire contiguous ownerships. However, the application may provide for the phasing of development.

All non-residential planned development approvals shall include as an exhibit thereto, a signed agreement in a form satisfactory to the Modesto City Attorney and Stanislaus County Counsel guaranteeing that the property on which the planned development is applicable will be annexed to the City of Modesto and/or connected to the Modesto public sewer system when such annexation or sewer connection is demanded by the City of Modesto with the approval of the Stanislaus County Board of Supervisors.

All residential planned development approvals shall include provisions for annexation to the City of Modesto prior to occupancy thereof.

All planned development applications should provide for consistence with City of Modesto and County of Stanislaus standards with respect to landscaping, off-street parking, sign control and street improvements.

The Planning Commission should review all divisions of land within the planned development designation to insure that such divisions are consistent with the above policies and approved land uses.

PASSED AND ADOPTED this 21st day of May, 1987 on motion of Commissioner Parks, seconded by Commissioner Steinpress, by the following vote:

AYES: Coe, Entin, Graham, Hertle, Parks, Rettig, Steinpress,  
Wikoff  
NOES: None  
ABSTAIN: Stephens

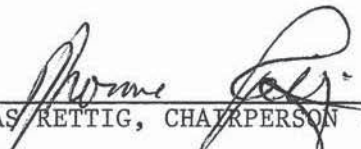
  
THOMAS RETTIG, CHAIRPERSON



APPENDIX I-3

RESOLUTION NO. 87-3

RESOLUTION OF THE STANISLAUS COUNTY PLANNING COMMISSION ESTABLISHING DEVELOPMENT POLICIES WITH RESPECT TO THE REVIEW AND APPROVAL OF PLANNED DEVELOPMENT APPLICATIONS AT FREEWAY INTERCHANGES AND ADJACENT FRONTAGE ROADS.

WHEREAS, the proper regulation of development at freeway interchanges and adjacent frontage roads has been the subject of concern to the County of Stanislaus for a long period of time, and

WHEREAS, the Stanislaus County Board of Supervisors, on the recommendation of the County Planning Commission, amended the Land Use Element of the Stanislaus County General Plan to designate these interchanges and frontage road areas, for "Planned Development", and

WHEREAS, it is consistent with the "Planned Development" designation to establish development policies which will serve as guidelines for property owners and the County in the formulation and review of specific development proposals, and

WHEREAS, the Stanislaus County Planning Commission adopted Resolution No. 77-5 on April 14, 1977 to establish said policies.

NOW, THEREFORE, BE IT RESOLVED that the following policies are hereby established by the Stanislaus County Planning Commission with respect to the development of the "Planned Development" designations on freeway interchanges and adjacent frontage roads.

Planned Development Applications for freeway and adjacent frontage roads should be for only those uses that service highway oriented traffic and would not be more properly located in any of the zoning districts existing in the County of Stanislaus or any of the cities within the County.

All planned development applications for adjacent freeway frontage roads should include provision for the ultimate usage of entire contiguous ownerships. However, the application may provide for the phasing of development.

All planned development approvals shall include as an exhibit thereto, a signed agreement in a form satisfactory to the appropriate City Attorney and Stanislaus County Counsel guaranteeing that the property on which the planned development is applicable will be annexed to the appropriate city and/or connected to a public sewer system when such annexation or sewer connection is demanded by said city with the approval of the Stanislaus County Board of Supervisors.

All planned development applications should provide for consistence with County of Stanislaus standards with respect to landscaping, off-street parking, sign control and street improvements.

The Planning Commission should review all divisions of land within the planned development designation to insure that such divisions are consistent with the above policies and approved land uses.

PASSED AND ADOPTED this 21st day of May, 1987 on motion of Commissioner Parks, seconded by Commissioner Steinpress, by the following vote:

AYES: Coe, Entin, Graham, Hertle, Parks, Rettig, Steinpress,  
Wikoff  
NOES: None  
ABSTAIN: Stephens

  
\_\_\_\_\_  
THOMAS RETTIG, CHAIRPERSON

## **Appendix I-D**

# **STANISLAUS COUNTY DISADVANTAGED UNINCORPORATED COMMUNITIES REPORT**

***THIS PAGE INTENTIONALLY LEFT BLANK***

# STANISLAUS COUNTY DISADVANTAGED UNINCORPORATED COMMUNITIES REPORT

**PREPARED FOR:**

Stanislaus County Planning and Community Development  
1010 Tenth Street, Suite 3400  
Modesto, CA 95354  
Contact: Kristin Doud, Associate Planner  
209.565.6330

**PREPARED BY:**

ICF International  
630 K Street, Suite 400  
Sacramento, CA 95814  
Contact: Antero Rivasplata  
916.737.3000

**November 2015**



ICF International. 2015. *Stanislaus County Disadvantaged Unincorporated Communities Report*.  
November. (ICF 00230.10.) Sacramento, CA. Prepared for Stanislaus County, CA.

# Contents

---

List of Tables .....	I-259
List of Figures.....	I-260
List of Acronyms and Abbreviations.....	I-261
<b>Chapter 1 Background and Overview of Statutory Requirements .....</b>	<b>I-262</b>
<b>Chapter 2 Existing Conditions, By Community .....</b>	<b>I-265</b>
2.1 Cowan Tract.....	I-265
2.2 Crows Landing .....	I-278
2.3 Grayson .....	I-291
2.4 Keyes .....	I-304
2.5 Monterey Park Tract.....	I-318
2.6 Riverdale Park Tract .....	I-330
2.7 Westley.....	I-342
<b>Chapter 3 Community Needs Assessment.....</b>	<b>I-355</b>
3.1 Cowan Tract DUC.....	I-355
3.2 Crows Landing DUC .....	I-355
3.3 Grayson DUC .....	I-355
3.4 Keyes DUC .....	I-355
3.5 Monterey Park Tract DUC.....	I-356
3.6 Riverdale Park Tract DUC .....	I-356
3.7 Westley DUC.....	I-356
<b>Chapter 4 Healthy Communities Strategies.....</b>	<b>I-357</b>
4.1 Land Use Element.....	I-357
4.2 Circulation Element .....	I-358
4.3 Additional Policies .....	I-358

## Tables

---

2-1	Cowan Tract Crime Indices .....	I-269
2-2	San Joaquin Valley Air Basin Air Quality Attainment Status .....	I-272
2-3	Stanislaus County Days in Exceedance of State and Federal Air Quality Standards, 2013.....	I-273
2-4	Community Health Assessment of Stanislaus County Geographic Regions .....	I-274
2-5	Crows Landing Crime Indices .....	I-282
2-6	San Joaquin Valley Air Basin Air Quality Attainment Status .....	I-285
2-7	Stanislaus County Days in Exceedance of State and Federal Air Quality Standards, 2013.....	I-286
2-8	Community Health Assessment of Stanislaus County Geographic Regions .....	I-286
2-9	Grayson Crime Indices .....	I-295
2.10	San Joaquin Valley Air Basin Air Quality Attainment Status .....	I-297
2-11	Stanislaus County Days in Exceedance of State and Federal Air Quality Standards, 2013.....	I-298
2-12	Community Health Assessment of Stanislaus County Geographic Regions .....	I-299
2-13	Keyes Crime Indices .....	I-309
2-14	San Joaquin Valley Air Basin Air Quality Attainment Status .....	I-312
2-15	Stanislaus County Days in Exceedance of State and Federal Air Quality Standards, 2013.....	I-313
2-16	Community Health Assessment of Stanislaus County Geographic Regions .....	I-313
2-17	Monterey Park Tract Crime Indices .....	I-322
2-18	San Joaquin Valley Air Basin Air Quality Attainment Status .....	I-324
2-19	Stanislaus County Days in Exceedance of State and Federal Air Quality Standards, 2013.....	I-325
2-20	Community Health Assessment of Stanislaus County Geographic Regions .....	I-326
2-21	Riverdale Park Tract DUC Crime Indices .....	I-333
2-22	San Joaquin Valley Air Basin Air Quality Attainment Status .....	I-336
2-23	Stanislaus County Days in Exceedance of State and Federal Air Quality Standards, 2013.....	I-337
2-24	Community Health Assessment of Stanislaus County Geographic Regions .....	I-337
2-25	Westley Crime Indices.....	I-346
2-26	San Joaquin Valley Air Basin Air Quality Attainment Status .....	I-348
2-27	Stanislaus County Days in Exceedance of State and Federal Air Quality Standards, 2013.....	I-349
2-28	Community Health Assessment of Stanislaus County Geographic Regions .....	I-350



# Figures

---

## Follows Page

1-1	Disadvantaged Unincorporated Communities in Stanislaus County .....	I-264
2-1	Cowan Tract Disadvantaged Unincorporated Community .....	I-267
2-2	Crows Landing Disadvantaged Unincorporated Community.....	I-280
2-3	Grayson Disadvantaged Unincorporated Community.....	I-293
2-4	Keyes Disadvantaged Unincorporated Community.....	I-306
2-5	Monterey Park Tract Disadvantaged Unincorporated Community.....	I-319
2-6	Riverdale Park Tract Disadvantaged Unincorporated Community.....	I-332
2-7	Westley Disadvantaged Unincorporated Community .....	I-343

***THIS PAGE INTENTIONALLY LEFT BLANK***

## Acronyms and Abbreviations

---

AB	Assembly Bill
ACE	Altamont Commuter Express
AGS	Applied Geographic Solutions
BART	Bay Area Rapid Transit
CAT	Ceres Area Transit
CDP	Census-Designated Place
CHA	Community Health Assessment of Stanislaus County
CSA	County Service Area
CSD	County Service Area
DUC	disadvantaged unincorporated community
FBI	Federal Bureau of Investigation
FPD	Fire Protection District
General Plan	<i>Stanislaus County General Plan</i>
GHG	greenhouse gas
GIS	geographic information system
I-5	Interstate 5
LAFCO	Local Agency Formation Commissions
LEB	life expectancy at birth
LOS	level of service
MAX	Modesto Area Express
MCL	maximum contaminant level
P-D	Planned Development District
PM	particulate matter
PM10	particulate matter of 10 microns or less
PM2.5	particulate matter of 2.5 microns or less
SB	Senate Bill
SJVAB	San Joaquin Valley air basin
SJVAPCD	San Joaquin Valley Air Pollution Control District
SOI	sphere of influence
SR	State Route
StaRT	Stanislaus Regional Transit
WSID	Westside Irrigation District

***THIS PAGE INTENTIONALLY LEFT BLANK***

## Background and Overview of Statutory Requirements

---

Senate Bill (SB) 244 of 2011 mandates that city and county general plans consider disadvantaged unincorporated communities (DUCs) and the availability of services to such communities. SB 244 states, in part: “It is the intent of the Legislature to encourage investment in these communities and address the complex legal, financial, and political barriers that contribute to regional inequity and infrastructure deficits within disadvantaged unincorporated communities.” SB 244 also establishes requirements for Local Agency Formation Commissions (LAFCO) to consider DUCs relating to agency formation and annexation proposals, and as part of their municipal service reviews.

Accordingly, the general plan must include analyses of the water, wastewater, stormwater drainage, and structural fire protection needs or deficiencies of those communities, and a discussion of benefit assessment districts or other financing alternatives that could make the extension of services to such communities financially feasible (Government Code Section 65302.10).

Responsibility for addressing the concerns of DUCs is split between cities and counties, depending on the location and age of such communities. Government Code Section 65302.10(b)(1) provides that a county must include “an identification of each legacy community within the boundaries of the county that is a disadvantaged unincorporated community, but not including any area within the sphere of influence of any city. This identification shall include a description of the community and a map designating its location.” *Community* is defined as “an inhabited area within a city or county that is comprised of no less than 10 dwellings adjacent or in close proximity to one another.” *Legacy community* is defined as “a geographically isolated community that is inhabited and has existed for at least 50 years.”

The selection criteria for DUCs subject to Stanislaus County jurisdiction are as follows:

- Identified community (Census-Designated Place, or CDP), with distinguishable boundaries, located within the unincorporated area of the county.
- Developed, with 10 dwellings, or 12 or more registered voters.
- Annual median income of households is less than 80% of the statewide median household income.
- Outside of the sphere of influence of any city.

As defined under Government Code Section 65302.10, the DUCs within Stanislaus County that fall within the responsibility of the *Stanislaus County General Plan* (General Plan) are listed below and shown in Figure 1-1, *Disadvantaged Unincorporated Communities in Stanislaus County*.

- Cowan Tract.
- Crows Landing.
- Grayson.
- Keyes.
- Monterey Park Tract.

- Riverdale Park Tract.
- Westley.

These DUCs are the subject of this report, which compiles information from various sources to characterize the conditions in each DUC. This includes geographic information system (GIS) files for infrastructure, the most recent Municipal Service Reviews prepared by the Stanislaus County LAFCO, and available health information. There is no community-specific health information available; consequently, the DUCs are discussed in the context of the nine geographic areas by which the information is presented in the 2013 *Community Health Assessment of Stanislaus County* prepared by the Stanislaus County Health Services Agency. The references used in Chapter 2, *Existing Conditions*, are identified after the discussion of each DUC.

This report was prepared with partial funding from a grant from the California Strategic Growth Council and goes beyond the basic provisions of SB 244, which specifically requires consideration of water, wastewater, stormwater drainage, and structural fire protection needs or deficiencies. In addition to those services and in order to meet the requirements of the California Strategic Growth Council grant, this report includes information on air quality, public health issues, and the presence or absence of additional factors, such as community services, that result from or contribute to a community's general health.

The report is organized in the following chapters:

- Chapter 1, *Background and Overview of Statutory Requirements*
- Chapter 2, *Existing Conditions*, documents the existing infrastructure, services, and chronic health issues for each of the identified DUCs
- Chapter 3, *Community Assets and Deficits*, describes the condition of infrastructure and services for each DUC
- Chapter 4, *Healthy Communities Strategies*, recommends a number of policies that will further the development of healthy communities.

Path: K:\Projects\_1\County\_of\_Stanislaus\00203\_10\_DACA\mapdoc\IUCs\Fig1\_Overview.mxd; User: 19393; Date: 6/8/2015

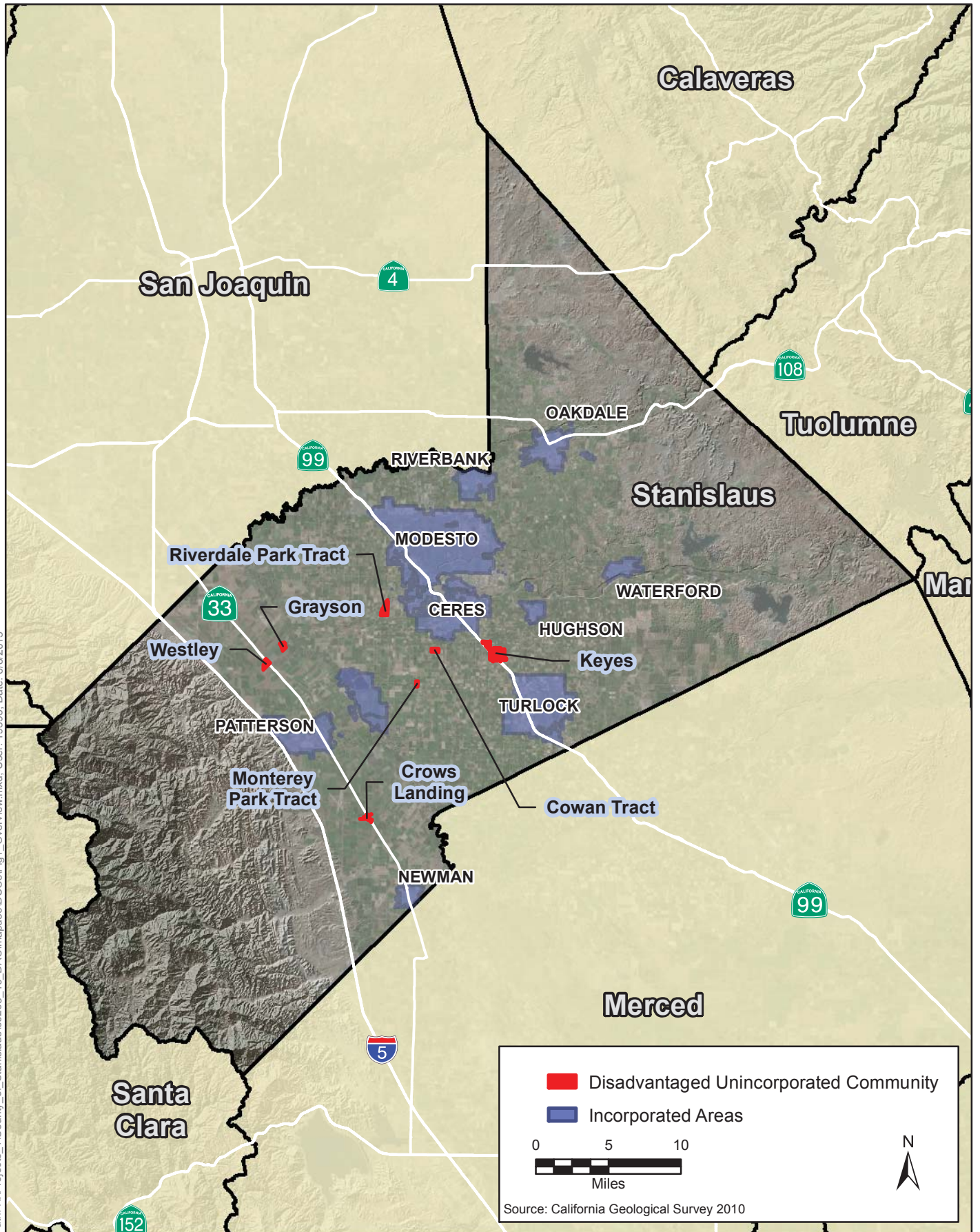

**Figure 1-1**  
**Disadvantaged Unincorporated Communities**  
**in Stanislaus County**



***THIS PAGE INTENTIONALLY LEFT BLANK***



## 2.1 Cowan Tract

### 2.1.1 General Characteristics and Demographics

Located approximately 1 mile southwest of the city of Ceres, Cowan Tract is a rural neighborhood primarily comprised of mobile homes. Cowan Tract is a CDP with a 2010 census population of 318 people in 94 households and an average household size of 3.38 persons (United States Census Bureau 2013a). The median annual household income in California was \$60,190 in 2013; it was \$39,563 in Cowan Tract (United States Census Bureau 2013b). In 2010, Cowan Tract had 102 housing units, 94 of which were occupied (United States Census Bureau 2013a).

At 102 acres, the Cowan CDP occupies a larger area than the 78-acre area identified as the Cowan Tract DUC described below and encompasses approximately 24 acres of agricultural land immediately south of the DUC. All of the land immediately surrounding the Cowan Tract DUC is zoned General Agriculture, with a 40-acre minimum parcel size (A-2-40) (Stanislaus County 2014d). The western part of the agricultural land is classified by the California Department of Conservation's Important Farmlands Inventory as "semi-agricultural and rural commercial land," defined as "farmsteads, agricultural storage and packing sheds, unpaved parking areas, composting facilities, equine facilities, firewood lots, and campgrounds" (California Department of Conservation 2014); most of this area is also under Williamson Act contract (California Department of Conservation 2012). The eastern portion of the agricultural acreage is non-Williamson Act contracted prime farmland (California Department of Conservation 2012 and 2014). These agricultural lands do not support the requisite intensity of existing development for SB 244 consideration and are unlikely to develop; therefore, they are not included as part of the Cowan Tract DUC residential community evaluated for SB 244 purposes.

Cowan Tract DUC is defined by San Joaquin Street on the north, the Union Pacific Railroad tracks on the east, Lathrop Street on the south, and Crows Landing Road on the west. Turlock Irrigation District's Lower Lateral No. 2½ parallels the south side of Lathrop Street, separating Cowan Tract from neighboring farmland to the south. The area is surrounded by agricultural land and accompanying agriculture-related residences, with the exception of the driving range/9-hole golf course located immediately north of Cowan Tract's northwest corner.

The General Plan's Housing Element identifies Cowan Tract as a Residential Development Potential Study Area, noting that Cowan Tract does not have the potential to accommodate additional housing units (Stanislaus County 2012). Existing infrastructure and services for Cowan Tract—like many rural areas—are limited; these are described below.

### 2.1.2 Infrastructure, Utilities, and Services

Infrastructure, utilities, and services considered for the Cowan Tract DUC are presented in Figure 2-1, *Cowan Tract Disadvantaged Unincorporated Community*, and include transportation facilities and services including roads, sidewalks, street lighting, and bus stops/service; water,

wastewater, and storm drainage systems; solid waste disposal; public safety services such as law enforcement and fire protection; and access to community amenities and services such as schools, parks, and grocery stores. Data associated with chronic health conditions and air quality are described at a regional level because they are not available for Cowan Tract DUC specifically.

### 2.1.3 Transportation Facilities and Services

Cowan Tract lies approximately 4 miles west of State Route (SR) 99, a major north-south travel corridor and a six-lane freeway in Stanislaus County. Transportation infrastructure in the immediate Cowan Tract area consists of a mixture of public, County-maintained roads and privately maintained roadways, and railroad tracks. County-maintained roads include San Joaquin Street, Crows Landing Road, the western half of Cowan Road, and the northern halves of Avenues A, B, and C. San Joaquin Street forms the DUC's northern edge and, like the roads within Cowan Tract, consists of a narrow, two-lane local road with no sidewalks, curbs, or bicycle lanes.

Crows Landing Road, adjacent to the west side of Cowan Tract, is a two-lane major roadway; in the vicinity of Cowan Tract the road currently has two lanes plus a center bidirectional turn lane (Stanislaus Council of Governments 2014). The County General Plan Circulation Element designates Crows Landing Road as a four-lane expressway, a category of road intended to move high volumes of people and goods between urban areas within the county at higher speeds (Stanislaus County 2006). The level of service (LOS) on that segment of Crows Landing Road has not been recorded; however, the segment between Grayson Road (0.25 mile north of Cowan Tract) and Service Road (1.25 miles north of Cowan Tract) operates at LOS D, below Stanislaus County's LOS C goal and at the minimum adopted level of service allowed by the General Plan (Stanislaus County 2006; Stanislaus Council of Governments 2014). Crows Landing Road, including the segment adjacent to Cowan Tract, is proposed for widening and designated in the draft Circulation Element as a future six-lane expressway (County of Stanislaus (no date) Stanislaus Council of Governments 2014).

The 2013 *Stanislaus County Non-Motorized Facilities Master Plan* identifies Crows Landing Road north of Cowan Tract as 1 of 10 countywide first-tier—or high-priority—bikeways scheduled for improvement (Stanislaus Council of Governments 2013). Adjacent to and south of Cowan Tract, Crows Landing Road is designated as a planned Class 3 bikeway (Stanislaus Council of Governments 2013).

Within the Cowan Tract DUC, private roads that are not maintained by the County include Avenues A, B, and C south of Cowan Street; Cowan Street east of Avenue C; and the entirety of Avenue D and Lathrop Street—all of these are two-lane local roads. No sidewalks are present on any of the Cowan Tract roads, and there are no designated bicycle lanes beyond those on Crows Landing Road.

No curbs, gutters, or street lights are present on the roadways in and around Cowan Tract (Stanislaus County 2012). The Union Pacific railroad tracks extend north-south immediately east of Cowan Tract.

Bus service within Cowan Tract is limited to the Turlock–Modesto Shuttle, which provides four roundtrips between Turlock and Modesto, with curbside service, to the general public Monday–Saturday between 7:00 a.m. and 6:30 p.m. (Stanislaus Regional Transit 2014a).

The nearest fixed bus routes to Cowan Tract are Ceres Area Transit (CAT) Route B, Modesto Area Express (MAX) Route 42, and Stanislaus Regional Transit (StaRT) Route 40 (City of Ceres 2014; City of Modesto 2014; Stanislaus Regional Transit 2014a). CAT Route B runs buses nine times per day,

Path: K:\Projects\_1\County\_of\_Stanislaus\00203\_10\_DAC\mapdoc\IDUCs\Fig2\_ServicesA.mxd; User: 19393; Date: 6/9/2015



**Figure 2-1**  
**Cowan Tract Disadvantaged Unincorporated Community**

***THIS PAGE INTENTIONALLY LEFT BLANK***

Monday–Friday, connecting Ceres and Modesto between the hours of 8:15 a.m. and 6:10 p.m.; no weekend service is provided on CAT Route B (City of Ceres 2013). The nearest CAT Route B bus stop is approximately 1.25 miles north of Cowan Tract at the northeast corner of Crows Landing and Service Roads. MAX Route 42 provides bus service every 30 minutes between the hours of 5:51 a.m. and 7:59 p.m. Monday–Saturday and 8:45 a.m.–6:40 p.m. on Sundays; the nearest MAX bus stop to Cowan Tract is 1.75 miles north at the Stanislaus County Community Services Agency/Community Safety Center facility on Hackett Road (City of Modesto 2009c). All CAT and MAX buses are equipped with bicycle racks (City of Modesto 2009a; City of Ceres 2014). StaRT Route 40 connects Modesto, Grayson, Westley, and Patterson, and passes 0.25 mile north of Cowan Tract on Crows Landing and Grayson Roads. StaRT Route 40 provides round trips between Modesto and Patterson; Monday–Friday, there are eight round trips, running approximately every 2 hours from 5:20 a.m. to 9:08 p.m.; on Saturdays, there are five round trips, running every 2 hours and 45 minutes from 8:15 a.m. to 8:12 p.m.; no StaRT buses run on Route 40 on Sundays (Stanislaus Regional Transit 2014b). The nearest StaRT Route 40 bus stop to Cowan Tract is 1.75 miles north at the Stanislaus County Community Services Agency/Community Safety Center facility on Hackett Road (Stanislaus Regional Transit 2014b). All three routes, CAT Route B, MAX Route 42, and StaRT Route 40, connect to Modesto’s Downtown Transportation Center, from which riders can transfer and connect to the Modesto Amtrak station, the Altamont Commuter Express (ACE) train station in Lathrop, and the Dublin Bay Area Rapid Transit (BART) station (Stanislaus Regional Transit 2014c; City of Modesto 2009b).

## 2.1.4 Water, Wastewater, and Stormwater Drainage Systems

No community services district serves Cowan Tract. Water is obtained through individual private wells, and wastewater is disposed through private septic systems (Stanislaus County 2012). Like many rural areas, storm drainage in the vicinity of Cowan Tract consists of either field percolation or roadside ditches that drain to nearby creeks. No storm drainage system serves Cowan Tract.

## 2.1.5 Solid Waste Disposal

Stanislaus County contracts with four franchised solid waste collection companies, Bertolotti Disposal, Gilton Solid Waste, Modesto Disposal/Waste Management, and Turlock Scavenger, for residential and commercial garbage collection service in unincorporated Stanislaus County (Stanislaus County 2014a). Cowan Tract falls within County-designated Franchise Area 1, served by Bertolotti Disposal (Stanislaus County 2014b). Besides providing solid waste and recyclables collection services to Franchise Area 1, Bertolotti Disposal operates a transfer station, open to the public Monday–Saturday, on Flamingo Road in Ceres. Additionally, Stanislaus County’s Fink Road Sanitary Landfill, a Class III landfill for nonhazardous municipal solid waste, is operated by the County’s Department of Environmental Resources and is open Monday–Saturday to private citizens, school districts, businesses, and local agencies for individual disposal of solid waste (Stanislaus County 2014c).

## 2.1.6 Law Enforcement and Fire Protection

Law enforcement services for Cowan Tract, as for the rest of unincorporated Stanislaus County and four contract cities, are provided by the Stanislaus County Sheriff’s Department. The nearest sheriff’s station to Cowan Tract is the main station, approximately 2.3 miles north at 250 East Hackett Road in Ceres.

The operations division of the Sheriff's Department provides law enforcement services to over 200,000 people in a 1,521-square-mile area (Stanislaus County Sheriff's Department 2014). Two units—patrol and investigations—comprise the Sheriff's Department operations division. The patrol unit responds to calls for assistance, investigates crime, makes arrests, and performs preventive patrol services (Stanislaus County Sheriff's Department 2014). The investigations unit follows up reports of major crimes, collects and prepares evidence for trials, apprehends offenders, and recovers stolen property (Stanislaus County Sheriff's Department 2014).

The crime rates presented below were compiled by Applied Geographic Solutions (AGS) using the primary reporting categories from the Federal Bureau of Investigation (FBI) 2005 – 2010 Uniform Crime Report databases, along with preliminary 2011 release data and census data related to socioeconomic characteristics. The crimes are divided into two main categories: personal crimes (murder, rape, robbery, and assault) and property crimes (burglary, larceny, and motor vehicle theft). These crime rates are based on a comparison of the average local crime rate to the national average for the same crime, with a crime index of 100 considered average; scores above 100 are therefore considered greater, or worse, than average. For example, a score of 130 would represent a crime rate 30% greater than the national average for that type of crime. These crime rates are unweighted (i.e., a murder and a theft carry the same weight for calculation purposes) and are tracked at the census block group level and above, which may not correspond precisely to the DUC boundaries. Census blocks are the smallest geographic area for which the United States Census Bureau collects and tabulates data; a set of these constitutes a census block group. Census blocks vary widely in geographic size and are generally smaller in urban areas and progressively larger in suburban, rural, or remote areas; a given block group is larger in area and population than the individual census blocks of which it is made, and generally contains between 600 and 3,000 people (United States Census Bureau 1994). Cowan Tract DUC falls within census block group 060990030.021.

The overall personal crime and property crime indices for Cowan Tract are 141 and 85, respectively, which means that personal crimes in Cowan Tract occur at a rate 41% higher than the nationwide average, and property crimes occur at a rate of 85% of the national average. The general and individual crime indices for these categories are shown in Table 2-1 below.

**Table 2-1. Cowan Tract Crime Indices**

Personal Crime		Property Crime	
Personal Crime Index	141	Property Crime Index	85
Murder	166	Burglary	166
Rape	114	Larceny	97
Robbery	67	Motor Vehicle Theft	12
Assault	187		

Source: Applied Geographic Solutions and Atlas Publishing 2012.

The Westport Fire Protection District (FPD) provides fire protection and emergency response services to the Cowan Tract area from its one fire station, located approximately 2.5 miles west at 5160 South Carpenter Road. The Westport fire station serves a 45-square-mile area with a staff of 17 volunteer firefighters and houses two engines, one water tender, and one rescue vehicle (Emergency Services Consulting 2007). The station's workload, defined by the number of incidents

per year, increased from just over 100 in 1987 to about 300 in 2005 (Emergency Services Consulting 2007).

A fire department's ability to meet the fire protection needs of its service area is typically evaluated by the Insurance Services Office (ISO), a private organization that assesses risks, including fire protection, for insurance purposes. The ISO considers a variety of factors, including a district's fire-fighting apparatus, staffing, training, location, and water supply, to rate fire departments on a scale from 1 (best fire protection possible) to 10 (no fire protection). The ISO rating therefore reflects a fire department's ability to protect the residents and businesses within its service area from fire. Westport FPD has an ISO rating of 8 within a 5-mile radius of the station (Emergency Services Consulting 2007).

## 2.1.7 Schools and Community Amenities

Cowan Tract lies within the boundaries of the Ceres Unified School District, which includes a total of 22 schools serving a total of 12,742 students in grades K–12 (Ceres Unified School District 2014a). The nearest elementary school to Cowan Tract is Westport Elementary, which is 2.9 miles west at 5218 South Carpenter Road. This school serves 454 students in grades K–6 (California Department of Education 2014c; Ceres Unified School District 2013). The nearest junior high school is Blaker Kinser Junior High School, serving 612 students in grades 7 and 8, approximately 4 miles northeast of Cowan Tract at 1601 Kinser Road in Ceres. The nearest high school is Central Valley High School, 3.5 miles northeast at 4033 South Central Avenue in Ceres (California Department of Education 2014a). Central Valley High School serves 1,686 students in grades 9–12 (California Department of Education 2014b). The school district provides bus transportation to and from school for students living beyond walking distance to their schools (Ceres Unified School District 2014b).

Several city parks lie approximately 1.5–2 miles northeast of Cowan Tract in southwest Ceres. Of these, Sam Ryno Park, at about 1.5 miles, is the closest but has no developed amenities; nearby developed park and recreational facilities include Strawberry Fields Park, Don Pedro Park, and Central Valley High School. Strawberry Fields Park is a neighborhood park featuring picnic facilities and play equipment, and Don Pedro Park features picnic facilities, play equipment, and an adult fitness area (City of Ceres 2010). The City of Ceres considers school facilities to be joint-use recreational facilities (City of Ceres 1997). Developed recreational amenities at Central Valley High School include baseball/softball fields, soccer fields, tennis courts, and a track.

The nearest grocery store to Cowan Tract is Joe's Food Mart, a small convenience market, approximately 0.25 mile north of Cowan Tract at the corner of Crows Landing Road and West Grayson Road. The nearest full-service supermarkets are Magic Market, 2.7 miles northeast of Cowan Tract at 3900 Morgan Road in Ceres, and La Perla Tapatia, 2.9 miles north of Cowan Tract at 2031 Crows Landing Road in Modesto.

## 2.1.8 Air Quality and Chronic Health Conditions

Stanislaus County is within the northern part of the eight-county San Joaquin Valley Air Pollution Control District (SJVAPCD), a regional public health agency responsible for air quality management in those eight counties. SJVAPCD cites several factors that contribute to the valley's air quality challenges, including high rates of chronic poverty and unemployment coupled with a high population growth rate, the presence of major transportation corridors, and topographic features such as the surrounding mountains combined with the area's meteorological conditions (San

Joaquin Valley Air Pollution Control District 2014a). SJVAPCD notes that two pollutants—ozone and particulate matter (PM) of both 10 microns or less (PM10) and 2.5 microns or less (PM2.5)— are of special concern, causing or exacerbating a variety of health conditions (San Joaquin Valley Air Pollution Control District 2014a). The presence of PM2.5, primarily a winter condition, triggers heart attacks, asthma, bronchitis, and respiratory infections, and has a strong correlation with hospital admissions and deaths (San Joaquin Valley Air Pollution Control District 2014a).

GHGs are not a criteria air pollutant and do not directly affect human health. GHG emissions are largely the result of combustion, decay and digestive processes, and emissions of industrial gases with high climate change potential. Unlike criteria pollutants such as carbon monoxide, PM10, PM2.5, and ozone, GHGs do not collect within a specific area or air basin. Their harm is done at a global level through the effect of increased concentrations of GHGs in Earth's atmosphere.

Worldwide concern over GHG emissions is based on the climate change that they are causing by altering the way in which Earth's atmosphere traps solar radiation as heat. The adverse effects of global climate change include rising sea levels, changes in habitat conditions for plants and animals, increased potential for wildfires, more severe weather extremes, and a reduction in California's winter snow pack, among others. Through the impetus of Assembly Bill (AB) 32 (California Global Warming Solutions Act of 2006) and SB 375 (Sustainable Communities and Climate Protection Act of 2008), California has undertaken a statewide program of reducing GHG emissions to 1990 levels by 2020 in order to slow the rate of global climate change.

Climate change can have an indirect effect on human health in Stanislaus County to the extent that it results in warmer summer temperatures that facilitate ozone formation and exacerbate heat-related stress among outdoor workers, the elderly, small children, and the infirm. The amount of GHGs emitted within the Cowan Tract DUC is not atypical for a small, rural community.

SJVAPCD operates 36 air monitoring sites within its eight-county air basin. Of these, two air quality stations, one in Modesto and another in Turlock, monitor air quality within Stanislaus County. The Modesto monitoring site is the closest to Cowan Tract, approximately 5.5 miles north of the community. Table 2-2 shows the San Joaquin Valley air basin's (SJVAB's) current air quality attainment status for state and federal criteria pollutants (San Joaquin Valley Air Pollution Control District 2012).



**Table 2-2. San Joaquin Valley Air Basin Air Quality Attainment Status**

Pollutant	Designation/Classification	
	Federal Standards	State Standards
Ozone—1-hour	No Federal Standard <sup>a</sup>	Nonattainment/Severe
Ozone—8-hour	Nonattainment/Extreme <sup>b</sup>	Nonattainment
PM 10	Attainment <sup>c</sup>	Nonattainment
PM 2.5	Nonattainment <sup>d</sup>	Nonattainment
Carbon monoxide	Attainment/Unclassified	Attainment/Unclassified
Nitrogen dioxide	Attainment/Unclassified	Attainment
Sulfur dioxide	Attainment/Unclassified	Attainment
Lead (particulate)	No Designation/Classification	Attainment
Hydrogen sulfide	No Federal Standard	Unclassified
Sulfates	No Federal Standard	Attainment
Visibility reducing particles	No Federal Standard	Unclassified
Vinyl chloride	No Federal Standard	Attainment

Source: San Joaquin Valley Air Pollution Control District 2012.

- <sup>a</sup> Effective June 15, 2005, the U.S. Environmental Protection Agency (EPA) revoked the federal 1-hour ozone standard, including associated designations and classifications. EPA had previously classified the San Joaquin Valley air basin (SJVAB) as extreme nonattainment for this standard. EPA approved the 2004 Extreme Ozone Attainment Demonstration Plan on March 8, 2010 (effective April 7, 2010). Many applicable requirements for extreme 1-hour ozone nonattainment areas continue to apply to the SJVAB.
- <sup>b</sup> Though the SJVAB was initially classified as serious nonattainment for the 1997 8-hour ozone standard, EPA approved Valley reclassification to extreme nonattainment in the Federal Register on May 5, 2010 (effective June 4, 2010).
- <sup>c</sup> On September 25, 2008, EPA redesignated the SJVAB to attainment for the PM10 National Ambient Air Quality Standard (NAAQS) and approved the PM10 Maintenance Plan.
- <sup>d</sup> The SJVAB is designated nonattainment for the 1997 PM2.5 NAAQS. EPA designated the SJVAB as nonattainment for the 2006 PM2.5 NAAQS on November 13, 2009 (effective December 14, 2009).

Over the past decade, ozone levels have been trending downward within the SJVAB and, in 2013, for the first time on record, the air basin overall had zero violations of the federal hourly ozone standard, compared to 281 violations in 1996 (San Joaquin Valley Air Pollution Control District 2014b). At the same time, PM2.5 and PM10 levels have fluctuated with no clear upward or downward trend (California Air Resources Board 2015). Table 2-3 presents the number of days in which Stanislaus County ozone, PM2.5, and PM10 levels exceeded state and federal air quality standards in 2013 (California Air Resources Board 2015).

**Table 2-3. Stanislaus County Days in Exceedance of State and Federal Air Quality Standards, 2013**

Monitoring Site	Ozone			PM 2.5	PM 10
	# Days > State 1-Hr Standard	# Days > National '08 8-Hr Standard	# Days > State 8-Hr Standard	Est Days > National 24-Hr Standard	Est Days > State 24-Hr Standard
Modesto 14th St.	0	2	13	37.6	57.7
Turlock S. Minaret St.	1	14	24	40.3	73.7

Source: California Air Resources Board 2015.

The 2013 *Community Health Assessment of Stanislaus County* (CHA), prepared by the Stanislaus County Health Services Agency, presents data about the health and well-being of Stanislaus County residents, including information on the burden of five major chronic diseases—hypertension, heart disease, stroke, diabetes, and asthma—and the environmental and behavioral factors that influence their prevalence. Primary environmental factors identified in the CHA as contributing to these chronic health conditions are air quality and retail food environment; behavioral factors include diet, fast food consumption, fruit and vegetable consumption, quality of clinical care, physical activity, obesity, and tobacco use (Stanislaus County Health Services Agency 2013). As measured in 2007, Stanislaus County has the second worst retail food environment in California, with 5.48 fast-food purveyors and convenience stores for every grocery store or produce vendor near residences, compared to 4.48 statewide, and a high rate of fast food consumption in the low income population (Stanislaus County Health Services Agency 2013). The county also has the highest prevalence of obesity in the state (31.5% compared to 21.2% statewide), particularly among males, and a higher percentage of smokers than the California average (Stanislaus County Health Services Agency 2013).

The CHA presents countywide data and also divides Stanislaus County into nine geographic regions, shown in Table 2-4 below. Cowan Tract falls within the central region identified in Table 2-4.

**Table 2-4. Community Health Assessment of Stanislaus County Geographic Regions**

Region	Communities
Central	Modesto (parts) and outlying areas, including Cowan Tract, with ZIP codes 95350, 95355, 95357, and 95358
East Central	Airport Neighborhood and East Modesto (parts) with ZIP code 95354
Southeast Side	Denair, Empire, Hughson, Hickman, La Grange, Waterford with ZIP codes 95316, 95319, 95326, 95323, 95329, and 95386
Northeast Side	Knights Ferry, Valley Home, Oakdale, Riverbank with ZIP codes 95230, 95361, and 95367
North Side	Del Rio, Salida and Modesto (parts) with ZIP codes 95356 and 95368
Southwest Central	West Modesto and South Modesto with ZIP code 95351
West Side	Crows Landing, Grayson, Newman, Patterson with ZIP codes 95313, 95360, 95363, 95385, and 95387
South Central	Ceres, Keyes with ZIP codes 95307 and 95328
South Side	Turlock with ZIP codes 95380 and 95382

Source: Stanislaus County Health Services Agency 2013:Table 2.

Chronic health conditions of concern within Stanislaus County include hypertension, heart disease, stroke, diabetes and asthma. According to the CHA, the percentage of Stanislaus adults diagnosed with high blood pressure increased 31.2% between 2001 and 2009, and surpassed the percentage of California adults diagnosed with high blood pressure use. As of 2009, approximately 30.7% of Stanislaus County adults were diagnosed with hypertension, compared to 26.2% statewide. Among Stanislaus County's nine regions, the central region, including Cowan Tract, ranks fifth for hypertension-related emergency room visits, fourth highest for hypertension-related hospitalizations, and fifth for hypertension-related mortality (Stanislaus County Health Services Agency 2013).

The CHA notes that in 2009, 5% of Stanislaus County adults had been diagnosed with heart disease, compared to 5.9% statewide and 12% of adults nationwide. The central region of Stanislaus County, including Cowan Tract, ranks third-lowest for heart disease-related emergency room visits among the county's nine regions, has the fourth-lowest rate of heart disease-related hospitalizations, and has the third-highest rate of heart disease-related mortality (Stanislaus County Health Services Agency 2013).

The CHA indicates that the California Health Interview Survey, on which it relies for some data, has not consistently tracked either the overall prevalence of cancer or the rates of individual types of cancer; data for cancer rates is therefore less current than for other more closely tracked conditions. Although the percentage of Stanislaus County adults diagnosed with cancer has increased from 7.4% in 2001 to 8.5% in 2005, it remains lower than the statewide rate. However, at a rate of approximately 21.4% of all deaths annually, cancer is the second most common cause of death in Stanislaus County. The central region of Stanislaus County, including Cowan Tract, ranks fourth-lowest among the nine regions for cancer-related emergency room visits, fifth for cancer-related hospitalizations, and has the fourth-highest rate of cancer-related mortality (Stanislaus County Health Services Agency 2013).

Diabetes, according to the CHA, affects 8.3% of the United States population and is the seventh leading cause of death nationwide. Within California, from 2001 to 2007, the percentage of people diagnosed with diabetes increased from 6.2% to 8.5%, a 37% increase. Trends in Stanislaus County are consistent with the statewide increase; in 2009, 7.6% of adults in Stanislaus County had been diagnosed with diabetes. While the prevalence of diabetes was lower in Stanislaus County than California, in 2011, Stanislaus County had higher hospitalization rates than California for four primary indicators of diabetes management, including hospitalization for short-term complications, long-term complications, lower-extremity amputation, and uncontrolled diabetes (Stanislaus County Health Services Agency 2013). Among Stanislaus County's nine regions, the central region, including Cowan Tract, ranks fifth for diabetes-related emergency room visits and hospitalizations, and fourth-highest for diabetes-related mortality (Stanislaus County Health Services Agency 2013).

According to the CHA, in 2009 the percentage of Stanislaus County adults diagnosed with asthma was 21.8%, compared to 13.5% of the adult population statewide. Among Stanislaus County's nine regions, the central region, including Cowan Tract, has the third-highest rate of asthma-related emergency room visits and ranks fifth for asthma-related hospitalizations (Stanislaus County Health Services Agency 2013). Due to the low asthma-related death rate, the CHA does not track or rank asthma-related mortality.

The CHA also uses life expectancy at birth (LEB) as a measure of quality of life within Stanislaus County and each of its nine regions. LEB is defined as the number of years a newborn infant is

projected to live if mortality patterns at the time of its birth were to remain the same throughout its life. The LEB for Stanislaus County is calculated to be 77.2 years, 1.7 year less than the nationwide LEB of 78.9. The LEBs within the nine Stanislaus County regions range from a high of 80.27 years to a low of 75.01 years; the central region, which includes Cowan Tract, ranks second-shortest among these, with a LEB of 77.73 years (Stanislaus County Health Services Agency 2013).

## 2.1.9 References

- Applied Geographic Solutions and Atlas Publisher. 2012. Crime Index for the U.S. Retrieved through ArcGIS. Available: [http://megacity.esri.com/ArcGIS/rest/services/Demographics/USA\\_CrimeIndex/MapServer](http://megacity.esri.com/ArcGIS/rest/services/Demographics/USA_CrimeIndex/MapServer). Accessed: 2012.
- California Air Resources Board. 2015. Select 8 Summary. Available: <http://www.arb.ca.gov/adam/select8/sc8start.php>. Accessed: January 22, 2015.
- California Department of Conservation. 2012. Division of Land Resource Protection. *Stanislaus County Williamson Act FY 2010/2011, Sheet 1 of 2*. Available: [ftp://ftp.consrv.ca.gov/pub/dlrp/wa/stanislaus\\_north\\_10\\_11\\_WA.pdf](ftp://ftp.consrv.ca.gov/pub/dlrp/wa/stanislaus_north_10_11_WA.pdf). Accessed: January 16, 2015.
- California Department of Conservation. 2014. Division of Land Resource Protection. *Rural Land Mapping Edition, Stanislaus County Important Farmland 2012, Sheet 1 of 2*. Available: [ftp://ftp.consrv.ca.gov/pub/dlrp/FMMP/pdf/2012/sta12\\_no.pdf](ftp://ftp.consrv.ca.gov/pub/dlrp/FMMP/pdf/2012/sta12_no.pdf). Accessed: January 16, 2015.
- California Department of Education. 2014a. Blaker Kinser Junior High School Profile: Fiscal Year 2013–14. Available: [http://www.ed-data.k12.ca.us/App\\_Resx/EdDataClassic/fsTwoPanel.aspx?#!bottom=/\\_layouts/EdDataClassic/profile.asp?tab=0&level=07&ReportNumber=16&County=50&fyr=1314&District=71043&School=6112346](http://www.ed-data.k12.ca.us/App_Resx/EdDataClassic/fsTwoPanel.aspx?#!bottom=/_layouts/EdDataClassic/profile.asp?tab=0&level=07&ReportNumber=16&County=50&fyr=1314&District=71043&School=6112346). Accessed: November 19, 2014.
- California Department of Education. 2014b. Central Valley High School Profile: Fiscal Year 2013–14. Available: [http://www.ed-data.k12.ca.us/App\\_Resx/EdDataClassic/fsTwoPanel.aspx?#!bottom=/\\_layouts/EdDataClassic/profile.asp?tab=0&level=07&ReportNumber=16&County=50&fyr=1314&District=71043&School=0108076](http://www.ed-data.k12.ca.us/App_Resx/EdDataClassic/fsTwoPanel.aspx?#!bottom=/_layouts/EdDataClassic/profile.asp?tab=0&level=07&ReportNumber=16&County=50&fyr=1314&District=71043&School=0108076). Accessed: November 19, 2014.
- California Department of Education. 2014c. Westport Elementary School Profile: Fiscal Year 2013–14. Available: [http://www.ed-data.k12.ca.us/App\\_Resx/EdDataClassic/fsTwoPanel.aspx?#!bottom=/\\_layouts/EdDataClassic/profile.asp?tab=0&level=07&ReportNumber=16&County=50&fyr=1314&District=71043&School=6052468](http://www.ed-data.k12.ca.us/App_Resx/EdDataClassic/fsTwoPanel.aspx?#!bottom=/_layouts/EdDataClassic/profile.asp?tab=0&level=07&ReportNumber=16&County=50&fyr=1314&District=71043&School=6052468). Accessed: November 19, 2014.
- Ceres Unified School District. 2013. *Elementary School Attendance Boundary Map*. Updated July, 2013. Available: [http://ceres.sharpschool.net/UserFiles/Servers/Server\\_5439645/File/parent%20resources/AttendanceBoundaryMap.pdf](http://ceres.sharpschool.net/UserFiles/Servers/Server_5439645/File/parent%20resources/AttendanceBoundaryMap.pdf). Accessed: November 19, 2014.
- Ceres Unified School District. 2014a. *Information*. Available: <http://www.ceres.k12.ca.us/cms/one.aspx?objectId=5967878>. Accessed: November 19, 2014.

- Ceres Unified School District. 2014b. *Transportation*. Available: [http://www.ceres.k12.ca.us/business\\_services/transportation](http://www.ceres.k12.ca.us/business_services/transportation). Accessed: November 19, 2014.
- City of Ceres. 2013. *Schedule: CAT Route B - Herndon / Service Rd. / Hackett / Crows Landing Rd.* Available: <http://www.ci.ceres.ca.us/CeresAreaTransit/CAT-Schedule7-2013.pdf>. Accessed: July 10, 2014.
- City of Ceres. 2014. *Ceres Area Transit System Route Map*. Available: <http://www.ci.ceres.ca.us/CeresAreaTransit/CAT-SystemMap2014.pdf>. Accessed: July 10, 2014.
- City of Modesto. 2009a. *Modesto Area Express Bike-N-Bus*. Available: <http://www.modestoareaexpress.com/bikes/>. Accessed: July 10, 2014.
- City of Modesto. 2009b. *Modesto Area Express: ACE, Amtrak, BART*. Available: <http://www.modestoareaexpress.com/commuter/>. Accessed: July 10, 2014.
- City of Modesto. 2009c. *Modesto Area Express: Route 42*. Available: [http://www.modestoareaexpress.com/routes/route\\_42.aspx](http://www.modestoareaexpress.com/routes/route_42.aspx). Accessed: July 10, 2014.
- City of Modesto. 2014. *Modesto Area Express System Route Map*. July 2014. Available: <http://www.modestoareaexpress.com/forms/pdfs/system%20route%20map%200714d.pdf>. Accessed: July 10, 2014.
- Emergency Services Consulting. 2007. *Stanislaus LAFCO Countywide Fire Services Municipal Service Review*. Final Report. March 2007. Prepared for Stanislaus Local Agency Formation Commission. Available: <http://www.stanislauslafco.org/info/FireMSR.htm>. Accessed: August 26, 2014.
- San Joaquin Valley Air Pollution Control District. 2012. *Ambient Air Quality Standards & Valley Attainment Status*. Available: <http://www.valleyair.org/aqinfo/attainment.htm>. Accessed: January 22, 2015.
- San Joaquin Valley Air Pollution Control District. 2014a. *Air Quality in the San Joaquin Valley*. Available: <http://www.valleyair.org/kids/docs/Generalpptforwebsite-2014.pdf>. Accessed: January 22, 2015.
- San Joaquin Valley Air Pollution Control District. 2014b. *Report to the Community, 2013–14 Edition*. Available: <http://www.valleyair.org/2013-14-AnnualReport.pdf>. Accessed: January 22, 2015.
- Stanislaus Council of Governments. 2013. *Stanislaus County Non-Motorized Facilities Master Plan*. Draft. Available: <http://www.stancog.org/pdf/2013-draft-non-motorized-plan.pdf>. Accessed: May 8, 2015.
- Stanislaus Council of Governments. 2014. *2014 Regional Transportation Plan / Sustainable Communities Strategy, Stanislaus County*. June 2014. Available: <http://www.stancog.org/pdf/rtp/final-2014-rtpscs.pdf>. Accessed: December 3, 2014.
- Stanislaus County. 2012. *Stanislaus County General Plan Housing Element 2009-2014*. Adopted August 28, 2012.
- Stanislaus County. 2014a. *Solid Waste Management*. Available: <http://www.stancounty.com/ER/solid-waste-ordinance.shtm>. Accessed: November 18, 2014.

- Stanislaus County. 2014b. *Solid Waste Management Franchise Area Map*. Available: <http://www.stancounty.com/ER/pdf/rates/franchiseareamap.pdf>. Accessed: November 18, 2014.
- Stanislaus County. 2014c. *Landfill Division: Fink Road Sanitary Landfill*. Available: <http://www.stancounty.com/ER/landfill-division.shtm>. Accessed: November 18, 2014.
- Stanislaus County. 2014d. *Zoning Districts*. Available: <http://www.stancounty.com/Planning/pl/zoning-ordinance.shtm>. Accessed: November 20, 2014.
- Stanislaus County. No date. *Stanislaus County General Plan Draft Circulation Element*. Available: <http://www.stancounty.com/planning/pl/act-proj/gpupdate/ch2-circulation.pdf>. Accessed: November 20, 2015.
- Stanislaus County. No Date. *Community Parks, Facilities, and Fishing Accesses*. Available: <http://www.stancounty.com/er/parks/pdf/community-parks-brochure.pdf>. Accessed: December 10, 2014.
- Stanislaus County Health Services Agency. 2013. *2013 Stanislaus County Community Health Assessment*.
- Stanislaus County Sheriff's Department. 2014. *Operations Division*. Available: <http://www.scsdonline.com/operations-division/>. Accessed: November 21, 2014.
- Stanislaus Local Agency Formation Commission. 2010. *Municipal Service Review and Sphere of Influence Update for the County Service Areas within Stanislaus County*. Available: <http://www.stanislauslafco.org/info/PDF/MSR/Districts/CSAs.pdf>. Accessed: October 1, 2014.
- Stanislaus Regional Transit. 2014a. *System Maps and Quick Guide*. Available: [http://www.srt.org/start\\_system\\_maps2.html](http://www.srt.org/start_system_maps2.html). Accessed: July 10, 2014.
- Stanislaus Regional Transit. 2014b. *Stanislaus Regional Transit – Route 40*. Available: [http://www.srt.org/route\\_40.html](http://www.srt.org/route_40.html). Accessed: July 10, 2014.
- Stanislaus Regional Transit. 2014c. *Customer Service and Information/Transit Center*. Available: [http://www.srt.org/CustS\\_TC\\_Hours.html](http://www.srt.org/CustS_TC_Hours.html). Accessed: July 10, 2014.
- United States Census Bureau. 1994. *Geographic Areas Reference Manual*. Available: <https://www.census.gov/geo/reference/garm.html>. Accessed: December 8, 2014.
- United States Census Bureau. 2013a. *American Fact Finder DP-1, Profile of General Population and Housing Characteristics 2010, Cowan CDP, California*. Available: <http://factfinder.census.gov/faces/nav/jsf/pages/inex.xhtml>. Accessed: July 10, 2014.
- United States Census Bureau. 2013b. *American Fact Finder DP03, Selected Economic Characteristics, 2009-2013 American Community Survey 5-Year Estimates, Cowan CDP, California*. Available: <http://factfinder.census.gov/faces/nav/jsf/pages/inex.xhtml>. Accessed: July 10, 2014.

## 2.2 Crows Landing

### 2.2.1 General Characteristics and Demographics

Crows Landing is an unincorporated community located in southwest Stanislaus County 6 miles southeast of the city of Patterson and 13 miles southwest of the city of Turlock. The community of Crows Landing is within the approximately 2,030-acre Crows Landing CDP and had a 2010 census population of 355 people in 121 households. The median annual household income in California was \$60,190 in 2013; it was \$29,141 in Crows Landing (United States Census Bureau 2013a, 2013b). With 41% of its housing units in need of rehabilitation, Crows Landing ranks sixth among unincorporated communities in the county for percentage of housing units in need of rehabilitation (Stanislaus County 2012). At approximately 2,030 acres, the Crows Landing CDP occupies a much larger area than the 86-acre area identified as the Crows Landing DUC and encompasses approximately 1,944 acres of agricultural lands surrounding the DUC, particularly to the north, west, and south.

The Crows Landing DUC is roughly bound by 4<sup>th</sup> Street on the northwest, E Street and Armstrong Road on the northeast, Fink Road on the south, and agricultural lands and Bonita Avenue on the west. SR 33 and the Union Pacific Railroad tracks bisect the community in a northwest-southeast direction. In addition to the residential uses, a range of commercial and public uses are present in Crows Landing. The community includes agricultural packing and shipping operations and a variety of commercial uses clustered along and near SR 33 and the Union Pacific Railroad tracks, as well as a fire station, an elementary school, and a United States Post Office. Crows Landing is surrounded by agricultural land and accompanying agriculture-related residences. Residential uses in Crows Landing consist of single-family residential units (Stanislaus County 2012). All of the land immediately surrounding the Crows Landing DUC is zoned General Agriculture, with a 40-acre minimum parcel size (A-2-40) (Stanislaus County 2014d). These agricultural lands are identified by the California Department of Conservation's Important Farmlands Inventory as prime farmland (California Department of Conservation 2014); much of this area, including land adjacent to the DUC, is also under Williamson Act contract (California Department of Conservation 2012). These agricultural lands neither support the requisite level of existing development for consideration under SB 244 nor are likely to develop; therefore, they are not included as part of the Crows Landing community studied for SB 244 purposes. The former Crows Landing airfield, proposed for development as the Crows Landing Business Industrial Park with a general aviation airport, is located approximately 1.5 miles to the west.

The General Plan's Housing Element identifies Crows Landing as a Residential Development Potential Study Area, noting that Crows Landing has the potential to accommodate three more single-family dwelling units (Stanislaus County 2012). Existing infrastructure and services for the Crows Landing DUC are described below.

### 2.2.2 Infrastructure, Utilities, and Services

Infrastructure, utilities, and services considered for the Crows Landing DUC are presented in Figure 2-2, *Crows Landing Disadvantaged Unincorporated Community*, and include transportation facilities and services including roads, sidewalks, street lighting, and bus stops/service; water, wastewater, and storm drainage systems; solid waste disposal; public safety services such as law enforcement and fire protection; and access to community amenities and services such as schools,

parks, and grocery stores. Data associated with chronic health conditions and air quality are described at a regional level because they are not available for the Crows Landing DUC specifically.

## 2.2.3 Transportation Facilities and Services

Transportation infrastructure in Crows Landing consists of public highways and roads, railroad tracks, and StaRT bus service. Major north-south highways serving western Stanislaus County include Interstate 5 (I-5) and SR 33. Crows Landing lies approximately 3 miles east of I-5 and is bisected by SR 33 and the Union Pacific Railroad tracks. SR 33 is a two-lane undivided highway through Crows Landing, with a four-way stop at its intersection with Fink Road; the County General Plan classifies SR 33 as a four-lane expressway, a category of road intended to move high volumes of people and goods between urban areas within the county at higher speeds (Stanislaus County 2006). (Stanislaus Council of Governments 2014). Fink Road is also currently characterized as a two-lane major road and classified by the County General Plan as a four-lane expressway (Stanislaus Council of Governments 2014; Stanislaus County 2006). With the exception of SR 33 and Fink Road, all remaining roads within Crows Landing are presently two-lane local roads and are expected to remain as such (Stanislaus Council of Governments 2014; Stanislaus County 2006). Other than a short segment of sidewalk on the west side of SR 33 between 4<sup>th</sup> and 6<sup>th</sup> Streets, no sidewalks, curbs, or gutters are present on the roadways in and around Crows Landing (Stanislaus County 2012). Street lights are present along SR 33 and parts of 5<sup>th</sup> Street and Fink Road. The Union Pacific railroad tracks extend north-south immediately east of Crows Landing.

Fixed-route bus service on StaRT Route 45 West connects Crows Landing to Gustine, Newman, and Patterson (Stanislaus Regional Transit 2014a). Buses run on Route 45 West Monday–Friday from 5:30 a.m. to 9:26 p.m., providing eight round trips, and on Saturdays from 5:45 a.m. to 8:39 p.m., providing six round trips (Stanislaus Regional Transit 2014a). From the Patterson Transfer Location at Veteran’s Memorial Park, passengers can transfer to buses on Route 45 East, which travels between Patterson and Turlock, or to Route 40, which connects to Westley, Grayson, and Modesto (Stanislaus Regional Transit 2014b). From Modesto’s Downtown Transportation Center, riders can transfer and connect to the Modesto Amtrak station, the ACE train station in Lathrop, and the Dublin BART station (Stanislaus Regional Transit 2014b; City of Modesto 2009).

Crows Landing has two StaRT bus stops, one northbound and one southbound, on SR 33 near 5<sup>th</sup> Street (Stanislaus Regional Transit 2014a). In addition, Crows Landing falls within the Newman Dial-a-Ride service area, which comprises the cities of Newman and Patterson in addition to the communities of Crows Landing and Gustine (Stanislaus Regional Transit 2014b). Newman Dial-a-Ride provides bus service three times per day, Monday–Saturday (Stanislaus Regional Transit 2014b).

## 2.2.4 Water, Wastewater, and Stormwater Drainage Systems

Crows Landing receives all of its domestic water for residential and commercial use from ground water supplied by the Crows Landing CSD. The Crows Landing CSD obtains water through its two groundwater wells (Stanislaus Local Agency Formation Commission 2014). The Crows Landing CSD water supply system is operating at capacity and has a history of water supply problems, caused in large part by the age of its infrastructure (Stanislaus Local Agency Formation Commission 2014). Most of the Crows Landing CSD’s water supply flows through an aging system of small pipelines that lose pressure under heavy consumptive demands (Stanislaus Local Agency Formation Commission



Path: K:\Projects\_1\County\_of\_Stanislaus\00203\_10\_DAC\mapdoc\IDUCs\Fig2\_ServicesA.mxd; User: 19393; Date: 6/9/2015

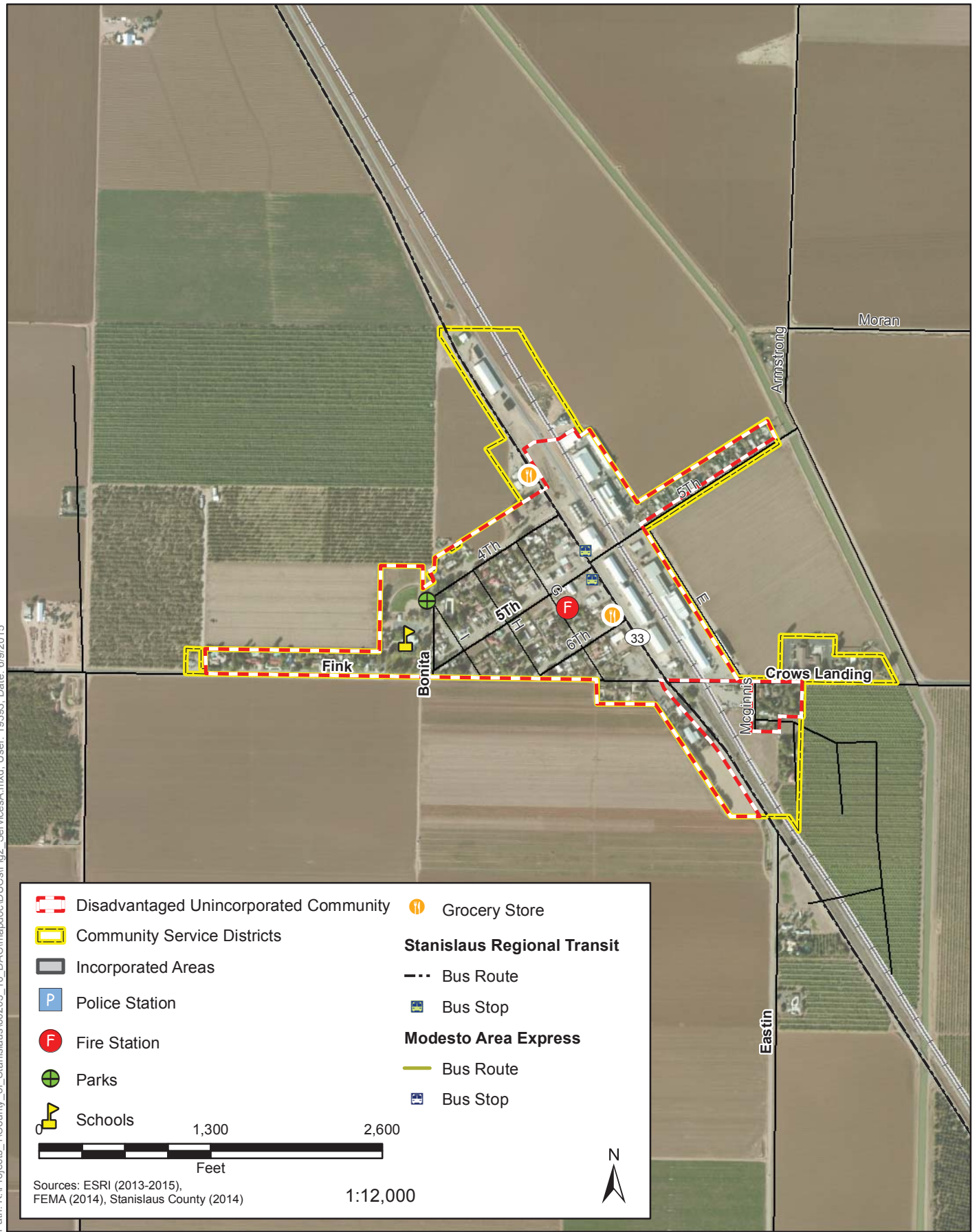

	Disadvantaged Unincorporated Community		Grocery Store
	Community Service Districts	<b>Stanislaus Regional Transit</b>	
	Incorporated Areas		Bus Route
	Police Station		Bus Stop
	Fire Station	<b>Modesto Area Express</b>	
	Parks		Bus Route
	Schools		Bus Stop

1,300      2,600  
Feet

Sources: ESRI (2013-2015), FEMA (2014), Stanislaus County (2014)      1:12,000



**Figure 2-2**  
**Crows Landing Disadvantaged Unincorporated Community**

***THIS PAGE INTENTIONALLY LEFT BLANK***

2014). The Crows Landing CSD recently received a \$20,000 grant from the Stanislaus County Community Development Fund toward the repair of one of its wells that was found to have several large holes (Stanislaus County Local Agency Formation Commission 2014).

Wastewater in Crows Landing is processed through individual private septic systems, and no storm drainage system is present in the community (Stanislaus Local Agency Formation Commission 2014). Drainage consists primarily of roadside percolation, with no pipelines or detention ponds (Stanislaus County 2004).

## 2.2.5 Solid Waste Disposal

Stanislaus County contracts with four franchised solid waste collection companies, Bertolotti Disposal, Gilton Solid Waste, Modesto Disposal/Waste Management, and Turlock Scavenger, for residential and commercial garbage collection service in the unincorporated area (Stanislaus County 2014a). Crows Landing falls within County-designated Franchise Area 1, served by Bertolotti Disposal (Stanislaus County 2014b). Besides providing solid waste and recyclables collection services to Franchise Area 1, Bertolotti Disposal operates a transfer station, open to the public Mondays through Saturdays, on Flamingo Road in Ceres. Additionally, Stanislaus County's Fink Road Sanitary Landfill, a Class III landfill for nonhazardous municipal solid waste, is operated by the County's Department of Environmental Resources and is open Monday–Saturday to private citizens, school districts, businesses, and local agencies for individual disposal of solid waste (Stanislaus County 2014c).

## 2.2.6 Law Enforcement and Fire Protection

Law enforcement services for Crows Landing, as for the rest of unincorporated Stanislaus County and four contract cities, are provided by the Stanislaus County Sheriff's Department. The nearest sheriff's station to Crows Landing is the main station, approximately 16 miles northeast at 250 East Hackett Road in Ceres. In addition, the Patterson police station, located approximately 6.5 miles northwest of Crows Landing in the city of Patterson, is staffed by the Stanislaus County Sheriff's Department, which provides contract police services to Patterson under the title of Patterson Police Services (Stanislaus County Sheriff's Department 2014). The Newman police station is 6 miles southeast of Crows Landing. Although the Sheriff's Department remains the designated law enforcement agency for unincorporated areas of the county, in practice, the County Sheriff's Department and Newman Police Department provide each another with frequent mutual aid and back-up services (Stanislaus County Sheriff's Department 2014).

The operations division of the Sheriff's Department provides law enforcement services to over 200,000 people in a 1,521-square-mile area (Stanislaus County Sheriff's Department 2014). Two units—patrol and investigations—comprise the Sheriff's Department operations division. The patrol unit responds to calls for assistance, investigates crime, makes arrests, and performs preventive patrol services (Stanislaus County Sheriff's Department 2014). The investigations unit follows up reports of major crimes, collects and prepares evidence for trials, apprehends offenders, and recovers stolen property (Stanislaus County Sheriff's Department 2014).

The crime rates presented below were compiled by AGS using the primary reporting categories from the FBI 2005 – 2010 Uniform Crime Report databases along with preliminary 2011 release data and census data related to socioeconomic characteristics. The crimes are divided into two main categories, personal crimes (murder, rape, robbery, and assault) and property crimes (burglary,

larceny, and motor vehicle theft). These crime rates are based on a comparison of the average local crime rate to the national average for the same crime, with a crime index of 100 considered average; scores above 100 are therefore considered greater, or worse, than average. For example, a score of 130 would represent a crime rate 30% greater than the national average for that type of crime. These crime rates are unweighted (i.e., a murder and a theft carry the same weight for calculation purposes), and are tracked at the census block group level and above, which may not correspond precisely to the DUC boundaries. Census blocks are the smallest geographic area for which the United States Census Bureau collects and tabulates data; a set of these constitutes a census block group. Census blocks vary widely in geographic size, and are generally smaller in urban areas and progressively larger in suburban, rural, or remote areas; a given block group is larger in area and population than the individual census blocks of which it is made, and generally contains between 600 and 3,000 people (United States Census Bureau 1994). Crows Landing DUC falls within two census block groups; the primarily residential area north of Fink Road and west of SR 33 falls within block group 060990034.001 and the area southeast of Fink Road/SR 33 falls within block group 060990034.002.

The overall personal crime indices for the two census block groups comprising Crows Landing are 118 and 83, and the property crime indices are 55 and 82. These rates mean that personal crimes occur at rates 18% higher than the national average in the main area of Crows Landing, north of Fink Road, and 83% of the national average for the small area of Crows Landing southeast of Fink Road and SR 33. Property crimes occur at a rate of 55% and 82% of the national average for these two block groups. The general and individual crime indices for these categories are shown in Table 2-5 below.

**Table 2-5. Crows Landing Crime Indices**

Block Group	Personal Crime		Block Group	Property Crime	
	060990034.001	060990034.002		060990034.001	060990034.002
Personal Crime Index	118	83	Property Crime Index	55	82
Murder	160	208	Burglary	86	163
Rape	136	49	Larceny	63	88
Robbery	80	44	Motor Vehicle Theft	41	12
Assault	85	32			

Source: Applied Geographic Solutions and Atlas Publishing 2012.

The West Stanislaus County FPD provides fire protection, emergency, and rescue services to the Crows Landing area, as well as to Grayson, Diablo Grande, and Westley (Emergency Services Consulting 2007). District-wide, 5 full-time firefighters per shift and 100 volunteers staff the West Stanislaus County FPD (Emergency Services Consulting 2007). The West Stanislaus County FPD's Fire Station No. 6 is located within Crows Landing at 22012 G Street and houses two engines (West Stanislaus County Fire Protection District 2014).

A fire department's ability to meet the fire protection needs of its service area is typically evaluated by the Insurance Services Office (ISO), a private organization that assesses risks, including fire protection, for insurance purposes. The ISO considers a variety of factors, including a district's fire-fighting apparatus, staffing, training, location, and water supply, to rate fire departments on a scale

from 1 (best fire protection possible) to 10 (no fire protection). The ISO rating therefore reflects a fire department's ability to protect the residents and businesses within its service area from fire. The West Stanislaus County FPD carries an ISO rating of 4 (West Stanislaus Fire Protection District 2015).

## 2.2.7 Schools and Community Amenities

Crows Landing is within the Newman-Crows Landing Unified School District, which in 9 schools serves 2,887 students in grades K–12 (California Department of Education 2014b; Stanislaus County Office of Education 2009). One school, Bonita Elementary School, is located in Crows Landing. Bonita Elementary School serves 156 students in grades K–5 (California Department of Education 2014a). The nearest middle school to Crows Landing is Yolo Middle School, 7 miles south in the city of Newman. Yolo Middle School serves 646 students in grades 6–8 (California Department of Education 2014d). The closest high school is also in Newman, Orestimba High School, serving 768 students in grades 9–12, is 6 miles south of Crows Landing (California Department of Education 2014c).

Crows Landing has one public park, the 1-acre Bonita Park and Pool facility, located near the northwestern edge of the community across the street from Bonita Elementary School. Bonita Park features picnic tables, a swimming pool, and an informal play area; however, the Bonita Park swimming pool is closed and unavailable for public use pending future repairs (Stanislaus County n.d.). In addition, Bonita Elementary School includes a playground, outdoor basketball courts, and a baseball/softball field.

Two small convenience markets are located in Crows Landing. Las Palmas Market & Deli is located at the north end of Crows Landing on SR 33 and the Qwik-Serve Market #2 is also on SR 33 at 6<sup>th</sup> Street. The nearest full-service supermarkets are Save Mart, approximately 6 miles northwest in Patterson, and Nob Hill Foods, about 6.5 miles south in Newman.

## 2.2.8 Air Quality and Chronic Health Conditions

Stanislaus County is within the northern part of the eight-county SJVAPCD, the regional public health agency responsible for air quality management in those eight counties. SJVAPCD cites several factors that contribute to the valley's air quality challenges, including high rates of chronic poverty and unemployment coupled with a high population growth rate, the presence of major transportation corridors, and topographic features such as the surrounding mountains combined with the area's meteorological conditions (San Joaquin Valley Air Pollution Control District 2014a). SJVAPCD notes that ozone, PM10, and PM2.5, are of special concern, causing or exacerbating a variety of health conditions (San Joaquin Valley Air Pollution Control District 2014a). The presence of PM2.5, primarily a winter condition, triggers heart attacks, asthma, bronchitis, and respiratory infections, and has a strong correlation with hospital admissions and deaths (San Joaquin Valley Air Pollution Control District 2014a).

GHGs are not a criteria air pollutant and do not directly affect human health. GHG emissions are largely the result of combustion, decay and digestive processes, and emissions of industrial gases with high climate change potential. Unlike criteria pollutants such as carbon monoxide, PM10, PM2.5, and ozone, GHGs do not collect within a specific area or air basin. Their harm is done at a global level through the effect of increased concentrations of GHGs in Earth's atmosphere.

Worldwide concern over GHG emissions is based on the climate change that they are causing by altering the way in which Earth's atmosphere traps solar radiation as heat. The adverse effects of global climate change include rising sea levels, changes in habitat conditions for plants and animals, increased potential for wildfires, more severe weather extremes, and a reduction in California's winter snow pack, among others. Through the impetus of AB 32 (California Global Warming Solutions Act of 2006) and other legislation, California has undertaken a statewide program of reducing GHG emissions to 1990 levels by 2020 in order to slow the rate of global climate change.

Climate change can have an indirect effect on human health in Stanislaus County to the extent that it results in warmer summer temperatures that facilitate ozone formation and exacerbate heat-related stress among outdoor workers, the elderly, small children, and the infirm. The amount of GHGs emitted within the Crows Landing DUC is not atypical for a small, rural community.

SJVAPCD operates 36 air monitoring sites within its eight-county air basin. Of these, two air quality stations, one in Modesto and another in Turlock, monitor air quality within Stanislaus County. The Turlock monitoring site is the closest to Crows Landing, approximately 14.3 miles northeast of the community. Table 2-6 shows the SJVAB's current air quality attainment status for state and federal criteria pollutants (San Joaquin Valley Air Pollution Control District 2012).

**Table 2-6. San Joaquin Valley Air Basin Air Quality Attainment Status**

Pollutant	Designation/Classification	
	Federal Standards	State Standards
Ozone—1-hour	No Federal Standard <sup>a</sup>	Nonattainment/Severe
Ozone—8-hour	Nonattainment/Extreme <sup>b</sup>	Nonattainment
PM 10	Attainment <sup>c</sup>	Nonattainment
PM 2.5	Nonattainment <sup>d</sup>	Nonattainment
Carbon monoxide	Attainment/Unclassified	Attainment/Unclassified
Nitrogen dioxide	Attainment/Unclassified	Attainment
Sulfur dioxide	Attainment/Unclassified	Attainment
Lead (particulate)	No Designation/Classification	Attainment
Hydrogen sulfide	No Federal Standard	Unclassified
Sulfates	No Federal Standard	Attainment
Visibility reducing particles	No Federal Standard	Unclassified
Vinyl chloride	No Federal Standard	Attainment

Source: San Joaquin Valley Air Pollution Control District 2012.

- <sup>a</sup> Effective June 15, 2005, the U.S. Environmental Protection Agency (EPA) revoked the federal 1-hour ozone standard, including associated designations and classifications. EPA had previously classified the San Joaquin Valley air basin (SJVAB) as extreme nonattainment for this standard. EPA approved the 2004 Extreme Ozone Attainment Demonstration Plan on March 8, 2010 (effective April 7, 2010). Many applicable requirements for extreme 1-hour ozone nonattainment areas continue to apply to the SJVAB.
- <sup>b</sup> Though the SJVAB was initially classified as serious nonattainment for the 1997 8-hour ozone standard, EPA approved SJVAB reclassification to extreme nonattainment in the Federal Register on May 5, 2010 (effective June 4, 2010).
- <sup>c</sup> On September 25, 2008, EPA redesignated the SJVAB to attainment for the PM10 National Ambient Air Quality Standard (NAAQS) and approved the PM10 Maintenance Plan.
- <sup>d</sup> The SJVAB is designated nonattainment for the 1997 PM2.5 NAAQS. EPA designated the SJVAB as nonattainment for the 2006 PM2.5 NAAQS on November 13, 2009 (effective December 14, 2009).

Over the past decade, ozone levels have been trending downward within the SJVAB and, in 2013, for the first time on record, the air basin overall had zero violations of the federal hourly ozone standard, compared to 281 violations in 1996 (San Joaquin Valley Air Pollution Control District 2014b). At the same time, PM2.5 and PM10 levels have fluctuated with no clear upward or downward trend (California Air Resources Board 2015). Table 2-7 presents the number of days in which Stanislaus County ozone, PM2.5, and PM10 levels exceeded state and federal air quality standards in 2013 (California Air Resources Board 2015).

**Table 2-7. Stanislaus County Days in Exceedance of State and Federal Air Quality Standards, 2013**

Monitoring Site	Ozone			PM 2.5	PM 10
	# Days > State 1-Hr Standard	# Days > National '08 8-Hr Standard	# Days > State 8-Hr Standard	Est Days > National 24-Hr Standard	Est Days > State 24-Hr Standard
Modesto 14th St.	0	2	13	37.6	57.7
Turlock S. Minaret St.	1	14	24	40.3	73.7

Source: California Air Resources Board 2015.

The 2013 CHA, prepared by the Stanislaus County Health Services Agency, presents data about the health and well-being of Stanislaus County residents, including information on the burden of five major chronic diseases—hypertension, heart disease, stroke, diabetes and asthma—and the environmental and behavioral factors that influence their prevalence. Primary environmental factors identified in the CHA as contributing to these chronic health conditions are air quality and retail food environment; behavioral factors include diet, fast food consumption, fruit and vegetable consumption, quality of clinical care, physical activity, obesity, and tobacco use (Stanislaus County Health Services Agency 2013). As measured in 2007, Stanislaus County has the second worst retail food environment in California, with 5.48 fast-food purveyors and convenience stores for every grocery store or produce vendor near residences, compared to 4.48 statewide, and a high rate of fast food consumption in the low income population (Stanislaus County Health Services Agency 2013). The county also has the highest prevalence of obesity in the state (31.5% compared to 21.2% statewide), particularly among males, and a higher percentage of smokers than the California average (Stanislaus County Health Services Agency 2013).

The CHA presents countywide data and also divides Stanislaus County into nine geographic regions, shown in Table 2-8 below. Crows Landing falls within the west side region identified in Table 2-8.

**Table 2-8. Community Health Assessment of Stanislaus County Geographic Regions**

Region	Communities
Central	Modesto (parts) and outlying areas with ZIP codes 95350, 95355, 95357, and 95358
East Central	Airport Neighborhood and East Modesto (parts) with ZIP code 95354
Southeast Side	Denair, Empire, Hughson, Hickman, La Grange, Waterford with ZIP codes 95316, 95319, 95326, 95323, 95329, and 95386
Northeast Side	Knights Ferry, Valley Home, Oakdale, Riverbank with ZIP codes 95230, 95361, and 95367
North Side	Del Rio, Salida and Modesto (parts) with ZIP codes 95356 and 95368
Southwest Central	West Modesto and South Modesto with ZIP code 95351
West Side	Crows Landing, Grayson, Newman, Patterson with ZIP codes 95313, 95360, 95363, 95385, and 95387
South Central	Ceres, Keyes with ZIP codes 95307 and 95328
South Side	Turlock with ZIP codes 95380 and 95382

Source: Stanislaus County Health Services Agency 2013:Table 2.



Chronic health conditions of concern within Stanislaus County include hypertension, heart disease, stroke, diabetes and asthma. According to the CHA, the percentage of Stanislaus adults diagnosed with high blood pressure increased 31.2% between 2001 and 2009, and surpassed the percentage of California adults diagnosed with high blood pressure use. As of 2009, approximately 30.7% of Stanislaus County adults were diagnosed with hypertension, compared to 26.2% statewide. Among Stanislaus County's nine regions, the west side, including Crows Landing, has the lowest rate of hypertension-related emergency room visits, ranks fifth for hypertension-related hospitalizations, and has the second-lowest hypertension-related mortality rate (Stanislaus County Health Services Agency 2013).

The CHA notes that in 2009, 5% of Stanislaus County adults had been diagnosed with heart disease, compared to 5.9% statewide and 12% of adults nationwide. Stanislaus County's west side has the second-lowest rate of heart disease-related emergency room visits among the county's nine regions, the lowest rate of heart disease-related hospitalizations, and the fourth-highest mortality rate (Stanislaus County Health Services Agency 2013).

The CHA indicates that the California Health Interview Survey, on which it relies for some data, has not consistently tracked either the overall prevalence of cancer or the rates of individual types of cancer; data for cancer rates is therefore less current than for other, more closely tracked, conditions. Although the percentage of Stanislaus County adults diagnosed with cancer has increased from 7.4% in 2001 to 8.5% in 2005, it remains lower than the statewide rate. However, at a rate of approximately 21.4% of all deaths annually, cancer is the second most common cause of death in Stanislaus County. The west side of Stanislaus County ranks seventh (third-lowest) among the nine regions for cancer-related emergency room visits, has the lowest rate of cancer-related hospitalizations, and the highest rate of cancer-related mortality (Stanislaus County Health Services Agency 2013).

Diabetes, according to the CHA, affects 8.3% of the United States population and is the seventh leading cause of death nationwide. Within California, from 2001 to 2007, the percentage of people diagnosed with diabetes increased from 6.2% to 8.5%, a 37% increase. Trends in Stanislaus County are consistent with the statewide increase; in 2009, 7.6% of adults in Stanislaus County had been diagnosed with diabetes. While the prevalence of diabetes was lower in Stanislaus County than California, in 2011, Stanislaus County had higher hospitalization rates than California for four primary indicators of diabetes management, including hospitalization for short-term complications, long-term complications, lower-extremity amputation, and uncontrolled diabetes (Stanislaus County Health Services Agency 2013). Among Stanislaus County's nine regions, the west side has the lowest rate of diabetes-related emergency room visits, the third-lowest rate of hospitalizations, and the highest rate of diabetes-related mortality (Stanislaus County Health Services Agency 2013).

According to the CHA, in 2009 the percentage of Stanislaus County adults diagnosed with asthma was 21.8%, compared to 13.5% of the adult population statewide. The west side region has Stanislaus County's second-lowest rate of asthma-related emergency room visits and hospitalizations among the county's nine regions (Stanislaus County Health Services Agency 2013). Due to the low asthma-related death rate, the CHA does not track or rank asthma-related mortality.

The CHA also uses LEB as a measure of quality of life within Stanislaus County and each of its nine regions. LEB is defined as the number of years a newborn infant is projected to live if mortality patterns at the time of its birth were to remain the same throughout its life. The LEB for Stanislaus County is calculated to be 77.2 years, 1.7 years less than the nationwide LEB of 78.9. The LEBs

within the nine Stanislaus County regions range from a high of 80.27 years to a low of 75.01 years; the west side region ranks third-highest among these, with a LEB of 79.58 years (Stanislaus County Health Services Agency 2013).

## 2.2.9 References

- Applied Geographic Solutions and Atlas Publisher. 2012. Crime Index for the U.S. Retrieved through ArcGIS. Available: [http://megacity.esri.com/ArcGIS/rest/services/Demographics/USA\\_CrimeIndex/MapServer](http://megacity.esri.com/ArcGIS/rest/services/Demographics/USA_CrimeIndex/MapServer). Accessed: 2012.
- California Air Resources Board. 2015. *Select 8 Summary*. Available: <http://www.arb.ca.gov/adam/select8/sc8start.php>. Accessed: January 22, 2015.
- California Department of Conservation. 2012. Division of Land Resource Protection. *Stanislaus County Williamson Act FY 2010/2011, Sheet 2 of 2*. Available: [ftp://ftp.consrv.ca.gov/pub/dlrp/wa/stanislaus\\_south\\_10\\_11\\_WA.pdf](ftp://ftp.consrv.ca.gov/pub/dlrp/wa/stanislaus_south_10_11_WA.pdf). Accessed: January 16, 2015.
- California Department of Conservation. 2014. Division of Land Resource Protection. *Rural Land Mapping Edition, Stanislaus County Important Farmland 2012, Sheet 2 of 2*. Available: [ftp://ftp.consrv.ca.gov/pub/dlrp/FMMP/pdf/2012/sta12\\_so.pdf](ftp://ftp.consrv.ca.gov/pub/dlrp/FMMP/pdf/2012/sta12_so.pdf). Accessed: January 16, 2015.
- California Department of Education. 2014a. *Bonita Elementary School Profile: Fiscal Year 2013–14*. Available: [http://www.ed-data.k12.ca.us/App\\_Resx/EdDataClassic/fsTwoPanel.aspx?#!bottom=/layouts/EdDataClassic/profile.asp?tab=0&level=07&ReportNumber=16&County=50&fyr=1314&District=73601&School=0108076](http://www.ed-data.k12.ca.us/App_Resx/EdDataClassic/fsTwoPanel.aspx?#!bottom=/layouts/EdDataClassic/profile.asp?tab=0&level=07&ReportNumber=16&County=50&fyr=1314&District=73601&School=0108076). Accessed: November 19, 2014.
- California Department of Education. 2014b. *Newman-Crows Landing School District Profile: Fiscal Year 2013–14*. Available: [http://www.ed-data.k12.ca.us/App\\_Resx/EdDataClassic/fsTwoPanel.aspx?#!bottom=/layouts/EdDataClassic/profile.asp?Tab=1&level=06&reportnumber=16](http://www.ed-data.k12.ca.us/App_Resx/EdDataClassic/fsTwoPanel.aspx?#!bottom=/layouts/EdDataClassic/profile.asp?Tab=1&level=06&reportnumber=16). Accessed: November 19, 2014.
- California Department of Education. 2014c. *Orestimba High School Profile: Fiscal Year 2013–14*. Available: [http://www.ed-data.k12.ca.us/App\\_Resx/EdDataClassic/fsTwoPanel.aspx?#!bottom=/layouts/EdDataClassic/profile.asp?tab=0&level=07&ReportNumber=16&County=50&fyr=1314&District=73601&School=5035902](http://www.ed-data.k12.ca.us/App_Resx/EdDataClassic/fsTwoPanel.aspx?#!bottom=/layouts/EdDataClassic/profile.asp?tab=0&level=07&ReportNumber=16&County=50&fyr=1314&District=73601&School=5035902). Accessed: November 19, 2014.
- California Department of Education. 2014d. *Yolo Junior High School Profile: Fiscal Year 2013–14*. Available: [http://www.ed-data.k12.ca.us/App\\_Resx/EdDataClassic/fsTwoPanel.aspx?#!bottom=/layouts/EdDataClassic/profile.asp?tab=0&level=07&ReportNumber=16&County=50&fyr=1314&District=73601&School=6025761](http://www.ed-data.k12.ca.us/App_Resx/EdDataClassic/fsTwoPanel.aspx?#!bottom=/layouts/EdDataClassic/profile.asp?tab=0&level=07&ReportNumber=16&County=50&fyr=1314&District=73601&School=6025761). Accessed: November 19, 2014.
- City of Modesto. 2009. *Modesto Area Express: ACE, Amtrak, BART*. Available: <http://www.modestoareaexpress.com/commuter/>. Accessed: July 10, 2014.

- Emergency Services Consulting. 2007. *Stanislaus LAFCO Countywide Fire Services Municipal Service Review*. Final Report. March 2007. Prepared for Stanislaus Local Agency Formation Commission. Available: <http://www.stanislauslafco.org/info/FireMSR.htm>. Accessed: August 26, 2014.
- San Joaquin Valley Air Pollution Control District. 2012. *Ambient Air Quality Standards & Valley Attainment Status*. Available: <http://www.valleyair.org/aqinfo/attainment.htm>. Accessed: January 22, 2015.
- San Joaquin Valley Air Pollution Control District. 2014a. *Air Quality in the San Joaquin Valley*. Available: <http://www.valleyair.org/kids/docs/Generalpptforwebsite-2014.pdf>. Accessed: January 22, 2015.
- San Joaquin Valley Air Pollution Control District. 2014b. *Report to the Community, 2013–14 Edition*. Available: <http://www.valleyair.org/2013-14-AnnualReport.pdf>. Accessed: January 22, 2015.
- Stanislaus Council of Governments. 2014. *2014 Regional Transportation Plan / Sustainable Communities Strategy, Stanislaus County*. June 2014. Available: <http://www.stancog.org/pdf/rtp/final-2014-rtpscs.pdf>. Accessed: December 3, 2014.
- Stanislaus County. 2004. *Storm Water Management Program for Stanislaus County*. Available: <http://www.stancounty.com/publicworks/storm/pdf/sw-management-plan.pdf>. Accessed: December 10, 2014.
- Stanislaus County. 2006. *Circulation Element of the Stanislaus County General Plan*. Updated April 18, 2006. Available: <http://www.stancounty.com/planning/pl/gp/gp-chapter2.pdf>. Accessed: December 12, 2014.
- Stanislaus County. 2012. *Stanislaus County General Plan Housing Element 2009-2014*. Adopted August 28, 2012.
- Stanislaus County. 2014a. *Solid Waste Management*. Available: <http://www.stancounty.com/ER/solid-waste-ordinance.shtm>. Accessed: November 18, 2014.
- Stanislaus County. 2014b. *Solid Waste Management Franchise Area Map*. Available: <http://www.stancounty.com/ER/pdf/rates/franchiseareamap.pdf>. Accessed: November 18, 2014.
- Stanislaus County. 2014c. *Landfill Division: Fink Road Sanitary Landfill*. Available: <http://www.stancounty.com/ER/landfill-division.shtm>. Accessed: November 18, 2014.
- Stanislaus County. 2014d. *Zoning Districts*. Available: <http://www.stancounty.com/Planning/pl/zoning-ordinance.shtm>. Accessed: November 20, 2014.
- Stanislaus County. No Date. *Community Parks, Facilities, and Fishing Accesses*. Available: <http://www.stancounty.com/er/parks/pdf/community-parks-brochure.pdf>. Accessed: December 10, 2014.
- Stanislaus County Health Services Agency. 2013. *2013 Stanislaus County Community Health Assessment*.
- Stanislaus County Office of Education. 2009. *Newman-Crows Landing School District Map*. Available: [http://www.stancoe.org/scoe/resources/district\\_maps/Newman\\_Crows%20Landing\\_USD.pdf](http://www.stancoe.org/scoe/resources/district_maps/Newman_Crows%20Landing_USD.pdf). Accessed: November 19, 2014.

- Stanislaus County Sheriff's Department. 2014. *Operations Division*. Available: <http://www.scsdonline.com/operations-division/>. Accessed: November 21, 2014.
- Stanislaus Local Agency Formation Commission. 2014. *Municipal Service Review and Sphere Of Influence Update For: Crows Landing, Grayson, and Westley Community Services Districts*. Available: <http://www.stanislauslafco.org/info/PDF/MSR/Districts/CrowsLGraysonWestleyCSD.pdf>. Accessed: December 10, 2014.
- Stanislaus Regional Transit. 2014a. *System Maps and Quick Guide*. Available: [http://www.srt.org/start\\_system\\_maps2.html](http://www.srt.org/start_system_maps2.html). Accessed: December 23, 2014.
- Stanislaus Regional Transit. 2014b. Newman Dial-a-Ride Service Map. Available: <http://www.srt.org/Newman%20Dial-A-Ride%202014-15.pdf>. Accessed: December 23, 2014.
- United States Census Bureau. 1994. *Geographic Areas Reference Manual*. Available: <https://www.census.gov/geo/reference/garm.html>. Accessed: December 8, 2014.
- United States Census Bureau. 2013a. *American Fact Finder DP-1, Profile of General Population and Housing Characteristics 2010, Crows Landing CDP, California*. Available: <http://factfinder.census.gov/faces/nav/jsf/pages/inex.xhtml>. Accessed: July 10, 2014.
- United States Census Bureau. 2013b. *American Fact Finder DP03, Selected Economic Characteristics, 2009-2013 American Community Survey 5-Year Estimates, Crows Landing CDP, California*. Available: <http://factfinder.census.gov/faces/nav/jsf/pages/inex.xhtml>. Accessed: July 10, 2014.
- West Stanislaus Fire Protection District. 2014. *Fire Station 6 – Crows Landing*. Available: <http://www.weststanfire.org/fire-station-6/>. Accessed: November 21, 2014.
- West Stanislaus Fire Protection District. 2015. *ISO Rating Update*. Available: <http://www.weststanfire.org/iso-rating-update/>. Accessed: June 1, 2015.

## 2.3 Grayson

### 2.3.1 General Characteristics and Demographics

Grayson is an unincorporated residential community comprised primarily of single-family residential units located approximately 11 miles southwest of the city of Modesto and 6.5 miles northwest of the city of Patterson. In 2010, Grayson had 280 housing units, 250 of which were occupied (United States Census Bureau 2013a). The community of Grayson is a CDP with a population of approximately 952 people in 250 households. California's median annual income was \$60,190 in 2013; Grayson's median annual household income was \$37,899 (United States Census Bureau 2013a, 2013b). At 1,632 acres, the Grayson CDP occupies a much larger area than the roughly 100-acre area identified as the Grayson DUC, and encompasses approximately 1,532 acres of agricultural lands north of the DUC. The majority of land within the Grayson CDP is categorized by the California Department of Conservation's Important Farmlands Inventory as either prime farmland or nonagricultural and natural vegetation; the remaining small areas consist of grazing land and farmland of local importance (California Department of Conservation 2014); most of this area is not enrolled in the Williamson Act program (California Department of Conservation 2012). Part of the Grayson CDP north of the DUC is zoned Planned Development (PD), however, the PD is expired and use of the area is limited to agricultural use that does not support the requisite level of existing development for consideration under SB 244; therefore, it is not included as part of the Grayson DUC.

The Grayson DUC is roughly bordered by Hito Drive on the north, the San Joaquin River on the east, Grayson Road on the south, and River Road on the west. The community is surrounded on the north, west, and south by agricultural land and scattered agriculture-related structures and residences, and bordered on the eastern side by the San Joaquin River. Adjacent land to the west, south, and east of the Grayson DUC is zoned General Agriculture, with a 40-acre minimum parcel size (A-2-40) (Stanislaus County 2014).

The General Plan's Housing Element identifies Grayson as a Residential Development Potential Study Area and that it has the potential to accommodate 10 more dwelling units (Stanislaus County 2012). Existing infrastructure and services for Grayson are described below.

### 2.3.2 Infrastructure, Utilities, and Services

Infrastructure, utilities, and services considered for the Grayson DUC are presented in Figure 2-3, *Grayson Disadvantaged Unincorporated Community*, and include transportation facilities and services including roads, sidewalks, street lighting, and bus stops/service; water, wastewater, and storm drainage systems; solid waste disposal; public safety services such as law enforcement and fire protection; and access to community amenities and services such as schools, parks, and grocery stores. Data associated with chronic health conditions and air quality are described at a regional level because they are not available specifically for the Grayson DUC.

### 2.3.3 Transportation Facilities and Services

Transportation infrastructure in the Grayson area consists of public highways and roads, and StaRT bus service. Major north-south highways serving western Stanislaus County include I-5 and SR 33. Grayson lies approximately 4.7 miles east of I-5 and 1.3 miles east of SR 33, the Union Pacific

Railroad tracks, and the community of Westley on West Grayson Road. West Grayson Road, which forms the DUC's southern border, is a two-lane major road; all of the roads within Grayson are two-lane local roads (Stanislaus County 2006; Stanislaus Council of Governments 2014). The County General Plan classifies West Grayson Road as a four-lane expressway, intended to move high volumes of people and goods between urban areas within the county (Stanislaus County 2006). Although all streets are paved and most have sidewalks, curbs, and gutters, approximately 40% of the housing units in Grayson lack sidewalks (Stanislaus County 2012).

Fixed-route bus service on StaRT Route 40 connects Grayson to Modesto, Westley, and Patterson (Stanislaus Regional Transit 2014a). StaRT Route 40 provides round trips between Modesto and Patterson; Monday–Friday, there are eight round trips, running approximately every 2 hours from 5:20 a.m. to 9:08 p.m.; on Saturdays, there are five round trips, running every 2 hours and 45 minutes from 8:15 a.m. to 8:12 p.m.; no StaRT buses run on Route 40 on Sundays (Stanislaus Regional Transit 2014b). From the Modesto Downtown Transit Center, passengers can transfer to buses on Route 10 Express to Turlock; Route 15 to Ceres, Keyes, and Turlock; and Route 60 to Riverbank and Oakdale, as well as to the Modesto Amtrak station, the ACE train station in Lathrop, and the Dublin BART station (City of Modesto 2009; Stanislaus Regional Transit 2014c). From the Patterson Transfer Location at Veteran's Memorial Park, passengers can transfer to buses on Route 45 East, which travels between Patterson and Turlock, and Route 45 West, which connects Patterson to Crows Landing, Newman, and Gustine (Stanislaus Regional Transit 2014c). Grayson has two StaRT bus stops, one at Amelia Street and Stakes Road, and another at Laird and Mary Streets (Stanislaus Regional Transit 2014c).

### 2.3.4 Water, Wastewater, and Stormwater Drainage Systems

The City of Modesto provides municipal water service to Grayson through the former Del Este water system; the water is pumped from two groundwater wells in the Grayson area, treated through an ion exchange nitrate treatment system, then stored in a 0.22 million gallon tank prior to distribution (Stanislaus County Local Agency Formation Commission 2014). This approach has reduced nitrate contamination levels such that Grayson's water supply had no recorded water quality violations in 2014 (City of Modesto 2010, 2014). However, the City of Modesto's *2010 Water System Engineer's Report* identifies deficiencies in Grayson's water supply and distribution system. Specific deficiencies include the pumping capacity of the two wells and areas of the distribution system in which minimum water pressure could not be maintained. To remedy the deficiencies, the *Engineer's Report* recommends capital improvement projects, including construction of a new (third) well with a 400 gallon per minute (gpm) pumping capacity; a new backup generator at one of the existing wells; 900 gpm of additional pump capacity at the existing storage tank; repair and replacement of aging infrastructure; and 4,600 feet of upsized distribution pipelines to ensure adequate fire flow (City of Modesto 2010). In 2014, the City of Modesto applied, unsuccessfully, to the California Department of Water Resources for an Expedited Drought Grant to implement these improvements (California Department of Water Resources 2014a, 2014b).

The Grayson CSD provides wastewater and street lighting service to the Grayson DUC. The Grayson CSD's wastewater collection and treatment system has a designed flow capacity of 100,000 gallons per day and is presently operating at capacity (Stanislaus Local Agency Formation Commission 2014).

Path: K:\Projects\_1\County\_of\_Stanslaus\00203\_10\_DAC\mapdoc\DCos\Fig2\_ServicesA.mxd; User: 19393; Date: 6/9/2015

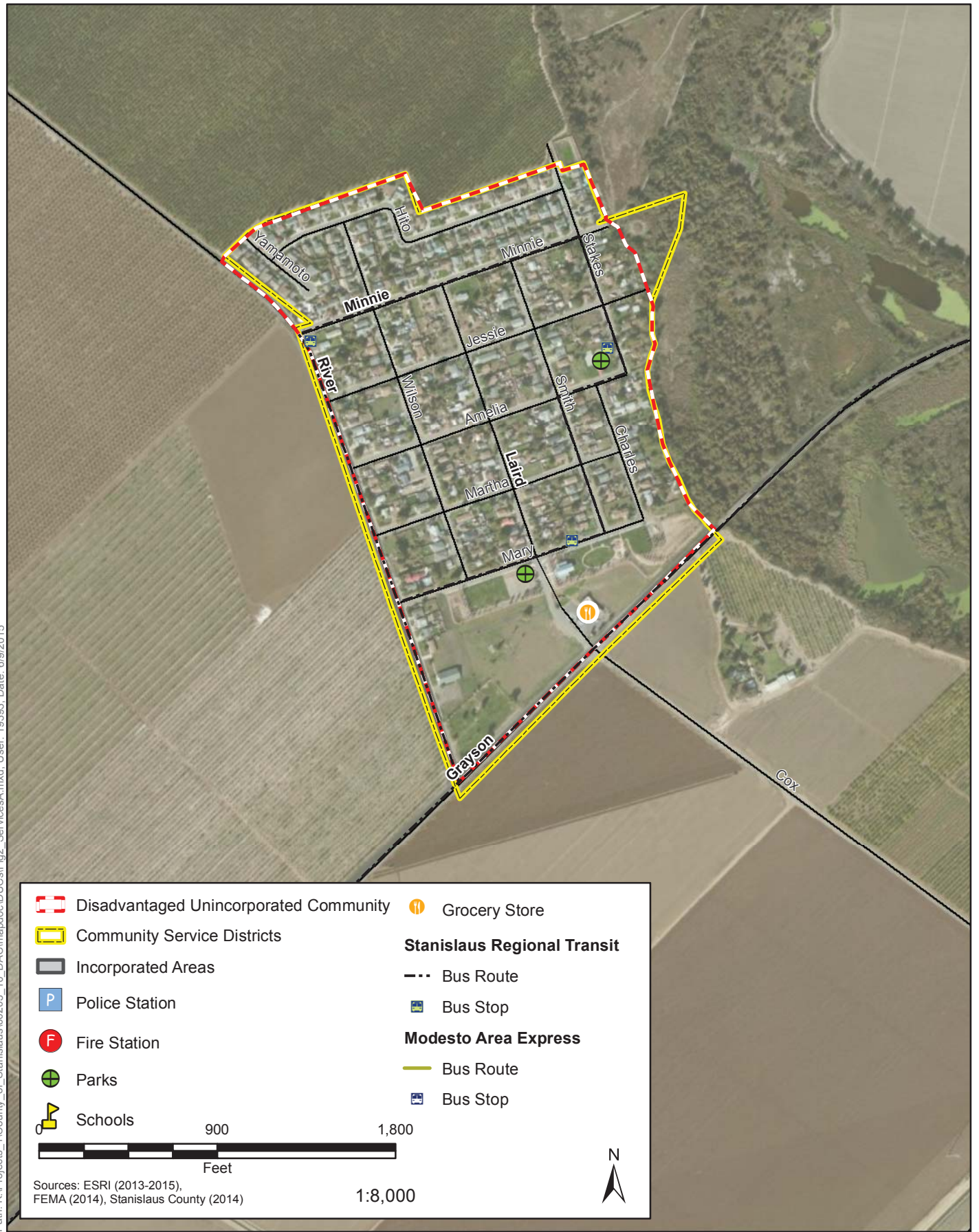

Figure 2-3  
Grayson Disadvantaged Unincorporated Community



***THIS PAGE INTENTIONALLY LEFT BLANK***



Gutters that run along the streets in Grayson drain into storm drain pipes and a detention basin that pumps to the San Joaquin River bottom, where the water flows overland to the river (Stanislaus County 2004). Grayson's storm drainage facilities are in good condition (Stanislaus County 2004).

### 2.3.5 Solid Waste Disposal

Stanislaus County contracts with four franchised solid waste collection companies, Bertolotti Disposal, Gilton Solid Waste, Modesto Disposal/Waste Management, and Turlock Scavenger, for residential and commercial garbage collection service in the unincorporated area (Stanislaus County 2014a). Grayson falls within County-designated Franchise Area 1, served by Bertolotti Disposal (Stanislaus County 2014b). Besides providing solid waste and recyclables collection services to Franchise Area 1, Bertolotti Disposal operates a transfer station, open to the public Mondays through Saturdays, on Flamingo Road in Ceres. Additionally, Stanislaus County's Fink Road Sanitary Landfill, a Class III landfill for nonhazardous municipal solid waste, is operated by the County's Department of Environmental Resources and is open Monday-Saturday to private citizens, school districts, businesses, and local agencies for individual disposal of solid waste (Stanislaus County 2014c).

### 2.3.6 Law Enforcement and Fire Protection

Law enforcement services for Grayson, as for the rest of unincorporated Stanislaus County and four contract cities, are provided by the Stanislaus County Sheriff's Department. The operations division of the Sheriff's Department provides law enforcement services to over 200,000 people in a 1,521-square-mile area (Stanislaus County Sheriff's Department 2014). Two units—patrol and investigations—comprise the Sheriff's Department operations division. The patrol unit responds to calls for assistance, investigates crime, makes arrests, and performs preventive patrol services (Stanislaus County Sheriff's Department 2014). The investigations unit follows up reports of major crimes, collects and prepares evidence for trials, apprehends offenders, and recovers stolen property (Stanislaus County Sheriff's Department 2014).

The nearest sheriff's station to Grayson is the main station, approximately 10.5 miles east at 250 East Hackett Road in Ceres. In addition, the Patterson police station, located approximately 8 miles southeast of Grayson in the city of Patterson, is staffed by the Stanislaus County Sheriff's Department, which provides contract police services to Patterson under the title of Patterson Police Services (Stanislaus Local Agency Formation Commission 2013).

The crime rates presented below were compiled by AGS using the primary reporting categories from the FBI 2005 - 2010 Uniform Crime Report databases along with preliminary 2011 release data and census data related to socioeconomic characteristics. The crimes are divided into two main categories, personal crimes (murder, rape, robbery, and assault) and property crimes (burglary, larceny, and motor vehicle theft). These crime rates are based on a comparison of the average local crime rate to the national average for the same crime, with a crime index of 100 considered average; scores above 100 are therefore considered greater, or worse, than average. For example, a score of 130 would represent a crime rate 30% greater than the national average for that type of crime. These crime rates are unweighted (i.e., a murder and a theft carry the same weight for calculation purposes), and are tracked at the census block group level and above, which may not correspond precisely to the DUC boundaries. Census blocks are the smallest geographic area for which the United States Census Bureau collects and tabulates data; a set of these constitutes a census block

group. Census blocks vary widely in geographic size, and are generally smaller in urban areas and progressively larger in suburban, rural, or remote areas; a given block group is larger in area and population than the individual census blocks of which it is made, and generally contains between 600 and 3,000 people (United States Census Bureau 1994). Grayson falls within census block group 060990033.001.

The overall personal crime and property crime indices for Grayson are 181 and 190, respectively, which means that personal crimes in Grayson occur at a rate 81% greater than the average nationwide, and property crimes occur at a rate 90% greater than the national average. The general and individual crime indices for these categories are shown in Table 2-9 below.

**Table 2-9. Grayson Crime Indices**

Personal Crime		Property Crime	
Personal Crime Index	181	Property Crime Index	190
Murder	88	Burglary	383
Rape	114	Larceny	201
Robbery	21	Motor Vehicle Theft	31
Assault	429		

Source: Applied Geographic Solutions and Atlas Publishing 2012.

The West Stanislaus FPD provides fire protection, emergency, and rescue services to Grayson, as well as to Crows Landing, Diablo Grande, and Westley (Emergency Services Consulting 2007). District-wide, 5 full-time firefighters per shift and 100 volunteers staff the West Stanislaus County Fire Protection District (Stanislaus Local Agency Formation Commission 2007). The West Stanislaus FPD's Fire Station No. 3 is located approximately 1 mile away from Grayson at 8598 Kern Street in Westley and houses WSF-Engine 3, WSF-Water Tender 3, and WSF-Rescue 3 (West Stanislaus Fire Protection District 2014). Volunteer firefighters staff the Westley Station (West Stanislaus Fire Protection District 2014).

A fire department's ability to meet the fire protection needs of its service area is typically evaluated by the Insurance Services Office (ISO), a private organization that assesses risks, including fire protection, for insurance purposes. The ISO considers a variety of factors, including a district's fire-fighting apparatus, staffing, training, location, and water supply, to rate fire departments on a scale from 1 (best fire protection possible) to 10 (no fire protection). The ISO rating therefore reflects a fire department's ability to protect the residents and businesses within its service area from fire. The West Stanislaus County FPD carries an ISO rating of 4 (West Stanislaus Fire Protection District 2015).

### 2.3.7 Schools and Community Amenities

Grayson lies within the boundaries of the Patterson Unified School District, which includes a total of 8 schools serving 6,023 students in grades K–12 (Stanislaus County Office of Education 2009; California Department of Education 2014e). The nearest elementary school to the community is Grayson Charter, approximately 2 miles southwest in Westley. Grayson Charter provides a dual-language immersion program in English and Spanish to 262 children in grades K–5 (California Department of Education 2014b). The nearest non-charter elementary school is Northmead

Elementary, located approximately 7 miles southwest in Patterson. Northmead Elementary serves 572 students in grades K–5 (California Department of Education 2014c). The nearest middle school to Grayson is Creekside Middle School in Patterson, serving 1,201 students in grades 6–8 (California Department of Education 2014a). The nearest high school to Grayson is Patterson High School, located approximately 8 miles southwest in Patterson and serving 1,690 students in grades 9–12 (California Department of Education 2014d).

Three public park facilities operated and maintained by the Stanislaus County Department of Parks and Recreation are present in the community of Grayson: Leroy F. Fitzsimmons Memorial Park, United Community Center and Park, and Laird Regional Park. Leroy F. Fitzsimmons Memorial Park is located on the eastern edge of Grayson at the corner of Amelia and Stakes Streets. The 0.5-acre park has a basketball court, picnic shelter, tables, and playground equipment (Stanislaus County n.d.). The 5-acre United Community Center and Park is at the intersection of Laird and Mary Streets, and includes a 3,165 square-foot community center building that serves as a meeting space for local events, recreational programs, after-school activities, and community programs (Stanislaus County n.d.). The park features play equipment, an amphitheater lawn area, barbecues, picnic tables, basketball courts, and informal play areas (Stanislaus County n.d.). Laird Park is a 97-acre regional park approximately 2 miles east of the community on the San Joaquin River. Laird Park features a baseball/softball field, a soccer field, informal play areas, picnic shelters with picnic tables and barbecues, river access, and an unpaved parking area (Stanislaus County n.d.). No restrooms are available at either Leroy F. Fitzsimmons Memorial Park or Laird Park (Stanislaus County n.d.).

One small convenience market with gas pumps and a laundromat, the One-Stop Market, is located in Grayson. The nearest full-service grocery stores are El Mercadito and the Westley Market/El Paisano Supermarket, both on Highway 33 in Westley, about 2 miles southwest of Grayson.

### 2.3.8 Air Quality and Chronic Health Conditions

Stanislaus County is within the northern part of the eight-county SJVAPCD, the regional public health agency responsible for air quality management in those eight counties. SJVAPCD cites several factors that contribute to the valley's air quality challenges, including high rates of chronic poverty and unemployment coupled with a high population growth rate, the presence of major transportation corridors, and topographic features such as the surrounding mountains combined with the area's meteorological conditions (San Joaquin Valley Air Pollution Control District 2014a). SJVAPCD notes that ozone, PM10, and PM2.5 are of special concern, causing or exacerbating a variety of health conditions (San Joaquin Valley Air Pollution Control District 2014a). The presence of PM2.5, primarily a winter condition, triggers heart attacks, asthma, bronchitis, and respiratory infections, and has a strong correlation with hospital admissions and deaths (San Joaquin Valley Air Pollution Control District 2014a).

GHGs are not a criteria air pollutant and do not directly affect human health. GHG emissions are largely the result of combustion, decay and digestive processes, and emissions of industrial gases with high climate change potential. Unlike criteria pollutants such as carbon monoxide, PM10, PM2.5, and ozone, GHGs do not collect within a specific area or air basin. Their harm is done at a global level through the effect of increased concentrations of GHGs in Earth's atmosphere.

Worldwide concern over GHG emissions is based on the climate change that they are causing by altering the way in which Earth's atmosphere traps solar radiation as heat. The adverse effects of global climate change include rising sea levels, changes in habitat conditions for plants and animals,

increased potential for wildfires, more severe weather extremes, and a reduction in California's winter snow pack, among others. Through the impetus of AB 32 (California Global Warming Solutions Act of 2006) and other legislation, California has undertaken a statewide program of reducing GHG emissions to 1990 levels by 2020 in order to slow the rate of global climate change.

Climate change can have an indirect effect on human health in Stanislaus County to the extent that it results in warmer summer temperatures that facilitate ozone formation and exacerbate heat-related stress among outdoor workers, the elderly, small children, and the infirm. The amount of GHGs emitted within the Grayson DUC is not atypical for a small, rural community.

SJVAPCD operates 36 air monitoring sites within its eight-county air basin. Of these, two air quality stations, one in Modesto and another in Turlock, monitor air quality within Stanislaus County. The Modesto monitoring site is the closest to Grayson, approximately 11 miles northeast of the community. Table 2-10 shows the SJVAB's current air quality attainment status for state and federal criteria pollutants (San Joaquin Valley Air Pollution Control District 2012).

**Table 2.10. San Joaquin Valley Air Basin Air Quality Attainment Status**

Pollutant	Designation/Classification	
	Federal Standards	State Standards
Ozone—1-hour	No Federal Standard <sup>a</sup>	Nonattainment/Severe
Ozone—8-hour	Nonattainment/Extreme <sup>b</sup>	Nonattainment
PM 10	Attainment <sup>c</sup>	Nonattainment
PM 2.5	Nonattainment <sup>d</sup>	Nonattainment
Carbon monoxide	Attainment/Unclassified	Attainment/Unclassified
Nitrogen dioxide	Attainment/Unclassified	Attainment
Sulfur dioxide	Attainment/Unclassified	Attainment
Lead (particulate)	No Designation/Classification	Attainment
Hydrogen sulfide	No Federal Standard	Unclassified
Sulfates	No Federal Standard	Attainment
Visibility reducing particles	No Federal Standard	Unclassified
Vinyl chloride	No Federal Standard	Attainment

Source: San Joaquin Valley Air Pollution Control District 2012.

<sup>a</sup> Effective June 15, 2005, the U.S. Environmental Protection Agency (EPA) revoked the federal 1-hour ozone standard, including associated designations and classifications. EPA had previously classified the San Joaquin Valley air basin (SJVAB) as extreme nonattainment for this standard. EPA approved the 2004 Extreme Ozone Attainment Demonstration Plan on March 8, 2010 (effective April 7, 2010). Many applicable requirements for extreme 1-hour ozone nonattainment areas continue to apply to the SJVAB.

<sup>b</sup> Though the SJVAB was initially classified as serious nonattainment for the 1997 8-hour ozone standard, EPA approved SJVAB reclassification to extreme nonattainment in the Federal Register on May 5, 2010 (effective June 4, 2010).

<sup>c</sup> On September 25, 2008, EPA redesignated the SJVAB to attainment for the PM10 National Ambient Air Quality Standard (NAAQS) and approved the PM10 Maintenance Plan.

<sup>d</sup> The SJVAB is designated nonattainment for the 1997 PM2.5 NAAQS. EPA designated the SJVAB as nonattainment for the 2006 PM2.5 NAAQS on November 13, 2009 (effective December 14, 2009).

Over the past decade, ozone levels have been trending downward within the SJVAB and, in 2013, for the first time on record, the air basin overall had zero violations of the federal hourly ozone standard, compared to 281 violations in 1996 (San Joaquin Valley Air Pollution Control District 2014b). At the same time, PM<sub>2.5</sub> and PM<sub>10</sub> levels have fluctuated with no clear upward or downward trend (California Air Resources Board 2015). Table 2-11 presents the number of days in which Stanislaus County ozone, PM<sub>2.5</sub>, and PM<sub>10</sub> levels exceeded state and federal air quality standards in 2013 (California Air Resources Board 2015).

**Table 2-11. Stanislaus County Days in Exceedance of State and Federal Air Quality Standards, 2013**

Monitoring Site	Ozone			PM 2.5	PM 10
	# Days > State 1-Hr Standard	# Days > National '08 8-Hr Standard	# Days > State 8-Hr Standard	Est Days > National 24-Hr Standard	Est Days > State 24-Hr Standard
Modesto 14th St.	0	2	13	37.6	57.7
Turlock S. Minaret St.	1	14	24	40.3	73.7

Source: California Air Resources Board 2015.

The 2013 CHA, prepared by the Stanislaus County Health Services Agency, presents data about the health and well-being of Stanislaus County residents, including information on the burden of five major chronic diseases—hypertension, heart disease, stroke, diabetes and asthma—and the environmental and behavioral factors that influence their prevalence. Primary environmental factors identified in the CHA as contributing to these chronic health conditions are air quality and retail food environment; behavioral factors include diet, fast food consumption, fruit and vegetable consumption, quality of clinical care, physical activity, obesity, and tobacco use (Stanislaus County Health Services Agency 2013). As measured in 2007, Stanislaus County has the second worst retail food environment in California, with 5.48 fast-food purveyors and convenience stores for every grocery store or produce vendor near residences, compared to 4.48 statewide, and a high rate of fast food consumption in the low income population (Stanislaus County Health Services Agency 2013). The county also has the highest prevalence of obesity in the state (31.5% compared to 21.2% statewide), particularly among males, and a higher percentage of smokers than the California average (Stanislaus County Health Services Agency 2013).

The CHA presents countywide data and also divides Stanislaus County into nine geographic regions, shown in Table 2-12 below. Grayson falls within the west side region identified in Table 2-12.

**Table 2-12. Community Health Assessment of Stanislaus County Geographic Regions**

Region	Communities
Central	Modesto (parts) and outlying areas with ZIP codes 95350, 95355, 95357, and 95358
East Central	Airport Neighborhood and East Modesto (parts) with ZIP code 95354
Southeast Side	Denair, Empire, Hughson, Hickman, La Grange, Waterford with ZIP codes 95316, 95319, 95326, 95323, 95329, and 95386
Northeast Side	Knights Ferry, Valley Home, Oakdale, Riverbank with ZIP codes 95230, 95361, and 95367
North Side	Del Rio, Salida and Modesto (parts) with ZIP codes 95356 and 95368
Southwest Central	West Modesto and South Modesto with ZIP code 95351
West Side	Crows Landing, Grayson, Newman, Patterson with ZIP codes 95313, 95360, 95363, 95385, and 95387
South Central	Ceres, Keyes with ZIP codes 95307 and 95328
South Side	Turlock with ZIP codes 95380 and 95382

Source: Stanislaus County Health Services Agency 2013:Table 1.

Chronic health conditions of concern within Stanislaus County include hypertension, heart disease, stroke, diabetes and asthma. According to the CHA, the percentage of Stanislaus adults diagnosed with high blood pressure increased 31.2% between 2001 and 2009, and surpassed the percentage of California adults diagnosed with high blood pressure use. As of 2009, approximately 30.7% of Stanislaus County adults were diagnosed with hypertension, compared to 26.2% statewide. Among Stanislaus County's nine regions, the west side, including Grayson, has the lowest rate of hypertension-related emergency room visits, ranks fifth for hypertension-related hospitalizations, and has the second-lowest hypertension-related mortality rate (Stanislaus County Health Services Agency 2013).

The CHA notes that in 2009, 5% of Stanislaus County adults had been diagnosed with heart disease, compared to 5.9% statewide and 12% of adults nationwide. Stanislaus County's west side has the second-lowest rate among the county's nine regions for heart disease-related emergency room visits, the lowest rate of heart disease-related hospitalizations, and the fourth-highest mortality rate (Stanislaus County Health Services Agency 2013).

The CHA indicates that the California Health Interview Survey, on which it relies for some data, has not consistently tracked either the overall prevalence of cancer or the rates of individual types of cancer; data for cancer rates is therefore less current than for other, more closely tracked, conditions. Although the percentage of Stanislaus County adults diagnosed with cancer has increased from 7.4% in 2001 to 8.5% in 2005, it remains lower than the statewide rate. However, at a rate of approximately 21.4% of all deaths annually, cancer is the second most common cause of death in Stanislaus County. The west side of Stanislaus County ranks seventh (third-fewest) among the nine regions for cancer-related emergency room visits, has the lowest rate of cancer-related hospitalizations, and has the highest rate of cancer-related mortality (Stanislaus County Health Services Agency 2013).

Diabetes, according to the CHA, affects 8.3% of the United States population and is the seventh leading cause of death nationwide. Within California, from 2001 to 2007, the percentage of people diagnosed with diabetes increased from 6.2% to 8.5%, a 37% increase. Trends in Stanislaus County

are consistent with the statewide increase; in 2009, 7.6% of adults in Stanislaus County had been diagnosed with diabetes. While the prevalence of diabetes was lower in Stanislaus County than California, in 2011, Stanislaus County had higher hospitalization rates than California for four primary indicators of diabetes management, including hospitalization for short-term complications, long-term complications, lower-extremity amputation, and uncontrolled diabetes (Stanislaus County Health Services Agency 2013). Among Stanislaus County's nine regions, the west side has the lowest rate of diabetes-related emergency room visits, the third-lowest rate of hospitalizations, and the highest rate of diabetes-related mortality (Stanislaus County Health Services Agency 2013).

According to the CHA, in 2009 the percentage of Stanislaus County adults diagnosed with asthma was 21.8%, compared to 13.5% of the adult population statewide. The west side region has the second-lowest rate of asthma-related emergency room visits and hospitalizations among the county's nine regions (Stanislaus County Health Services Agency 2013). Due to the low asthma-related death rate, the CHA does not track or rank asthma-related mortality.

The CHA also uses LEB as a measure of quality of life within Stanislaus County and each of its nine regions. LEB is defined as the number of years a newborn infant is projected to live if mortality patterns at the time of its birth were to remain the same throughout its life. The LEB for Stanislaus County is calculated to be 77.2 years, 1.7 years less than the nationwide LEB of 78.9. The LEBs within the nine Stanislaus County regions range from a high of 80.27 years to a low of 75.01 years; the west side region ranks third-highest, with a LEB of 79.58 years (Stanislaus County Health Services Agency 2013).

## 2.3.9 References

Applied Geographic Solutions and Atlas Publisher. 2012. Crime Index for the U.S. Retrieved through ArcGIS. Available: [http://megacity.esri.com/ArcGIS/rest/services/Demographics/USA\\_CrimeIndex/MapServer](http://megacity.esri.com/ArcGIS/rest/services/Demographics/USA_CrimeIndex/MapServer). Accessed: 2012.

California Air Resources Board. 2015. *Select 8 Summary*. Available: <http://www.arb.ca.gov/adam/select8/sc8start.php>. Accessed: January 22, 2015.

California Department of Conservation. 2012. Division of Land Resource Protection. *Stanislaus County Williamson Act FY 2010/2011, Sheet 1 of 2*. Available: [ftp://ftp.consrv.ca.gov/pub/dlrp/wa/stanislaus\\_north\\_10\\_11\\_WA.pdf](ftp://ftp.consrv.ca.gov/pub/dlrp/wa/stanislaus_north_10_11_WA.pdf). Accessed: January 16, 2015.

California Department of Conservation. 2014. Division of Land Resource Protection. *Rural Land Mapping Edition, Stanislaus County Important Farmland 2012, Sheet 1 of 2*. Available: [ftp://ftp.consrv.ca.gov/pub/dlrp/FMMP/pdf/2012/sta12\\_no.pdf](ftp://ftp.consrv.ca.gov/pub/dlrp/FMMP/pdf/2012/sta12_no.pdf). Accessed: January 16, 2015.

California Department of Education. 2014a. *Creekside Middle School Profile: Fiscal Year 2013-14*. Available: [http://www.ed-data.k12.ca.us/App\\_Resx/EdDataClassic/fsTwoPanel.aspx?#!bottom=/layouts/EdDataClassic/profile.asp?Tab=0&level=07&reportnumber=16&county=50&district=71217&school=6060297](http://www.ed-data.k12.ca.us/App_Resx/EdDataClassic/fsTwoPanel.aspx?#!bottom=/layouts/EdDataClassic/profile.asp?Tab=0&level=07&reportnumber=16&county=50&district=71217&school=6060297). Accessed: November 19, 2014.

- California Department of Education. 2014b. *Grayson Charter School Profile: Fiscal Year 2013–14*. Available: [http://www.ed-data.k12.ca.us/App\\_Resx/EdDataClassic/fsTwoPanel.aspx?#!bottom=/layouts/EdDataClassic/profile.asp?tab=1&level=07&ReportNumber=16&County=50&fyr=1314&District=71217&School=6052922](http://www.ed-data.k12.ca.us/App_Resx/EdDataClassic/fsTwoPanel.aspx?#!bottom=/layouts/EdDataClassic/profile.asp?tab=1&level=07&ReportNumber=16&County=50&fyr=1314&District=71217&School=6052922). Accessed: November 19, 2014.
- California Department of Education. 2014c. *Northmead Elementary School Profile: Fiscal Year 2013–14*. Available: [http://www.ed-data.k12.ca.us/App\\_Resx/EdDataClassic/fsTwoPanel.aspx?#!bottom=/layouts/EdDataClassic/profile.asp?tab=0&level=07&ReportNumber=16&County=50&fyr=1314&District=71217&School=6052955](http://www.ed-data.k12.ca.us/App_Resx/EdDataClassic/fsTwoPanel.aspx?#!bottom=/layouts/EdDataClassic/profile.asp?tab=0&level=07&ReportNumber=16&County=50&fyr=1314&District=71217&School=6052955). Accessed: November 19, 2014.
- California Department of Education. 2014d. *Patterson High School Profile: Fiscal Year 2013–14*. Available: [http://www.ed-data.k12.ca.us/App\\_Resx/EdDataClassic/fsTwoPanel.aspx?#!bottom=/layouts/EdDataClassic/profile.asp?tab=0&level=07&ReportNumber=16&County=50&fyr=1314&District=71217&School=5036256](http://www.ed-data.k12.ca.us/App_Resx/EdDataClassic/fsTwoPanel.aspx?#!bottom=/layouts/EdDataClassic/profile.asp?tab=0&level=07&ReportNumber=16&County=50&fyr=1314&District=71217&School=5036256). Accessed: November 19, 2014.
- California Department of Education. 2014e. *Patterson School District Profile: Fiscal Year 2013–14*. Available: [http://www.ed-data.k12.ca.us/App\\_Resx/EdDataClassic/fsTwoPanel.aspx?#!bottom=/layouts/EdDataClassic/profile.asp?tab=1&level=06&ReportNumber=16&County=50&fyr=1314&District=71217](http://www.ed-data.k12.ca.us/App_Resx/EdDataClassic/fsTwoPanel.aspx?#!bottom=/layouts/EdDataClassic/profile.asp?tab=1&level=06&ReportNumber=16&County=50&fyr=1314&District=71217). Accessed: November 19, 2014.
- California Department of Water Resources. 2014a. *2014 Drought Grant Solicitation Draft Funding Recommendations*. September 23, 2014. Available: [http://www.water.ca.gov/irwm/grants/docs/Archives/Prop84/Awards/P84Imp\\_Drought\\_2014\\_DraftFundingRecTable.pdf](http://www.water.ca.gov/irwm/grants/docs/Archives/Prop84/Awards/P84Imp_Drought_2014_DraftFundingRecTable.pdf). Accessed: November 2, 2015.
- California Department of Water Resources. 2014b. *List of Awarded Projects, 2014 IRWM Drought Grant Solicitation*. October 2014. Available: [http://www.water.ca.gov/irwm/grants/docs/Archives/Prop84/Awards/IRWM\\_84\\_IG\\_Drought\\_Round\\_IRWM\\_FinalAwards\\_ProjectList.pdf](http://www.water.ca.gov/irwm/grants/docs/Archives/Prop84/Awards/IRWM_84_IG_Drought_Round_IRWM_FinalAwards_ProjectList.pdf). Accessed: November 2, 2015.
- City of Modesto. 2009. *Modesto Area Express: ACE, Amtrak, BART*. Available: <http://www.modestoareaexpress.com/commuter/>. Accessed: July 10, 2014.
- City of Modesto. 2010. *2010 Water System Engineer's Report – Options A & B*. May 2010. Available: <https://www.modestogov.com/uppd/reports/>. Accessed: November 2, 2015.
- City of Modesto. 2014. *Grayson 2014 Annual Water Quality Report*. Available: <https://www.modestogov.com/uppd/reports/water/regs/ccr/grayson.pdf>. Accessed; October 30, 2015.
- Emergency Services Consulting. 2007. *Stanislaus LAFCO Countywide Fire Services Municipal Service Review*. Final Report. March 2007. Prepared for Stanislaus Local Agency Formation Commission. Available: <http://www.stanislauslafco.org/info/FireMSR.htm>. Accessed: August 26, 2014.
- San Joaquin Valley Air Pollution Control District. 2012. *Ambient Air Quality Standards & Valley Attainment Status*. Available: <http://www.valleyair.org/aqinfo/attainment.htm>. Accessed: January 22, 2015.



- San Joaquin Valley Air Pollution Control District. 2014a. *Air Quality in the San Joaquin Valley*. Available: <http://www.valleyair.org/kids/docs/Generalpptforwebsite-2014.pdf>. Accessed; January 22, 2015.
- San Joaquin Valley Air Pollution Control District. 2014b. *Report to the Community, 2013–14 Edition*. Available: <http://www.valleyair.org/2013-14-AnnualReport.pdf>. Accessed; January 22, 2015.
- Stanislaus Council of Governments. 2014. *2014 Regional Transportation Plan / Sustainable Communities Strategy, Stanislaus County*. June 2014. Available: <http://www.stancog.org/pdf/rtp/final-2014-rtpscs.pdf>. Accessed: December 3, 2014.
- Stanislaus County. 2004. *Storm Water Management Program for Stanislaus County*. Available: <http://www.stancounty.com/publicworks/storm/pdf/sw-management-plan.pdf>. Accessed: December 10, 2014.
- Stanislaus County. 2006. *Circulation Element of the Stanislaus County General Plan*. Updated April 18, 2006. Available: <http://www.stancounty.com/planning/pl/gp/gp-chapter2.pdf>. Accessed: December 12, 2014.
- Stanislaus County. 2012. *Stanislaus County General Plan Housing Element 2009-2014*. Adopted August 28, 2012.
- Stanislaus County. 2014a. *Solid Waste Management*. Available: <http://www.stancounty.com/ER/solid-waste-ordinance.shtm>. Accessed: November 18, 2014.
- Stanislaus County. 2014b. *Solid Waste Management Franchise Area Map*. Available: <http://www.stancounty.com/ER/pdf/rates/franchiseareamap.pdf>. Accessed: November 18, 2014.
- Stanislaus County. 2014c. *Landfill Division: Fink Road Sanitary Landfill*. Available: <http://www.stancounty.com/ER/landfill-division.shtm>. Accessed: November 18, 2014.
- Stanislaus County. 2014d. *Zoning Districts*. Available: <http://www.stancounty.com/Planning/pl/zoning-ordinance.shtm>. Accessed: November 20, 2014.
- Stanislaus County. No Date. *Community Parks, Facilities, and Fishing Accesses*. Available: <http://www.stancounty.com/er/parks/pdf/community-parks-brochure.pdf>. Accessed: December 10, 2014.
- Stanislaus County Health Services Agency. 2013. *2013 Stanislaus County Community Health Assessment*.
- Stanislaus County Office of Education. 2009. *Patterson Joint Unified School District Map*. Available: [http://www.stancoe.org/scoe/resources/district\\_maps/Patterson\\_JUSD.pdf](http://www.stancoe.org/scoe/resources/district_maps/Patterson_JUSD.pdf). Accessed: November 19, 2014.
- Stanislaus County Sheriff's Department. 2014. *Operations Division*. Available: <http://www.scsdonline.com/operations-division/>. Accessed: November 21, 2014.
- Stanislaus Local Agency Formation Commission. 2007. *Countywide Fire Services Municipal Service Review*. Available: <http://www.stanislauslafco.org/info/PDF/FireMSR/CoverContents.pdf>. Accessed: December 10, 2014.

- Stanislaus Local Agency Formation Commission. 2013. *Municipal Service Review/Sphere of Influence Plan, City of Patterson, Stanislaus County, California*. Available: <http://www.stanislauslafco.org/info/pdf/msr/patterson.pdf>. Accessed: December 2, 2014.
- Stanislaus Local Agency Formation Commission. 2014. *Municipal Service Review and Sphere Of Influence Update For: Crows Landing, Grayson, and Westley Community Services Districts*. Available: <http://www.stanislauslafco.org/info/PDF/MSR/Districts/CrowsLGraysonWestleyCSD.pdf>. Accessed: December 10, 2014.
- Stanislaus Regional Transit. 2014a. *System Maps and Quick Guide*. Available: [http://www.srt.org/start\\_system\\_maps2.html](http://www.srt.org/start_system_maps2.html). Accessed: December 23, 2014.
- Stanislaus Regional Transit. 2014b. *Stanislaus Regional Transit – Route 40*. Available: [http://www.srt.org/route\\_40.html](http://www.srt.org/route_40.html). Accessed: July 10, 2014.
- Stanislaus Regional Transit. 2014c. *Stanislaus Regional Transit System Map - Fixed Routes, Shuttles, Runabout & Dial-A-Rides*. Available: [http://www.srt.org/start\\_system\\_maps2.html](http://www.srt.org/start_system_maps2.html). Accessed: December 23, 2014.
- United States Census Bureau. 1994. *Geographic Areas Reference Manual*. Available: <https://www.census.gov/geo/reference/garm.html>. Accessed: December 8, 2014.
- United States Census Bureau. 2013a. *American Fact Finder DP-1, Profile of General Population and Housing Characteristics 2010, Grayson CDP, California*. Available: <http://factfinder.census.gov/faces/nav/jsf/pages/inex.xhtml>. Accessed: July 10, 2014.
- United States Census Bureau. 2013b. *American Fact Finder DP03, Selected Economic Characteristics, 2009-2013 American Community Survey 5-Year Estimates, Grayson CDP, California*. Available: <http://factfinder.census.gov/faces/nav/jsf/pages/inex.xhtml>. Accessed: July 10, 2014.
- West Stanislaus Fire Protection District. 2014. *Fire Station 3-Westley*. Available: <http://www.weststanfire.org/fire-station-3/>. Accessed: November 21, 2014.
- West Stanislaus Fire Protection District. 2015. *ISO Rating Update*. Available: <http://www.weststanfire.org/iso-rating-update/>. Accessed: June 1, 2015.

## 2.4 Keyes

### 2.4.1 General Characteristics and Demographics

Keyes is a 1,810-acre unincorporated community spanning SR 99 in central Stanislaus County, roughly halfway between the cities of Ceres and Turlock. The northern edge of Keyes is about 1 mile southeast of Ceres and the southern edge of Keyes is about 1 mile northwest of Turlock. Keyes is bordered by Redwood Road on the north, Washington Road on the east, Keyes Road on the south, Faith Home Road on the southwest and SR 99 on the northwest. Turlock Irrigation District's Laterals No. 2 ½ and No. 3 cross Keyes in an east-west direction, SR 99 bisects the southern part of the community from northwest to southeast, and the Union Pacific Railroad tracks parallel the western side of SR 99. Keyes is surrounded by agricultural land, including both field crops and orchards, as well as accompanying agriculture-related structures and residences.

Keyes is a predominantly residential community with some commercial and public uses. Residences in Keyes are primarily single-family dwelling units, with a small quantity of duplexes and multifamily units, and several mobile home parks (United States Census Bureau 2013a). In 2010, Keyes had 1,714 housing units, 1,588 of which were occupied (United States Census Bureau 2013a). Commercial uses in Keyes include large-scale agricultural-industrial facilities and agricultural packing and shipping operations, primarily located west of SR 99. Numerous smaller service and retail businesses, as well as an elementary school, a public library, a fire station, and a United States post office, lie immediately east of SR 99.

Keyes is a CDP with a 2010 census population of 5,601 people in 1,588 households and an average household size of 3.29 (United States Census Bureau 2013a, 2013b). In 2013, the median annual household income in California was \$60,190; in the Keyes CDP it was \$34,967 (United States Census Bureau 2013b).

At 1,810 acres, the Keyes CDP occupies a larger area than the 626-acre Keyes DUC and encompasses surrounding agricultural lands. The majority of these surrounding agricultural lands are identified by the California Department of Conservation's Important Farmlands Inventory as prime farmland (California Department of Conservation 2014). The agricultural lands outside the DUC do not support the requisite level of existing development for consideration under SB 244 and are unlikely to develop in the near future. Therefore, they are not included as part of the Keyes DUC studied for SB 244 purposes.

The General Plan's Housing Element identifies Keyes as a Residential Development Potential Study Area and indicates that available land, infrastructure, and services give Keyes the potential to accommodate 207 additional dwelling units (Stanislaus County 2012). The General Plan's Housing Element notes that a portion of Keyes falls within the Stanislaus County Redevelopment Project Area (Stanislaus County 2012). However, this is of little practical importance with the dissolution of the redevelopment agencies in California. Existing infrastructure and services for Keyes are described below.

### 2.4.2 Infrastructure, Utilities, and Services

Infrastructure, utilities, and services considered for the Keyes DUC are presented in Figure 2-4, *Keyes Disadvantaged Unincorporated Community*, and include transportation facilities and services

including roads, sidewalks, street lighting, and bus stops/service; water, wastewater, and storm drainage systems; solid waste disposal; public safety services such as law enforcement and fire protection; and access to community amenities and services such as schools, parks, and grocery stores. Data associated with chronic health conditions and air quality are described at a regional level because they are not available specifically for the Keyes DUC.

### 2.4.3 Transportation Facilities and Services

Transportation infrastructure in the Keyes area consists of public highways and roads, railroad tracks, and fixed-route and curb-to-curb bus service. SR 99, a major north-south route through California, passes through the community of Keyes; SR 99 consists of a six-lane divided freeway with limited access points; one on/off ramp, Keyes Road, provides access to and from SR 99 at the south end of Keyes. The nearest on/off ramp to the north of Keyes is Mitchell Road, approximately 0.7 mile north near Ceres. The Union Pacific railroad tracks bisect Keyes immediately west of and parallel to SR 99.

With the exception of SR 99, Faith Home Road, and Keyes Road, roadways within Keyes presently consist of two-lane local roads. Both Faith Home Road and Keyes Road two-lane major roads classified by the California Department of Transportation as major collectors (California Department of Transportation 2014; Stanislaus Council of Governments 2014). The County General Plan classifies Faith Home Road as a collector south of Keyes Road, and as a four-lane expressway north of Keyes Road; Keyes Road is classified as a major four-lane road west of Keyes Road, a six-lane expressway south of Keyes, and a four-lane expressway east of Washington Road (Stanislaus County 2006). Rohde Road/7<sup>th</sup> Street, paralleling the northeastern side of SR 99 through Keyes, is classified as a collector (Stanislaus County 2006). Collectors are intended to provide direct access to abutting property as well as movement of moderate volumes of people and goods for medium length trips, and serve as transition facilities, carrying traffic from lower to higher level roads, while expressways are intended to move high volumes of people and goods between urban areas within the county (Stanislaus County 2006).

Curbs, gutters, and street lights are present on the majority of roadways in and around Keyes, particularly in the central and outlying residential areas. One commercial area around Starlite Drive lies outside the boundaries of CSAs No. 5 and No. 26, but within the boundary of the Keyes CSD, and lacks curbs, gutters, and sidewalks. With the exception of one small segment of Jessup Road that has a curb and gutter, the area southwest of SR 99, comprised predominantly of agricultural-industrial and commercial uses with several single-family residences, lacks curbs, gutters, sidewalks, and street lights.

In 2009 Stanislaus County installed curbs, gutters, handicap curb returns, new street sections, and a storm drain collection system in an area generally bounded by SR 99 on the west, Anna Street on the north, the Bonita Ranch Subdivision on the east, and Nunes Road on the south (Stanislaus County 2009). When the County constructed curbs and gutters in 2009, individual property owners were given the opportunity to install sidewalks fronting their property at their own expense. Sidewalks are primarily limited to newer residential neighborhoods on the north, east, and south sides of town and, in the central area to those properties whose owners opted to install them during curb and gutter construction in 2009. The Keyes CSD provides street lighting service to areas within its approximately 444-acre boundary (Stanislaus Local Agency Formation Commission 2014).

Path: K:\Projects\_1\County\_of\_Stanslaus\00203\_10\_DAC\mapdoc\UCos\Fig2\_ServicesA.mxd; User: 19393; Date: 6/9/2015

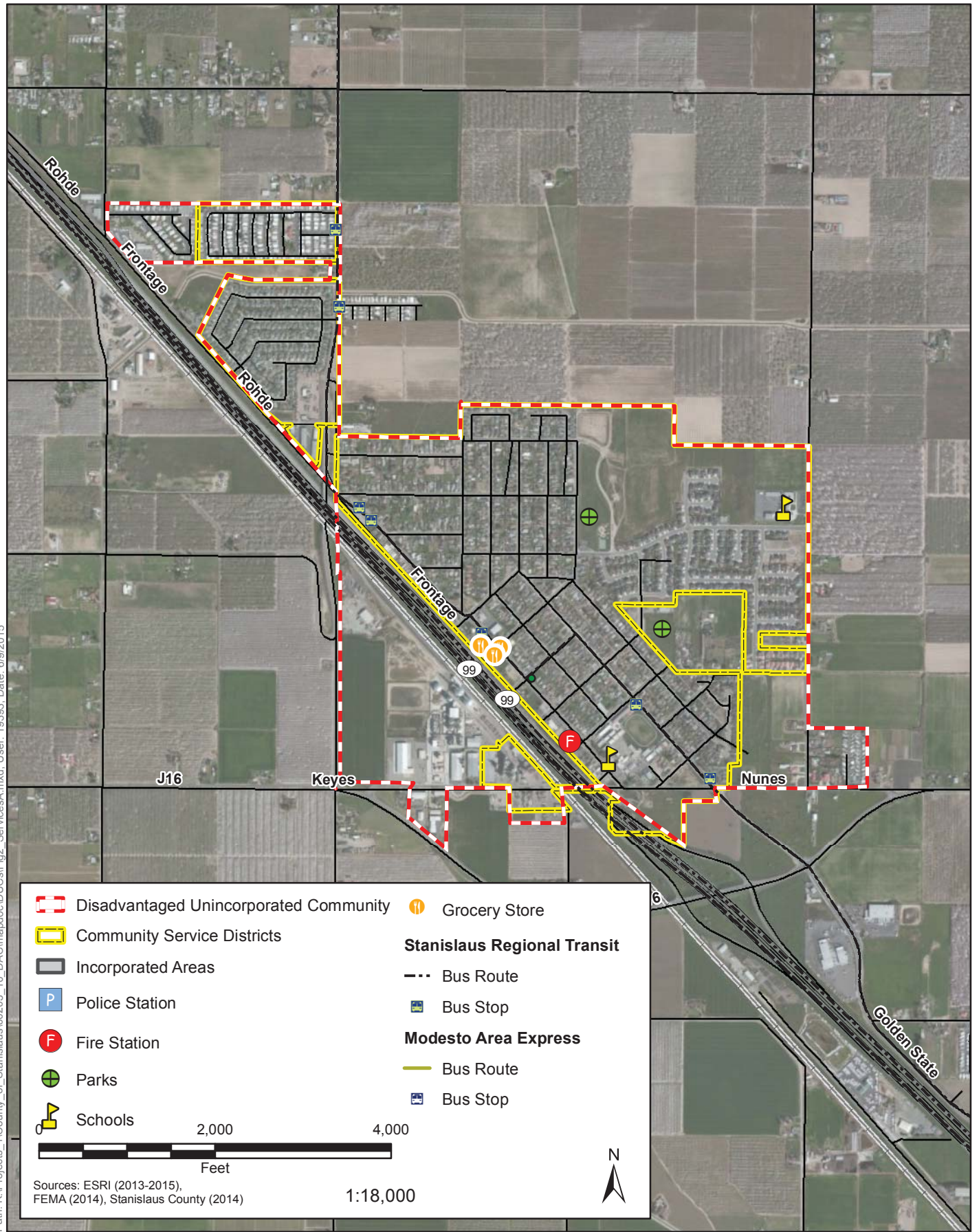

**Figure 2-4**  
**Keyes Disadvantaged Unincorporated Community**

***THIS PAGE INTENTIONALLY LEFT BLANK***

Fixed-route bus service on StaRT Route 15 connects Keyes to surrounding cities; Route 10 Express and Route 70 buses run through Keyes Monday–Friday without stopping on their trips between Modesto and Turlock (Stanislaus Regional Transit 2014a). Route 15 provides 12 round trips between Modesto and Turlock, with stops in Ceres and Keyes, Monday–Friday from 4:50 a.m. to 9:46 p.m., and 8 round trips on Saturdays between 6:30 a.m. and 8:32 p.m. (Stanislaus Regional Transit 2014a). From the Modesto Downtown Transit Center, passengers can transfer to buses traveling to other Stanislaus County communities, as well as to the Modesto Amtrak station, the ACE train station in Lathrop, and the Dublin BART station (City of Modesto 2009; Stanislaus Regional Transit 2014a). In addition, Keyes falls within the Turlock-Modesto Shuttle service area. The Turlock-Modesto Shuttle provides curb-to-curb service between the cities of Modesto, Ceres, and Turlock, the communities of Denair and Keyes, and surrounding rural areas (Stanislaus Regional Transit 2014a). Turlock-Modesto Shuttle runs Monday–Saturday, with four southbound trips between 7:00 a.m. and 4:00 p.m. and four northbound trips between 8:30 a.m. and 5:30 p.m. (Stanislaus Regional Transit 2014b).

#### **2.4.4 Water, Wastewater, and Stormwater Drainage Systems**

The Keyes CSD provides sewer and water services to the community of Keyes, and has a contractual agreement with the City of Turlock for sewer disposal services (Stanislaus Local Agency Formation Commission 2014). Together, CSA No. 5 and CSA No. 26 provide storm drainage service to approximately 372 acres of the community (Stanislaus Local Agency Formation Commission 2010). The boundaries of these CSAs roughly correspond to those of the Keyes CSD, which encompasses approximately 444 acres (Stanislaus Local Agency Formation Commission 2014).

The Keyes CSD provides its 444-acre district with domestic water from four groundwater wells (Stanislaus Local Agency Formation Commission 2014). Poor water quality is an issue in Keyes, as the level of arsenic in the groundwater exceeds the state’s maximum contaminant levels; the Keyes CSD is in the process of establishing treatment facilities to remediate this contaminant (Stanislaus Local Agency Formation Commission 2014). Most of the developed area of Keyes falls within the Keyes CSD boundaries. Some urban uses, including two mobile home parks, are outside the Keyes CSD’s boundaries but within its approximately 793-acre sphere of influence. Those uses are not presently served by the CSD. These areas currently rely on onsite wells for their water supply (Stanislaus Local Agency Formation Commission 2014). Once the water treatment facilities are completed, and pending Local Agency Formation Commission (LAFCO) approval of either an out-of-boundary service extension or annexation, the Keyes CSD plans to serve the mobile home parks outside its present boundaries with arsenic-free drinking water (Stanislaus Local Agency Formation Commission 2014).

Wastewater from the Keyes CSD is sent to the Turlock Regional Water Quality Control Facility for treatment (East Stanislaus Regional Water Management Partnership 2013). Scattered urban uses within the Keyes CSD sphere of influence, including the abovementioned mobile home parks, are presently served by onsite septic systems (Stanislaus Local Agency Formation Commission 2014). Although the Keyes CSD is meeting the needs of customers within its existing boundaries, the district recently purchased an additional 25,000 gallons per day of sewage treatment capacity from the City of Turlock, and developers have purchased capacity for future developments in Keyes (Stanislaus Local Agency Formation Commission 2014).

Stormwater drainage poses a challenge in Keyes due to the high water table, only 2.5 feet below the surface in some areas (Stanislaus County 2004). In 2009 Stanislaus County installed curbs, gutters, a

storm drain collection system, and related facilities in an area of Keyes generally bounded by SR 99 on the west, Anna Street on the north, the Bonita Ranch Subdivision on the east, and Nunes Road on the south (Stanislaus County 2009). The County also expanded Keyes' existing drainage basin and excavated an extension to the north of the basin (Stanislaus County 2009). Drainage in the remaining area of Keyes is provided by CSAs No. 5 and No. 26 via roadside ditches and detention basins (Stanislaus Local Agency Formation Commission 2010). Some of the basins allow only for percolation; the Starlite Place storm drain discharges to Turlock Irrigation District Lateral 2 ½ at Faith Home Road and CSA #26 discharges stormwater to Turlock Irrigation District Lateral 2 ½ just east of 10<sup>th</sup> Street (Stanislaus County 2004).

## 2.4.5 Solid Waste Disposal

Stanislaus County contracts with four franchised solid waste collection companies, Bertolotti Disposal, Gilton Solid Waste, Modesto Disposal/Waste Management, and Turlock Scavenger, for residential and commercial garbage collection service in unincorporated Stanislaus County (Stanislaus County 2014c). Keyes falls within County-designated Franchise Area 1, served by Bertolotti Disposal (Stanislaus County 2014b). Besides providing solid waste and recyclables collection services to Franchise Area 1, Bertolotti Disposal operates a transfer station, open to the public Mondays through Saturdays, on Flamingo Road in Ceres. Additionally, Stanislaus County's Fink Road Sanitary Landfill, a Class III landfill for nonhazardous municipal solid waste, is operated by the County's Department of Environmental Resources and is open Monday–Saturday to private citizens, school districts, businesses, and local agencies for individual disposal of solid waste (Stanislaus County 2014a).

## 2.4.6 Law Enforcement and Fire Protection

Law enforcement services for Keyes, as for the rest of unincorporated Stanislaus County and four contract cities, are provided by the Stanislaus County Sheriff's Department. The nearest sheriff's station to Keyes is the main station, about 4.5 miles northwest at 250 East Hackett Road in Ceres. The County Sheriff's Department also operates and staffs the Hughson police station, located approximately 3.5 miles northeast of Keyes in the city of Hughson (Stanislaus Local Agency Formation Commission 2005).

The Ceres police station is approximately 2.5 miles northwest of Keyes; however, the City of Ceres does not typically provide law enforcement services beyond its boundaries except under joint actions (Stanislaus Local Agency Formation Commission and City of Ceres 2012).

The operations division of the Sheriff's Department provides law enforcement services to over 200,000 people in a 1,521-square-mile area (Stanislaus County Sheriff's Department 2014). Two units—patrol and investigations—comprise the Sheriff's Department operations division. The patrol unit responds to calls for assistance, investigates crime, makes arrests, and performs preventive patrol services (Stanislaus County Sheriff's Department 2014). The investigations unit follows up reports of major crimes, collects and prepares evidence for trials, apprehends offenders, and recovers stolen property (Stanislaus County Sheriff's Department 2014).

The crime rates presented below were compiled by AGS using the primary reporting categories from the FBI 2005 – 2010 Uniform Crime Report databases along with preliminary 2011 release data and census data related to socioeconomic characteristics. The crimes are divided into two main categories, personal crimes (murder, rape, robbery, and assault) and property crimes (burglary,



larceny, and motor vehicle theft). These crime rates are based on a comparison of the average local crime rate to the national average for the same crime, with a crime index of 100 considered average; scores above 100 are therefore considered greater, or worse, than average. For example, a score of 130 would represent a crime rate 30% greater than the national average for that type of crime. These crime rates are unweighted (i.e., a murder and a theft carry the same weight for calculation purposes), and are tracked at the census block group level and above, which may not correspond precisely to the DUC boundaries. Census blocks are the smallest geographic area for which the United States Census Bureau collects and tabulates data; a set of these constitutes a census block group. Census blocks vary widely in geographic size, and are generally smaller in urban areas and progressively larger in suburban, rural, or remote areas; a given block group is larger in area and population than the individual census blocks of which it is made, and generally contains between 600 and 3,000 people (United States Census Bureau 1994). Keyes DUC falls within two census block groups. Most of Keyes east of SR 99 falls within census block group 060990030.023; the area west of SR 99, including the southwest portion of the DUC west of SR 99 and the northernmost portion of the DUC between SR 99 and Faith Home Road, falls within census block group 060990030.022.

The overall personal crime and property crime indices for most of Keyes (census block group 060990030.023) are 121 and 34, respectively, which means that personal crimes in that area occur at a rate 21% higher than the nationwide average, and property crimes occur at a rate 34% of the national average. For the outlying areas, northern and western Keyes (census block group 060990030.022), the overall personal crime and property crime indices are both 148. The general and individual crime indices for these categories are shown in Table 2-13 below.

**Table 2-13. Keyes Crime Indices**

Block Group	Personal Crime		Block Group	Property Crime	
	060990030.022	060990030.023		060990030.022	060990030.023
Personal Crime Index	148	121	Property Crime Index	148	34
Murder	151	57	Burglary	181	66
Rape	119	205	Larceny	104	38
Robbery	76	136	Motor Vehicle Theft	12	5
Assault	209	75			

Source: Applied Geographic Solutions and Atlas Publishing 2012.

The Keyes FPD provides fire protection, emergency response, and rescue services to a 20-square-mile area encompassing the community of Keyes (Emergency Services Consulting 2007). The Keyes FPD boundary abuts those of the Ceres, Hughson, Denair, Turlock Rural, and Mountain View FPDs (Emergency Services Consulting 2007). Small parts of the district fall within the spheres of influence of the cities of Ceres and Turlock (Emergency Services Consulting 2007). The Keyes FPD staffs one fire station, located at 5625 7th Street in Keyes, with 28 volunteers (Emergency Services Consulting 2007). These volunteers operate the district's three engines, one water tender, and rescue vehicle (Emergency Services Consulting 2007).

A fire department's ability to meet the fire protection needs of its service area is typically evaluated by the Insurance Services Office (ISO), a private organization that assesses risks, including fire

protection, for insurance purposes. The ISO considers a variety of factors, including a district's fire-fighting apparatus, staffing, training, location, and water supply, to rate fire departments on a scale from 1 (best fire protection possible) to 10 (no fire protection). The ISO rating therefore reflects a fire department's ability to protect the residents and businesses within its service area from fire. The Keyes FPD carries an ISO rating of 5 within its urbanized area and 9 for rural portions of its service area (Emergency Services Consulting 2007).

## 2.4.7 Public Services and Community Amenities

Keyes is served by the Keyes Union School District, comprised of 3 schools with 1,071 students in grades K–12 plus two preschool programs, Keyes Head Start and Keyes Preschool (Keyes Union School District 2012; Stanislaus County Office of Education 2009). One elementary school, Keyes Elementary, is located in Keyes and serves 518 children in grades K–5 (California Department of Education 2014b). The district's middle school, Barbara Spratling Middle School, serves 202 students in grades 6–8 (California Department of Education 2014a). The district's third school, Keyes to Learning Charter School, provides both classroom-based and home-study educational programs for 351 students in grades K–12; of these, 91 children are in grades 9–12 (California Department of Education 2014c; Keyes to Learning Charter School 2013).

Two parks, Bonita Ranch Park and Hatch Park, are located within Keyes and maintained by CSA No. 26 (Stanislaus Local Agency Formation Commission 2010). Both the 7-acre Bonita Ranch Park and the 4-acre Hatch Park are on the eastern side of Keyes. Bonita Ranch Park features picnic tables, a basketball court, soccer field, play structures, drinking fountains, paved pathways, and lighting (Stanislaus County n.d.). There are no restrooms at this facility (Stanislaus County n.d.). Hatch Park includes a baseball/softball field, community center, parking area and informal play area.

Keyes has three grocery stores, Tower Super Market, Food Cost U Less, and Keyes Market; all three are located at the intersection of 7<sup>th</sup> Street and Christine Street in central Keyes. Tower Super Market is a small, full-service market; Food Cost U Less and Keyes Market are small convenience markets. An additional convenience store, Dollar General, is under construction at 5521 7<sup>th</sup> Street and scheduled to open in late 2015. The nearest large-scale, full-service supermarket is Safeway, approximately 3.25 miles south of Keyes in Turlock.

## 2.4.8 Air Quality and Chronic Health Conditions

Stanislaus County is within the northern part of the eight-county SJVAPCD, the regional public health agency responsible for air quality management in those eight counties. SJVAPCD cites several factors that contribute to the valley's air quality challenges, including high rates of chronic poverty and unemployment coupled with a high population growth rate, the presence of major transportation corridors, and topographic features such as the surrounding mountains combined with the area's meteorological conditions (San Joaquin Valley Air Pollution Control District 2014a). SJVAPCD notes that ozone, PM<sub>10</sub>, and PM<sub>2.5</sub> are of special concern, causing or exacerbating a variety of health conditions (San Joaquin Valley Air Pollution Control District 2014a). The presence of PM<sub>2.5</sub>, primarily a winter condition, triggers heart attacks, asthma, bronchitis, and respiratory infections, and has a strong correlation with hospital admissions and deaths (San Joaquin Valley Air Pollution Control District 2014a).

GHGs are not a criteria air pollutant and do not directly affect human health. GHG emissions are largely the result of combustion, decay and digestive processes, and emissions of industrial gases

with high climate change potential. Unlike criteria pollutants such as carbon monoxide, PM10, PM2.5, and ozone, GHGs do not collect within a specific area or air basin. Their harm is done at a global level through the effect of increased concentrations of GHGs in Earth's atmosphere.

Worldwide concern over GHG emissions is based on the climate change that they are causing by altering the way in which Earth's atmosphere traps solar radiation as heat. The adverse effects of global climate change include rising sea levels, changes in habitat conditions for plants and animals, increased potential for wildfires, more severe weather extremes, and a reduction in California's winter snow pack, among others. Through the impetus of AB 32 (California Global Warming Solutions Act of 2006) and other legislation, California has undertaken a statewide program of reducing GHG emissions to 1990 levels by 2020 in order to slow the rate of global climate change.

Climate change can have an indirect effect on human health in Stanislaus County to the extent that it results in warmer summer temperatures that facilitate ozone formation and exacerbate heat-related stress among outdoor workers, the elderly, small children, and the infirm. The amount of GHGs emitted within the Keyes DUC is not atypical for a small, mixed use community. Although industrial uses are larger emitters than residences and Keyes is larger than the other DUCs in Stanislaus County, the fact that GHGs are not localized pollutants means that its residents are not exposed to any greater effect than the rest of Stanislaus County.

SJVAPCD operates 36 air monitoring sites within its eight-county air basin. Of these, two air quality stations, one in Modesto and another in Turlock, monitor air quality within Stanislaus County. Keyes is almost equidistant from the Modesto and Turlock monitoring sites, approximately 7 miles southeast of the Modesto station and 6.5 miles northwest of the Turlock site. Table 2-14 shows the SJVAB's current air quality attainment status for state and federal criteria pollutants (San Joaquin Valley Air Pollution Control District 2012).

**Table 2-14. San Joaquin Valley Air Basin Air Quality Attainment Status**

Pollutant	Designation/Classification	
	Federal Standards	State Standards
Ozone—1-hour	No Federal Standard <sup>a</sup>	Nonattainment/Severe
Ozone—8-hour	Nonattainment/Extreme <sup>b</sup>	Nonattainment
PM 10	Attainment <sup>c</sup>	Nonattainment
PM 2.5	Nonattainment <sup>d</sup>	Nonattainment
Carbon monoxide	Attainment/Unclassified	Attainment/Unclassified
Nitrogen dioxide	Attainment/Unclassified	Attainment
Sulfur dioxide	Attainment/Unclassified	Attainment
Lead (particulate)	No Designation/Classification	Attainment
Hydrogen sulfide	No Federal Standard	Unclassified
Sulfates	No Federal Standard	Attainment
Visibility reducing particles	No Federal Standard	Unclassified
Vinyl chloride	No Federal Standard	Attainment

Source: San Joaquin Valley Air Pollution Control District 2012.

- <sup>a</sup> Effective June 15, 2005, the U.S. Environmental Protection Agency (EPA) revoked the federal 1-hour ozone standard, including associated designations and classifications. EPA had previously classified the San Joaquin Valley air basin (SJVAB) as extreme nonattainment for this standard. EPA approved the 2004 Extreme Ozone Attainment Demonstration Plan on March 8, 2010 (effective April 7, 2010). Many applicable requirements for extreme 1-hour ozone nonattainment areas continue to apply to the SJVAB.
- <sup>b</sup> Though the SJVAB was initially classified as serious nonattainment for the 1997 8-hour ozone standard, EPA approved Valley reclassification to extreme nonattainment in the Federal Register on May 5, 2010 (effective June 4, 2010).
- <sup>c</sup> On September 25, 2008, EPA redesignated the SJVAB to attainment for the PM10 National Ambient Air Quality Standard (NAAQS) and approved the PM10 Maintenance Plan.
- <sup>d</sup> The SJVAB is designated nonattainment for the 1997 PM2.5 NAAQS. EPA designated the SJVAB as nonattainment for the 2006 PM2.5 NAAQS on November 13, 2009 (effective December 14, 2009).

Over the past decade, ozone levels have been trending downward within the SJVAB and, in 2013, for the first time on record, the air basin overall had zero violations of the federal hourly ozone standard, compared to 281 violations in 1996 (San Joaquin Valley Air Pollution Control District 2014b). At the same time, PM2.5 and PM10 levels have fluctuated with no clear upward or downward trend (California Air Resources Board 2015). Table 2-15 presents the number of days in which Stanislaus County ozone, PM2.5, and PM10 levels exceeded state and federal air quality standards in 2013 (California Air Resources Board 2015).

**Table 2-15. Stanislaus County Days in Exceedance of State and Federal Air Quality Standards, 2013**

Monitoring Site	Ozone			PM 2.5	PM 10
	# Days > State 1-Hr Standard	# Days > National '08 8-Hr Standard	# Days > State 8-Hr Standard	Est Days > National 24-Hr Standard	Est Days > State 24-Hr Standard
Modesto 14th St.	0	2	13	37.6	57.7
Turlock S. Minaret St.	1	14	24	40.3	73.7

Source: California Air Resources Board 2015.

The 2013 CHA, prepared by the Stanislaus County Health Services Agency, presents data about the health and well-being of Stanislaus County residents, including information on the burden of five major chronic diseases—hypertension, heart disease, stroke, diabetes and asthma—and the environmental and behavioral factors that influence their prevalence. Primary environmental factors identified in the CHA as contributing to these chronic health conditions are air quality and retail food environment; behavioral factors include diet, fast food consumption, fruit and vegetable consumption, quality of clinical care, physical activity, obesity, and tobacco use (Stanislaus County Health Services Agency 2013). As measured in 2007, Stanislaus County has the second worst retail food environment in California, with 5.48 fast-food purveyors and convenience stores for every grocery store or produce vendor near residences, compared to 4.48 statewide, and a high rate of fast food consumption in the low income population (Stanislaus County Health Services Agency 2013). The county also has the highest prevalence of obesity in the state (31.5% compared to 21.2% statewide), particularly among males, and a higher percentage of smokers than the California average (Stanislaus County Health Services Agency 2013).

The CHA presents countywide data and also divides Stanislaus County into nine geographic regions, shown in Table 2-16 below. Keyes falls within the south central region identified in Table 2-16.

**Table 2-16. Community Health Assessment of Stanislaus County Geographic Regions**

Region	Communities
Central	Modesto (parts) and outlying areas with ZIP codes 95350, 95355, 95357, and 95358
East Central	Airport Neighborhood and East Modesto (parts) with ZIP code 95354
Southeast Side	Denair, Empire, Hughson, Hickman, La Grange, Waterford with ZIP codes 95316, 95319, 95326, 95323, 95329, and 95386
Northeast Side	Knights Ferry, Valley Home, Oakdale, Riverbank with ZIP codes 95230, 95361, and 95367
North Side	Del Rio, Salida and Modesto (parts) with ZIP codes 95356 and 95368
Southwest Central	West Modesto and South Modesto with ZIP code 95351
West Side	Crows Landing, Grayson, Newman, Patterson with ZIP codes 95313, 95360, 95363, 95385, and 95387
South Central	Ceres, Keyes with ZIP codes 95307 and 95328
South Side	Turlock with ZIP codes 95380 and 95382

Source: Stanislaus County Health Services Agency 2013:Table 1.

Chronic health conditions of concern within Stanislaus County include hypertension, heart disease, stroke, diabetes and asthma. According to the CHA, the percentage of Stanislaus adults diagnosed with high blood pressure increased 31.2% between 2001 and 2009, and surpassed the percentage of California adults diagnosed with high blood pressure use. As of 2009, approximately 30.7% of Stanislaus County adults were diagnosed with hypertension, compared to 26.2% statewide. Among Stanislaus County's nine regions, the south central region has the fourth-lowest rate of hypertension-related hospitalizations, the second-highest rate of hypertension-related emergency room visits, and the fourth-highest rate of hypertension-related mortality (Stanislaus County Health Services Agency 2013).

The CHA notes that in 2009, 5% of Stanislaus County adults had been diagnosed with heart disease, compared to 5.9% statewide and 12% of adults nationwide. Stanislaus County's south central region has the fourth-lowest rate among the nine regions for heart disease-related emergency room visits, fourth-highest rate of hospitalizations, and third-lowest rate of heart disease-related mortality (Stanislaus County Health Services Agency 2013).

The CHA indicates that the California Health Interview Survey, on which it relies for some data, has not consistently tracked either the overall prevalence of cancer or the rates of individual types of cancer; data for cancer rates is therefore less current than for other, more closely tracked, conditions. Although the percentage of Stanislaus County adults diagnosed with cancer has increased from 7.4% in 2001 to 8.5% in 2005, it remains lower than the statewide rate. However, at a rate of approximately 21.4% of all deaths annually, cancer is the second most common cause of death in Stanislaus County. Stanislaus County's south central region has the fourth-highest rate of cancer-related emergency room visits and hospitalizations among the nine regions, and third-highest rate of cancer-related mortality (Stanislaus County Health Services Agency 2013).

Diabetes, according to the CHA, affects 8.3% of the United States population and is the seventh leading cause of death nationwide. Within California, from 2001 to 2007, the percentage of people diagnosed with diabetes increased from 6.2% to 8.5%, a 37% increase. Trends in Stanislaus County are consistent with the statewide increase; in 2009, 7.6% of adults in Stanislaus County had been diagnosed with diabetes. While the prevalence of diabetes was lower in Stanislaus County than California, in 2011, Stanislaus County had higher hospitalization rates than California for four primary indicators of diabetes management, including hospitalization for short-term complications, long-term complications, lower-extremity amputation, and uncontrolled diabetes (Stanislaus County Health Services Agency 2013). Among Stanislaus County's nine regions, the south central region has the fourth-highest rate of diabetes-related emergency room visits, the fourth-lowest rate of hospitalizations, and the third-lowest rate of diabetes-related mortality (Stanislaus County Health Services Agency 2013).

According to the CHA, in 2009 the percentage of Stanislaus County adults diagnosed with asthma was 21.8%, compared to 13.5% of the adult population statewide. Among Stanislaus County's nine regions, the south central region ranks fifth for asthma-related emergency room visits and third highest for asthma-related hospitalizations (Stanislaus County Health Services Agency 2013). Due to the low asthma-related death rate, the CHA does not track or rank asthma-related mortality.

The CHA also uses LEB as a measure of quality of life within Stanislaus County and each of its 9 regions. LEB is defined as the number of years a newborn infant is projected to live if mortality patterns at the time of its birth were to remain the same throughout its life. The LEB for Stanislaus County is calculated to be 77.2 years, 1.7 years less than the nationwide LEB of 78.9. The LEBs

within the nine Stanislaus County regions range from a high of 80.27 years to a low of 75.01 years; the south central region has the fourth-shortest life expectancy, with a LEB of 78.71 years (Stanislaus County Health Services Agency 2013).

## 2.4.9 References

- Applied Geographic Solutions and Atlas Publisher. 2012. Crime Index for the U.S. Retrieved through ArcGIS. Available: [http://megacity.esri.com/ArcGIS/rest/services/Demographics/USA\\_CrimeIndex/MapServer](http://megacity.esri.com/ArcGIS/rest/services/Demographics/USA_CrimeIndex/MapServer). Accessed: 2012.
- California Air Resources Board. 2015. *Select 8 Summary*. Available: <http://www.arb.ca.gov/adam/select8/sc8start.php>. Accessed: January 22, 2015.
- California Department of Conservation. 2014. Division of Land Resource Protection. *Rural Land Mapping Edition, Stanislaus County Important Farmland 2012, Sheet 1 of 2*. Available: [ftp://ftp.consrv.ca.gov/pub/dlrp/FMMP/pdf/2012/sta12\\_no.pdf](ftp://ftp.consrv.ca.gov/pub/dlrp/FMMP/pdf/2012/sta12_no.pdf). Accessed: January 16, 2015.
- California Department of Education. 2014a. *Barbara Spratling Middle School Profile: Fiscal Year 2013–14*. Available: [https://www.ed-data.k12.ca.us/App\\_Resx/EdDataClassic/fsTwoPanel.aspx?#!bottom=/layouts/EdDataClassic/profile.asp?tab=0&level=07&ReportNumber=16&County=50&fyr=1314&District=71134&School=6119002](https://www.ed-data.k12.ca.us/App_Resx/EdDataClassic/fsTwoPanel.aspx?#!bottom=/layouts/EdDataClassic/profile.asp?tab=0&level=07&ReportNumber=16&County=50&fyr=1314&District=71134&School=6119002). Accessed: November 19, 2014.
- California Department of Education. 2014b. *Keyes Elementary School Profile: Fiscal Year 2013–14*. Available: [https://www.ed-data.k12.ca.us/App\\_Resx/EdDataClassic/fsTwoPanel.aspx?#!bottom=/layouts/EdDataClassic/profile.asp?tab=0&level=07&ReportNumber=16&County=50&fyr=1314&District=71134&School=6052591](https://www.ed-data.k12.ca.us/App_Resx/EdDataClassic/fsTwoPanel.aspx?#!bottom=/layouts/EdDataClassic/profile.asp?tab=0&level=07&ReportNumber=16&County=50&fyr=1314&District=71134&School=6052591). Accessed: November 19, 2014.
- California Department of Education. 2014c. *Keyes to Learning Charter School Profile: Fiscal Year 2013–14*. Available: [https://www.ed-data.k12.ca.us/App\\_Resx/EdDataClassic/fsTwoPanel.aspx?#!bottom=/layouts/EdDataClassic/profile.asp?tab=0&level=07&ReportNumber=16&County=50&fyr=1314&District=71134&School=6113286](https://www.ed-data.k12.ca.us/App_Resx/EdDataClassic/fsTwoPanel.aspx?#!bottom=/layouts/EdDataClassic/profile.asp?tab=0&level=07&ReportNumber=16&County=50&fyr=1314&District=71134&School=6113286). Accessed: November 19, 2014.
- California Department of Transportation. 2014. *California Road System Map 0815*. May 19, 2014. Available: [http://www.dot.ca.gov/hq/tsip/hseb/crs\\_map/08151.pdf](http://www.dot.ca.gov/hq/tsip/hseb/crs_map/08151.pdf). Accessed: January 15, 2015.
- City of Modesto. 2009. *Modesto Area Express: ACE, Amtrak, BART*. Available: <http://www.modestoareaexpress.com/commuter/>. Accessed: July 10, 2014.
- East Stanislaus Regional Water Management Partnership. 2013. *Final East Stanislaus Integrated Water Management Plan*. December 2013. Available: <http://www.eaststanirwm.org/documents/esirwmp.pdf>. Accessed: December 10, 2014.
- Emergency Services Consulting. 2007. *Stanislaus LAFCO Countywide Fire Services Municipal Service Review*. Final Report. March 2007. Prepared for Stanislaus Local Agency Formation Commission. Available: <http://www.stanislauslafco.org/info/FireMSR.htm>. Accessed: August 26, 2014.

- Keyes to Learning Charter School. 2013. *Keyes to Learning Charter School Programs*. Available: <http://ktlcharterschool.com/ktl/programs/>. Accessed: November 19, 2014.
- Keyes Union School District. 2012. *Keyes Union School District Schools*. Available: <http://www.keyes.k12.ca.us/kusd-schools.html>. Accessed: November 19, 2014.
- San Joaquin Valley Air Pollution Control District. 2012. *Ambient Air Quality Standards & Valley Attainment Status*. Available: <http://www.valleyair.org/aqinfo/attainment.htm>. Accessed: January 22, 2015.
- San Joaquin Valley Air Pollution Control District. 2014a. *Air Quality in the San Joaquin Valley*. Available: <http://www.valleyair.org/kids/docs/Generalpptforwebsite-2014.pdf>. Accessed: January 22, 2015.
- San Joaquin Valley Air Pollution Control District. 2014b. *Report to the Community, 2013–14 Edition*. Available: <http://www.valleyair.org/2013-14-AnnualReport.pdf>. Accessed: January 22, 2015.
- Stanislaus Council of Governments. 2014. *2014 Regional Transportation Plan / Sustainable Communities Strategy, Stanislaus County*. June 2014. Available: <http://www.stancog.org/pdf/rtp/final-2014-rtpscs.pdf>. Accessed: December 3, 2014.
- Stanislaus County. 2004. *Storm Water Management Program for Stanislaus County*. Available: <http://www.stancounty.com/publicworks/storm/pdf/sw-management-plan.pdf>. Accessed: December 10, 2014.
- Stanislaus County. 2009. *District Two News*. Volume 1, Issue 1: Spring 2009. <http://www.stancounty.com/board/newsletter/district-two-newsletter-march-2009.pdf>. Accessed: January 15, 2015.
- Stanislaus County. 2012. *Stanislaus County General Plan Housing Element 2009-2014*. Adopted August 28, 2012.
- Stanislaus County. 2014a. *Landfill Division: Fink Road Sanitary Landfill*. Available: <http://www.stancounty.com/ER/landfill-division.shtm>. Accessed: November 18, 2014.
- Stanislaus County. 2014b. *Solid Waste Management Franchise Area Map*. Available: <http://www.stancounty.com/ER/pdf/rates/franchiseareamap.pdf>. Accessed: November 18, 2014.
- Stanislaus County. 2014c. *Solid Waste Management*. Available: <http://www.stancounty.com/ER/solid-waste-ordinance.shtm>. Accessed: November 18, 2014.
- Stanislaus County. No Date. *Community Parks, Facilities, and Fishing Accesses*. Available: <http://www.stancounty.com/er/parks/pdf/community-parks-brochure.pdf>. Accessed: December 10, 2014.
- Stanislaus County Health Services Agency. 2013. *2013 Stanislaus County Community Health Assessment*.
- Stanislaus County Office of Education. 2009. *Keyes Union School District Map*. Available: [http://www.stancoe.org/scoe/resources/district\\_maps/Keyes\\_USD.pdf](http://www.stancoe.org/scoe/resources/district_maps/Keyes_USD.pdf). Accessed: November 19, 2014.



- Stanislaus County Sheriff's Department. 2014. *Operations Division*. Available: <http://www.scsdonline.com/operations-division/>. Accessed: November 21, 2014.
- Stanislaus Local Agency Formation Commission and City of Ceres. 2012. *City of Ceres Municipal Service Review and Sphere of Influence Plan*. Available: <http://www.stanislauslafco.org/info/PDF/MSR/Ceres.pdf>. Accessed: August 26, 2014.
- Stanislaus Local Agency Formation Commission. 2005. *Hughson Municipal Service Review*. Available: <http://www.stanislauslafco.org/info/PDF/MSR/Hughson.pdf>. Accessed: August 26, 2014.
- Stanislaus Local Agency Formation Commission. 2010. *Municipal Service Review and Sphere of Influence Update for the County Service Areas within Stanislaus County*. Available: <http://www.stanislauslafco.org/info/PDF/MSR/Districts/CSAs.pdf>. Accessed: October 1, 2014.
- Stanislaus Local Agency Formation Commission. 2014. *Municipal Service Review and Sphere of Influence Update for Denair Community Services District and Keyes Community Services District*. Available: <http://www.stanislauslafco.org/info/PDF/MSR/Districts/Denair&KeyesCSD.pdf>. Accessed: October 1, 2014.
- Stanislaus Regional Transit. 2014a. *Stanislaus Regional Transit System Map - Fixed Routes, Shuttles, Runabout & Dial-A-Rides*. Available: [http://www.srt.org/start\\_system\\_maps2.html](http://www.srt.org/start_system_maps2.html). Accessed: July 10, 2014.
- United States Census Bureau. 1994. *Geographic Areas Reference Manual*. Available: <https://www.census.gov/geo/reference/garm.html>. Accessed: December 8, 2014.
- United States Census Bureau. 2013a. *American Fact Finder DP-1, Profile of General Population and Housing Characteristics 2010, Keyes CDP, California*. Available: <http://factfinder.census.gov/faces/nav/jsf/pages/index.xhtml>. Accessed: July 10, 2014.
- United States Census Bureau. 2013b. *American Fact Finder DP03, Selected Economic Characteristics, 2009-2013 American Community Survey 5-Year Estimates, Keyes CDP, California*. Available: <http://factfinder.census.gov/faces/nav/jsf/pages/index.xhtml>. Accessed: July 10, 2014.

***THIS PAGE INTENTIONALLY LEFT BLANK***

## 2.5 Monterey Park Tract

### 2.5.1 General Characteristics and Demographics

Monterey Park Tract is an approximately 30-acre rural neighborhood in central Stanislaus County consisting of single-family residential units approximately 4.5 miles southwest of the city of Ceres and 7 miles west of the city of Turlock. In 2010, Monterey Park Tract had 42 housing units, 35 of which were occupied (United States Census Bureau 2013a). Monterey Park Tract is roughly defined by Durango Avenue on the north, Foy Avenue on the east, La Siesta Avenue on the south, and Monterey Avenue on the west. Monterey Park Tract is surrounded by agricultural land and accompanying agriculture-related facilities and residences. The City of Modesto's Jennings Wastewater Treatment Plant and Modesto Compost Facility are located approximately 2.2 miles west of Monterey Park Tract. A variety of agricultural lands surround Monterey Park Tract; the majority of these lands are identified by the California Department of Conservation's Important Farmlands Inventory as prime farmland, with smaller areas of farmland of statewide importance, unique farmland and, immediately southwest and slightly southeast of Monterey Park Tract, confined animal facilities (California Department of Conservation 2014). Much of this area, particularly the adjacent land west, north, and east of the DUC, is also under Williamson Act contract (California Department of Conservation 2012).

Monterey Park Tract is a 30.2-acre CDP with a 2010 census population of approximately 133 people in 35 households (United States Census Bureau 2013a). In 2013, median annual household income in California was \$60,190; in Monterey Park Tract it was \$43,750 (United States Census Bureau 2013b). In addition to the residential uses, a church and a community center are present in Monterey Park Tract.

The General Plan's Housing Element identifies Monterey Park Tract as a Residential Development Potential Study Area that has the potential to accommodate 17 more dwelling units on existing vacant parcels (Stanislaus County 2012). Monterey Park Tract falls within the Stanislaus County Redevelopment Project Area (Stanislaus County 2012). However, this is of little practical importance with the dissolution of the redevelopment agencies in California. Existing infrastructure and services for Monterey Park Tract are described below.

### 2.5.2 Infrastructure, Utilities, and Services

Infrastructure, utilities, and services considered for the Monterey Park Tract DUC are presented in Figure 2-5, *Monterey Park Tract Disadvantaged Unincorporated Community*, and include transportation facilities and services including roads, sidewalks, street lighting, and bus stops/service; water, wastewater, and storm drainage systems; solid waste disposal; public safety services such as law enforcement and fire protection; and access to community amenities and services such as schools, parks, and grocery stores. Data associated with chronic health conditions and air quality are described at a regional level because they are not available specifically for the Monterey Park Tract DUC.

### 2.5.3 Transportation Facilities and Services

Monterey Park Tract lies approximately 6.7 miles west of SR 99, a major north-south travel corridor and a six-lane freeway in Stanislaus County. Transportation infrastructure in the immediate

***THIS PAGE INTENTIONALLY LEFT BLANK***

Path: K:\Projects\_1\County\_of\_Stanislaus\00203\_10\_DAC\mapdoc\UCos\Fig2\_ServicesA.mxd; User: 19393; Date: 6/9/2015



Figure 2-5  
Monterey Park Tract Disadvantaged Unincorporated Community

***THIS PAGE INTENTIONALLY LEFT BLANK***

Monterey Park Tract area consists of public two-lane roads. The Union Pacific Railroad tracks run northwest-southeast approximately 1.6 miles east of Monterey Park Tract.

The nearest roads outside the neighborhood are Crows Landing Road 0.9 mile to the east, Taylor Road 0.6 mile to the north, Carpenter Road 1 mile to the west, and Monte Vista Avenue 0.1 mile to the south. Crows Landing Road and Carpenter Road are currently two-lane major roads (Stanislaus Council of Governments 2014). Monte Vista Avenue is a two-lane rural collector, and Taylor Road is a two-lane local roadway (Stanislaus Council of Governments 2014). In the vicinity of the Monterey Park Tract DUC, the County General Plan classifies Crows Landing Road as a four-lane expressway, Carpenter Road as a major four-lane road, and both Monte Vista Avenue and Taylor Road as local roadways (Stanislaus County 2006). Expressways are intended to move high volumes of people and goods between urban areas within the county, while local roadways provide direct access to abutting property and movement of small volumes of people and goods for medium length trips in the agricultural areas of the County (Stanislaus County 2006).

Roads within Monterey Park Tract consist of two-lane local roadways and include Durango Avenue on the north, Foy Avenue on the east, La Siesta Avenue on the south, and Monterey Avenue on the west. A small number of street lights are present along each of these roadways. No sidewalks, curbs, or gutters exist within Monterey Park Tract (Stanislaus County 2012).

No bus service is available within Monterey Park Tract. The nearest bus routes are StaRT Routes 40 and 45 East. Route 40 travels east-west on Grayson Road, approximately 3 miles north of Monterey Park Tract; Route 45 East travels east-west on West Main Avenue, 2 miles south of the neighborhood (Stanislaus Regional Transit 2014). Monterey Park Tract lies approximately 2 miles outside the boundary of the Turlock-Modesto Shuttle service area (Stanislaus Regional Transit 2014).

## 2.5.4 Water, Wastewater, and Stormwater Drainage Systems

The Monterey Park Tract CSD provides the Monterey Park Tract community with domestic water from two groundwater wells (Stanislaus Local Agency Formation Commission 2010). Monterey Park Tract has a history of poor water quality, and its water supply has repeatedly exceeded California's Title 22 primary drinking water quality maximum contaminant level (MCL) for nitrate and the secondary MCL for manganese, and also recorded high levels of arsenic (Stanislaus County Board of Supervisors 2015). The Monterey Park Tract CSD commissioned a study, completed in September 2011, to evaluate these water quality problems, analyze water supply alternatives to resolve the problems, and identify the best solution (Fremming, Parson & Pecchenino 2011).

On January 26, 2015, a Water Service Agreement was executed among the Monterey Park Tract CSD, the City of Ceres, and Stanislaus County (Stanislaus County Board of Supervisors 2015). Under the Water Service Agreement, the City of Ceres will provide water to the Monterey Park Tract CSD, which will construct, own, and be responsible for the operation and maintenance of improvements necessary for the delivery of water from the City of Ceres water system. The planned water delivery system will connect to a City of Ceres water main on Crows Landing Road, approximately 0.5 mile south of Service Road, and extend roughly 4.5 miles to the Monterey Park Tract CSD delivery system (Stanislaus County Board of Supervisors 2015).

Wastewater is disposed through private septic systems (Fremming, Parson & Pecchenino 2011). No storm drainage system serves Monterey Park Tract.

## 2.5.5 Solid Waste Disposal

Stanislaus County contracts with four franchised solid waste collection companies, Bertolotti Disposal, Gilton Solid Waste, Modesto Disposal/Waste Management, and Turlock Scavenger, for residential and commercial garbage collection service in unincorporated Stanislaus County (Stanislaus County 2014a). Monterey Park Tract falls within County-designated Franchise Area 1, served by Bertolotti Disposal (Stanislaus County 2014b). Besides providing solid waste and recyclables collection services to Franchise Area 1, Bertolotti Disposal operates a transfer station, open to the public Mondays through Saturdays, on Flamingo Road in Ceres. Additionally, Stanislaus County's Fink Road Sanitary Landfill, a Class III landfill for nonhazardous municipal solid waste, is operated by the County's Department of Environmental Resources and is open Monday–Saturday to private citizens, school districts, businesses, and local agencies for individual disposal of solid waste (Stanislaus County 2014c).

## 2.5.6 Law Enforcement and Fire Protection

Law enforcement services for Monterey Park Tract, as for the rest of unincorporated Stanislaus County and four contract cities, are provided by the Stanislaus County Sheriff's Department. The nearest sheriff's station to Monterey Park Tract is the main station, approximately 5 miles northeast at 250 East Hackett Road in Ceres.

The operations division of the Sheriff's Department provides law enforcement services to over 200,000 people in a 1,521-square-mile area (Stanislaus County Sheriff's Department 2014). Two units—patrol and investigations—comprise the Sheriff's Department operations division. The patrol unit responds to calls for assistance, investigates crime, makes arrests, and performs preventive patrol services (Stanislaus County Sheriff's Department 2014). The investigations unit follows up reports of major crimes, collects and prepares evidence for trials, apprehends offenders, and recovers stolen property (Stanislaus County Sheriff's Department 2014).

The crime rates presented below were compiled by AGS using the primary reporting categories from the FBI 2005 – 2010 Uniform Crime Report databases along with preliminary 2011 release data and census data related to socioeconomic characteristics. The crimes are divided into two main categories, personal crimes (murder, rape, robbery, and assault) and property crimes (burglary, larceny, and motor vehicle theft). These crime rates are based on a comparison of the average local crime rate to the national average for the same crime, with a crime index of 100 considered average; scores above 100 are therefore considered greater, or worse, than average. For example, a score of 130 would represent a crime rate 30% greater than the national average for that type of crime. These crime rates are unweighted (i.e., a murder and a theft carry the same weight for calculation purposes), and are tracked at the census block group level and above, which may not correspond precisely to the DUC boundaries. Census blocks are the smallest geographic area for which the United States Census Bureau collects and tabulates data; a set of these constitutes a census block group. Census blocks vary widely in geographic size, and are generally smaller in urban areas and progressively larger in suburban, rural, or remote areas; a given block group is larger in area and population than the individual census blocks of which it is made, and generally contains between 600 and 3,000 people (United States Census Bureau 1994). The Monterey Park Tract DUC falls within census block group 060990031.001.

The overall personal crime and property crime indices for Monterey Park Tract are 173 and 121, respectively, which means that personal crimes in Monterey Park Tract occur at a rate 73% higher



than the nationwide average, and property crimes occur at a rate 21% higher than the national average. The general and individual crime indices for these categories are shown in Table 2-17 below.

**Table 2-17. Monterey Park Tract Crime Indices**

Personal Crime		Property Crime	
Personal Crime Index	173	Property Crime Index	121
Murder	235	Burglary	241
Rape	95	Larceny	134
Robbery	45	Motor Vehicle Theft	12
Assault	276		

Source: Applied Geographic Solutions and Atlas Publishing 2012.

The Westport FPD provides fire protection and emergency response services to the Monterey Park Tract and surrounding area from its one fire station, located approximately 3 miles northwest at 5160 South Carpenter Road. The Westport fire station serves a 45-square-mile area with a staff of 17 volunteer firefighters and houses two engines, one water tender, and one rescue vehicle (Emergency Services Consulting 2007). The station's workload, defined by the number of incidents per year, increased from just over 100 in 1987 to about 300 in 2005 (Emergency Services Consulting 2007).

A fire department's ability to meet the fire protection needs of its service area is typically evaluated by the Insurance Services Office (ISO), a private organization that assesses risks, including fire protection, for insurance purposes. The ISO considers a variety of factors, including a district's fire-fighting apparatus, staffing, training, location, and water supply, to rate fire departments on a scale from 1 (best fire protection possible) to 10 (no fire protection). The ISO rating therefore reflects a fire department's ability to protect the residents and businesses within its service area from fire. Westport FPD has an ISO rating of 8 within a 5-mile radius of the station (Emergency Services Consulting 2007).

## 2.5.7 Schools and Community Amenities

Monterey Park Tract lies within the boundaries of the Ceres Unified School District, which includes a total of 22 schools enrolling a total of 12,742 students in grades K–12 (Ceres Unified School District 2014a; Stanislaus County Office of Education 2009). The nearest elementary school to Monterey Park Tract is Westport Elementary, 2.8 miles north at 5218 South Carpenter Road; Westport Elementary serves 454 students in grades K–6 (California Department of Education 2014c; Ceres Unified School District 2013). The nearest junior high school is Blaker Kinser Junior High School, serving 612 students in grades 7 and 8, approximately 5.5 miles northeast of Monterey Park Tract at 1601 Kinser Road in Ceres. The nearest high school is Central Valley High School, approximately 4.8 miles northeast at 4033 South Central Avenue in Ceres (California Department of Education 2014a). Central Valley High School serves 1,686 students grades 9–12 (California Department of Education 2014b). The school district provides bus transportation to and from school for students living beyond walking distance to their schools (Ceres Unified School District 2014b).

No parks are present within the Monterey Park Tract. The nearest public park, Las Palmas boat launch facility, is approximately 4.5 miles southwest on the San Joaquin River at Las Palmas/West Main Street. The 3-acre Las Palmas facility occupies 1 mile of riverbank along the western bank of the river and features a concrete boat ramp, parking lot, day use area with picnic tables and barbecues, and restrooms (Stanislaus County n.d.[b]).

Several city parks lie approximately 4.5–4.7 miles northeast of Monterey Park Tract in southwest Ceres. Of these, Sam Ryno Neighborhood Park, at about 4.5 miles, is the closest but has no developed amenities; nearby developed park and recreational facilities include Strawberry Fields Park, Don Pedro Park, and Central Valley High School. Strawberry Fields Park is a neighborhood park featuring picnic facilities and play equipment, and Don Pedro Park features picnic facilities, play equipment, and an adult fitness area (City of Ceres 2010). The City of Ceres considers school facilities to be joint-use recreational facilities (City of Ceres 1997). Developed recreational amenities at Central Valley High School include baseball/softball fields, soccer fields, tennis courts, and a track.

There are no grocery stores in Monterey Park Tract. The nearest grocery store is Charlie's Market, a small convenience market, about 1.5 miles northeast at the corner of Crows Landing Road and Taylor Road. The nearest full-service supermarkets are Magic Market, approximately 4.5 miles northeast of Monterey Park Tract in Ceres, and La Perla Tapatia, about 5 miles north of Monterey Park Tract in Modesto.

## 2.5.8 Air Quality and Chronic Health Conditions

Stanislaus County is within the northern part of the eight-county SJVAPCD, the regional public health agency responsible for air quality management in those 8 counties. SJVAPCD cites several factors that contribute to the valley's air quality challenges, including high rates of chronic poverty and unemployment coupled with a high population growth rate, the presence of major transportation corridors, and topographic features such as the surrounding mountains combined with the area's meteorological conditions (San Joaquin Valley Air Pollution Control District 2014a). The SVAPCD notes that ozone, PM10, and PM2.5 are of special concern, causing or exacerbating a variety of health conditions (San Joaquin Valley Air Pollution Control District 2014a). The presence of PM2.5, primarily a winter condition, triggers heart attacks, asthma, bronchitis, and respiratory infections, and has a strong correlation with hospital admissions and deaths (San Joaquin Valley Air Pollution Control District 2014a).

GHGs are not a criteria air pollutant and do not directly affect human health. GHG emissions are largely the result of combustion, decay and digestive processes, and emissions of industrial gases with high climate change potential. Unlike criteria pollutants such as carbon monoxide, PM10, PM2.5, and ozone, GHGs do not collect within a specific area or air basin. Their harm is done at a global level through the effect of increased concentrations of GHGs in Earth's atmosphere.

Worldwide concern over GHG emissions is based on the climate change that they are causing by altering the way in which Earth's atmosphere traps solar radiation as heat. The adverse effects of global climate change include rising sea levels, changes in habitat conditions for plants and animals, increased potential for wildfires, more severe weather extremes, and a reduction in California's winter snow pack, among others. Through the impetus of AB 32 (California Global Warming Solutions Act of 2006) and other legislation, California has undertaken a statewide program of reducing GHG emissions to 1990 levels by 2020 in order to slow the rate of global climate change.

Climate change can have an indirect effect on human health in Stanislaus County to the extent that it results in warmer summer temperatures that facilitate ozone formation and exacerbate heat-related stress among outdoor workers, the elderly, small children, and the infirm. The amount of GHGs emitted within the Monterey Park Tract DUC is not atypical for a small, largely residential community.

SJVAPCD operates 36 air monitoring sites within its eight-county air basin. Of these, two air quality stations, one in Modesto and another in Turlock, monitor air quality within Stanislaus County. At approximately 8 miles to the northeast, the Modesto monitoring site is the closest to Monterey Park Tract. Table 2-18 shows the SJVAB's current air quality attainment status for state and federal criteria pollutants (San Joaquin Valley Air Pollution Control District 2012).

**Table 2-18. San Joaquin Valley Air Basin Air Quality Attainment Status**

Pollutant	Designation/Classification	
	Federal Standards	State Standards
Ozone—1-hour	No Federal Standard <sup>a</sup>	Nonattainment/Severe
Ozone—8-hour	Nonattainment/Extreme <sup>b</sup>	Nonattainment
PM 10	Attainment <sup>c</sup>	Nonattainment
PM 2.5	Nonattainment <sup>d</sup>	Nonattainment
Carbon monoxide	Attainment/Unclassified	Attainment/Unclassified
Nitrogen dioxide	Attainment/Unclassified	Attainment
Sulfur dioxide	Attainment/Unclassified	Attainment
Lead (particulate)	No Designation/Classification	Attainment
Hydrogen sulfide	No Federal Standard	Unclassified
Sulfates	No Federal Standard	Attainment
Visibility reducing particles	No Federal Standard	Unclassified
Vinyl chloride	No Federal Standard	Attainment

Source: San Joaquin Valley Air Pollution Control District 2012.

- <sup>a</sup> Effective June 15, 2005, the U.S. Environmental Protection Agency (EPA) revoked the federal 1-hour ozone standard, including associated designations and classifications. EPA had previously classified the San Joaquin Valley air basin (SJVAB) as extreme nonattainment for this standard. EPA approved the 2004 Extreme Ozone Attainment Demonstration Plan on March 8, 2010 (effective April 7, 2010). Many applicable requirements for extreme 1-hour ozone nonattainment areas continue to apply to the SJVAB.
- <sup>b</sup> Though the SJVAB was initially classified as serious nonattainment for the 1997 8-hour ozone standard, EPA approved Valley reclassification to extreme nonattainment in the Federal Register on May 5, 2010 (effective June 4, 2010).
- <sup>c</sup> On September 25, 2008, EPA redesignated the SJVAB to attainment for the PM10 National Ambient Air Quality Standard (NAAQS) and approved the PM10 Maintenance Plan.
- <sup>d</sup> The SJVAB is designated nonattainment for the 1997 PM2.5 NAAQS. EPA designated the SJVAB as nonattainment for the 2006 PM2.5 NAAQS on November 13, 2009 (effective December 14, 2009).

Over the past decade, ozone levels have been trending downward within the SJVAB and, in 2013, for the first time on record, the air basin overall had zero violations of the federal hourly ozone standard, compared to 281 violations in 1996 (San Joaquin Valley Air Pollution Control District 2014b). At the same time, PM2.5 and PM10 levels have fluctuated with no clear upward or downward trend (California Air Resources Board 2015). Table 2-19 presents the number of days in

which Stanislaus County ozone, PM2.5, and PM10 levels exceeded state and federal air quality standards in 2013 (California Air Resources Board 2015).

**Table 2-19. Stanislaus County Days in Exceedance of State and Federal Air Quality Standards, 2013**

Monitoring Site	Ozone			PM 2.5	PM 10
	# Days > State 1-Hr Standard	# Days > National '08 8-Hr Standard	# Days > State 8-Hr Standard	Est Days > National 24-Hr Standard	Est Days > State 24-Hr Standard
Modesto 14th St.	0	2	13	37.6	57.7
Turlock S. Minaret St.	1	14	24	40.3	73.7

Source: California Air Resources Board 2015.

The 2013 CHA, prepared by the Stanislaus County Health Services Agency, presents data about the health and well-being of Stanislaus County residents, including information on the burden of five major chronic diseases—hypertension, heart disease, stroke, diabetes and asthma—and the environmental and behavioral factors that influence their prevalence. Primary environmental factors identified in the CHA as contributing to these chronic health conditions are air quality and retail food environment; behavioral factors include diet, fast food consumption, fruit and vegetable consumption, quality of clinical care, physical activity, obesity, and tobacco use (Stanislaus County Health Services Agency 2013). As measured in 2007, Stanislaus County has the second worst retail food environment in California, with 5.48 fast-food purveyors and convenience stores for every grocery store or produce vendor near residences, compared to 4.48 statewide, and a high rate of fast food consumption in the low income population (Stanislaus County Health Services Agency 2013). The county also has the highest prevalence of obesity in the state (31.5% compared to 21.2% statewide), particularly among males, and a higher percentage of smokers than the California average (Stanislaus County Health Services Agency 2013).

The CHA presents countywide data and also divides Stanislaus County into nine geographic regions, shown in Table 2-20 below. Monterey Park Tract falls within the south central region identified in Table 2-20.

**Table 2-20. Community Health Assessment of Stanislaus County Geographic Regions**

Region	Communities
Central	Modesto (parts) and outlying areas with ZIP codes 95350, 95355, 95357, and 95358
East Central	Airport Neighborhood and East Modesto (parts) with ZIP code 95354
Southeast Side	Denair, Empire, Hughson, Hickman, La Grange, Waterford with ZIP codes 95316, 95319, 95326, 95323, 95329, and 95386
Northeast Side	Knights Ferry, Valley Home, Oakdale, Riverbank with ZIP codes 95230, 95361, and 95367
North Side	Del Rio, Salida and Modesto (parts) with ZIP codes 95356 and 95368
Southwest Central	West Modesto and South Modesto with ZIP code 95351
West Side	Crows Landing, Grayson, Newman, Patterson with ZIP codes 95313, 95360, 95363, 95385, and 95387
South Central	Ceres, Keyes, Monterey Park Tract with ZIP codes 95307 and 95328
South Side	Turlock with ZIP codes 95380 and 95382

Source: Stanislaus County Health Services Agency 2013:Table 2.

Chronic health conditions of concern within Stanislaus County include hypertension, heart disease, stroke, diabetes and asthma. According to the CHA, the percentage of Stanislaus adults diagnosed with high blood pressure increased 31.2% between 2001 and 2009, and surpassed the percentage of California adults diagnosed with high blood pressure use. As of 2009, approximately 30.7% of Stanislaus County adults were diagnosed with hypertension, compared to 26.2% statewide. Among Stanislaus County's nine regions, the south central region, including Monterey Park Tract, has the fourth-lowest rate of hypertension-related hospitalizations, the second-highest rate of hypertension-related emergency room visits, and the fourth-highest rate of hypertension-related mortality (Stanislaus County Health Services Agency 2013).

The CHA notes that in 2009, 5% of Stanislaus County adults had been diagnosed with heart disease, compared to 5.9% statewide and 12% of adults nationwide. Stanislaus County's south central region has the fourth-lowest rate among the nine regions for heart disease-related emergency room visits, fourth-highest rate of hospitalizations, and third-lowest rate of heart disease-related mortality (Stanislaus County Health Services Agency 2013).

The CHA indicates that the California Health Interview Survey, on which it relies for some data, has not consistently tracked either the overall prevalence of cancer or the rates of individual types of cancer; data for cancer rates is therefore less current than for other, more closely tracked, conditions. Although the percentage of Stanislaus County adults diagnosed with cancer has increased from 7.4% in 2001 to 8.5% in 2005, it remains lower than the statewide rate. However, at a rate of approximately 21.4% of all deaths annually, cancer is the second most common cause of death in Stanislaus County. Stanislaus County's south central region has the fourth-highest rate of cancer-related emergency room visits and hospitalizations among the nine regions, and third-highest rate of cancer-related mortality (Stanislaus County Health Services Agency 2013).

Diabetes, according to the CHA, affects 8.3% of the United States population and is the seventh leading cause of death nationwide. Within California, from 2001 to 2007, the percentage of people diagnosed with diabetes increased from 6.2% to 8.5%, a 37% increase. Trends in Stanislaus County are consistent with the statewide increase; in 2009, 7.6% of adults in Stanislaus County had been

diagnosed with diabetes. While the prevalence of diabetes was lower in Stanislaus County than California, in 2011, Stanislaus County had higher hospitalization rates than California for four primary indicators of diabetes management, including hospitalization for short-term complications, long-term complications, lower-extremity amputation, and uncontrolled diabetes (Stanislaus County Health Services Agency 2013). Among Stanislaus County's nine regions, the south central region has the fourth-highest rate of diabetes-related emergency room visits, the fourth-lowest rate of hospitalizations, and the third-lowest rate of diabetes-related mortality (Stanislaus County Health Services Agency 2013).

According to the CHA, in 2009 the percentage of Stanislaus County adults diagnosed with asthma was 21.8%, compared to 13.5% of the adult population statewide. Among Stanislaus County's nine regions, the south central region ranks fifth for asthma-related emergency room visits and third highest for asthma-related hospitalizations (Stanislaus County Health Services Agency 2013). Due to the low asthma-related death rate, the CHA does not track or rank asthma-related mortality.

The CHA also uses LEB as a measure of quality of life within Stanislaus County and each of its nine regions. LEB is defined as the number of years a newborn infant is projected to live if mortality patterns at the time of its birth were to remain the same throughout its life. The LEB for Stanislaus County is calculated to be 77.2 years, 1.7 years less than the nationwide LEB of 78.9. The LEBs within the nine Stanislaus County regions range from a high of 80.27 years to a low of 75.01 years; the south central region has the fourth-shortest life expectancy, with a LEB of 78.71 (Stanislaus County Health Services Agency 2013).

## 2.5.9 References

Applied Geographic Solutions and Atlas Publisher. 2012. Crime Index for the U.S. Retrieved through ArcGIS. Available: [http://megacity.esri.com/ArcGIS/rest/services/Demographics/USA\\_CrimeIndex/MapServer](http://megacity.esri.com/ArcGIS/rest/services/Demographics/USA_CrimeIndex/MapServer). Accessed: 2012.

California Air Resources Board. 2015. Select 8 Summary. Available: <http://www.arb.ca.gov/adam/select8/sc8start.php>. Accessed: January 22, 2015.

California Department of Conservation. 2012. Division of Land Resource Protection. *Stanislaus County Williamson Act FY 2010/2011, Sheet 1 of 2*. Available: [ftp://ftp.consrv.ca.gov/pub/dlrp/wa/stanislaus\\_north\\_10\\_11\\_WA.pdf](ftp://ftp.consrv.ca.gov/pub/dlrp/wa/stanislaus_north_10_11_WA.pdf). Accessed: January 16, 2015.

California Department of Conservation. 2014. Division of Land Resource Protection. *Rural Land Mapping Edition, Stanislaus County Important Farmland 2012, Sheet 1 of 2*. Available: [ftp://ftp.consrv.ca.gov/pub/dlrp/FMMP/pdf/2012/sta12\\_no.pdf](ftp://ftp.consrv.ca.gov/pub/dlrp/FMMP/pdf/2012/sta12_no.pdf). Accessed: January 16, 2015.

California Department of Education. 2014a. Blaker Kinser Junior High School Profile: Fiscal Year 2013–14. Available: [http://www.ed-data.k12.ca.us/App\\_Resx/EdDataClassic/fsTwoPanel.aspx?#!bottom=/layouts/EdDataClassic/profile.asp?tab=0&level=07&ReportNumber=16&County=50&fyr=1314&District=71043&School=6112346](http://www.ed-data.k12.ca.us/App_Resx/EdDataClassic/fsTwoPanel.aspx?#!bottom=/layouts/EdDataClassic/profile.asp?tab=0&level=07&ReportNumber=16&County=50&fyr=1314&District=71043&School=6112346). Accessed: November 19, 2014.

- California Department of Education. 2014b. Central Valley High School Profile: Fiscal Year 2013–14. Available: [http://www.ed-data.k12.ca.us/App\\_Resx/EdDataClassic/fsTwoPanel.aspx?#!bottom=/layouts/EdDataClassic/profile.asp?tab=0&level=07&ReportNumber=16&County=50&fyr=1314&District=71043&School=0108076](http://www.ed-data.k12.ca.us/App_Resx/EdDataClassic/fsTwoPanel.aspx?#!bottom=/layouts/EdDataClassic/profile.asp?tab=0&level=07&ReportNumber=16&County=50&fyr=1314&District=71043&School=0108076). Accessed: November 19, 2014.
- California Department of Education. 2014c. Westport Elementary School Profile: Fiscal Year 2013–14. Available: [http://www.ed-data.k12.ca.us/App\\_Resx/EdDataClassic/fsTwoPanel.aspx?#!bottom=/layouts/EdDataClassic/profile.asp?tab=0&level=07&ReportNumber=16&County=50&fyr=1314&District=71043&School=6052468](http://www.ed-data.k12.ca.us/App_Resx/EdDataClassic/fsTwoPanel.aspx?#!bottom=/layouts/EdDataClassic/profile.asp?tab=0&level=07&ReportNumber=16&County=50&fyr=1314&District=71043&School=6052468). Accessed: November 19, 2014.
- Ceres Unified School District. 2013. *Elementary School Attendance Boundary Map*. Updated July, 2013. Available: [http://ceres.sharpschool.net/UserFiles/Servers/Server\\_5439645/File/parent%20resources/AttendanceBoundaryMap.pdf](http://ceres.sharpschool.net/UserFiles/Servers/Server_5439645/File/parent%20resources/AttendanceBoundaryMap.pdf). Accessed: November 19, 2014.
- Ceres Unified School District. 2014a. *Information*. Available: <http://www.ceres.k12.ca.us/cms/one.aspx?objectId=5967878>. Accessed: November 19, 2014.
- Ceres Unified School District. 2014b. *Transportation*. Available: [http://www.ceres.k12.ca.us/business\\_services/transportation](http://www.ceres.k12.ca.us/business_services/transportation). Accessed: November 19, 2014.
- City of Ceres. 1997. *City of Ceres General Plan*. Available: <http://www.ci.ceres.ca.us/GeneralPlan.pdf>. Accessed: January 22, 2015.
- City of Ceres. 2010. Park Facility Rental Information. Available: <http://www.ci.ceres.ca.us/3062.html>. Accessed: January 22, 2015.
- Emergency Services Consulting. 2007. *Stanislaus LAFCO Countywide Fire Services Municipal Service Review*. Final Report. March 2007. Prepared for Stanislaus Local Agency Formation Commission. Available: <http://www.stanislauslafco.org/info/FireMSR.htm>. Accessed: August 26, 2014.
- Fremming, Parson & Pecchenino. 2011. *Water Supply Study for the Monterey Park Tract Community Services District*.
- San Joaquin Valley Air Pollution Control District. 2012. *Ambient Air Quality Standards & Valley Attainment Status*. Available: <http://www.valleyair.org/aqinfo/attainment.htm>. Accessed: January 22, 2015.
- San Joaquin Valley Air Pollution Control District. 2014a. *Air Quality in the San Joaquin Valley*. Available: <http://www.valleyair.org/kids/docs/Generalpptforwebsite-2014.pdf>. Accessed: January 22, 2015.
- San Joaquin Valley Air Pollution Control District. 2014b. *Report to the Community, 2013–14 Edition*. Available: <http://www.valleyair.org/2013-14-AnnualReport.pdf>. Accessed: January 22, 2015.
- Stanislaus Council of Governments. 2014. *2014 Regional Transportation Plan / Sustainable Communities Strategy, Stanislaus County*. June 2014. Available: <http://www.stancog.org/pdf/rtp/final-2014-rtpscs.pdf>. Accessed: December 3, 2014.
- Stanislaus County. 2012. *Stanislaus County General Plan Housing Element 2009-2014*. Adopted August 28, 2012.

- Stanislaus County. 2014a. *Solid Waste Management*. Available: <http://www.stancounty.com/ER/solid-waste-ordinance.shtm>. Accessed: November 18, 2014.
- Stanislaus County. 2014b. *Solid Waste Management Franchise Area Map*. Available: <http://www.stancounty.com/ER/pdf/rates/franchiseareamap.pdf>. Accessed: November 18, 2014.
- Stanislaus County. No Date (a). *Community Parks, Facilities, and Fishing Accesses*. Available: <http://www.stancounty.com/er/parks/pdf/community-parks-brochure.pdf>. Accessed: December 10, 2014.
- Stanislaus County. No Date (b). *Parks and Recreation Master Plan Executive Summary*. Available: <http://www.stancounty.com/ER/PARKS/executive-summary.shtm>. Accessed: December 10, 2014.
- Stanislaus County Board of Supervisors. 2015. *Agenda Item C-2, January 13, 2015*. Available: <http://stancounty.com/bos/agenda/2015/20150113/C02.pdf>. Accessed: March 23, 2015.
- Stanislaus County Health Services Agency. 2013. *2013 Stanislaus County Community Health Assessment*.
- Stanislaus County Office of Education. 2009. *Ceres Unified School District Map, Stanislaus County - Fall 2009*. Available: [http://www.stancoe.org/scoe/resources/district\\_maps/Ceres\\_USD.pdf](http://www.stancoe.org/scoe/resources/district_maps/Ceres_USD.pdf). Accessed: July 10, 2014.
- Stanislaus County Sheriff's Department. 2014. *Operations Division*. Available: <http://www.scsdonline.com/operations-division/>. Accessed: November 21, 2014.
- Stanislaus Local Agency Formation Commission. 2010. *Municipal Service Review and Sphere of Influence Update for the Monterey Park Tract Community Services District*. Available: <http://www.stanislauslafco.org/info/PDF/MSR/Districts/MontereyPTCSD.pdf>. Accessed: October 1, 2014.
- Stanislaus Regional Transit. 2014. *System Maps and Quick Guide*. Available: [http://www.srt.org/start\\_system\\_maps2.html](http://www.srt.org/start_system_maps2.html). Accessed: July 10, 2014.
- United States Census Bureau. 1994. *Geographic Areas Reference Manual*. Available: <https://www.census.gov/geo/reference/garm.html>. Accessed: December 8, 2014.
- United States Census Bureau. 2013a. *American Fact Finder DP-1, Profile of General Population and Housing Characteristics 2010, Monterey Park Tract CDP, California*. Available: <http://factfinder.census.gov/faces/nav/jsf/pages/index.xhtml>. Accessed: July 10, 2014.
- United States Census Bureau. 2013b. *American Fact Finder DP03, Selected Economic Characteristics, 2009-2013 American Community Survey 5-Year Estimates, Monterey Park Tract CDP, California*. Available: <http://factfinder.census.gov/faces/nav/jsf/pages/index.xhtml>. Accessed: July 10, 2014.



## 2.6 Riverdale Park Tract

### 2.6.1 General Characteristics and Demographics

The Riverdale Park Tract DUC is an approximately 200-acre rural residential neighborhood with 175 dwelling units, composed primarily of single-family residential units, within the larger Riverdale Park CDP. The Riverdale Park Tract DUC is roughly defined by the Tuolumne River on the north and west, Vivian Road on the east, and West Whitmore Avenue on the south. The Riverdale Park Tract DUC is immediately west of the City of Modesto's sphere of influence, which aligns with Vivian Road, and approximately 1 mile west of Modesto's city limit.

The Riverdale Park Tract CDP also includes a portion of the Riverdale Park Tract that is located within the City of Modesto's sphere of influence and within the boundaries of the Riverdale Park Tract CSD. Because Government Code Section 65302.10 does not consider the area within a city's sphere of influence to be a DUC for county purposes, that portion of the Riverdale Park Tract is not the subject of this analysis.

The Riverdale Park Tract DUC consists of five census blocks within the Riverdale Park CDP. The CDP had a 2010 census population of approximately 1,128 people in 354 households. In 2013, California's median annual household income was \$60,190; in the Riverdale Park Tract it was \$37,656 (United States Census Bureau 2011, 2013a, 2013b). The DUC had a 2010 census population of 607 people in 164 households, for an average household size of 3.7 people (United States Census Bureau n.d.).

The General Plan's Housing Element identifies Riverdale Park Tract as a Residential Development Potential Study Area; however, the geographic area identified in the Housing Element is northeast and independent of the DUC area considered in this document (Stanislaus County 2012). Existing infrastructure and services for the Riverdale Park Tract DUC are limited and are described below.

### 2.6.2 Infrastructure, Utilities, and Services

Infrastructure, utilities, and services considered for the Riverdale Park Tract DUC are presented in Figure 2-6, *Riverdale Park Tract Disadvantaged Unincorporated Community*, and include transportation facilities and services including roads, sidewalks, street lighting, and bus stops/service; water, wastewater, and storm drainage systems; solid waste disposal; public safety services such as law enforcement and fire protection; and access to community amenities and services such as schools, parks, and grocery stores. Data associated with chronic health conditions and air quality are described at a regional level because they are not available specifically for the Riverdale Park Tract DUC.

### 2.6.3 Transportation Facilities and Services

The Riverdale Park Tract DUC lies approximately 4 miles west of SR 99, a major north-south travel corridor and a six-lane freeway in Stanislaus County. Transportation infrastructure in the immediate Riverdale Park Tract vicinity consists entirely of two-lane local roadways with no curbs, gutters, sidewalks, or streetlights. The nearest two-lane major roadway is Carpenter Road, 1 mile east of the DUC (Stanislaus Council of Governments 2014). The County General Plan designates this segment of

Carpenter Road as a six-lane expressway, intended to move high volumes of people and goods between urban areas within the county (Stanislaus County 2006).

Most of the Riverdale Park Tract DUC falls immediately outside the service areas of three public StaRT shuttle services, the Eastside Shuttle, the Turlock/Modesto Shuttle, and the Waterford/Modesto Runabout (Stanislaus Regional Transit 2014). All of these StaRT shuttles provide curb-to-curb service within designated areas by advance reservation of at least 4 hours, and the Waterford/Modesto Runabout combines curb-to-curb service with several designated fixed stops (Stanislaus Regional Transit 2014). Vivian Road, the easternmost road of the DUC, serves as the western boundary of the Eastside and Turlock/Modesto shuttles, and Hatch Road, which terminates at the northern end of the DUC, forms the southern boundary of the Waterford/Modesto Runabout (Stanislaus Regional Transit 2014).

## 2.6.4 Water, Wastewater, and Stormwater Drainage Systems

No CSD or CSA serves the Riverdale Park Tract DUC. Domestic water within the DUC is provided by individual private wells, and wastewater is disposed through private septic systems. No storm drainage system serves the Riverdale Park Tract DUC.

The Riverdale Park Tract CSD operates a well and storage tanks that provide domestic water services to the residents of the unincorporated community northeast of the DUC between the Tuolumne River and West Hatch Road and contracts with the City of Modesto for its emergency water supply (Stanislaus Local Agency Formation Commission 2011). The Riverdale Park Tract CSD does not serve the Riverdale Park Tract DUC. Its boundary and sphere of influence are coterminous and encompass 58 acres located northeast of the DUC. The CSD's western boundary is 0.3 mile east of the northeastern edge of the DUC (Stanislaus Local Agency Formation Commission 2011).

## 2.6.5 Solid Waste Disposal

Stanislaus County contracts with four franchised solid waste collection companies, Bertolotti Disposal, Gilton Solid Waste, Modesto Disposal/Waste Management, and Turlock Scavenger, for residential and commercial garbage collection service in the unincorporated area (Stanislaus County 2014a). Riverdale Park Tract falls within County-designated Franchise Area 1, served by Bertolotti Disposal (Stanislaus County 2014b). Besides providing solid waste and recyclables collection services to Franchise Area 1, Bertolotti Disposal operates a transfer station, open to the public Mondays through Saturdays, on Flamingo Road in Ceres. Additionally, Stanislaus County's Fink Road Sanitary Landfill, a Class III landfill for nonhazardous municipal solid waste, is operated by the County's Department of Environmental Resources and is open Monday–Saturday to private citizens, school districts, businesses, and local agencies for individual disposal of solid waste (Stanislaus County 2014c).

## 2.6.6 Law Enforcement and Fire Protection

Law enforcement services for Riverdale Park Tract, as for the rest of unincorporated Stanislaus County and four contract cities, are provided by the Stanislaus County Sheriff's Department. The operations division of the Sheriff's Department provides law enforcement services to over 200,000 people in a 1,521-square-mile area (Stanislaus County Sheriff's Department 2014). Two units—patrol and investigations—comprise the Sheriff's Department operations division. The patrol unit

Path: K:\Projects\_1\County\_of\_Stanslaus\00203\_10\_DAC\mapdoc\DCos\Fig2\_ServicesA.mxd; User: 19393; Date: 6/9/2015



**Figure 2-6**  
**Riverdale Park Tract Disadvantaged Unincorporated Community**



***THIS PAGE INTENTIONALLY LEFT BLANK***

responds to calls for assistance, investigates crime, makes arrests, and performs preventive patrol services (Stanislaus County Sheriff's Department 2014). The investigations unit follows up reports of major crimes, collects and prepares evidence for trials, apprehends offenders, and recovers stolen property (Stanislaus County Sheriff's Department 2014). The nearest sheriff's station to Riverdale Park Tract is the main station, approximately 3.5 miles southeast at 250 East Hackett Road in Ceres.

The crime rates presented below were compiled by AGS using the primary reporting categories from the FBI 2005 – 2010 Uniform Crime Report databases along with preliminary 2011 release data and census data related to socioeconomic characteristics. The crimes are divided into two main categories, personal crimes (murder, rape, robbery, and assault) and property crimes (burglary, larceny, and motor vehicle theft). These crime rates are based on a comparison of the average local crime rate to the national average for the same crime, with a crime index of 100 considered average; scores above 100 are therefore considered greater, or worse, than average. For example, a score of 130 would represent a crime rate 30% greater than the national average for that type of crime. These crime rates are unweighted (i.e., a murder and a theft carry the same weight for calculation purposes), and are tracked at the census block group level and above, which may not correspond precisely to the DUC boundaries. Census blocks are the smallest geographic area for which the United States Census Bureau collects and tabulates data; a set of these constitutes a census block group. Census blocks vary widely in geographic size, and are generally smaller in urban areas and progressively larger in suburban, rural, or remote areas; a given block group is larger in area and population than the individual census blocks of which it is made, and generally contains between 600 and 3,000 people (United States Census Bureau 1994). The Riverdale Park Tract DUC falls within two large census block groups. Most of the DUC parcels and population, east of Poland Road, fall within census block group 060990031.002; the area west of Poland Road falls within census block group 060990031.003.

The overall personal crime and property crime indices for most of the Riverdale Park Tract DUC (census block group 060990031.002) are 173 and 124, respectively, which means that personal crimes in that area occur at a rate 73% higher than the nationwide average, and property crimes occur at a rate 24% above national average. For the western portion of the DUC (census block group 060990031.003), the overall personal crime and property crime indices are 184 and 166. The general and individual crime indices for these categories are shown in Table 2-21 below.

**Table 2-21. Riverdale Park Tract DUC Crime Indices**

Block Group	Personal Crime		Block Group	Property Crime	
	060990031.002	060990031.003		060990031.002	060990031.003
Personal Crime Index	173	184	Property Crime Index	124	166
Murder	230	112	Burglary	245	329
Rape	95	117	Larceny	136	182
Robbery	50	65	Motor Vehicle Theft	19	26
Assault	273	375			

Source: Applied Geographic Solutions and Atlas Publishing 2012.

The Burbank-Paradise FPD provides fire protection and emergency response services to the Riverdale Park Tract DUC and surrounding area from its one fire station, located approximately 2.5 miles northeast on Beverly Drive in Modesto. The Burbank-Paradise FPD fire station serves a 5.5-square-mile area with a staff of 6 paid and 30 volunteer firefighters, and it houses three structure fire engines and one wildland fire engine (Emergency Services Consulting 2007). The station's workload, defined by the number of incidents per year, increased from just under 300 in 1987 to over 800 in 2005 (Emergency Services Consulting 2007).

A fire department's ability to meet the fire protection needs of its service area is typically evaluated by the Insurance Services Office (ISO), a private organization that assesses risks, including fire protection, for insurance purposes. The ISO considers a variety of factors, including a district's fire-fighting apparatus, staffing, training, location, and water supply, to rate fire departments on a scale from 1 (best fire protection possible) to 10 (no fire protection). The ISO rating therefore reflects a fire department's ability to protect the residents and businesses within its service area from fire. The Burbank-Paradise FPD has an ISO rating of 5 in hydrant-served areas and 8 in non-hydrant areas within its district boundaries (Emergency Services Consulting 2007).

## 2.6.7 Schools and Community Amenities

Riverdale Park Tract lies within the boundaries of the Modesto City School District, which is a common administration district comprised of the Modesto City Elementary and Modesto City High School districts (Modesto City Schools 2015). Modesto City Elementary District includes a total of 26 schools serving students in grades K–8. Modesto City High School District serves students in grades 9–12. The nearest elementary school to which K–6 students from Riverdale Park Tract are assigned is Fairview Elementary, which is about 1.5 miles east of the Riverdale Park Tract DUC. Fairview Elementary serves 878 students (California Department of Education 2014b). Fairview Preschool and Head Start are also located on the Fairview Elementary campus. The nearest middle school to Riverdale Park Tract is Evelyn Hanshaw Middle School, approximately 2.5 miles east in Modesto, serving 789 students in grades 7 and 8 (California Department of Education 2014a). The Riverdale Park Tract DUC falls within the attendance zone for Thomas Downey High School, located approximately 6 miles northwest in Modesto. Thomas Downey High School serves 1,974 students in grades 9–12 (California Department of Education 2014c). Modesto City Schools buses elementary students living more than 1 mile from their school, middle school students living more than 2 miles from their school, and high school students living more than 3 miles from their school (Modesto City Schools 2015).

There are no public parks within the Riverdale Park Tract DUC. Nearby parks and recreation facilities include the Riverdale Park and Fishing Access and Fairview Park. The Riverdale Park and Fishing Access is located approximately 0.5 mile northeast of the DUC on the south side of the Tuolumne River at Parkdale Drive. The 3-acre Riverdale Park and Fishing Access features play structures, informal play areas, a picnic shelter and picnic tables, benches, a drinking fountain, a walking trail, parking, and a carry-in boat path to the river, but there are no restroom facilities (Stanislaus County n.d.). Fairview Park, located approximately 1.8 miles east of the Riverdale Park Tract DUC in southwest Modesto near West Whitmore and Tucson Avenues, occupies 4 acres and includes a baseball/softball field, a basketball court, a picnic shelter, picnic tables with barbecues, and informal play areas (Stanislaus County n.d.).

There are no grocery stores in Riverdale Park Tract. The nearest grocery store to Riverdale Park Tract is the Country Market, a small convenience market, approximately 0.75 mile east of the DUC

on West Hatch Road near Woodlane Avenue. The Fairview Market, another small convenience market, is about 2 miles east of the Riverdale Park Tract DUC on Inyo Avenue. The nearest full-service supermarkets are La Perla Tapatia and Mi Pueblo Food Center, both approximately 3.2 miles east of Riverdale Park Tract in Modesto.

## 2.6.8 Air Quality and Chronic Health Conditions

Stanislaus County is within the northern part of the eight-county SJVAPCD, the regional public health agency responsible for air quality management in those 8 counties. SJVAPCD cites several factors that contribute to the valley's air quality challenges, including high rates of chronic poverty and unemployment coupled with a high population growth rate, the presence of major transportation corridors, and topographic features such as the surrounding mountains combined with the area's meteorological conditions (San Joaquin Valley Air Pollution Control District 2014a). SJVAPCD notes that ozone, PM10, and PM2.5 are of special concern, causing or exacerbating a variety of health conditions (San Joaquin Valley Air Pollution Control District 2014a). The presence of PM2.5, primarily a winter condition, triggers heart attacks, asthma, bronchitis, and respiratory infections, and has a strong correlation with hospital admissions and deaths (San Joaquin Valley Air Pollution Control District 2014a).

GHGs are not a criteria air pollutant and do not directly affect human health. GHG emissions are largely the result of combustion, decay and digestive processes, and emissions of industrial gases with high climate change potential. Unlike criteria pollutants such as carbon monoxide, PM10, PM2.5, and ozone, GHGs do not collect within a specific area or air basin. Their harm is done at a global level through the effect of increased concentrations of GHGs in Earth's atmosphere.

Worldwide concern over GHG emissions is based on the climate change that they are causing by altering the way in which Earth's atmosphere traps solar radiation as heat. The adverse effects of global climate change include rising sea levels, changes in habitat conditions for plants and animals, increased potential for wildfires, more severe weather extremes, and a reduction in California's winter snow pack, among others. Through the impetus of AB 32 (California Global Warming Solutions Act of 2006) and other legislation, California has undertaken a statewide program of reducing GHG emissions to 1990 levels by 2020 in order to slow the rate of global climate change.

Climate change can have an indirect effect on human health in Stanislaus County to the extent that it results in warmer summer temperatures that facilitate ozone formation and exacerbate heat-related stress among outdoor workers, the elderly, small children, and the infirm. The amount of GHGs emitted within the Riverdale Park Tract DUC is not atypical for a small, largely residential community.

SJVAPCD operates 36 air monitoring sites within its eight-county air basin. Of these, two air quality stations, one in Modesto and another in Turlock, monitor air quality within Stanislaus County. The Modesto monitoring site, approximately 3.6 miles to the northeast, is the closest monitoring station to Riverdale Park Tract. Table 2-22 shows the SJVAB's current air quality attainment status for state and federal criteria pollutants (San Joaquin Valley Air Pollution Control District 2012).

**Table 2-22. San Joaquin Valley Air Basin Air Quality Attainment Status**

Pollutant	Designation/Classification	
	Federal Standards	State Standards
Ozone—1-hour	No Federal Standard <sup>a</sup>	Nonattainment/Severe
Ozone—8-hour	Nonattainment/Extreme <sup>b</sup>	Nonattainment
PM 10	Attainment <sup>c</sup>	Nonattainment
PM 2.5	Nonattainment <sup>d</sup>	Nonattainment
Carbon monoxide	Attainment/Unclassified	Attainment/Unclassified
Nitrogen dioxide	Attainment/Unclassified	Attainment
Sulfur dioxide	Attainment/Unclassified	Attainment
Lead (particulate)	No Designation/Classification	Attainment
Hydrogen sulfide	No Federal Standard	Unclassified
Sulfates	No Federal Standard	Attainment
Visibility reducing particles	No Federal Standard	Unclassified
Vinyl chloride	No Federal Standard	Attainment

Source: San Joaquin Valley Air Pollution Control District 2012.

- <sup>a</sup> Effective June 15, 2005, the U.S. Environmental Protection Agency (EPA) revoked the federal 1-hour ozone standard, including associated designations and classifications. EPA had previously classified the San Joaquin Valley air basin (SJVAB) as extreme nonattainment for this standard. EPA approved the 2004 Extreme Ozone Attainment Demonstration Plan on March 8, 2010 (effective April 7, 2010). Many applicable requirements for extreme 1-hour ozone nonattainment areas continue to apply to the SJVAB.
- <sup>b</sup> Though the Valley was initially classified as serious nonattainment for the 1997 8-hour ozone standard, EPA approved Valley reclassification to extreme nonattainment in the Federal Register on May 5, 2010 (effective June 4, 2010).
- <sup>c</sup> On September 25, 2008, EPA redesignated the SJVAB to attainment for the PM10 National Ambient Air Quality Standard (NAAQS) and approved the PM10 Maintenance Plan.
- <sup>d</sup> The SJVAB is designated nonattainment for the 1997 PM2.5 NAAQS. EPA designated the SJVAB as nonattainment for the 2006 PM2.5 NAAQS on November 13, 2009 (effective December 14, 2009).

Over the past decade, ozone levels have been trending downward within the SJVAB and, in 2013, for the first time on record, the air basin overall had zero violations of the federal hourly ozone standard, compared to 281 violations in 1996 (San Joaquin Valley Air Pollution Control District 2014b). At the same time, PM2.5 and PM10 levels have fluctuated with no clear upward or downward trend (California Air Resources Board 2015). Table 2-23 presents the number of days in which Stanislaus County ozone, PM2.5, and PM10 levels exceeded state and federal air quality standards in 2013 (California Air Resources Board 2015).



**Table 2-23. Stanislaus County Days in Exceedance of State and Federal Air Quality Standards, 2013**

Monitoring Site	Ozone			PM 2.5	PM 10
	# Days > State 1-Hr Standard	# Days > National '08 8-Hr Standard	# Days > State 8-Hr Standard	Est Days > National 24-Hr Standard	Est Days > State 24-Hr Standard
Modesto 14th St.	0	2	13	37.6	57.7
Turlock S. Minaret St.	1	14	24	40.3	73.7

Source: California Air Resources Board 2015.

The 2013 CHA, prepared by the Stanislaus County Health Services Agency, presents data about the health and well-being of Stanislaus County residents, including information on the burden of five major chronic diseases—hypertension, heart disease, stroke, diabetes and asthma—and the environmental and behavioral factors that influence their prevalence. Primary environmental factors identified in the CHA as contributing to these chronic health conditions are air quality and retail food environment; behavioral factors include diet, fast food consumption, fruit and vegetable consumption, quality of clinical care, physical activity, obesity, and tobacco use (Stanislaus County Health Services Agency 2013). As measured in 2007, Stanislaus County has the second worst retail food environment in California, with 5.48 fast-food purveyors and convenience stores for every grocery store or produce vendor near residences, compared to 4.48 statewide, and a high rate of fast food consumption in the low income population (Stanislaus County Health Services Agency 2013). The county also has the highest prevalence of obesity in the state (31.5% compared to 21.2% statewide), particularly among males, and a higher percentage of smokers than the California average (Stanislaus County Health Services Agency 2013).

The CHA presents countywide data and also divides Stanislaus County into nine geographic regions, shown in Table 2-24 below. The Riverdale Park Tract DUC falls within the central region identified in Table 2-24.

**Table 2-24. Community Health Assessment of Stanislaus County Geographic Regions**

Region	Communities
Central	Modesto (parts) and outlying areas, including Riverdale Park, with ZIP codes 95350, 95355, 95357, and 95358
East Central	Airport Neighborhood and East Modesto (parts) with ZIP code 95354
Southeast Side	Denair, Empire, Hughson, Hickman, La Grange, Waterford with ZIP codes 95316, 95319, 95326, 95323, 95329, and 95386
Northeast Side	Knights Ferry, Valley Home, Oakdale, Riverbank with ZIP codes 95230, 95361, and 95367
North Side	Del Rio, Salida and Modesto (parts) with ZIP codes 95356 and 95368
Southwest Central	West Modesto and South Modesto with ZIP code 95351
West Side	Crows Landing, Grayson, Newman, Patterson with ZIP codes 95313, 95360, 95363, 95385, and 95387
South Central	Ceres, Keyes with ZIP codes 95307 and 95328
South Side	Turlock with ZIP codes 95380 and 95382

Source: Stanislaus County Health Services Agency 2013:Table 2.

Chronic health conditions of concern within Stanislaus County include hypertension, heart disease, stroke, diabetes and asthma. According to the CHA, the percentage of Stanislaus adults diagnosed with high blood pressure increased 31.2% between 2001 and 2009, and surpassed the percentage of California adults diagnosed with high blood pressure use. As of 2009, approximately 30.7% of Stanislaus County adults were diagnosed with hypertension, compared to 26.2% statewide. Among Stanislaus County's nine regions, the central region ranks fifth for hypertension-related emergency room visits, has the fourth-highest rate of hypertension-related hospitalizations, and ranks fifth for hypertension-related mortality (Stanislaus County Health Services Agency 2013).

The CHA notes that in 2009, 5% of Stanislaus County adults had been diagnosed with heart disease, compared to 5.9% statewide and 12% of adults nationwide. The central region of Stanislaus County, including Riverdale Park Tract, ranks third lowest among the nine regions for heart disease-related emergency room visits, has the fourth-lowest rate of heart disease-related hospitalizations, and has the third-highest rate of heart disease-related mortality (Stanislaus County Health Services Agency 2013).

The CHA indicates that the California Health Interview Survey, on which it relies for some data, has not consistently tracked either the overall prevalence of cancer or the rates of individual types of cancer; data for cancer rates is therefore less current than for other, more closely tracked, conditions. Although the percentage of Stanislaus County adults diagnosed with cancer has increased from 7.4% in 2001 to 8.5% in 2005, it remains lower than the statewide rate. However, at a rate of approximately 21.4% of all deaths annually, cancer is the second most common cause of death in Stanislaus County. The central region of Stanislaus County has the fourth-lowest rate of cancer-related emergency room visits among the county's nine regions ranks fifth for cancer-related hospitalizations, and has the fourth-highest rate of cancer-related mortality (Stanislaus County Health Services Agency 2013).

Diabetes, according to the CHA, affects 8.3% of the United States population and is the seventh leading cause of death nationwide. Within California, from 2001-2007, the percentage of people diagnosed with diabetes increased from 6.2% to 8.5%, a 37% increase. Trends in Stanislaus County are consistent with the statewide increase; in 2009, 7.6% of adults in Stanislaus County had been diagnosed with diabetes. While the prevalence of diabetes was lower in Stanislaus County than California, in 2011, Stanislaus County had higher hospitalization rates than California for four primary indicators of diabetes management, including hospitalization for short-term complications, long-term complications, lower-extremity amputation, and uncontrolled diabetes (Stanislaus County Health Services Agency 2013). Among Stanislaus County's nine regions, the central region ranks fifth for diabetes-related emergency room visits and hospitalizations, and has the fourth-highest rate of diabetes-related mortality (Stanislaus County Health Services Agency 2013).

According to the CHA, in 2009 the percentage of Stanislaus County adults diagnosed with asthma was 21.8%, compared to 13.5% of the adult population statewide. Among the county's nine geographic regions, the central region has the third-highest rate of asthma-related emergency room visits and ranks fifth for asthma-related hospitalizations (Stanislaus County Health Services Agency 2013). Due to the low asthma-related death rate, the CHA does not track or rank asthma-related mortality.

The CHA also uses LEB as a measure of quality of life within Stanislaus County and each of its nine regions. LEB is defined as the number of years a newborn infant is projected to live if mortality patterns at the time of its birth were to remain the same throughout its life. The LEB for Stanislaus

County is calculated to be 77.2 years, 1.7 years less than the nationwide LEB of 78.9. The LEBs within the nine regions range from a high of 80.27 years to a low of 75.01 years; the area encompassing the Riverdale Park Tract DUC has the second-shortest LEB, 77.73 years (Stanislaus County Health Services Agency 2013).

## 2.6.9 References

- Applied Geographic Solutions and Atlas Publisher. 2012. Crime Index for the U.S. Retrieved through ArcGIS. Available: [http://megacity.esri.com/ArcGIS/rest/services/Demographics/USA\\_CrimeIndex/MapServer](http://megacity.esri.com/ArcGIS/rest/services/Demographics/USA_CrimeIndex/MapServer). Accessed: 2012.
- California Air Resources Board. 2015. Select 8 Summary. Available: <http://www.arb.ca.gov/adam/select8/sc8start.php>. Accessed: January 22, 2015.
- California Department of Education. 2014a. *Evelyn Hanshaw Middle School Profile: Fiscal Year 2013–14*. Available: [http://www.ed-data.k12.ca.us/App\\_Resx/EdDataClassic/fsTwoPanel.aspx?#!bottom=/layouts/EdDataClassic/profile.asp?tab=0&level=07&ReportNumber=16&County=50&fyr=1314&District=71167&School=6110068](http://www.ed-data.k12.ca.us/App_Resx/EdDataClassic/fsTwoPanel.aspx?#!bottom=/layouts/EdDataClassic/profile.asp?tab=0&level=07&ReportNumber=16&County=50&fyr=1314&District=71167&School=6110068). Accessed: March 13, 2015.
- California Department of Education. 2014b. *Fairview Elementary School Profile: Fiscal Year 2013–14*. Available: [http://www.ed-data.k12.ca.us/App\\_Resx/EdDataClassic/fsTwoPanel.aspx?#!bottom=/layouts/EdDataClassic/profile.asp?tab=0&level=07&ReportNumber=16&County=50&fyr=1314&District=71167&School=6052682](http://www.ed-data.k12.ca.us/App_Resx/EdDataClassic/fsTwoPanel.aspx?#!bottom=/layouts/EdDataClassic/profile.asp?tab=0&level=07&ReportNumber=16&County=50&fyr=1314&District=71167&School=6052682). Accessed: March 13, 2015.
- California Department of Education. 2014c. *Thomas Downey High School Profile: Fiscal Year 2013–14*. Available: [http://www.ed-data.k12.ca.us/App\\_Resx/EdDataClassic/fsTwoPanel.aspx?#!bottom=/layouts/EdDataClassic/profile.asp?tab=0&level=07&ReportNumber=16&County=50&fyr=1314&District=71175&School=5031802](http://www.ed-data.k12.ca.us/App_Resx/EdDataClassic/fsTwoPanel.aspx?#!bottom=/layouts/EdDataClassic/profile.asp?tab=0&level=07&ReportNumber=16&County=50&fyr=1314&District=71175&School=5031802). Accessed: March 13, 2015.
- Emergency Services Consulting. 2007. *Stanislaus LAFCO Countywide Fire Services Municipal Service Review*. Final Report. March 2007. Prepared for Stanislaus Local Agency Formation Commission. Available: <http://www.stanislauslafco.org/info/FireMSR.htm>. Accessed: August 26, 2014.
- Modesto City Schools. 2015. *Attendance Boundaries*. Available: <https://www.mcs4kids.com/district/schools/attendance-boundaries>. Accessed: March 13, 2015.
- San Joaquin Valley Air Pollution Control District. 2012. *Ambient Air Quality Standards & Valley Attainment Status*. Available: <http://www.valleyair.org/aqinfo/attainment.htm>. Accessed: January 22, 2015.
- San Joaquin Valley Air Pollution Control District. 2014a. *Air Quality in the San Joaquin Valley*. Available: <http://www.valleyair.org/kids/docs/Generalpptforwebsite-2014.pdf>. Accessed: January 22, 2015.
- San Joaquin Valley Air Pollution Control District. 2014b. *Report to the Community, 2013–14 Edition*. Available: <http://www.valleyair.org/2013-14-AnnualReport.pdf>. Accessed: January 22, 2015.

- Stanislaus Council of Governments. 2014. *2014 Regional Transportation Plan / Sustainable Communities Strategy, Stanislaus County*. June 2014. Available: <http://www.stancog.org/pdf/rtp/final-2014-rtpscs.pdf>. Accessed: December 3, 2014.
- Stanislaus County. 2012. *Stanislaus County General Plan Housing Element 2009-2014*. Adopted August 28, 2012.
- Stanislaus County. 2014a. *Solid Waste Management*. Available: <http://www.stancounty.com/ER/solid-waste-ordinance.shtm>. Accessed: November 18, 2014.
- Stanislaus County. 2014b. *Solid Waste Management Franchise Area Map*. Available: <http://www.stancounty.com/ER/pdf/rates/franchiseareamap.pdf>. Accessed: November 18, 2014.
- Stanislaus County. 2014c. *Landfill Division: Fink Road Sanitary Landfill*. Available: <http://www.stancounty.com/ER/landfill-division.shtm>. Accessed: November 18, 2014.
- Stanislaus County. No Date. *Community Parks, Facilities, and Fishing Accesses*. Available: <http://www.stancounty.com/er/parks/pdf/community-parks-brochure.pdf>. Accessed: December 10, 2014.
- Stanislaus County Health Services Agency. 2013. *2013 Stanislaus County Community Health Assessment*.
- Stanislaus County Sheriff's Department. 2014. *Operations Division*. Available: <http://www.scsdonline.com/operations-division/>. Accessed: November 21, 2014.
- Stanislaus Local Agency Formation Commission. 2011. *Municipal Service Review and Sphere of Influence Update for the Riverdale Park Tract Community Services District*. Available: <http://www.stanislauslafco.org/info/PDF/MSR/Districts/RiverdalePTCSD.pdf>. Accessed: March 13, 2015.
- Stanislaus Regional Transit. 2014. *System Maps and Quick Guide*. Available: [http://www.srt.org/start\\_system\\_maps2.html](http://www.srt.org/start_system_maps2.html). Accessed: July 10, 2014.
- United States Census Bureau. 1994. *Geographic Areas Reference Manual*. Available: <https://www.census.gov/geo/reference/garm.html>. Accessed: December 8, 2014.
- United States Census Bureau. 2011. *2010 Census - Census Block Map: Riverdale Park CDP, California*. Available: [http://www2.census.gov/geo/maps/dc10map/GUBlock/st06\\_ca/place/p0661106\\_riverdale\\_park/DC10BLK\\_P0661106\\_001.pdf](http://www2.census.gov/geo/maps/dc10map/GUBlock/st06_ca/place/p0661106_riverdale_park/DC10BLK_P0661106_001.pdf). Accessed: December 8, 2014.
- United States Census Bureau. 2013a. *American Fact Finder DP-1, Profile of General Population and Housing Characteristics 2010, Riverdale Park CDP, California*. Available: <http://factfinder.census.gov/faces/nav/jsf/pages/index.xhtml>. Accessed: July 10, 2014.
- United States Census Bureau. 2013b. *American Fact Finder DP03, Selected Economic Characteristics, 2009-2013 American Community Survey 5-Year Estimates, Riverdale Park CDP, California*. Available: <http://factfinder.census.gov/faces/nav/jsf/pages/index.xhtml>. Accessed: July 10, 2014.

United States Census Bureau. No Date. *2010 Census Interactive Population Map*. Available:  
<https://www.census.gov/2010census/popmap/>. Accessed: March 13, 2015.

***THIS PAGE INTENTIONALLY LEFT BLANK***

## 2.7 Westley

### 2.7.1 General Characteristics and Demographics

Westley is an unincorporated community located roughly 5.5 miles north of the city of Patterson in western Stanislaus County. At 1,116 acres, the Westley CDP occupies a much larger area than the 107-acre area identified as the Westley DUC, and encompasses approximately 1,000 acres of agricultural lands immediately west and northwest of the DUC. These agricultural lands are identified by the California Department of Conservation's Important Farmlands Inventory as prime farmland (California Department of Conservation 2014). Most of the area immediately north of the DUC is under Williamson Act contract (California Department of Conservation 2012). These agricultural lands do not support the requisite level of existing development for consideration under SB 244 and are unlikely to develop; therefore, they are not included as part of the Westley DUC studied for SB 244 purposes.

The Westley DUC has a population of approximately 603 people in 149 households. In 2013, the median annual household income in California was \$60,190; it was \$24,762 in the Westley DUC (United States Census Bureau 2013a, 2013b). Westley DUC is defined by E Street on the north, State Highway 33 on the east, Howard Road on the south, and roughly encompassing the Westley Migrant Center on the west. In addition to residential uses, Westley features a variety of commercial and public uses, including agricultural packing and shipping operations, commercial uses clustered along and near Highway 33 and the Union Pacific Railroad tracks, as well as a fire station, an elementary school, and a United States Post Office. Westley is surrounded by orchards and agriculture-related structures and is roughly bordered on the east by the Union Pacific Railroad tracks and the Westside Irrigation District (WSID) South Lateral canal. Residential uses in Westley consist of single-family residential units and the Stanislaus County Housing Authority's 88-unit Westley Migrant Center housing complex (Stanislaus County 2012; Stanislaus Local Agency Formation Commission 2014).

The General Plan's Housing Element identifies Westley as a Residential Development Potential Study Area and indicates that it has the capacity to accommodate only one more dwelling unit (Stanislaus County 2012). Existing infrastructure and services for Westley are described below.

### 2.7.2 Infrastructure, Utilities, and Services

Infrastructure, utilities, and services considered for the Westley DUC are presented in Figure 2-7, *Westley Disadvantaged Unincorporated Community*, and include transportation facilities and services including roads, sidewalks, street lighting, and bus stops/service; water, wastewater, and storm drainage systems; solid waste disposal; public safety services such as law enforcement and fire protection; and access to community amenities and services such as schools, parks, and grocery stores. Data associated with chronic health conditions and air quality are described at a regional level because they are not available specifically for the Westley DUC.

### 2.7.3 Transportation Facilities and Services

Transportation infrastructure in Westley consists of public highways and roads, railroad tracks, a small private airport, and StaRT bus service. Major north-south highways serving western Stanislaus County include I-5 and Highway 33. Westley lies approximately 3 miles east of I-5. SR 33 and the Union Pacific Railroad tracks run northwest-southeast along the eastern side of Westley. SR 33 is a

***THIS PAGE INTENTIONALLY LEFT BLANK***



Path: K:\Projects\_1\County\_of\_Stanslaus\00203\_10\_DAC\mapdoc\IDUCs\Fig2\_ServicesA.mxd; User: 19393; Date: 6/9/2015

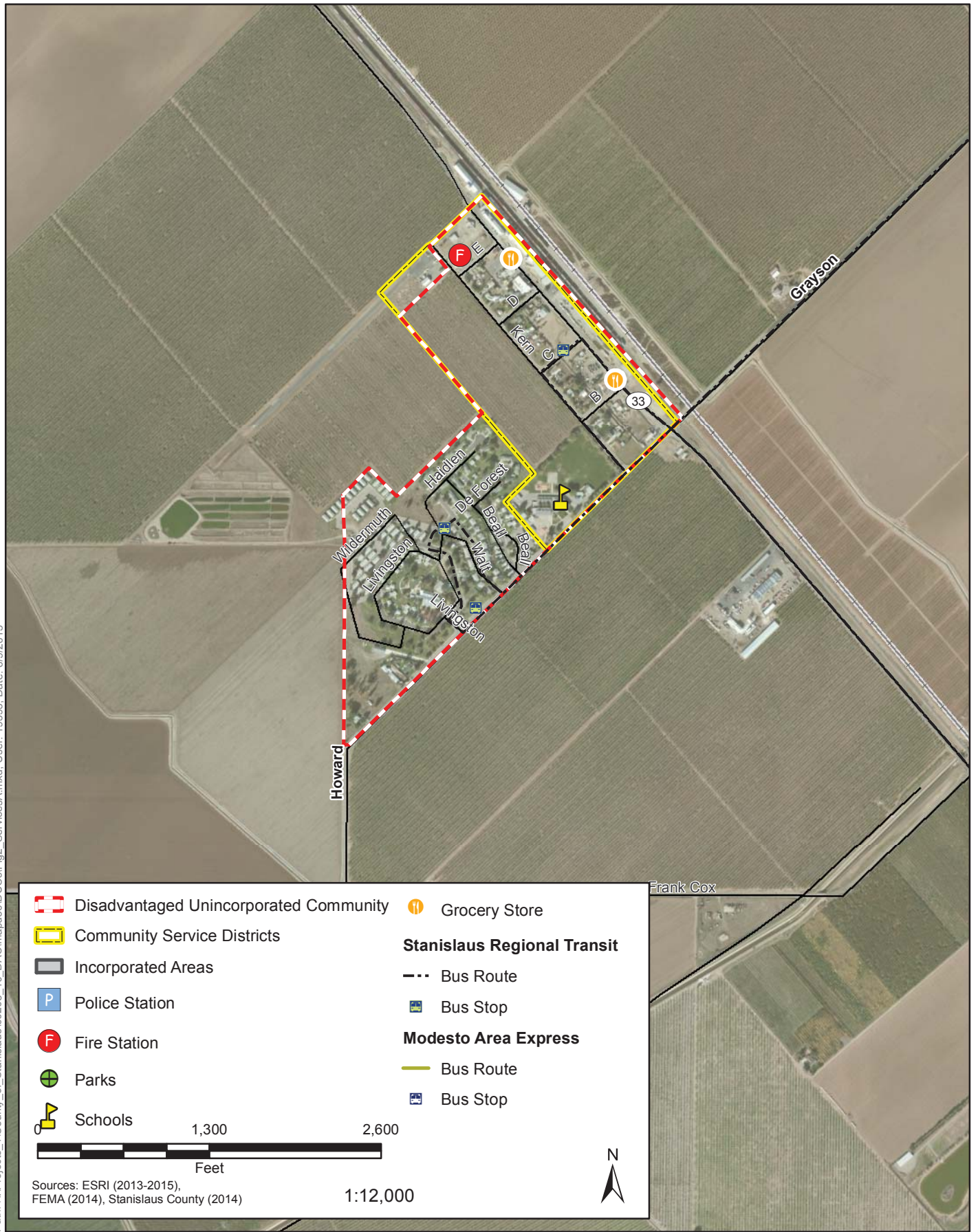

**Figure 2-7**  
**Westley Disadvantaged Unincorporated Community**

***THIS PAGE INTENTIONALLY LEFT BLANK***

two-lane undivided highway through Westley, with a four-way stop at its intersection with Howard Road. SR 33 is designated as a four-lane expressway by the County General Plan (Stanislaus County 2006). Expressways are intended to move high volumes of people and goods between urban areas within the county (Stanislaus County 2006). Howard Road is currently a two-lane major road designated as a four-lane expressway in the County General Plan (Stanislaus Council of Governments 2014; Stanislaus County 2006). All other roads within Westley are two-lane local roadways. No curbs, gutters, or sidewalks are present in the eastern portion of Westley; however, the streets around Grayson Charter School and the Westley Migrant Center feature sidewalks, curbs, gutters, and above-ground drainage ditches. Street lights, provided by the Westley CSD are present at several intersections, primarily along SR 33 and along Howard Road, as well as along the streets of the Westley Migrant Center. The Westley Airport, located along the northern edge of Westley, is a private airport owned by Valley Crop Dusters and used primarily by crop dusting aircraft (Great Circle Mapper 2015).

Fixed-route bus service on StaRT Route 40 connects Westley to Modesto, Grayson, and Patterson (Stanislaus Regional Transit 2014a). StaRT Route 40 provides round trips between Modesto and Patterson; Monday–Friday, there are eight round trips, running approximately every 2 hours from 5:20 a.m. to 9:08 p.m.; on Saturdays, there are five round trips, running every 2 hours and 45 minutes from 8:15 a.m. to 8:12 p.m.; no StaRT buses run on Route 40 on Sundays (Stanislaus Regional Transit 2014b). From the Modesto Downtown Transit Center, passengers can transfer to buses on Route 10 Express to Turlock; Route 15 to Ceres, Keyes, and Turlock; and Route 60 to Riverbank and Oakdale, as well as to the Modesto Amtrak station, the ACE train station in Lathrop, and the Dublin BART station (City of Modesto 2009; Stanislaus Regional Transit 2014c). From the Patterson Transfer Location at Veteran’s Memorial Park, passengers can transfer to buses on Route 45 East, which travels between Patterson and Turlock, and Route 45 West, which connects Patterson to Crows Landing, Newman, and Gustine (Stanislaus Regional Transit 2014c). Westley has three StaRT bus stops, one at C Street and SR 33, one at Howard Road and Livingston Circle, and a third at Griscott Way and Walt Avenue (Stanislaus Regional Transit 2014b).

## 2.7.4 Water, Wastewater, and Stormwater Drainage Systems

Water and wastewater services in Westley are provided by the Westley CSD and the Stanislaus County Housing Authority. The Stanislaus County Housing Authority operates a wastewater treatment facility that serves the Housing Authority’s Westley Migrant Center complex and provides sewer service to the Westley CSD on a contractual basis (Stanislaus Local Agency Formation Commission 2014). Although the CSD currently meets the needs of its customers, major repairs to the existing sewer lift station and two pumps will be necessary in the near future (Stanislaus Local Agency Formation Commission 2014). Furthermore, the two groundwater wells serving the DUC have both recently required improvements and the wastewater treatment plant is operating at capacity. The Housing Authority also provides municipal water service within the Westley CSD boundaries via two groundwater wells (Stanislaus Local Agency Formation Commission 2014). The CSD’s infrastructure is aging and in need of system-wide improvements (Stanislaus Local Agency Formation Commission 2014). Although streets within the Migrant Center complex have gutters, no gutters are present within the rest of Westley. Drainage in Westley is provided by rock wells in fair condition; no pipelines or detention ponds are present (Stanislaus County 2004).

## 2.7.5 Solid Waste Disposal

Stanislaus County contracts with four franchised solid waste collection companies, Bertolotti Disposal, Gilton Solid Waste, Modesto Disposal/Waste Management, and Turlock Scavenger, for residential and commercial garbage collection service in the unincorporated area (Stanislaus County 2014a). Westley falls within County-designated Franchise Area 1, served by Bertolotti Disposal (Stanislaus County 2014b). Besides providing solid waste and recyclables collection services to Franchise Area 1, Bertolotti Disposal operates a transfer station, open to the public Mondays through Saturdays, on Flamingo Road in Ceres. Additionally, Stanislaus County's Fink Road Sanitary Landfill, a Class III landfill for nonhazardous municipal solid waste, is operated by the County's Department of Environmental Resources and is open Monday through Saturday to private citizens, school districts, businesses, and local agencies for individual disposal of solid waste (Stanislaus County 2014c).

## 2.7.6 Law Enforcement and Fire Protection

Law enforcement services for Westley, as for the rest of unincorporated Stanislaus County and four contract cities, are provided by the Stanislaus County Sheriff's Department. The operations division of the Sheriff's Department provides law enforcement services to over 200,000 people in a 1,521-square-mile area (Stanislaus County Sheriff's Department 2014). Two units—patrol and investigations—comprise the Sheriff's Department operations division. The patrol unit responds to calls for assistance, investigates crime, makes arrests, and performs preventive patrol services (Stanislaus County Sheriff's Department 2014). The investigations unit follows up reports of major crimes, collects and prepares evidence for trials, apprehends offenders, and recovers stolen property (Stanislaus County Sheriff's Department 2014).

The nearest sheriff's station to Westley is the main station, approximately 12.5 miles east at 250 East Hackett Road in Ceres. In addition, the Patterson police station, located approximately 6 miles south of Westley in the city of Patterson, is staffed by the Stanislaus County Sheriff's Department, which provides contract police services to Patterson under the title of Patterson Police Services (Stanislaus Local Agency Formation Commission 2013).

The crime rates presented below were compiled by AGS using the primary reporting categories from the FBI 2005 – 2010 Uniform Crime Report databases along with preliminary 2011 release data and census data related to socioeconomic characteristics. The crimes are divided into two main categories, personal crimes (murder, rape, robbery, and assault) and property crimes (burglary, larceny, and motor vehicle theft). These crime rates are based on a comparison of the average local crime rate to the national average for the same crime, with a crime index of 100 considered average; scores above 100 are therefore considered greater, or worse, than average. For example, a score of 130 would represent a crime rate 30% greater than the national average for that type of crime. These crime rates are unweighted (i.e., a murder and a theft carry the same weight for calculation purposes), and are tracked at the census block group level and above, which may not correspond precisely to the DUC boundaries. Census blocks are the smallest geographic area for which the United States Census Bureau collects and tabulates data; a set of these constitutes a census block group. Census blocks vary widely in geographic size, and are generally smaller in urban areas and progressively larger in suburban, rural, or remote areas; a given block group is larger in area and population than the individual census blocks of which it is made, and generally contains between

600 and 3,000 people (United States Census Bureau 1994). The Westley DUC falls within census block group 060990033.001.

Both the overall personal crime and property crime indices for Westley are 168, which means that personal and property crimes occur at a rate 68% higher than the national average. The general and individual crime indices for these categories are shown in Table 2-25 below.

**Table 2-25. Westley Crime Indices**

Personal Crime		Property Crime	
Personal Crime Index	168	Property Crime Index	168
Murder	86	Burglary	347
Rape	112	Larceny	157
Robbery	60	Motor Vehicle Theft	35
Assault	348		

Source: Applied Geographic Solutions and Atlas Publishing 2012.

The West Stanislaus County FPD provides fire protection, emergency, and rescue services to the community of Westley, as well as to Grayson, Crows Landing, and Diablo Grande (Emergency Services Consulting 2007). The West Stanislaus County FPD's Fire Station No. 3 is located in Westley, at 8598 Kern Street, and houses WSF-Engine 3, WSF-Water Tender 3, and WSF-Rescue 3 (West Stanislaus County Fire Protection District 2014). District-wide, 5 full-time firefighters per shift and 100 volunteers staff the West Stanislaus County FPD; the Westley Station is staffed entirely by volunteer firefighters (Stanislaus Local Agency Formation Commission 2007; West Stanislaus County Fire Protection District 2014).

A fire department's ability to meet the fire protection needs of its service area is typically evaluated by the Insurance Services Office (ISO), a private organization that assesses risks, including fire protection, for insurance purposes. The ISO considers a variety of factors, including a district's fire-fighting apparatus, staffing, training, location, and water supply, to rate fire departments on a scale from 1 (best fire protection possible) to 10 (no fire protection). The ISO rating therefore reflects a fire department's ability to protect the residents and businesses within its service area from fire. The West Stanislaus County FPD carries an ISO rating of 4 (West Stanislaus Fire Protection District 2015).

## 2.7.7 Schools and Community Amenities

Westley lies within the boundaries of the Patterson Unified School District, which includes a total of 8 schools serving 6,023 students in grades K–12 (Stanislaus County Office of Education 2009; California Department of Education 2014e). One elementary school, Grayson Charter, is located in Westley. Grayson Charter provides a dual-language immersion program in English and Spanish to 262 children in grades K–5 (California Department of Education 2014b). The nearest non-charter elementary school is Northmead Elementary, located approximately 5 miles south in Patterson. Northmead Elementary serves 572 students in grades K–5 (California Department of Education 2014c). The nearest middle school to Westley is Creekside Middle School in Patterson, serving 1,201 students in grades 6–8 (California Department of Education 2014a). The nearest high school to

Westley is Patterson High School, located approximately 6 miles southwest in Patterson and serving 1,690 students in grades 9–12 (California Department of Education 2014d).

No public parks are present in Westley; however, three are located approximately 2 miles east of Westley in the nearby community of Grayson. The three facilities in Grayson include Leroy F. Fitzsimmons Memorial Park, United Community Center and Park, and Laird Regional Park. The 0.5-acre Leroy F. Fitzsimmons Memorial Park has a basketball court, picnic shelter, tables and playground equipment (Stanislaus County n.d.). The 5-acre United Community Center and Park features a 3,165 square-foot community center building, play equipment, an amphitheater lawn area, barbecues and picnic tables, basketball courts, and informal play areas (Stanislaus County n.d.). Laird Park is a 97-acre regional park approximately 2 miles east of Grayson on the San Joaquin River. Laird Park features a baseball/softball field, a soccer field, informal play areas, picnic shelters with picnic tables and barbecues, river access, and an unpaved parking area (Stanislaus County n.d.). No restrooms are available at either Fitzsimmons or Laird Park (Stanislaus County n.d.). The Stanislaus County Department of Parks and Recreation's Community Parks Division operates and maintains these parks. In addition, Grayson Charter School has ball fields and basketball courts. The Westley Migrant Center immediately southwest of the Westley DUC has a community center and age-separated playground equipment.

Westley has two grocery stores, El Mercadito and the Westley Market/El Paisano Supermarket, both on Highway 33. In addition, the One-Stop Market, a small convenience market with gas pumps and a laundromat, is located approximately 2 miles northeast of Westley in the community of Grayson.

## 2.7.8 Air Quality and Chronic Health Conditions

Stanislaus County is within the northern part of the eight-county SJVAPCD, a regional public health agency responsible for air quality management in those eight counties. SJVAPCD cites several factors that contribute to the valley's air quality challenges, including high rates of chronic poverty and unemployment coupled with a high population growth rate, the presence of major transportation corridors, and topographic features such as the surrounding mountains combined with the area's meteorological conditions (San Joaquin Valley Air Pollution Control District 2014a). SJVAPCD notes that ozone, PM10, and PM2.5 are of special concern, causing or exacerbating a variety of health conditions (San Joaquin Valley Air Pollution Control District 2014a). The presence of PM2.5, primarily a winter condition, triggers heart attacks, asthma, bronchitis, and respiratory infections, and has a strong correlation with hospital admissions and deaths (San Joaquin Valley Air Pollution Control District 2014a).

GHGs are not a criteria air pollutant and do not directly affect human health. GHG emissions are largely the result of combustion, decay and digestive processes, and emissions of industrial gases with high climate change potential. Unlike criteria pollutants such as carbon monoxide, PM10, PM2.5, and ozone, GHGs do not collect within a specific area or air basin. Their harm is done at a global level through the effect of increased concentrations of GHGs in Earth's atmosphere.

Worldwide concern over GHG emissions is based on the climate change that they are causing by altering the way in which Earth's atmosphere traps solar radiation as heat. The adverse effects of global climate change include rising sea levels, changes in habitat conditions for plants and animals, increased potential for wildfires, more severe weather extremes, and a reduction in California's winter snow pack, among others. Through the impetus of AB 32 (California Global Warming

Solutions Act of 2006) and other legislation, California has undertaken a statewide program of reducing GHG emissions to 1990 levels by 2020 in order to slow the rate of global climate change.

Climate change can have an indirect effect on human health in Stanislaus County to the extent that it results in warmer summer temperatures that facilitate ozone formation and exacerbate heat-related stress among outdoor workers, the elderly, small children, and the infirm. The amount of GHGs emitted within the Westley DUC is not atypical for a small community.

SJVAPCD operates 36 air monitoring sites within its eight-county air basin. Of these, two air quality stations, one in Modesto and another in Turlock, monitor air quality within Stanislaus County. At a distance of 13 miles to the northeast, the Modesto monitoring site is the closest to Westley. Table 2-26 shows the SJVAB's current air quality attainment status for state and federal criteria pollutants (San Joaquin Valley Air Pollution Control District 2012).

**Table 2-26. San Joaquin Valley Air Basin Air Quality Attainment Status**

Pollutant	Designation/Classification	
	Federal Standards	State Standards
Ozone—1-hour	No Federal Standard <sup>a</sup>	Nonattainment/Severe
Ozone—8-hour	Nonattainment/Extreme <sup>b</sup>	Nonattainment
PM 10	Attainment <sup>c</sup>	Nonattainment
PM 2.5	Nonattainment <sup>d</sup>	Nonattainment
Carbon monoxide	Attainment/Unclassified	Attainment/Unclassified
Nitrogen dioxide	Attainment/Unclassified	Attainment
Sulfur dioxide	Attainment/Unclassified	Attainment
Lead (particulate)	No Designation/Classification	Attainment
Hydrogen sulfide	No Federal Standard	Unclassified
Sulfates	No Federal Standard	Attainment
Visibility reducing particles	No Federal Standard	Unclassified
Vinyl chloride	No Federal Standard	Attainment

Source: San Joaquin Valley Air Pollution Control District 2012.

<sup>a</sup> Effective June 15, 2005, the U.S. Environmental Protection Agency (EPA) revoked the federal 1-hour ozone standard, including associated designations and classifications. EPA had previously classified the San Joaquin Valley air basin (SJVAB) as extreme nonattainment for this standard. EPA approved the 2004 Extreme Ozone Attainment Demonstration Plan on March 8, 2010 (effective April 7, 2010). Many applicable requirements for extreme 1-hour ozone nonattainment areas continue to apply to the SJVAB.

<sup>b</sup> Though the SJVAB was initially classified as serious nonattainment for the 1997 8-hour ozone standard, EPA approved SJVAB reclassification to extreme nonattainment in the Federal Register on May 5, 2010 (effective June 4, 2010).

<sup>c</sup> On September 25, 2008, EPA redesignated the SJVAB to attainment for the PM10 National Ambient Air Quality Standard (NAAQS) and approved the PM10 Maintenance Plan.

<sup>d</sup> The SJVAB is designated nonattainment for the 1997 PM2.5 NAAQS. EPA designated the SJVAB as nonattainment for the 2006 PM2.5 NAAQS on November 13, 2009 (effective December 14, 2009).

Over the past decade, ozone levels have been trending downward within the SJVAB and, in 2013, for the first time on record, the air basin overall had zero violations of the federal hourly ozone

standard, compared to 281 violations in 1996 (San Joaquin Valley Air Pollution Control District 2014b). At the same time, PM<sub>2.5</sub> and PM<sub>10</sub> levels have fluctuated with no clear upward or downward trend (California Air Resources Board 2015). Table 2-27 presents the number of days in which Stanislaus County ozone, PM<sub>2.5</sub>, and PM<sub>10</sub> levels exceeded state and federal air quality standards in 2013 (California Air Resources Board 2015).

**Table 2-27. Stanislaus County Days in Exceedance of State and Federal Air Quality Standards, 2013**

Monitoring Site	Ozone			PM 2.5	PM 10
	# Days > State 1-Hr Standard	# Days > National '08 8-Hr Standard	# Days > State 8-Hr Standard	Est Days > National 24-Hr Standard	Est Days > State 24-Hr Standard
Modesto 14th St.	0	2	13	37.6	57.7
Turlock S. Minaret St.	1	14	24	40.3	73.7

Source: California Air Resources Board 2015.

The 2013 CHA, prepared by the Stanislaus County Health Services Agency, presents data about the health and well-being of Stanislaus County residents, including information on the burden of five major chronic diseases—hypertension, heart disease, stroke, diabetes and asthma—and the environmental and behavioral factors that influence their prevalence. Primary environmental factors identified in the CHA as contributing to these chronic health conditions are air quality and retail food environment; behavioral factors include diet, fast food consumption, fruit and vegetable consumption, quality of clinical care, physical activity, obesity, and tobacco use (Stanislaus County Health Services Agency 2013). As measured in 2007, Stanislaus County has the second worst retail food environment in California, with 5.48 fast-food purveyors and convenience stores for every grocery store or produce vendor near residences, compared to 4.48 statewide, and a high rate of fast food consumption in the low income population (Stanislaus County Health Services Agency 2013). The county also has the highest prevalence of obesity in the state (31.5% compared to 21.2% statewide), particularly among males, and a higher percentage of smokers than the California average (Stanislaus County Health Services Agency 2013).

The CHA presents countywide data and also divides Stanislaus County into nine geographic regions, shown in Table 2-28 below. Westley falls within the west side region identified in Table 2-28.



**Table 2-28. Community Health Assessment of Stanislaus County Geographic Regions**

Region	Communities
Central	Modesto (parts) and outlying areas with ZIP codes 95350, 95355, 95357, and 95358
East Central	Airport Neighborhood and East Modesto (parts) with ZIP code 95354
Southeast Side	Denair, Empire, Hughson, Hickman, La Grange, Waterford with ZIP codes 95316, 95319, 95326, 95323, 95329, and 95386
Northeast Side	Knights Ferry, Valley Home, Oakdale, Riverbank with ZIP codes 95230, 95361, and 95367
North Side	Del Rio, Salida and Modesto (parts) with ZIP codes 95356 and 95368
Southwest Central	West Modesto and South Modesto with ZIP code 95351
West Side	Crows Landing, Grayson, Newman, Patterson, Westley with ZIP codes 95313, 95360, 95363, 95385, and 95387
South Central	Ceres, Keyes with ZIP codes 95307 and 95328
South Side	Turlock with ZIP codes 95380 and 95382

Source: Stanislaus County Health Services Agency 2013:Table 2.

Chronic health conditions of concern within Stanislaus County include hypertension, heart disease, stroke, diabetes and asthma. According to the CHA, the percentage of Stanislaus adults diagnosed with high blood pressure increased 31.2% between 2001 and 2009, and surpassed the percentage of California adults diagnosed with high blood pressure use. As of 2009, approximately 30.7% of Stanislaus County adults were diagnosed with hypertension, compared to 26.2% statewide. Among Stanislaus County's nine regions, the west side, including Westley, has the lowest rate of hypertension-related emergency room visits, ranks fifth for hypertension-related hospitalizations, and has the second-lowest hypertension-related mortality rate (Stanislaus County Health Services Agency 2013).

The CHA notes that in 2009, 5% of Stanislaus County adults had been diagnosed with heart disease, compared to 5.9% statewide and 12% of adults nationwide. Stanislaus County's west side has the second-lowest rate among the nine regions for heart disease-related emergency room visits, the lowest rate of heart disease-related hospitalizations, and the fourth-highest mortality rate among the county's nine regions (Stanislaus County Health Services Agency 2013).

The CHA indicates that the California Health Interview Survey, on which it relies for some data, has not consistently tracked either the overall prevalence of cancer or the rates of individual types of cancer; data for cancer rates is therefore less current than for other, more closely tracked, conditions. Although the percentage of Stanislaus County adults diagnosed with cancer has increased from 7.4% in 2001 to 8.5% in 2005, it remains lower than the statewide rate. However, at a rate of approximately 21.4% of all deaths annually, cancer is the second most common cause of death in Stanislaus County. The west side of Stanislaus County ranks seventh (third-lowest) among the nine regions for cancer-related emergency room visits, has the lowest rate of cancer-related hospitalizations, and has the highest rate of cancer-related mortality (Stanislaus County Health Services Agency 2013).

Diabetes, according to the CHA, affects 8.3% of the United States population and is the seventh leading cause of death nationwide. Within California, from 2001-2007, the percentage of people diagnosed with diabetes increased from 6.2% to 8.5%, a 37% increase. Trends in Stanislaus County

are consistent with the statewide increase; in 2009, 7.6% of adults in Stanislaus County had been diagnosed with diabetes. While the prevalence of diabetes was lower in Stanislaus County than California, in 2011, Stanislaus County had higher hospitalization rates than California for four primary indicators of diabetes management, including hospitalization for short-term complications, long-term complications, lower-extremity amputation, and uncontrolled diabetes (Stanislaus County Health Services Agency 2013). Among Stanislaus County's nine regions, the west side has the lowest rate of diabetes-related emergency room visits, the third-lowest rate of hospitalizations, and the highest rate of diabetes-related mortality (Stanislaus County Health Services Agency 2013).

According to the CHA, in 2009 the percentage of Stanislaus County adults diagnosed with asthma was 21.8%, compared to 13.5% of the adult population statewide. The west side region has Stanislaus County's second-lowest rate of asthma-related emergency room visits and hospitalizations among the nine regions (Stanislaus County Health Services Agency 2013). Due to the low asthma-related death rate, the CHA does not track or rank asthma-related mortality.

The CHA also uses LEB as a measure of quality of life within Stanislaus County and each of its nine regions. LEB is defined as the number of years a newborn infant is projected to live if mortality patterns at the time of its birth were to remain the same throughout its life. The LEB for Stanislaus County is calculated to be 77.2 years, 1.7 years less than the nationwide LEB of 78.9. The LEBs within the nine Stanislaus County regions range from a high of 80.27 years to a low of 75.01 years; the west side region ranks third-highest among these, with a LEB of 79.58 years (Stanislaus County Health Services Agency 2013).

## 2.7.9 References

- Applied Geographic Solutions and Atlas Publisher. 2012. Crime Index for the U.S. Retrieved through ArcGIS. Available: [http://megacity.esri.com/ArcGIS/rest/services/Demographics/USA\\_CrimeIndex/MapServer](http://megacity.esri.com/ArcGIS/rest/services/Demographics/USA_CrimeIndex/MapServer). Accessed: 2012.
- California Air Resources Board. 2015. *Select 8 Summary*. Available: <http://www.arb.ca.gov/adam/select8/sc8start.php>. Accessed: January 22, 2015.
- California Department of Conservation. 2012. Division of Land Resource Protection. *Stanislaus County Williamson Act FY 2010/2011, Sheet 1 of 2*. Available: [ftp://ftp.consrv.ca.gov/pub/dlrp/wa/stanislaus\\_north\\_10\\_11\\_WA.pdf](ftp://ftp.consrv.ca.gov/pub/dlrp/wa/stanislaus_north_10_11_WA.pdf). Accessed: January 16, 2015.
- California Department of Conservation. 2014. Division of Land Resource Protection. *Rural Land Mapping Edition, Stanislaus County Important Farmland 2012, Sheet 1 of 2*. Available: [ftp://ftp.consrv.ca.gov/pub/dlrp/FMMP/pdf/2012/sta12\\_no.pdf](ftp://ftp.consrv.ca.gov/pub/dlrp/FMMP/pdf/2012/sta12_no.pdf). Accessed: January 16, 2015.
- California Department of Education. 2014a. *Creekside Middle School Profile: Fiscal Year 2013–14*. Available: [http://www.ed-data.k12.ca.us/App\\_Resx/EdDataClassic/fsTwoPanel.aspx?#!bottom=/layouts/EdDataClassic/profile.asp?Tab=0&level=07&reportnumber=16&county=50&district=71217&school=6060297](http://www.ed-data.k12.ca.us/App_Resx/EdDataClassic/fsTwoPanel.aspx?#!bottom=/layouts/EdDataClassic/profile.asp?Tab=0&level=07&reportnumber=16&county=50&district=71217&school=6060297). Accessed: November 19, 2014.

- California Department of Education. 2014b. *Grayson Charter School Profile: Fiscal Year 2013–14*. Available: [http://www.ed-data.k12.ca.us/App\\_Resx/EdDataClassic/fsTwoPanel.aspx?#!bottom=/layouts/EdDataClassic/profile.asp?tab=1&level=07&ReportNumber=16&County=50&fyr=1314&District=71217&School=6052922](http://www.ed-data.k12.ca.us/App_Resx/EdDataClassic/fsTwoPanel.aspx?#!bottom=/layouts/EdDataClassic/profile.asp?tab=1&level=07&ReportNumber=16&County=50&fyr=1314&District=71217&School=6052922). Accessed: November 19, 2014.
- California Department of Education. 2014c. *Northmead Elementary School Profile: Fiscal Year 2013–14*. Available: [http://www.ed-data.k12.ca.us/App\\_Resx/EdDataClassic/fsTwoPanel.aspx?#!bottom=/layouts/EdDataClassic/profile.asp?tab=0&level=07&ReportNumber=16&County=50&fyr=1314&District=71217&School=6052955](http://www.ed-data.k12.ca.us/App_Resx/EdDataClassic/fsTwoPanel.aspx?#!bottom=/layouts/EdDataClassic/profile.asp?tab=0&level=07&ReportNumber=16&County=50&fyr=1314&District=71217&School=6052955). Accessed: November 19, 2014.
- California Department of Education. 2014d. *Patterson High School Profile: Fiscal Year 2013–14*. Available: [http://www.ed-data.k12.ca.us/App\\_Resx/EdDataClassic/fsTwoPanel.aspx?#!bottom=/layouts/EdDataClassic/profile.asp?tab=0&level=07&ReportNumber=16&County=50&fyr=1314&District=71217&School=5036256](http://www.ed-data.k12.ca.us/App_Resx/EdDataClassic/fsTwoPanel.aspx?#!bottom=/layouts/EdDataClassic/profile.asp?tab=0&level=07&ReportNumber=16&County=50&fyr=1314&District=71217&School=5036256). Accessed: November 19, 2014.
- California Department of Education. 2014e. *Patterson School District Profile: Fiscal Year 2013–14*. Available: [http://www.ed-data.k12.ca.us/App\\_Resx/EdDataClassic/fsTwoPanel.aspx?#!bottom=/layouts/EdDataClassic/profile.asp?tab=1&level=06&ReportNumber=16&County=50&fyr=1314&District=71217](http://www.ed-data.k12.ca.us/App_Resx/EdDataClassic/fsTwoPanel.aspx?#!bottom=/layouts/EdDataClassic/profile.asp?tab=1&level=06&ReportNumber=16&County=50&fyr=1314&District=71217). Accessed: November 19, 2014.
- City of Modesto. 2009. *Modesto Area Express: ACE, Amtrak, BART*. Available: <http://www.modestoareaexpress.com/commuter/>. Accessed: July 10, 2014.
- Emergency Services Consulting. 2007. *Stanislaus LAFCO Countywide Fire Services Municipal Service Review*. Final Report. March 2007. Prepared for Stanislaus Local Agency Formation Commission. Available: <http://www.stanislauslafco.org/info/FireMSR.htm>. Accessed: August 26, 2014.
- Great Circle Mapper. 2015. *CA-67 Airport*. Available: <http://www.gcmap.com/airport/CA67>. Accessed: January 9, 2015.
- San Joaquin Valley Air Pollution Control District. 2012. *Ambient Air Quality Standards & Valley Attainment Status*. Available: <http://www.valleyair.org/aqinfo/attainment.htm>. Accessed: January 22, 2015.
- San Joaquin Valley Air Pollution Control District. 2014a. *Air Quality in the San Joaquin Valley*. Available: <http://www.valleyair.org/kids/docs/Generalpptforwebsite-2014.pdf>. Accessed: January 22, 2015.
- San Joaquin Valley Air Pollution Control District. 2014b. *Report to the Community, 2013–14 Edition*. Available: <http://www.valleyair.org/2013-14-AnnualReport.pdf>. Accessed: January 22, 2015.
- Stanislaus Council of Governments. 2014. *2014 Regional Transportation Plan / Sustainable Communities Strategy, Stanislaus County*. June 2014. Available: <http://www.stancog.org/pdf/rtp/final-2014-rtpscs.pdf>. Accessed: December 3, 2014.
- Stanislaus County. 2004. *Storm Water Management Program for Stanislaus County*. Available: <http://www.stancounty.com/publicworks/storm/pdf/sw-management-plan.pdf>. Accessed: December 10, 2014.

- Stanislaus County. 2012. *Stanislaus County General Plan Housing Element 2009-2014*. Adopted August 28, 2012.
- Stanislaus County. 2014a. *Solid Waste Management*. Available: <http://www.stancounty.com/ER/solid-waste-ordinance.shtm>. Accessed: November 18, 2014.
- Stanislaus County. 2014b. *Solid Waste Management Franchise Area Map*. Available: <http://www.stancounty.com/ER/pdf/rates/franchiseareamap.pdf>. Accessed: November 18, 2014.
- Stanislaus County. 2014c. *Landfill Division: Fink Road Sanitary Landfill*. Available: <http://www.stancounty.com/ER/landfill-division.shtm>. Accessed: November 18, 2014.
- Stanislaus County. No Date. *Community Parks, Facilities, and Fishing Accesses*. Available: <http://www.stancounty.com/er/parks/pdf/community-parks-brochure.pdf>. Accessed: December 10, 2014.
- Stanislaus County Health Services Agency. 2013. *2013 Stanislaus County Community Health Assessment*.
- Stanislaus County Office of Education. 2009. *Patterson Joint Unified School District Map*. Available: [http://www.stancoe.org/scoe/resources/district\\_maps/Patterson\\_JUSD.pdf](http://www.stancoe.org/scoe/resources/district_maps/Patterson_JUSD.pdf). Accessed: November 19, 2014.
- Stanislaus County Sheriff's Department. 2014. *Operations Division*. Available: <http://www.scsdonline.com/operations-division/>. Accessed: November 21, 2014.
- Stanislaus Local Agency Formation Commission. 2007. *Countywide Fire Services Municipal Service Review*. Available: <http://www.stanislauslafco.org/info/PDF/FireMSR/CoverContents.pdf>. Accessed: December 10, 2014.
- Stanislaus Local Agency Formation Commission. 2013. *Municipal Service Review/Sphere of Influence Plan, City of Patterson, Stanislaus County, California*. Available: <http://www.stanislauslafco.org/info/pdf/msr/patterson.pdf>. Accessed: December 2, 2014.
- Stanislaus Local Agency Formation Commission. 2014. *Municipal Service Review and Sphere Of Influence Update For: Crows Landing, Grayson, and Westley Community Services Districts*. Available: <http://www.stanislauslafco.org/info/PDF/MSR/Districts/CrowsLGraysonWestleyCSD.pdf>. Accessed: December 10, 2014.
- Stanislaus Regional Transit. 2014a. *System Maps and Quick Guide*. Available: [http://www.srt.org/start\\_system\\_maps2.html](http://www.srt.org/start_system_maps2.html). Accessed: December 23, 2014.
- Stanislaus Regional Transit. 2014b. *Stanislaus Regional Transit – Route 40*. Available: [http://www.srt.org/route\\_40.html](http://www.srt.org/route_40.html). Accessed: July 10, 2014.
- Stanislaus Regional Transit. 2014c. *Stanislaus Regional Transit System Map - Fixed Routes, Shuttles, Runabout & Dial-A-Rides*. Available: [http://www.srt.org/start\\_system\\_maps2.html](http://www.srt.org/start_system_maps2.html). Accessed: December 23, 2014.
- United States Census Bureau. 1994. *Geographic Areas Reference Manual*. Available: <https://www.census.gov/geo/reference/garm.html>. Accessed: December 8, 2014.

United States Census Bureau. 2013a. *American Fact Finder DP-1, Profile of General Population and Housing Characteristics 2010, Westley CDP, California*. Available:

<http://factfinder.census.gov/faces/nav/jsf/pages/inex.xhtml>. Accessed: July 10, 2014.

United States Census Bureau. 2013b. *American Fact Finder DP03, Selected Economic Characteristics, 2009-2013 American Community Survey 5-Year Estimates, Westley CDP, California*. Available:

<http://factfinder.census.gov/faces/nav/jsf/pages/inex.xhtml>. Accessed: July 10, 2014.

West Stanislaus Fire Protection District. 2014. Fire Station 3-Westley. Available:

<http://www.weststanfire.org/fire-station-3/>. Accessed: November 21, 2014.

West Stanislaus Fire Protection District. 2015. *ISO Rating Update*. Available:

<http://www.weststanfire.org/iso-rating-update/>. Accessed: June 1, 2015.

***THIS PAGE INTENTIONALLY LEFT BLANK***

The following discusses the needs of Stanislaus County's seven DUCs.

### **3.1 Cowan Tract DUC**

The Cowan Tract DUC lacks curbs, gutters, sidewalks, streetlights, and a storm drainage system. Water is supplied through individual private wells and wastewater is disposed through private septic systems. These could be provided by a CSD; however, no such district exists in this DUC. Funding of improvements from benefit assessments or other property-based revenue sources would be problematic in Cowan Tract given its low median income.

### **3.2 Crows Landing DUC**

Most of the Crows Landing DUC lacks curbs, gutters, sidewalks, and streetlights. There is no storm drainage system. Wastewater in Crows Landing is processed through individual private septic systems. The existing water supply system, although in the process of being upgraded, relies on an aging system of pipelines that does not provide adequate water pressure during periods of peak demand. Although the Crows Landing CSD was recently granted up to \$20,000 from the Stanislaus County Community Development Fund to assist in the repair of a corroded well, the CSD has limited financial resources to address existing water supply system deficiencies. Funding of improvements from benefit assessments or other property-based revenue sources would be problematic in Cowan Tract given its low median income.

### **3.3 Grayson DUC**

This DUC has adequate infrastructure and services, with the exception of the water supply system. Specific water supply system deficiencies include the pumping capacity of the two wells and areas of the distribution system in which minimum water pressure could not be maintained. Funding of improvements from benefit assessments or other property-based revenue sources would be problematic in Grayson DUC given its low median income. Further, the City of Modesto applied unsuccessfully, in 2014, to the California Department of Water Resources for an Expedited Drought Grant to implement the needed improvements.

### **3.4 Keyes DUC**

Curbs, gutters, sidewalks, and streetlights are absent in small portions of the Keyes DUC. Areas outside the Keyes CSD, including two mobile home parks, are not served by public water, sewer, or storm drainage systems. Funding of improvements from benefit assessments or other property-based revenue sources would be problematic in the Keyes DUC given its low median income.

### 3.5 Monterey Park Tract DUC

No sidewalks, curbs, or gutters exist within Monterey Park Tract DUC, and there is no storm drainage system. The Monterey Park Tract CSD provides the DUC with domestic water from two groundwater wells and, due to a history of poor water quality and continuing contamination, is in the process of constructing a new water delivery system that will utilize water from the City of Ceres. Wastewater is disposed through private septic systems. In addition, portions of the DUC are without street lights. Monterey Park Tract lacks public bus service. Funding of improvements from benefit assessments or other property-based revenue sources would be problematic in Monterey Park Tract given its low median income and lack of a CSD.

### 3.6 Riverdale Park Tract DUC

There are no curbs, gutters, sidewalks, or streetlights in this DUC. The Riverdale Park Tract CSD serves only the northern portion of the Riverdale Park Tract CDP that is within the sphere of influence of the City of Modesto. As a result, the DUC has no CSD and relies on private wells and private septic systems. Further, there is no storm drainage system. Most of the Riverdale Park Tract DUC also lacks public bus service.

At the present time, the nearby Riverdale Park Tract CSD appears to have limited financial resources to operate the domestic water system within its territory. The potential to expand the CSD to cover the DUC is limited in that future funding of improvements from benefit assessments or other property-based revenue sources would be problematic in the Riverdale Park Tract DUC given its low median income.

### 3.7 Westley DUC

Curbs, gutters, sidewalks, and streetlights are absent in portions of the Westley DUC. There is no storm drainage system. The Westley CSD contracts with the Stanislaus County Housing Authority for water and wastewater services; the Stanislaus County Housing Authority also serves the area outside the Westley CSD. Although the CSD currently meets the needs of its customers, major repairs to the existing sewer lift station and two pumps will be necessary in the near future. Furthermore, the two groundwater wells serving the DUC have both recently required improvements and the wastewater treatment plant is operating at capacity. The CSD's infrastructure is aging and in need of system-wide improvements (Stanislaus Local Agency Formation Commission 2014). Funding of improvements from benefit assessments or other property-based revenue sources would be problematic in the Westley DUC given its low median income.



In general, the Stanislaus County DUCs lack certain community infrastructure, water and sewer service, and access to transit and full-service grocery stores. As described in Chapter 2, Existing Conditions, the Stanislaus County Health Services Agency’s 2013 *Community Health Assessment of Stanislaus County* (CHA) indicates a correlation between poor infrastructure, particularly accessibility, and an unhealthy population. The CHA notes that Stanislaus County has the second worst retail food environment in California, a high rate of fast food consumption in the low income population, the highest prevalence of obesity in the state, and a higher percentage of smokers (Stanislaus County Health Services Agency 2013). The CHA identifies air quality and retail food environment (access to healthy food) as primary environmental factors contributing to several chronic health conditions prevalent in Stanislaus County, including hypertension, heart disease, stroke, diabetes, and asthma (Stanislaus County Health Services Agency 2013).

Infrastructure improvements and other strategies to address these issues will improve conditions within the DUCs over the long term.

The proposed General Plan update includes the following policies and implementation measures as strategies to address DUC deficits.

## 4.1 Land Use Element

**POLICY SIX:** Preserve and encourage upgrading of existing unincorporated urban communities. [existing policy]

IMPLEMENTATION MEASURE 1: The County shall support State efforts to reestablish redevelopment tools utilizing tax increment for the purpose of upgrading existing unincorporated communities. [amended measure]

IMPLEMENTATION MEASURE 2: The County will apply for federal and state funds to aid in upgrading existing urban areas. [existing measure]

IMPLEMENTATION MEASURE 4: When feasible, new development shall be designed and built to allow for the upgrading or expansion of services necessary to upgrade existing unincorporated urban communities; however, new development will not be expected to be financially responsible for providing upgrades. [new measure]

IMPLEMENTATION MEASURE 5: The County shall support and assist unincorporated urban communities in their efforts to establish “self-help” programs (such as assessment financing districts) necessary to upgrade their communities. [new measure]

IMPLEMENTATION MEASURE 6: As part of the environmental work the County will review, and if necessary, amend the General Plan to address the infrastructure, housing and public health needs to assist in transforming identified disadvantaged communities into healthy communities. [new measure]

**POLICY TWENTY-THREE:** Future growth shall not exceed the capabilities/capacity of the provider of services such as sewer, water, public safety, solid waste management, road systems, schools, health care facilities, etc. [existing policy]

**IMPLEMENTATION MEASURE 6:** Rezoning of property prior to: 1) annexation to a special district; 2) inclusion of such property into a newly formed special district, or community service district shall be approved only if the development is adequately conditioned to restrict development from occurring until annexation to or formation of the required district is complete. [amended policy]

**POLICY THIRTY:** The County shall support efforts to improve local health care options through the siting of new facilities in locations with the infrastructure (including, but not limited to, transportation and utility) to support both facility and client needs. [new policy]

## 4.2 Circulation Element

**POLICY EIGHT:** Promote public transit as a viable transportation source. [Existing policy]

**IMPLEMENTATION MEASURE 1:** Continue to operate existing transit systems and coordinate with other County transit operators to provide public transit serving Stanislaus County. [amended policy]

**IMPLEMENTATION MEASURE 6:** Where possible, coordinate public transportation with land use planning, transportation planning, and air quality policies such that transit investments are complementary to land use planning and air quality policies. [new policy]

**IMPLEMENTATION MEASURE 9:** The County shall encourage infill development of vacant parcels and redevelopment projects that will align with and improve the overall effectiveness of the public transit system. [new policy]

## 4.3 Additional Policies

Although deficits are identified in Chapter 3, improvements to existing infrastructure are either in process, under the jurisdiction of the appropriate CSDs, or are not viable due to location, funding, and other constraints. In some cases, the locations of DUCs preclude connections to existing municipal water and wastewater services; in nearly all cases, the cost of providing such services to these locations is prohibitive. As identified in the Municipal Service Reviews for the relevant CSAs and CSDs, funding opportunities for infrastructure improvements in the DUCs are limited because of the low assessed values of the properties within the DUCs. The low values would not support sufficient benefit assessments or special taxes to finance the needed improvements and continued maintenance and operation of infrastructure. The existing and proposed amended General Plan policies and implementation measures outlined above adequately address the needs of the identified DUCs to the extent that improvements are viable, and no additional policies or implementation measures are necessary.